

MONROE®

MAXLIFT®

GAS CHARGED LIFT SUPPORT

2017

MASTER CATALOGUE

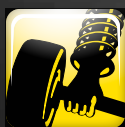

Online E-Catalogue:
www.monroecatalogue.eu



EMEA

TENNECO

www.monroe.com



MONROE

TOTAL SOLUTION

WE HAVE ALL!

- SHOCKS AND STRUTS
- MOUNTING KITS
- PROTECTION KITS
- SPRINGS
- SUSPENSION PARTS
- GAS SPRINGS



No.1*

COVERAGE

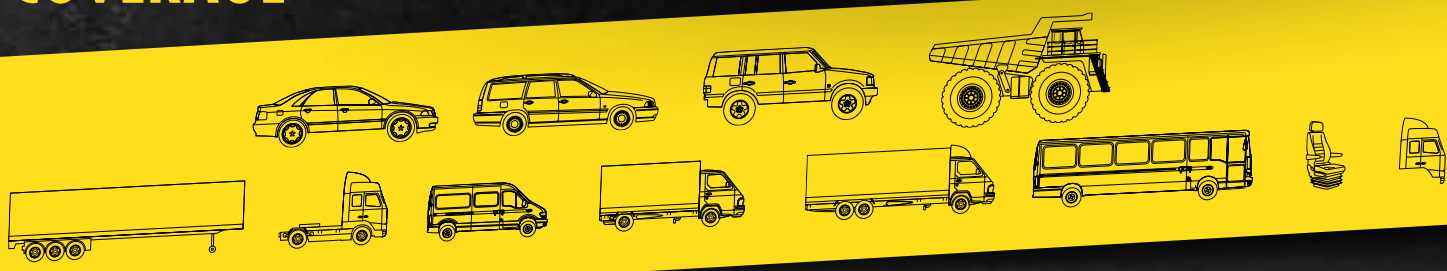

*Source TecAlliance 2016



**REPLACE YOUR OLD GAS SPRINGS
WITH MONROE® MAX-LIFT,
a new product from a name you trust!**



DON'T WAIT ANY LONGER!

HATCH - BONNET - BOOT - REAR WINDOW - FOLDING TABLE - INDUSTRIAL EXTENSIONS*

*Available via our search function listing more than 50 end-fittings & ball studs.





Max-Lift® is a sealed, gas filled pressure cylinder that exerts an outward force. This force acts like a spring to lift and hold open hatches, bonnets and boots. An exact replacement fit for most applications.

Features

- Superior rod finish - increased seal durability.
- High strength piston seal - superior sealing strength.
- High pressure gas filled - smooth action.
- Two years warranty.

MAX-LIFT	Typical Part N° Series
GAS SPRING	ML-

Monroe® quality and durability makes Max-Lift® the only choice.

Monroe® Max-Lift® gas charged lift supports are now available as exact replacement fits for most vehicles sold in Europe since 1980.

Max-Lift® is the market's premium replacement product. The highest quality, design and durability standards have been applied to their manufacture. And isn't that what your customers have a right to expect?

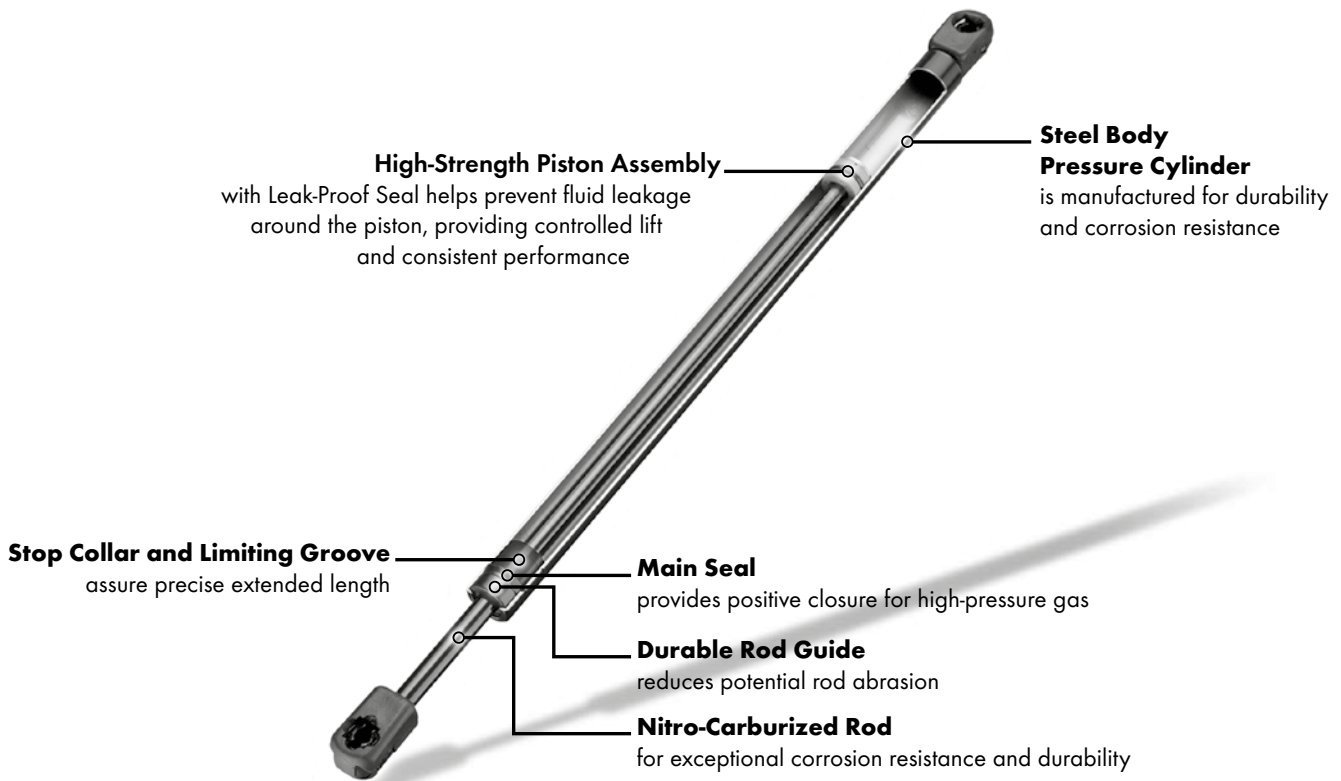

Max-Lift® installation guide

- Always replace both lift supports to ensure top performance and to prevent twisting caused by uneven loading.
- Gas charged lift supports typically store a gas charge of over 330 Newton and cannot be compressed by hand.
- Gas charge lift supports can be installed in minutes with no special tools required.
- Careful inspection of all hinges and connecting points should be made for wear and tear or stress fractures. These should be replaced or repaired before lift supports installation.

Installation Instructions:

- Before removing old lift supports, examine any fittings supplied to determine which components must be re-used.
- Have someone hold the hatch, bonnet, boot or rear window open while replacing the lift supports.
- The new lift support must be installed in the same position as the old one which was removed.
- Do not remove both lift supports at the same time. Replace one, then remove and replace the second one.
- Gas spring orientation ie. It is important that the gas spring be mounted with the tube up in the closed position as this ensures lubrication and smooth operation.

Important notes:

When ordering a gas spring, please consider the following:

- Overall length from centre to centre (Extended)
- Pressure
- Type of end fittings
- Year, Make and Model of vehicle

How to measure a Gas Spring:

- Overall length is measured with strut fully extended and taken between the centre's of the fixing studs.
- Stroke is measured between top of strut barrel and end of shaft fitting.



Standardized car description

HOW TO SELECT THE MONROE® GAS SPRING PRODUCT

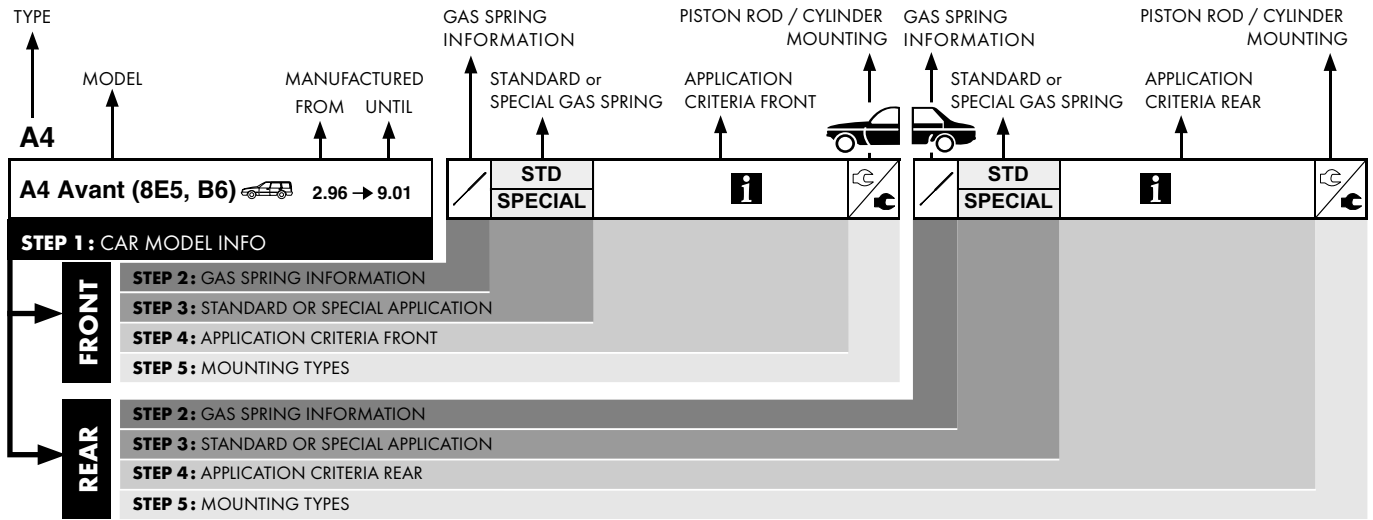

MODEL

(=)	Only used for
(-)	Without
(+)	With
	Berline, Sedan, Saloon, 2/4 doors
	Berline, Sedan, Saloon, 3/5 doors
	Fastback, Hatchback, Liftback
	Coupé, Hardtop
	Break, Estate, Station, Wagon
	Cabriolet, Convertible
	Car derived Van
	Multi Purpose Vehicle (MPV)
	Sport Utility or Activity Vehicle
	Off Road
	Pick up
	Delivery Van
	Minibus
	Cargo
	2-3-4-5 doors
OE n°	Original Equipment number
Ch. n°	Chassis number
	...onwards
	up to...
	Only for Cars sold in Sweden

STANDARD APPLICATIONS

	Gas spring
	Front
	Rear
	Spoiler
	Spoiler with additional stoplight
	Window wiper
	Loudspeaker
	Automatic closing
	Warning triangle
	Sunroof
	Left side
	Right side
	Lower
	Upper
	Folding top
	One piece tailgate
	Two piece tailgate
	Cars with fixed rear window
	Cars with opening rear window
	Tailgate without window
	Tailgate with window
	Hardtop

SPECIAL APPLICATIONS

	Opening rear window
	Folding table

PARTNUMBER

ML5001	New available partnumber
ML5853°	Part number in process

MOUNTING TYPES

	Piston rod mounting
	Cylinder mounting
	Reuse OE mounting(s)

Monroe® will only honour gas spring warranties when fitted in pairs.

TIPS FOR EASY READING: 1. Check for car make 2. Check for car model 3. Look at the year 4. Look at the type

Standardisierte Fahrzeugbeschreibung

DIE RICHTIGE MONROE® GASFEDER AUSWÄHLEN

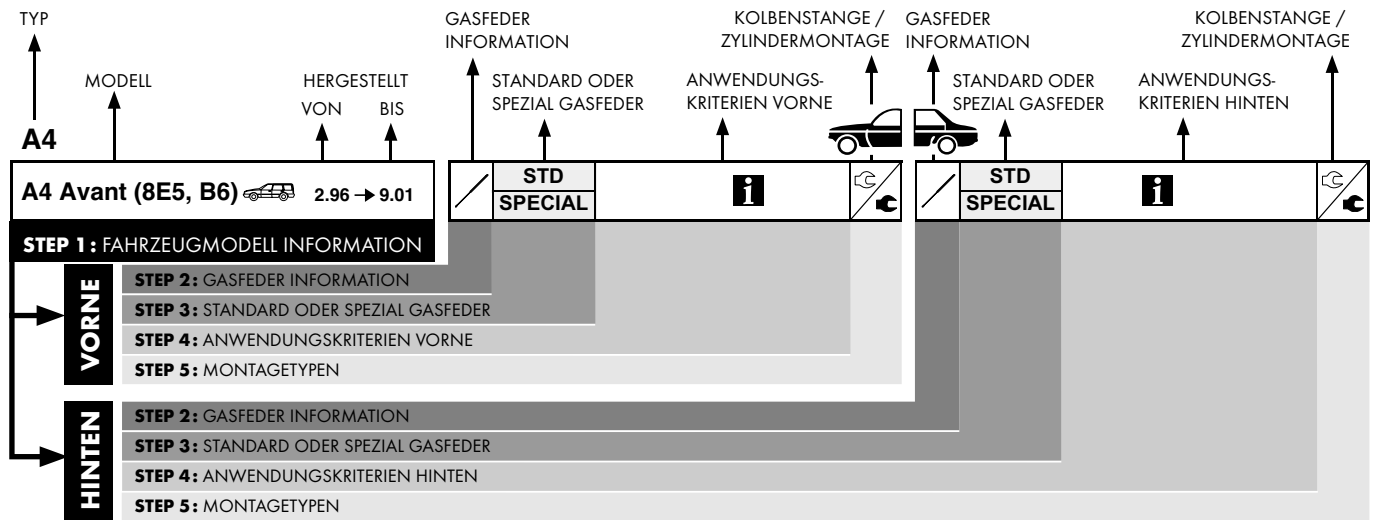

MODELL

(=)	Nur geeignet für
(-)	Ohne
(+)	Mit
	Limousine, 2/4 Türen
	Limousine, 3/5 Türen
	Schrägheck, Faltdach
	Coupé
	Kombi
	Cabriolet
	Lieferwagen
	Großraumlimousine
	SUV
	Off-Road
	Pick-up
	Transporter
	Minibus
	Fracht
	2-3-4-5 Türen
OE n°	Originalteilenummer
Ch. n°	Fahrgestell Nr.
	...von
	bis...
	Nur für in Schweden verkaufte Fahrzeuge

STANDARDANWENDUNGEN

	Gasfeder
	Vorne
	Hinten
	Spoiler
	Spoiler mit zusätzlichem Bremslicht
	Scheibenwischer
	Lautsprecher
	Automatische Heckklappe
	Warndreieck
	Schiebedach
	Linke Seite
	Rechte Seite
	Unten
	Oben
	Faltverdeck
	Einteilige Heckklappe
	Zweiteilige Heckklappe
	Autos mit fester Heckscheibe
	Autos mit zu öffnender Heckscheibe
	Heckklappe ohne Scheibe
	Heckklappe mit Scheibe
	Hardtop

SPEZIALANWENDUNGEN

	Zu öffnende Heckscheibe
	Klapptisch

TEILENUMMER

ML5001	Neue Teilenummer
ML5853°	Teilenummer in Vorbereitung

BEFESTIGUNGSARTEN

	Kolbenstangenmontage
	Zylindermontage
	Original Montageteile sind wiederzuverwenden

Monroe® gewährt Garantie nur für Gasfedern, die paarweise montiert sind.







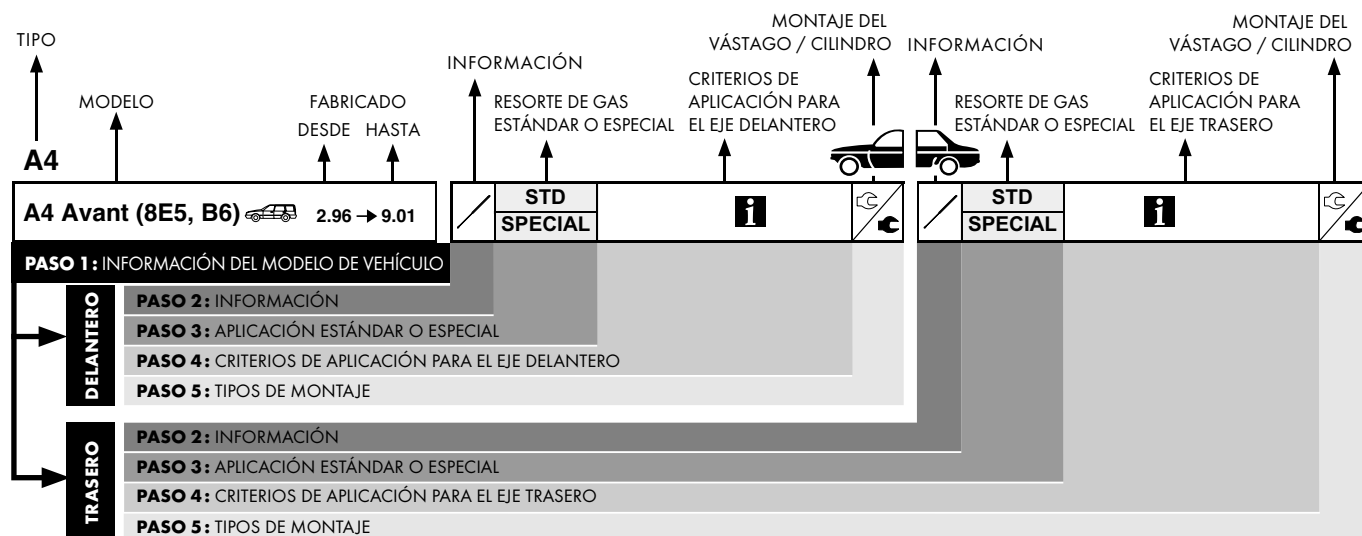











TIPPS: 1. Zuerst den Fahrzeughersteller ermitteln 2. Das Modell auswählen 3. Baujahr feststellen 4. Beachten Sie die Bauart des Fahrzeugs

Descripción estandarizada del vehículo





COMO SELECCIONAR LOS RESORTES DE GAS MONROE®





MODELO

(=)	Sólo utilizado para
(-)	Sin
(+)	Con
	Berlina, 2/4 puertas
	Berlina, 3/5 puertas
	Fastback, Hatchback, Liftback
	Coupé, Hardtop
	Familiar
	Cabrióle, descapotable
	Furgoneta
	Monovolumen
	De utilidad deportiva (SUV - Sport Utility) o de actividad deportiva (SAV - Sport Activity Vehicle)
	Todo terreno
	Pick Up
	Furgoneta
	Minibus
	Transporte de mercancías
	2-3-4-5 puertas
OE n°	N° de primer equipo
Ch. n°	Chassis N°
	Desde
	Hasta
	Sólo para vehículos vendidos en Suecia

APLICACIONES ESTÁNDARES

	Resorte de gas
	Delantero
	Trasero
	Alerón
	Alerón con luz de freno adicional
	Limpiaparabrisas
	Altavoz
	Cierre automático
	Triángulo de aviso
	Sunroof (techo corredizo)
	Lado izquierdo
	Lado derecho
	Inferior
	Superior
	Techo abatible
	Portón trasero de una pieza
	Portón trasero de dos piezas
	Coches con luneta trasera fija
	Coches con luneta trasera abatible
	Portón trasero sin luna
	Portón trasero con luna
	Techo duro



APLICACIONES ESPECIALES

	Luneta trasera abatible
	Techo abatible

REFERENCIA

ML5001	Nueva referencia disponible
ML5853°	Referencia en desarrollo

TIPOS DE MONTAJE

	Montaje del vástago
	Montaje del cilindro
	Reutilizar las fijaciones de origen

Monroe® solo cubre la garantía si los resortes de gas se sustituyen por pares.

INSTRUCCIONES DE FÁCIL COMPRESIÓN:

Compruebe el modelo del coche, el año de fabricación, el tipo y cc.

Description du véhicule

COMMENT BIEN CHOISIR LE VERIN A GAZ MONROE®

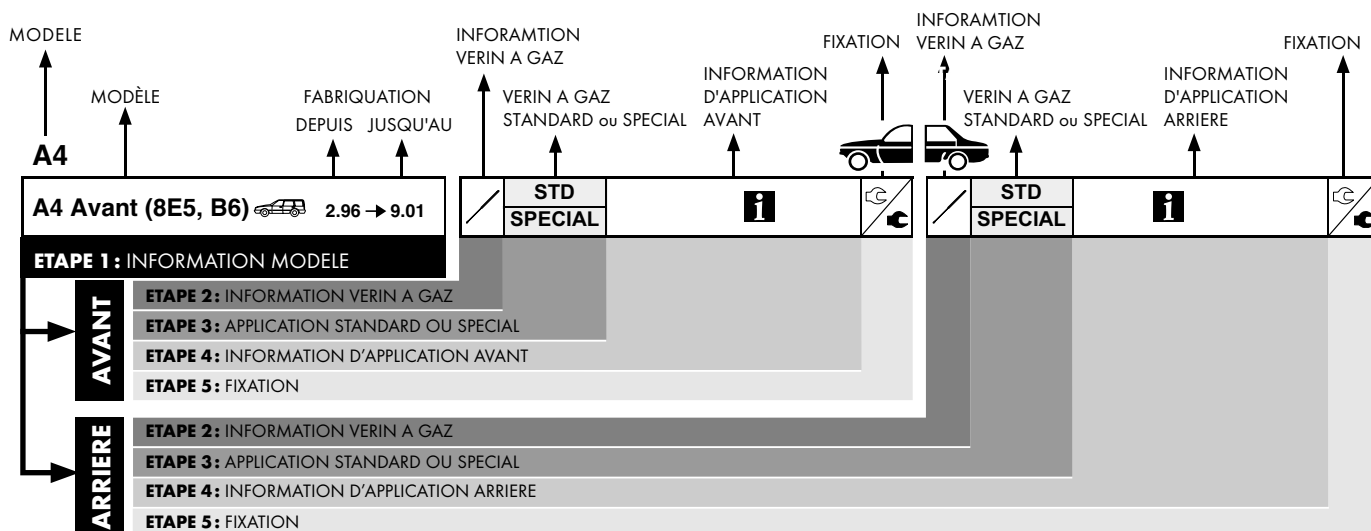

MODÈLE

(=)	Utilisé uniquement pour
(-)	Sans
(+)	Avec
	Berline, Sedan, Saloon, 2/4 portes
	Berline, Sedan, Saloon, 3/5 portes
	Fastback, Hatchback, Liftback
	Coupé
	Break, Estate, Station wagon
	Cabriolet, Convertible
	Camionnette/fourgonnette
	Monospace
	SUV or SAV (Sport Utility ou Sport Activity Vehicle)
	Off Road
	Pick-up
	Fourgon
	Minibus
	Transport de marchandises
	2-3-4-5 portes
OE n°	Référence OE
Ch. n°	N° de châssis
	... à partir de
	Jusqu'à ...
	Véhicules <u>vendus</u> en Suède uniquement

APPLICATIONS STANDARD

	Verin a gaz
	Avant
	Arriere
	Becquet
	Becquet avec feux stop additionnel
	Essuie glace
	Haut parleurs
	Fermeture automatique
	Triangle de sécurité
	Toit ouvrant
	Côté gauche
	Côté droit
	Inférieur
	Supérieur
	Toit repliable
	Hayon en 1 partie
	Hayon en 2 parties
	Vitre arrière fixe
	Vitre arrière ouvrante
	Hayon sans vitre
	Hayon avec vitre
	Hard-top

APPLICATIONS SPECIAL

	Vérin de vitre arrière
	Vérin de tablette de siège

REFERENCE

ML5001	Nouvelle référence disponible
ML5853°	Nouvelle référence en développement

TYPE DE FIXATION

	Fixation de la tige
	Fixation du cylindre
	Réutilisez les fixations d'origine

Monroe® assure la garantie si le vérin est remplacé par paire.

**CONSEILS DE LECTURE RAPIDE: 1. Vérifier la marque
2. Vérifier le modèle 3. Vérifier l'année 4. Vérifier la cylindrée**

Descrizione allestimento autovettura

COME SELEZIONARE LE MOLLE A GAS MONROE®

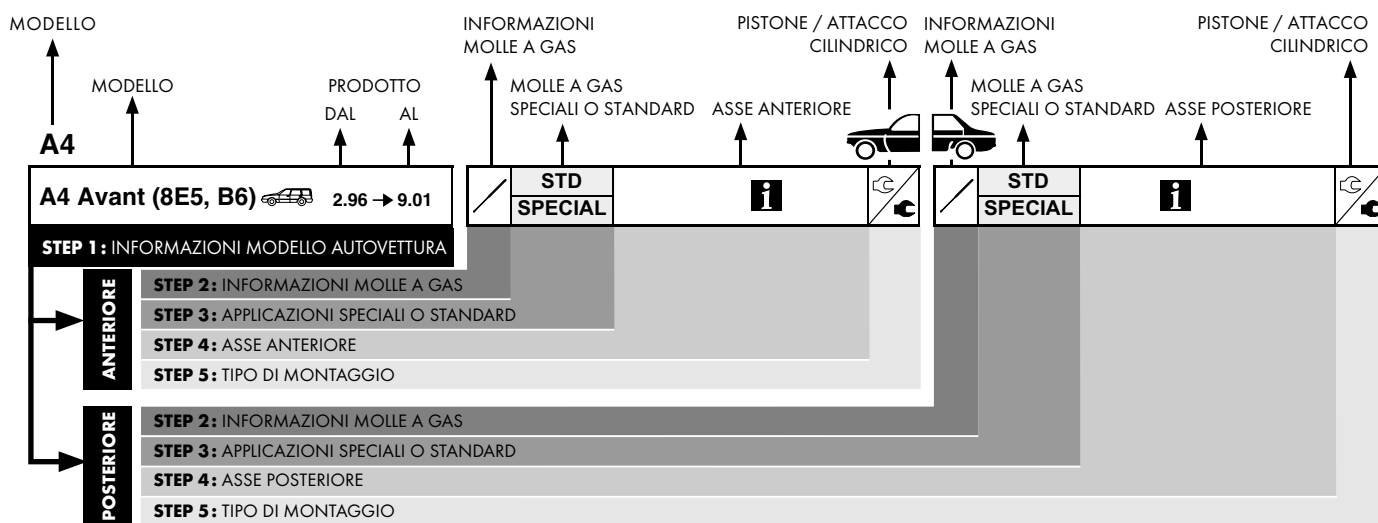

MODELLO

(=)	Utilizzato solo per
(-)	Senza
(+)	Con
	Berlina, 2/4 porte
	Berlina, 3/5 porte
	2 volumi
	Coupé
	Familiare, giardinetta
	Cabrio, convertibile
	Giardinetta
	Monovolume
	Sport Utility o Activity Vehicle
	Fuoristrada
	Furgone telonato
	Furgone
	Minibus
	Trasporto merci
	2-3-4-5 porte
OE n°	Codice OE
Ch. n°	Telaio n.
	A partire da
	Fino a
	Solo per auto <u>vendute</u> in Svezia

APPLICAZIONI STANDARD

	Molle a gas
	Anteriore
	Posteriore
	Spoiler
	Spoiler con luci di stop
	Tergicristallo
	Altoparlanti
	Chiusura automatica
	Triangolo sicurezza
	Tetto apribile
	Lato sinistro
	Lato destro
	Inferiore
	Superiore
	Cappotta pieghevole
	Portellone intero
	Portellone diviso
	Portellone con vetro fisso
	Portellone con vetro apribile
	Portellone senza vetro
	Portellone con vetro
	Cappotta rigida

APPLICAZIONI SPECIALI

	Vetro posteriore apribile
	Tavolino pieghevole

CODICE

ML5001	Nuovo modello disponibile
ML5853°	Modello in elaborazione

TIPO MONTAGGIO

	Montaggio Pistone
	Montaggio Cilindrico
	Riutilizzare pezzi di fissaggio originali

Monroe® terrà fede alla garanzia solamente se montati in coppia.

ISTRUZIONI:

Controllare il modello dell'auto, l'anno, la versione e la cilindrata.

Descrição do veículo

COMO ESCOLHER O SEU MAXLIFT MONROE®



TecAlliance

Certified Data Supplier

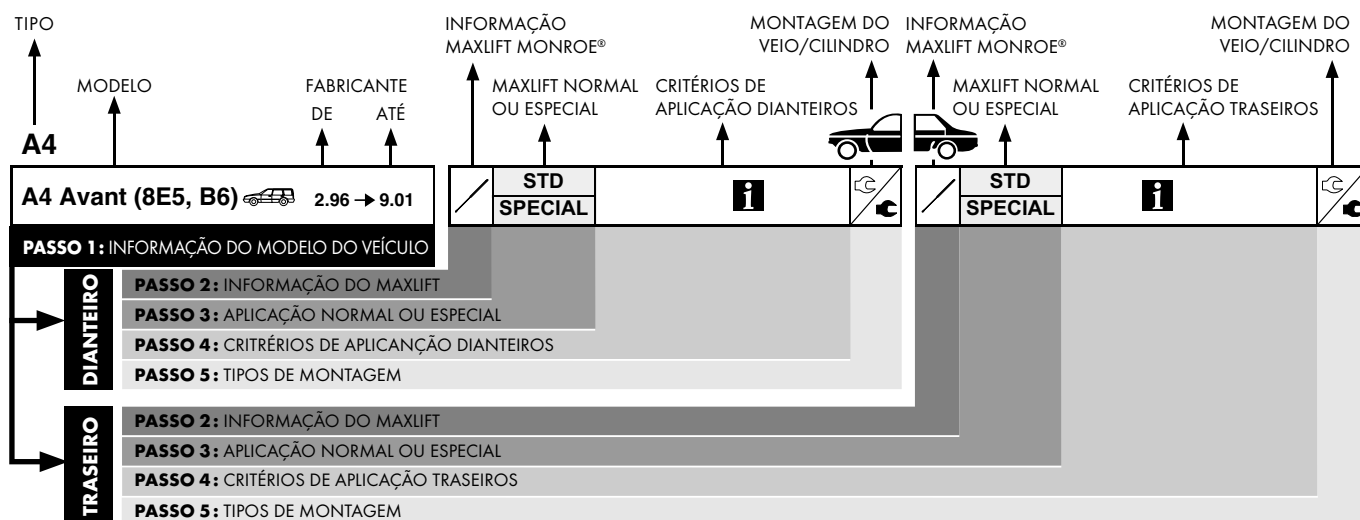

MODELO

(=)	Apenas usado para
(-)	Sem
(+)	Com
	Berline, Sedan, Saloon, 2/4 portas
	Berline, Sedan, Saloon, 3/5 portas
	Fastback, Hatchback, Liftback
	Coupé, Hardtop
	Break, Estate, Station, Wagon
	Cabriolet, Convertible
	Furgoneta
	Multi Purpose Vehicle (MPV)
	Sport Utility or Activity Vehicle (SUV/SAV)
	Todo-o-Terreno
	Pick-up
	Furgoneta
	Minibus
	Transporte de mercadorias
	2-3-4-5 Portas
OE n°	Número do Equipamento Original
Ch. n°	Chassis N°
	... a partir de
	Até...
	Apenas para carros vendidos na Suécia

APLICAÇÕES NORMAIS

	Amortecedor de Mala
	Dianteiro
	Traseiro
	Aileron
	Aileron com luz de travagem incorporada
	Limpa para-brisas
	Colunas
	Fecho automático
	Triângulo de segurança
	Teto de Abrir
	Lado Esquerdo
	Lado Direito
	Inferior
	Superior
	Descapotável
	Mala traseira de uma peça
	Mala traseira de duas peças
	Mala com vidro fixo
	Mala com vidro móvel
	Mala traseira sem vidro
	Mala traseira com vidro
	Hardtop

APLICAÇÕES ESPECIAIS

	Abertura vidro mala
	Mesa de abrir

REFERENCIA

ML5001	Nova referência disponível
ML5853°	Referência em desenvolvimento

TIPOS DE MONTAGEM

	Montagem do veio
	Montagem do cilindro
	Reutilizar as fixações originais

A Monroe® só poderá honrar a garantia quando a substituição é realizada aos pares.

SUGESTÕES PARA UMA FÁCIL LEITURA: 1. Verifique o fabricante do veículo 2. Verifique o modelo da viatura 3. Verifique o ano de fabrico 4. Verifique a cilindrada







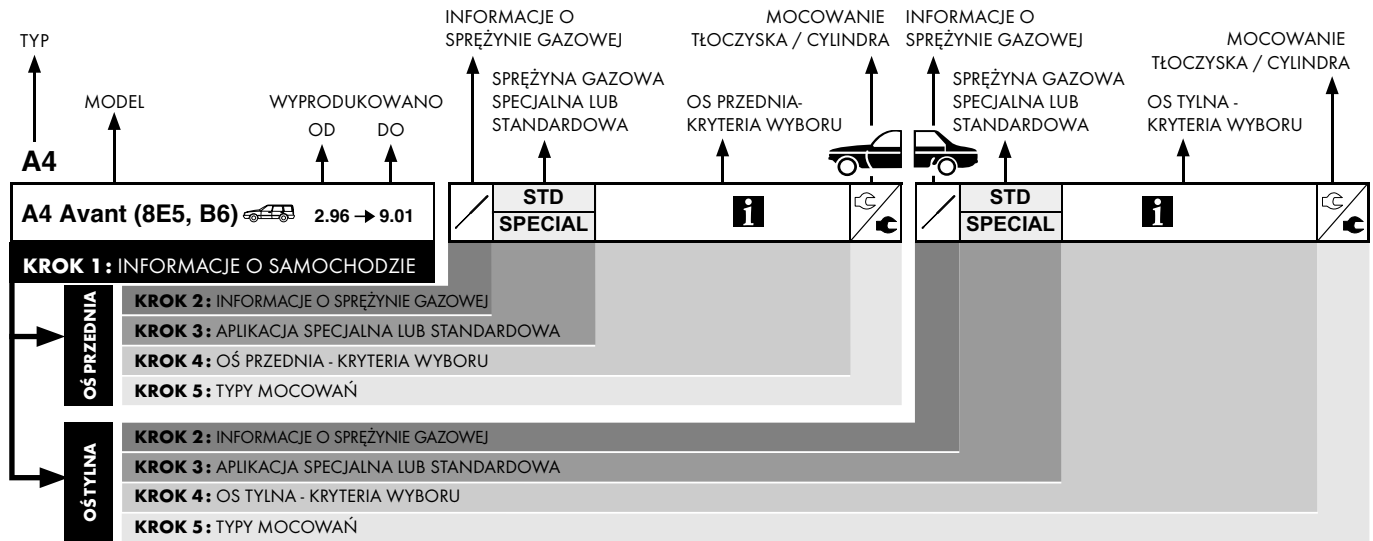













Standardowy opis samochodu

















JAK DOBRAĆ SPRĘŻYNĘ GAZOWĄ MONROE®





MODEL

(=)	Przeznaczone wyłącznie dla
(-)	Bez
(+)	Z
	Berline, Sedan, Saloon, 2/4 drzwi
	Hatchback, Liftback 3/5 drzwi
	Fastback, Hatchback, Liftback
	Coupé, Hardtop
	Kombi, Break, Estate, Station-Wagon
	Kabriolet, Convertible
	Samochód dostawczy
	MPV
	SUV, SAV
	Samochód terenowy
	Pick-up
	Furgon
	Mikrobus
	Samochód dostawczy
	2-3-4-5 drzwi
OE n°	Numer OE
Ch. n°	Numer nadwozia
	... począwszy od
	Aż do ...
	Tylko dla samochodów sprzedawanych w Szwecji

ZASTOSOWANIE STANDARDOWE

	Sprężyna gazowa
	Os przednia
	Os tylna
	Spojler
	Spojler z dodatkowym światłem stopu
	Wycieraczka
	Głośnik
	Automatyczne zamykanie
	Trójkąt ostrzegawczy
	Szyberdach
	Lewa strona
	Prawa strona
	Dół
	Góra
	Składany dach
	Jednoczęściowa kłapa tylna
	Dwuczęściowa kłapa tylna
	Samochody ze stałym tylnym oknem
	Samochody z otwieranym tylnym oknem
	Kłapa tylna bez okna
	Kłapa tylna z oknem
	Hardtop



ZASTOSOWANIA SPECJALNE

	Otwierane tylne okno
	Składany stolik

NUMER CZĘŚCI

ML5001	Nowe referencje
ML5853°	Referencja w przygotowaniu

TYPY MOCOWAŃ

	Mocowanie tłoczyska
	Mocowanie cylindra
	Montaż przy użyciu obecnych mocowań

Monroe® udziela gwarancji na produkty wyłącznie przy wymianie kompletu.

KROKI CZYTANIA KATALOGU: 1. Sprawdź producenta 2. Sprawdź model
3. Sprawdź rok produkcji 4. Sprawdź typ samochodu

Стандартизированное описание автомобиля

КАК ВЫБИРАТЬ ГАЗОВЫЕ ПРУЖИНЫ MONROE®

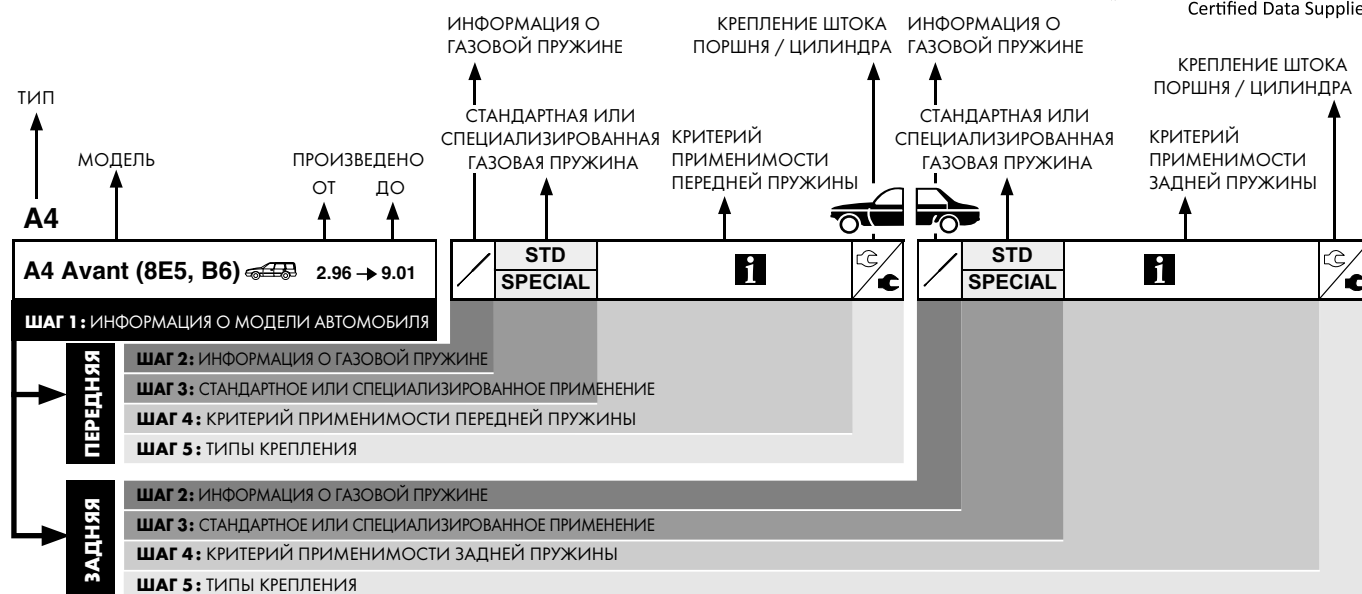

МОДЕЛЬ

(=)	Использовать только для
(-)	Без
(+)	С
	Седан 2/4 двери
	Седан 3/5 дверей
	Хэтчбэк, Лифтбэк
	Купе
	Универсал
	Кабриолет
	Фургон на базе седана
	Минивэн
	Кроссовер
	Внедорожник
	Пикап
	Фургон
	Микроавтобус
	Груз
	2-3-4-5 дверей
OE n°	Номер оригинальной детали
Ch. n°	Номер шасси
	От...
	До...
	Только для автомобилей, продаваемых в Швеции

СТАНДАРТНЫЕ ПРИМЕНЕНИЯ СПЕЦИАЛИЗИРОВАННЫЕ ПРИМЕНЕНИЯ

	Газовая пружина
	Передняя
	Задняя
	Спойлер
	Спойлер с дополнительным стоп-сигналом
	Стеклоочистители
	Динамик
	Автоматическое закрывание
	Аварийный треугольник
	Люк в крыше
	Левая сторона
	Правая сторона
	Нижний
	Верхний
	Откидной верх
	Одновдверный багажник
	Двудверный багажник
	Автомобили с фиксированным задним стеклом
	Автомобили с открывающимся задним стеклом
	Задняя дверца багажника без окна
	Задняя дверца багажника с окном
	Кузов типа "хардтоп"

	Открывающееся заднее стекло
	Складной столик

Артикул изделия

ML5001	Новая деталь, доступная для заказа
ML5853°	Деталь в процессе разработки

ТИПЫ КРЕПЛЕНИЙ

	Крепление штока поршня
	Крепление цилиндра
	Повторно используйте оригинальные крепления

Monroe® предоставляет гарантию на газовые пружины только, если они устанавливаются парами.

- СОВЕТЫ ДЛЯ ЛЕГКОГО ЧТЕНИЯ:**
1. Найдите название марки автомобиля
 2. Найдите модель автомобиля
 3. Выберите год выпуска автомобиля
 4. Выберите нужный тип детали

APPLICATION INFO

MAKE	MODEL	MONROE®	OE N°
AUDI	A3	2012	ML6284
AUDI	TT	2015	ML6349
BMW	2 Series	2014	ML6355
BMW	2 Series	2015	ML6355
BMW	5 Series	2010	ML6333
BMW	6 Series	2011	ML6333
CHEVROLET	Malibu	2012	ML6294
FIAT	500	2013	ML6281
FORD	Mondeo	2014	ML6358
KIA	Magentis	2001	ML6341
KIA	Magentis	2006	ML6342
KIA	Optima	2010	ML6343
MERCEDES	G-Series	1990	ML6309
MERCEDES	G-Series	1994	ML6309

MAKE	MODEL	MONROE®	OE N°
MERCEDES	GL-Series	2006	ML6312
MERCEDES	GL-Series	2006	ML6313
MERCEDES	GLK-Series	2009	ML6310
MERCEDES	GLK-Series	2009	ML6311
NISSAN	Murano	2008	ML6317
NISSAN	Patrol	1998	ML6269
PORSCHE	Cayenne	2010	ML6319
TOYOTA	Camry	2002	ML6323
TOYOTA	Camry	2006	ML6368
TOYOTA	Land Cruiser	1998	ML6324
TOYOTA	Land Cruiser	2003	ML6325
TOYOTA	Land Cruiser	2008	ML6345
VOLKSWAGEN	Passat	2015	ML6365

APPLICATION INFO

MAKE	MODEL	MONROE®	OE N°
AUDI	A3	2012	ML6290
AUDI	A3	2012	ML6291
AUDI	A3	2012	ML6292
AUDI	TT	2015	ML6346
AUDI	TT	2015	ML6347
BMW	2 Series	2014	ML6350
BMW	4 Series	2014	ML6348
BMW	4 Series	2014	ML6351
CHEVROLET	Cruze	2009	ML6295
CHEVROLET	Cruze	2009	ML6296
CITROEN	C1	2014	ML6353
CITROEN	C4	2014	ML6352
FIAT	500	2013	ML6276
FIAT	500	2013	ML6277
FIAT	500	2014	ML6344
FORD	Kuga	2013	ML6287
FORD	Kuga	2013	ML6299
FORD	Maverick	2001	ML6330
FORD	Maverick	2001	ML6366
FORD	Mondeo	2014	ML6354
FORD	Mondeo	2014	ML6356
FORD	Tourneo	2002	ML6297
FORD	Tourneo	2002	ML6298
FORD	Tourneo	2014	ML6297
FORD	Tourneo	2014	ML6298
JEEP	Grand Cherokee	2010	ML6300
JEEP	Grand Cherokee	2010	ML6301
JEEP	Grand Cherokee	2010	ML6302
KIA	Carens	2013	ML6367
KIA	Rio	2000	ML6303
LADA	Kalina	2004	ML6272
LADA	Kalina	2004	ML6273
LADA	Kalina	2004	ML6304
LADA	Priora	2007	ML6278
LADA	Priora	2007	ML6279
LANDROVER	Range Rover	2014	ML6305
LEXUS	RX	2003	ML6331
MAZDA	5	2010	ML6308

MAKE	MODEL	MONROE®	OE N°
MAZDA	626	1997	ML6337
MAZDA	626	1997	ML6338
MAZDA	Tribute	2001	ML6306
MAZDA	Tribute	2001	ML6307
MINI	Mini	2013	ML6314
MITSUBISHI	Outlander	2013	ML6315
NISSAN	Murano	2003	ML6316
NISSAN	Murano	2008	ML6318
NISSAN	Note	2013	ML6364
NISSAN	Pathfinder	2005	ML6285
NISSAN	Pulsar	2015	ML6340
NISSAN	Qashqai	2014	ML6363
OPEL	Astra	2010	ML6335
OPEL	Cascada	2013	ML6286
OPEL	Corsa	2015	ML6361
OPEL	Corsa	2015	ML6362
PEUGEOT	108	2014	ML6353
PEUGEOT	2008	2013	ML6360
PEUGEOT	407	2004	ML6280
RENAULT	Twingo	2014	ML6339
SEAT	Leon	2013	ML6320
SEAT	Leon	2013	ML6321
SKODA	Octavia	2004	ML6332
SKODA	Octavia	2013	ML6288
SKODA	Octavia	2013	ML6289
SKODA	Rapid	2013	ML6322
SUZUKI	SX4	2014	ML6336
TOYOTA	Auris	2013	ML6359
UAZ	Patriot	2005	ML6283
VAUXHALL	Astra	2010	ML6335
VAUXHALL	Cascada	2013	ML6286
VAUXHALL	Corsa	2015	ML6361
VAUXHALL	Corsa	2015	ML6362
VOLKSWAGEN	Amarok	2010	ML6328
VOLKSWAGEN	Amarok	2010	ML6329
VOLKSWAGEN	Beetle	2011	ML6326
VOLKSWAGEN	Golf	2013	ML6327
VOLKSWAGEN	Passat	2015	ML6357

MONROE® MAX-LIFT® CROSS REFERENCE LIST



STABILUS

STABILUS	MONROE®	STABILUS	MONROE®	STABILUS	MONROE®	STABILUS	MONROE®	STABILUS	MONROE®
1386BY	ML6269	79361	ML6290	200065	ML6322	947656	ML6342	573146	ML6357
364732	ML6272	389104	ML6291	200304	ML6322	948134	ML6342	451737	ML6358
370468	ML6273	515053	ML6291	763867	ML6326	919216	ML6343	537288	ML6359
263392	ML6277	093946	ML6292	630021	ML6327	869505	ML6344	387683	ML6360
370468	ML6278	878821	ML6300	273673	ML6328	782265	ML6346	142228	ML6361
369990	ML6279	014203	ML6303	779623	ML6329	855879	ML6346	292315	ML6361
33330	ML6280	361864	ML6304	112597	ML6330	853728	ML6347	141033	ML6362
515061	ML6281	662764	ML6305	3425VQ	ML6330	857547	ML6347	298768	ML6362
196943	ML6284	7835BD	ML6309	5394WU	ML6330	442407	ML6348	593932	ML6363
391494	ML6284	193359	ML6310	016943	ML6332	67405	ML6349	909658	ML6364
016533	ML6285	385040	ML6311	331280	ML6335	853489	ML6349	572907	ML6365
029111	ML6286	456737	ML6312	723700	ML6335	434042	ML6350	673274	ML6365
360428	ML6286	746659	ML6317	848473	ML6336	440017	ML6351	4227MV	ML6366
069793	ML6287	762194	ML6318	997620	ML6337	266505	ML6352	945033	ML6366
563092	ML6288	762672	ML6318	15058	ML6338	151314	ML6353	422817	ML6367
285866	ML6289	712941	ML6319	907985	ML6339	831028	ML6354		
584122	ML6289	630738	ML6320	925188	ML6340	826724	ML6355		
400574	ML6290	630499	ML6321	1493RQ	ML6341	905596	ML6356		

LESJOFORS

LESJOFORS	MONROE®	LESJOFORS	MONROE®	LESJOFORS	MONROE®	LESJOFORS	MONROE®	LESJOFORS	MONROE®
8104210	ML6269	8114208	ML6295	8056826	ML6313	8155425	ML6337	8195090	ML6357
8147004	ML6272	8114209	ML6296	8158706	ML6314	8155424	ML6338	8027503	ML6358
8147002	ML6273	8127585	ML6297	8159233	ML6315	8172972	ML6339	8192588	ML6359
8126158	ML6277	8127586	ML6298	8162060	ML6316	8044206	ML6342	8166768	ML6360
8147002	ML6278	8127583	ML6299	8162061	ML6318	8126160	ML6344	8163483	ML6361
8147003	ML6279	8142115	ML6300	8069707	ML6319	8092505	ML6345	8163482	ML6362
8166743	ML6280	8142116	ML6301	8182927	ML6321	8104262	ML6346	8162066	ML6363
8026104	ML6281	8142117	ML6302	8185722	ML6322	8104261	ML6347	8162065	ML6364
8004232	ML6284	8144214	ML6303	8185723	ML6322	8108437	ML6348	8095027	ML6365
8162052	ML6285	8175729	ML6305	8092500	ML6323	8004231	ML6349	8092501	ML6368
8163481	ML6286	8155462	ML6306	8092502	ML6324	8108436	ML6350		
8127584	ML6287	8155463	ML6307	8092503	ML6325	8108438	ML6351		
8185721	ML6289	8155464	ML6308	8195087	ML6326	8115670	ML6352		
8104264	ML6290	8056828	ML6310	8195088	ML6327	8166771	ML6353		
8104263	ML6291	8056829	ML6311	8185708	ML6332	8127587	ML6354		
8014201	ML6294	8056827	ML6312	8008424	ML6333	8127593	ML6356		

MONROE® MAX-LIFT® OE CROSS REFERENCE LIST

	OE N°:	Ref.		OE N°:	Ref.		OE N°:	Ref.
AUDI			FIAT	52029616	ML6344	FORD	BK21V406A10BB	ML6298
AUDI	8S0823359	ML6349	FIAT	52031518	ML6344	FORD	CV44S406A10AB	ML6287
AUDI	8S7827552A	ML6347	FORD			FORD	CV44S406A11AB	ML6299
AUDI	8S8827552A	ML6346	FORD	1786750	ML6298	FORD	DS73A406A10AF	ML6356
AUDI	8V0823359	ML6284	FORD	1786752	ML6297	FORD	DS73A406A10BE	ML6356
AUDI	8V082335903S	ML6284	FORD	1790926	ML6287	FORD	DS73A406A11AF	ML6356
AUDI	8V3827552	ML6291	FORD	1790927	ML6299	FORD	DS73A406A11BE	ML6356
AUDI	8V4827552	ML6290	FORD	1860856	ML6358	FORD	DS73F16C827AC	ML6358
AUDI	8V7827552A	ML6292	FORD	1891212	ML6356	FORD	DS73N406A10AD	ML6354
BMW			FORD	1891213	ML6356	FORD	DS73N406A11AD	ML6354
BMW	51237207188	ML6333	FORD	1891220	ML6354	JEEP		
BMW	51237300535	ML6355	FORD	1891221	ML6354	JEEP	55113632AA	ML6300
BMW	51247295205	ML6351	FORD	2018961	ML6358	JEEP	68079364AC	ML6301
BMW	51247295244	ML6348	FORD	2032183	ML6356	JEEP	68083884AA	ML6302
BMW	51247304556	ML6350	FORD	2032184	ML6356	JEEP	68083885AA	ML6302
CHEVROLET			FORD	4769673	ML6330	KIA		
CHEVROLET	25931219	ML6294	FORD	4770702	ML6330	KIA	OK34C62620D	ML6303
CHEVROLET	95146515	ML6296	FORD	4795798	ML6366	KIA	OK34C63620D	ML6303
CHEVROLET	95472696	ML6295	FORD	6L8478406A10AA	ML6330	KIA	811612G000	ML6342
FIAT			FORD	6L8478406A10AB	ML6330	KIA	811612T000	ML6343
FIAT	51883050	ML6277	FORD	6L8478406A11AA	ML6330	KIA	811613C500	ML6341
FIAT	51895435	ML6276	FORD	6L8478406A11AB	ML6330	KIA	811613C501	ML6341
FIAT	51923979	ML6281	FORD	7L847842104AA	ML6366	KIA	811613C510	ML6341
FIAT	51953757	ML6277	FORD	7L847842105AA	ML6366	KIA	81770A4000	ML6367
			FORD	BK21V406A10AB	ML6297	KIA	81770A4001	ML6367

MONROE® MAX-LIFT® OE CROSS REFERENCE LIST

	OE N°:	Ref.
KIA	81780A4000	ML6367
KIA	81780A4001	ML6367
LADA		
LADA	11188231015	ML6272
LADA	11198231010	ML6273
LADA	11198231010	ML6278
LADA	11198231015	ML6273
LADA	11198231015	ML6278
LADA	21118231010	ML6273
LADA	21118231010	ML6278
LADA	21118231015	ML6273
LADA	21118231015	ML6278
LADA	111908231015	ML6273
LADA	111908231015	ML6278
LADA	217208231015	ML6279
LADA	11180823101500	ML6272
LADA	11190823101500	ML6273
LADA	11190823101500	ML6278
LADA	21120823101000	ML6304
LADA	21120823101500	ML6304
LADA	21720823101500	ML6279
LANDROVER		
LANDROVER	DPLA406A10AA	ML6305
LANDROVER	DPLA406A10AB	ML6305
LANDROVER	LR044158	ML6305
LEXUS		
LEXUS	6895049065	ML6331
LEXUS	6896049065	ML6331
LEXUS	6896049205	ML6331
MAZDA		
MAZDA	4095842	ML6307
MAZDA	4551620	ML6306
MAZDA	4770700	ML6306
MAZDA	5T2478406A11BA	ML6306
MAZDA	C51362620A	ML6308
MAZDA	C51363620A	ML6308
MAZDA	EC0162620F	ML6306
MAZDA	EC01626B0C	ML6307
MAZDA	EC0163620D	ML6306
MAZDA	EC01636B0C	ML6307
MAZDA	EC01636B0D	ML6307
MAZDA	ECO162620D	ML6306
MAZDA	G14S63620	ML6337
MAZDA	G14S63620B	ML6337
MAZDA	G14S63620B	ML6338
MAZDA	G14S63620C	ML6337
MAZDA	G14S63620C	ML6338
MAZDA	G14S63620D	ML6337
MAZDA	G14S63620D	ML6338
MAZDA	G14S63620E	ML6337
MAZDA	G14S63620E	ML6338
MAZDA	YL847842105BC	ML6307
MAZDA	YL8Z78406A11BA	ML6306
MERCEDES		
MERCEDES	9808164	ML6309
MERCEDES	1649800364	ML6313
MERCEDES	1649800464	ML6312
MERCEDES	2049800564	ML6310
MERCEDES	2049800564	ML6311
MERCEDES	A0009808164	ML6309
MERCEDES	A2049800564	ML6310
MERCEDES	A2049800564	ML6311
MERCEDES	A2049801064	ML6311
MINI		
MINI	51249808987	ML6314
MITSUBISHI		
MITSUBISHI	5802A375	ML6315
MITSUBISHI	5802A376	ML6315

	OE N°:	Ref.
NISSAN		
NISSAN	4A5827552	ML6269
NISSAN	654701AA0A	ML6317
NISSAN	654701AA1A	ML6317
NISSAN	654711AA0A	ML6317
NISSAN	654711AA1A	ML6317
NISSAN	80450EB31A	ML6285
NISSAN	904501AA1A	ML6318
NISSAN	904503VA0A	ML6364
NISSAN	904503ZL1A	ML6340
NISSAN	904504EA1A	ML6363
NISSAN	90450CB80A	ML6316
NISSAN	90450EB31B	ML6285
NISSAN	904511AA1A	ML6318
NISSAN	904513VA0A	ML6364
NISSAN	904513ZL1A	ML6340
NISSAN	90451CB80A	ML6316
NISSAN	90451EB31A	ML6285
NISSAN	90451EB31B	ML6285
OPEL		
OPEL	176546	ML6286
OPEL	13370050	ML6286
OPEL	13379051	ML6335
OPEL	13428038	ML6361
OPEL	13428064	ML6362
PEUGEOT		
PEUGEOT		
PEUGEOT	9678317180	ML6360
PEUGEOT	9800805480	ML6352
PEUGEOT	9813913880	ML6352
PEUGEOT	689500H040	ML6353
PEUGEOT	8731L2	ML6280
PEUGEOT	B000877780	ML6353
PORSCHE		
PORSCHE	95851135900	ML6319
PORSCHE	7P5823359	ML6319
RENAULT		
RENAULT	904511881R	ML6339
SEAT		
SEAT	5F3827550A	ML6320
SEAT	5F9827550B	ML6321
SKODA		
SKODA	1Z5827550C	ML6332
SKODA	1Z5827550E	ML6332
SKODA	1Z5827550F	ML6332
SKODA	5E5827550	ML6289
SKODA	5E5827550A	ML6289
SKODA	5E9827550	ML6288
SKODA	5JJ827550A	ML6322
SKODA	5JJ827550B	ML6322
SKODA	5JJ827550C	ML6322
SKODA	5JJ827550D	ML6322
SUZUKI		
SUZUKI	8185061M00	ML6336
TOYOTA		
TOYOTA	5344069026	ML6324
TOYOTA	5344069075	ML6325
TOYOTA	5344069105	ML6345
TOYOTA	5344069135	ML6345
TOYOTA	5345006042	ML6368
TOYOTA	5345069026	ML6324
TOYOTA	5345069075	ML6325
TOYOTA	5345069105	ML6345
TOYOTA	5345069135	ML6345
TOYOTA	5345069145	ML6345
TOYOTA	6895002140	ML6359
TOYOTA	6896002130	ML6359
TOYOTA	53440AA011	ML6323

	OE N°:	Ref.
UAZ		
UAZ	12823101501	ML6283
VOLKSWAGEN		
VOLKSWAGEN	2H782755001	ML6329
VOLKSWAGEN	3G0823359	ML6365
VOLKSWAGEN	3G0823359A	ML6365
VOLKSWAGEN	3G9827550A	ML6357
VOLKSWAGEN	3G9827550B	ML6357
VOLKSWAGEN	5C3827550	ML6326
VOLKSWAGEN	5G9827550	ML6327
VOLKSWAGEN	8S0823359	ML6349
VOLKSWAGEN	8S7827552A	ML6347
VOLKSWAGEN	8S8827552A	ML6346
VOLKSWAGEN	C160419	ML6329
VOLKSWAGEN	STRT0017	ML6328

MONROE®



Start stocking Monroe® shocks and struts today.
Contact your representative for details.
www.monroe.com

MONROE®



ORIGINAL EQUIPMENT

THE DIFFERENCE IN TECHNOLOGY

As one of the world's foremost original equipment suppliers, Tenneco works in partnership with 40 leading vehicle manufacturers to develop and deliver innovative solutions that help maximize vehicle performance and driver/passenger safety and satisfaction.

The same commitment to quality and innovation seen in each of our OE products is designed and built into every replacement component carrying the Monroe® brand.

Tenneco is a global leader in Clean Air and Ride Performance with 89 manufacturing facilities and 14 engineering centers located in 24 countries on six continents.

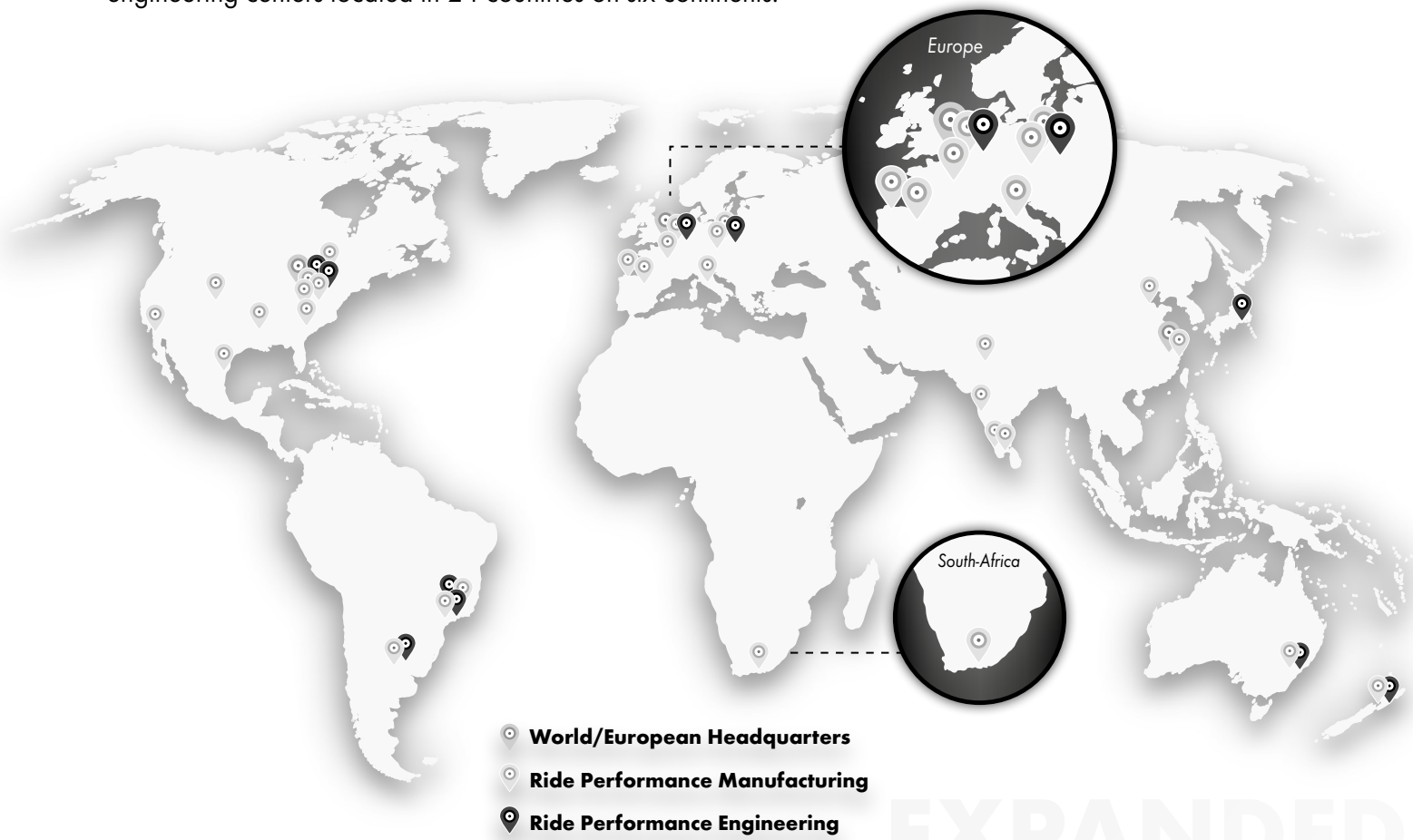

EXPANDED
COVERAGE

THE DIFFERENCE IN PERFORMANCE

Every Monroe® steering and suspension component is designed, manufactured and tested to meet the unique requirements of each vehicle application.

This comprehensive range of OE-quality replacement parts helps workshops earn the trust of today's most demanding consumers.

OE QUALITY

**ABARTH****500**

500 / 595 (312_)	8.08 →					ML5975		S1/S3
------------------	--------	--	--	--	--	---------------	--	-------

500C

500C / 595C (312_)	9.09 →					ML5975		S1/S3
--------------------	--------	--	--	--	--	---------------	--	-------

GRANDE PUNTO

GRANDE PUNTO (199_)	12.07 → 12.12					ML5775		S1/S1
---------------------	---------------	--	--	--	--	---------------	--	-------

PUNTO

PUNTO (199_)	5.08 →					ML5775		S1/S1
--------------	--------	--	--	--	--	---------------	--	-------

RITMO

RITMO (138A_)	11.81 → 12.87					ML5501 (+)		Y2/D
						ML5011		Y1/X1

ALFA ROMEO**33**

33 Sportwagon (907B_)	1.90 → 9.94					ML5597 (-)		U/X1
-----------------------	-------------	--	--	--	--	-------------------	--	------

145

145 (930_)	7.94 → 1.01					ML5335		S1/S1
------------	-------------	--	--	--	--	---------------	--	-------

146

146 (930_)	12.94 → 1.01					ML5271		U/U
						ML5272 (+)		U/U

147

147 (937_)	1.01 → 3.10		ML5696		P/U	ML5222		S1/U
------------	-------------	--	---------------	--	-----	---------------	--	------

155

155 (167_)	1.92 → 12.97		ML5608		N/N	ML5531		S1/T1
						ML5532 (+)		S1/T1

156

156 (932_)	9.97 → 9.05		ML5392		S1/S1	ML5215		S1/S1
156 Sportwagon (932_)	5.00 → 5.06		ML5392		S1/S1	ML5216 (+)		S1/S1
						ML5442		U/U

159

159 (939_)	9.05 → 11.11		ML5697		U/U	ML5698		S1/U
159 Sportwagon (939_)	3.06 → 11.11		ML5697		U/U	ML6149		G/G

ALFA ROMEO



164

164 (164_)	6.87 → 9.98
------------	-------------

ML5919		Y1/D
---------------	--	------

ML5273	(x1)	U/U
ML5274	(x2)	U/U

166

166 (936_)	9.98 → 6.07
------------	-------------

ML5414		S1/S1
---------------	--	-------

ML5419		S1/S1
---------------	--	-------

BRERA

BRERA (939_)	1.06 → 6.10
--------------	-------------

ML5697		U/U
---------------	--	-----

ML5920		U/U
---------------	--	-----

GIULIETTA

GIULIETTA (940_)	4.10 →
------------------	--------

ML6191		S1/S3
---------------	--	-------

ML6190		S1/S3
---------------	--	-------

GT

GT (937_)	11.03 → 9.10
-----------	--------------

ML5696		P/U
---------------	--	-----

ML5855		S1/S1
---------------	--	-------

GTV

GTV (916_)	6.95 → 10.05
------------	--------------

ML6138		U/U
---------------	--	-----

ML6137		U/U
---------------	--	-----

MITO

MITO (955_)	9.08 →
-------------	--------

--	--	--

ML5655		S1/U
---------------	--	------

SPIDER

SPIDER (916_)	9.94 → 4.05
---------------	-------------

ML6138		U/U
---------------	--	-----

ML5272		U/U
---------------	--	-----

SPIDER (939_)	3.06 → 6.10
---------------	-------------

--	--	--

ML5921		S1/S1
---------------	--	-------

AUDI

80

80 (89, 89Q, 8A, B3)	6.86 → 10.91
80 (8C, B4)	9.91 → 12.94
80 Avant (8C, B4)	9.91 → 1.96

ML5593		Y1/D
ML5333		Y1/D
ML5333		Y1/D

ML5417		S1/S1
ML5533	(+)	T1/T1
ML5376		U/S1
ML5104	(+)	U/S1
ML5437		S1/U

90

90 (89, 89Q, 8A, B3)	4.87 → 9.91
----------------------	-------------

ML5593		Y1/D
---------------	--	------

ML5417		S1/S1
ML5533	(+)	T1/T1

100

100 (44, 44Q, C3)	8.82 → 7.91
100 Avant (44, 44Q, C3)	8.82 → 11.90
100 (4A, C4)	12.90 → 6.94
100 Avant (4A, C4)	12.90 → 7.94

ML5420	Ch. n° 44F 115 151 →	Y1/D
ML5420	Ch. n° 44F 115 151 →	Y1/D
ML5385		U/X1
ML5385		U/X1

ML5428		S1/S1
ML5111		U/C1
ML5418		U/U

200

200 (44, 44Q)	8.83 → 12.91
200 Avant (44, 44Q)	9.83 → 12.91

ML5420	Ch. n° 44F 115 151 →	Y1/D
ML5420	Ch. n° 44F 115 151 →	Y1/D

ML5428		S1/S1

**A1**

A1 (8X1, 8XK)	5.10 →	ML6154		9/43	ML6153		7b/44
A1 Sportback (8XA, 8XF)	9.11 →	ML6154		9/43	ML6155		7b/44

A2

A2 (8Z0)	2.00 → 8.05				ML5370		U/P
----------	-------------	--	--	--	---------------	--	-----

A3

A3 (8L1)	9.96 → 5.03	ML5261		S1/U	ML5197	→ 8.00	S1/U
A3 (8P1)	5.03 → 8.12	ML5269		P/U	ML5198	8.00 →	S1/U
A3 Sportback (8PA)	9.04 → 3.13	ML5269		P/U	ML5459		S1/S1
A3 Convertible (8P7)	4.08 → 5.13	ML5269		P/U	ML5460	(+)	S1/S1
A3 (8V1, 8VK)	4.12 →	ML6284		P/C1	ML5749		U/P
A3 Sportback (8VA, 8VF)	9.12 →	ML6284		P/C1	ML5922		S1/S3
A3 Limousine (8VS, 8VM)	5.13 →	ML6284		P/C1	ML6291		U/C1
A3 Convertible (8V7, 8VE)	10.13 →	ML6284		P/C1	ML6290		U/K
					ML6292		S1/S3

A4

A4 (8D2, B5)	11.94 → 9.01	ML5679		L/L	ML5135		U/U
A4 Avant (8D5, B5)	11.94 → 9.01	ML5679		L/L	ML5197	→ 8.00	S1/U
A4 (8E2, B6)	11.00 → 12.04	ML5386		U/U	ML5223		U/U
A4 Avant (8E5, B6)	4.01 → 12.04	ML5386		U/U	ML5227		S1/S1
A4 Convertible (8H7, B6, 8HE, B7)	4.02 → 3.09	ML5269		P/U	ML5844		U/U
A4 (8EC, B7)	11.04 → 6.08	ML5386		U/U	ML5745		U/U
A4 Avant (8ED, B7)	11.04 → 6.08	ML5386		U/U	ML5747		T1/T1
A4 (8K2, B8)	11.07 → 12.15	ML5741		U/U	ML6225		S1/S3
A4 Avant (8K5, B8)	11.07 → 12.15	ML5741		U/U	ML5918		U/U
A4 Allroad (8KH, B8)	4.09 → 5.16	ML5741		U/U	ML5923	(+)	U/U

A5

A5 (8T3)	6.07 → 1.17	ML5741		U/U			
A5 Sportback (8TA)	9.09 → 1.17	ML5741		U/U	ML6102		U/P
A5 Convertible (8F7)	3.09 → 1.17	ML5741		U/U	ML6103		U/C1

A6

A6 (4A, C4)	6.94 → 10.97	ML5385		U/X1	ML5111		U/C1
A6 Avant (4A, C4)	6.94 → 12.97	ML5385		U/X1	ML5418		U/U
A6 (4B2, C5)	1.97 → 1.05	ML5678		U/L	ML5234	8.97 → 4.00	U/U
					ML5223	5.00 → 12.04	U/U

AUDI



MONROE	STD		↑ ↓	i	↺ ↻	STD		i	↑ ↓	↺ ↻
	SPECIAL					SPECIAL				
A6 Avant (4B5, C5) 12.97 → 1.05	ML5678					U/L	ML5240	OE nr: 4B9827552G	P/P	
A6 (4F2, C6) 5.04 → 3.11							ML5510	OE nr: 4B9827552D , OE nr: 4B9827552H	U/U	
A6 Avant (4F5, C6) 3.05 → 8.11							ML5511	OE nr: 4B9827552J	U/U	
A6 Allroad (4FH, C6) 5.06 → 8.11							ML5238	→ 4.00 OE nr: 4B9827552A	S1/P	
A6 (4G2, C7, 4GC) 11.10 →							ML5239	4.00 → OE nr: 4B9827552L , OE nr: 4B9827552M	P/U	
A6 Avant (4G5, C7, 4GD) 5.11 →							ML5744		U/U	
A6 Allroad (4GH, 4GJ) 1.12 →	ML6104	(+)	U/C1							
	ML5746		U/P							
	ML5746		U/P							
	ML6226	(-)	U/C1							
	ML6192	(+)	U/C1							
	ML6226	(-)	U/C1							
	ML6192	(+)	U/C1							

A7

A7 Sportback (4GA, 4GF) 10.10 →	ML6193		U/C1		
----------------------------------	--------	--	------	--	--

A8

A8 (4D2, 4D8) 3.94 → 9.02	ML5276		U/U	ML5275		U/U
A8 (4E_) 10.02 → 7.10	ML5924		U/C1	ML5926	 (+)	U/C1
A8 (4H_) 11.09 →	ML6106		U/C1	ML5925	 (+)	U/C1
				ML6105		S1/S1

ALLROAD

ALLROAD (4BH, C5) 5.00 → 8.05	ML5266		U/C1	ML5512		U/U
--------------------------------	--------	--	------	--------	--	-----

CABRIOLET

CABRIOLET (8G7, B4) 5.91 → 8.00	ML5333		Y1/D	ML5927	Ch. n° 8G-P-003 612 →	U/T1
----------------------------------	--------	--	------	--------	-----------------------	------

COUPE

COUPE (89, 8B) 10.88 → 12.96				ML5534		S1/U
-------------------------------	--	--	--	--------	--	------

Q3

Q3 (8U) 6.11 →	ML6156		13/44	ML6157		7b/44
-----------------	--------	--	-------	--------	--	-------

Q5

Q5 (8R) 11.08 →	ML5928		S1/S1	ML5856	(-)	U/U
				ML5857	(+)	P/P

Q7

Q7 (4L) 3.06 → 8.15	ML5739		U/P	ML5929	(-)	P/P
				ML5774	(+)	T1/P

TT

TT (8N3) 10.98 → 6.06	ML5135		U/U	ML5277		U/U
				ML5449	(+)	U/U



BMW



/	STD		i	
	SPECIAL			

/	STD		i	
	SPECIAL			

TT Roadster (8N9)	10.99 → 6.06
TT (8J3)	8.06 → 6.14
TT Roadster (8J9)	3.07 → 6.14
TT (FV3)	7.14 →
TT Roadster (FV9)	11.14 →

ML5135		U/U
ML5740		S1/U
ML5740		S1/U
ML6349 ⁰		U/C1
ML6349 ⁰		U/C1

ML6150		U/U
ML5753		U/U
ML5930		U/U
ML6346 ⁰		S1/C1
ML6347 ⁰		S1/S3

V8

V8 (44_, 4C_)	10.88 → 2.94
---------------	--------------

ML5420	Ch. n° 44F 115 151 →	Y1/D
--------	----------------------	------

--	--	--

AUSTIN

MAESTRO

MAESTRO (XC)	3.83 → 9.92
--------------	-------------

--	--	--

ML5362		U/U
--------	--	-----

METRO

METRO	10.80 → 4.90
-------	--------------

--	--	--

ML5041		U/U
--------	--	-----

AUTOBIANCHI

A 112

A 112	10.69 → 12.85
-------	---------------

--	--	--

ML5017		U/X2
--------	--	------

Y10

Y10	3.85 → 10.95
-----	--------------

--	--	--

ML5598		S1/S1
--------	--	-------

BMW

1

1 (E81)	9.06 → 9.12
1 (E87)	11.03 → 9.12
1 Coupe (E82)	10.07 → 10.13
1 Convertible (E88)	3.08 → 12.13
1 (F20)	11.10 →
1 (F21)	12.11 →

ML5563		S1/S1
ML5563		S1/S1
ML5563		S1/S1
ML5563		S1/S1
ML6158		7b/44
ML6158		7b/44

ML5691		S1/U
ML5691		S1/U
ML6141		S1/S1
ML6141		S1/S1
ML6159		9/43
ML6159		9/43

2

2 Coupe (F22, F87)	10.13 →
2 Convertible (F23)	11.14 →
2 Active Tourer (F45)	11.13 →
2 Gran Tourer (F46)	7.14 →

ML6160		7b/44
ML6160		7b/44
ML6355 ⁰		U/C1
ML6355 ⁰		U/C1

ML6350 ⁰		S1/S3

3

3 (E30)	9.82 → 1.92
3 Touring (E30)	7.87 → 6.94
3 Convertible (E30)	12.85 → 10.93
3 (E36)	9.90 → 2.98

ML5596		Y4/X1
ML5596		Y4/X1
ML5596		Y4/X1
ML5421		10/10

ML5450		U/U
ML5170		U/U
ML5260 (+)		U/U



/	STD			/
	SPECIAL			

/	STD			/
	SPECIAL			

3 Compact (E36)	3.94 → 8.00
3 Coupe (E36)	3.92 → 4.99
3 Convertible (E36)	3.93 → 4.99
3 Touring (E36)	1.95 → 10.99
3 (E46)	2.98 → 4.05
3 Compact (E46)	3.01 → 2.05
3 Coupe (E46)	4.99 → 7.06
3 Convertible (E46)	4.00 → 12.07
3 Touring (E46)	10.99 → 2.05
3 (E90)	1.05 → 12.11
3 Touring (E91)	12.04 → 6.12
3 Coupe (E92)	11.05 → 12.13
3 Convertible (E93)	5.06 → 12.13
3 (F30, F80)	10.11 →
3 Touring (F31)	10.11 →
3 Gran Turismo (F34)	3.13 →

ML5421		10/10
ML5422		10/10
ML5421		10/10
ML5421		10/10
ML5263		S1/S1
ML5263		S1/S1
ML5263		S1/S1
ML5263		S1/S1
ML5263		S1/S1
ML5263		S1/S1
ML5689		S1/P
ML5689		S1/P
ML5689		S1/P
ML5689		S1/P
ML6160		7b/44
ML6160		7b/44
ML6160		7b/44

ML5235		U/U
ML5237	(+)	U/U
ML5236	(+)	U/U
ML5170		U/U
ML5170		U/U
ML5436		S1/S1
ML5163		S1/S1
ML5671		U/U
ML5163		S1/S1
ML5670		S1/S1
ML5213		S1/S1
ML5694		S1/S1
ML5692		U/U
ML5658		S1/S1
ML5659		S1/S1
ML6161		7b/44
ML6194		U/C1

4

4 Coupe (F32, F82)	7.13 →
4 Convertible (F33, F83)	10.13 →
4 Gran Coupe (F36)	3.14 →

ML6160		7b/44
ML6160		7b/44
ML6160		7b/44

ML6351 ⁰		S1/S3
ML6348 ⁰		S1/S3
ML6351 ⁰		S1/S3

5

5 (E28)	5.81 → 12.87
5 (E34)	12.87 → 11.95
5 Touring (E34)	11.91 → 1.97
5 (E39)	11.95 → 6.03
5 Touring (E39)	1.97 → 5.04
5 (E60)	7.03 → 3.10
5 Touring (E61)	6.04 → 12.10
5 Gran Turismo (F07)	9.08 →
5 (F10)	1.09 →
5 Touring (F11)	11.09 →

ML5599		Y1/X1
ML5522		10/10
ML5522		10/10
ML5336		S1/S1
ML5336		S1/S1
ML5562		S1/S1
ML5562		S1/S1
ML6107		S1/S3
ML6333 ⁰	Active engine hood	U/M6
ML6333 ⁰	Active engine hood	U/M6

ML5444		10/10
ML5445	(+)	10/10
ML5521		T1/Q
ML5590		S1/12
ML5535		Y1/T1
ML6227		U/U

6

6 (E24)	10.75 → 4.89
6 (E63)	1.04 → 7.10
6 Convertible (E64)	4.04 → 7.10
6 Convertible (F12)	3.11 →
6 Coupe (F13)	11.10 →
6 Gran Coupe (F06)	9.11 →

ML5600		Y1/D
ML5932		S1/S1
ML5932		S1/S1
ML6333 ⁰	Active engine hood	U/M6
ML6333 ⁰	Active engine hood	U/M6
ML6333 ⁰	Active engine hood	U/M6

ML5695		S1/U
--------	--	------



CHEVROLET



7

7 (E23)	5.77 → 8.86
7 (E32)	9.86 → 9.94
7 (E38)	10.94 → 11.01
7 (E65, E66, E67)	11.01 → 12.09
7 (F01, F02, F03, F04)	2.08 → 12.15

ML5600	Y1/D
ML5566	10/10
ML5441	S1/S1
ML5565	P/S1
ML6142	U/C1

ML5934	10/10
ML5523	S1/12

X1

X1 (E84)	3.09 → 6.15
----------	-------------

ML6108	S1/S1
---------------	-------

ML6109	U/U
---------------	-----

X3

X3 (E83)	1.03 → 12.11
X3 (F25)	9.10 →

ML5769	U/S1
ML6163	7b/44

ML5693	P/S1
ML6162	7b/44

X5

X5 (E53)	5.00 → 12.06
X5 (E70)	2.06 → 6.13

ML5688	S1/S1
ML5936	P/U

ML5690	S1/S1
---------------	-------

X6

X6 (E71, E72)	6.07 → 6.14
---------------	-------------

ML5936	P/U
---------------	-----

--	--

Z3

Z3 (E36)	10.95 → 1.03
----------	--------------

--	--

ML5860	S1/S1
---------------	-------

Z4

Z4 (E85)	2.03 → 2.09
Z4 Coupe (E86)	3.06 → 1.09
Z4 ROADSTER (E89)	5.09 →

ML5938	S1/U
ML5938	S1/U
ML6111	S1/C1

ML5861	S1/S1
ML6110	S1/S3

CHEVROLET

AVEO

AVEO Hatchback (T250, T255)	1.08 →
AVEO Hatchback (T300)	3.11 →

ML5714	U/P
ML6229	S1/S3

CAPTIVA

CAPTIVA (C100, C140)	6.06 →
----------------------	--------

ML5939	U/U
---------------	-----

ML5940	S1/S1
---------------	-------

CRUZE

CRUZE Hatchback (J305)	6.11 →
CRUZE Station Wagon (J308)	8.12 →

ML6295	S1/P
ML6296	S1/S3

EPICA

EPICA (KL1_)	6.06 →
--------------	--------

--	--

ML6228	U/C1
---------------	------

KALOS

KALOS	3.05 →
-------	--------

--	--

ML5714	U/P
---------------	-----

CHEVROLET

CHEVROLET

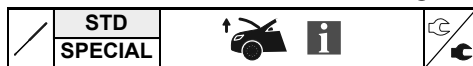

LACETTI

LACETTI (J200)	3.05 →					ML5794			T1/T1
----------------	--------	--	--	--	--	--------	--	--	-------

MALIBU

MALIBU (V300)	1.12 →		ML6294		P/C1				
---------------	--------	--	--------	--	------	--	--	--	--

MATIZ

MATIZ (M200, M250)	3.05 →					ML6140			S1/U
--------------------	--------	--	--	--	--	--------	--	--	------

NUBIRA

NUBIRA Estate	3.05 →					ML5941			S1/S1
---------------	--------	--	--	--	--	--------	--	--	-------

REZZO

REZZO	3.05 →					ML5446			T1/T1
-------	--------	--	--	--	--	--------	--	--	-------

SPARK

SPARK	9.00 → 12.04					ML5098			P/P
SPARK	5.05 →					ML5943			S1/S3
SPARK (M300)	3.10 →					ML5943			S1/S3

VECTRA

VECTRA	3.96 → 12.05		ML5085		U/U				
VECTRA	1.05 → 7.06		ML5085		U/U				

CHRYSLER

300 C

300 C (LX)	9.04 → 11.12		ML5945		P/U	ML5946	→ 12.07		U/C
300 C Touring (LX)	9.04 → 12.10		ML5945		P/U	ML6112	1.08 →		U/C
300 C	9.11 →					ML5944			P/P
						ML6112			U/C

GRAND VOYAGER

GRAND VOYAGER V (RT)	10.07 →					ML5947			P/P
----------------------	---------	--	--	--	--	--------	--	--	-----

PT CRUISER

PT CRUISER (PT_)	6.00 → 12.10					ML6113			Q/Q
------------------	--------------	--	--	--	--	--------	--	--	-----

VOYAGER

VOYAGER IV (RG, RS)	2.00 → 12.08					ML6195			U/U
---------------------	--------------	--	--	--	--	--------	--	--	-----

CITROËN

AX

AX (ZA_)	7.86 → 12.98					ML5607			S1/S1
----------	--------------	--	--	--	--	--------	--	--	-------

**BERLINGO**

BERLINGO (MF)	7.96 →
BERLINGO Box (M_)	7.96 →
BERLINGO (B9)	4.08 →
BERLINGO Box (B9)	4.08 →

ML5113		T1/T1
ML5113		T1/T1
ML5948		U/S1
ML5954	→ Org n° 118229	U/U
ML5956	Org n° 118230 →	S1/S3
ML5948		U/S1
ML5954	→ Org n° 118229	U/U
ML5956	Org n° 118230 →	S1/S3

BX

BX (XB_)	10.82 → 6.94
BX Break (XB_)	4.83 → 12.94

ML5603	→ 10.86	Y1/D
ML5605	10.86 →	S1/D
ML5452		U/U

C1

C1 (PM_, PN_)	6.05 →
C1 II	4.14 →

ML5687		U/U
ML6353 ⁰		S1/S3

C2

C2 (JM_)	9.03 →
----------	--------

--	--	--	--

ML5453		U/U
--------	--	-----

C3

C3 I (FC_)	2.02 →
C3 II	11.09 →
C3 Pluriel (HB_)	5.03 →
C3 Picasso	2.09 →

ML5151		U/U
ML6196		S1/S3
ML6248	↓	S1/S1
ML6249	↑	S1/S1
ML6114		S1/H1
ML5862		S1/S1

C4

C4 I (LC_)	11.04 → 7.11
C4 II (B7)	11.09 →
C4 Saloon	7.06 → 7.11
C4 Coupe (LA_)	11.04 → 7.11
C4 Picasso I (UD_)	2.07 → 8.13
C4 Grand Picasso I (UA_)	10.06 →
C4 CACTUS	9.14 →

ML5668		S1/U
ML6115		U/C1
ML5962		U/C1
ML5782		T1/T1
ML5824	(+)	S1/S1
ML5756	(+)	U/P
ML5755	(+)	U/P
ML5961		S1/S3
ML5783	(+)	U/P
ML5958	(+)	U/P
ML5959		S1/S1
ML6352 ⁰		S1/S3

C5

C5 I (DC_)	3.01 → 8.04
C5 I Break (DE_)	6.01 → 8.04
C5 II (RC_)	9.04 →

ML5461		S1/S1
ML5461		S1/S1
ML5461		S1/S1

ML5391		U/U
ML5536		U/Q
ML5963	(+)	S1/S1

CITROËN



MONROE	STD		↑	i	↺	STD		i	↑	↺
	SPECIAL					SPECIAL				
C5 II Break (RE_)	9.04	→								
C5 III (RD_)	2.08	→								
C5 III Break (TD_)	2.08	→								

C6

C6 (TD_)	9.05	→								
----------	------	---	--	--	--	--	--	--	--	--

C8

C8 (EA_, EB_)	7.02	→								
---------------	------	---	--	--	--	--	--	--	--	--

C-CROSSER

C-CROSSER (EP_)	2.07	→								
-----------------	------	---	--	--	--	--	--	--	--	--

CX

CX I (MA)	9.74	→	8.85							
CX I Break (MA)	9.75	→	8.85							
CX II	7.85	→	12.92							
CX II Break	7.85	→	12.92							

DS3

DS3	11.09	→	7.15							
-----	-------	---	------	--	--	--	--	--	--	--

DS4

DS4	4.11	→	7.15							
-----	------	---	------	--	--	--	--	--	--	--

EVASION

EVASION (22, U6)	6.94	→	7.02								

GS

GS	9.70	→	7.86							
GS Break	7.71	→	7.86							

JUMPY

JUMPY	1.07	→								
JUMPY Box	1.07	→								

NEMO

NEMO Estate	4.09	→								
-------------	------	---	--	--	--	--	--	--	--	--

SAXO

SAXO (S0, S1)	2.96	→	4.04							
---------------	------	---	------	--	--	--	--	--	--	--

VISA

VISA	9.78	→	3.91							
------	------	---	------	--	--	--	--	--	--	--



DACIA



XANTIA

XANTIA (X1)	3.93 → 1.98
XANTIA Break (X1)	6.95 → 1.98
XANTIA (X2)	2.99 → 4.03
XANTIA Break (X2)	1.98 → 4.03

ML5504		T1/T1
ML5503	(-)	T1/T1
ML5430		U/U
ML5504		T1/T1
ML5503	(-)	T1/T1
ML5430		U/U

XM

XM (Y3)	5.89 → 6.94
XM Break (Y3)	5.89 → 7.94
XM (Y4)	5.94 → 10.00
XM Break (Y4)	5.94 → 10.00

ML5457		U/U
ML5457		U/U
ML5457		U/U
ML5457		U/U

ML5504		T1/T1
ML5505		T1/T1
ML5504		T1/T1
ML5505		T1/T1

XSARA

XSARA (N1)	4.97 → 3.05
XSARA Break (N2)	10.97 → 8.05
XSARA Coupe (N0)	2.98 → 3.05
XSARA Box	9.00 → 3.05
XSARA PICASSO (N68)	12.99 →

ML5270	→ 9.00	U/U
ML5262	9.00 →	U/U
ML5270	→ 9.00	U/U
ML5262	9.00 →	U/U
ML5270	→ 9.00	U/U
ML5262	9.00 →	U/U
ML5262		U/U
ML5262	9.00 →	U/U

ML5129		S1/S1
ML5435		S1/S1
ML5129		S1/S1
ML5162		S1/S1

ZX

ZX (N2)	3.91 → 10.97
ZX Break (N2)	10.93 → 2.98

ML5255		U/U
ML5506		T1/T1

DACIA

DOKKER

DOKKER	11.12 →
DOKKER Express	12.12 →

ML6250		S1/S3
ML6250		S1/S3

DUSTER

DUSTER	4.10 →
DUSTER Box	4.11 →

ML6198		S1/S3
ML6198		S1/S3

ML5449		U/U
ML5449		U/U

LOGAN

LOGAN MCV (KS_)	2.07 →
LOGAN II	10.12 →
LOGAN MCV II	2.13 →

ML6199		S1/S3	
ML6199		S1/S3	

ML5864		U/U

SANDERO

SANDERO	6.08 →
SANDERO II	10.12 →

ML6199		S1/S3	

ML5864		U/U
ML6200		S1/S3

DACIA

DAEWOO

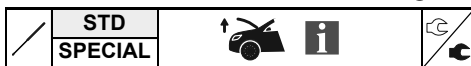

DAEWOO

KALOS

KALOS (KLAS)	9.02 →					ML5714		U/P
--------------	--------	--	--	--	--	---------------	--	-----

LACETTI

LACETTI Hatchback (KLAN)	2.04 →					ML5794		T1/T1
--------------------------	--------	--	--	--	--	---------------	--	-------

LANOS

LANOS (KLAT)	5.97 →					ML5087		U/C1
--------------	--------	--	--	--	--	---------------	--	------

MATIZ

MATIZ (KLYA)	9.98 →					ML5098		P/P
MATIZ Box (KLA4)	8.98 → 8.02					ML5098		P/P

NEXIA

NEXIA (KLETN)	2.95 → 8.97					ML5031		U/U
---------------	-------------	--	--	--	--	---------------	--	-----

NUBIRA

NUBIRA (KLAJ)	5.97 →					ML5507 (+) , 5		T1/T1
NUBIRA Saloon (KLAJ)	5.97 →					ML5095 (+)		U/U
NUBIRA Wagon (KLAJ)	5.97 →					ML5096		U/U
NUBIRA Saloon (KLAN)	7.03 →					ML5095 (+)		U/U
NUBIRA Wagon (KLAN)	7.03 →					ML5941		S1/S1

REXTON

REXTON (GAB_)	4.02 →					ML5334		U/U
		ML5355				ML5356		U/U

REZZO

REZZO (KLAU)	9.00 →					ML5513		T1/T1
--------------	--------	--	--	--	--	---------------	--	-------

TICO

TICO (KLY3)	2.95 → 12.00					ML5051		S1/E1
-------------	--------------	--	--	--	--	---------------	--	-------

DAIHATSU

SIRION

SIRION (M3_)	1.05 →					ML6084		T1/T1
--------------	--------	--	--	--	--	---------------	--	-------

DODGE

JOURNEY

JOURNEY	6.08 →					ML6230		U/P
---------	--------	--	--	--	--	---------------	--	-----



FIAT

MONROESTD
SPECIALSTD
SPECIAL**FIAT****126**

126 (126_) Special Design	9.87 → 6.96					ML5006		Y2/X2
---------------------------	-------------	--	--	--	--	---------------	--	-------

127

127 (127_)	6.71 → 12.86					ML5015	→ 3.77 3	Y1/X1
127 Panorama (127_)	1.77 → 12.86					ML5009	4.77 → 9.81 3	Y1/X1
						ML5034	9.81 → 3	Y1/X1
						ML5015	→ 3.77 3	Y1/X1

128

128 (128_)	3.69 → 12.84					ML5003		U/U
128 Familiare (128_)	10.69 → 10.82					ML5011		Y1/X1

131

131 Familiare/Panorama (131_)	3.75 → 12.84					ML5042		Y1/X1
----------------------------------	--------------	--	--	--	--	---------------	--	-------

132

132 (132_)	4.72 → 12.82		ML5030		Y1/X1	ML5018		Y1/X1
------------	--------------	--	---------------	--	-------	---------------	--	-------

147

147	10.76 → 12.95		ML5030		Y1/X1	ML5018		Y1/X1
-----	---------------	--	---------------	--	-------	---------------	--	-------

500

500 (312_)	10.07 →					ML5785		S1/S1
500 C (312_)	9.09 →					ML5975		S1/S3

500L

500L (199_)	9.12 →		ML6281		S1/S3	ML6277	(-) LIVING	U/C1
						ML6276	LIVING	U/13

500X

500X (334_)	9.14 →					ML6344⁰		U/C1
-------------	--------	--	--	--	--	---------------------------	--	------

BRAVA

BRAVA (182_)	10.95 → 12.02					ML5068		U/U
--------------	---------------	--	--	--	--	---------------	--	-----

BRAVO

BRAVO I (182_)	10.95 → 10.01					ML5069		U/U
BRAVO II (198_)	11.06 →					ML5784		U/U
BRAVO Van (198_)	3.08 → 6.14					ML5784		U/U

CINQUECENTO

CINQUECENTO (170_)	7.91 → 7.99					ML5081		U/C1
--------------------	-------------	--	--	--	--	---------------	--	------

FIAT

FIAT



COUPE

COUPE (175_)	11.93 → 8.00	ML5976	N/N		
--------------	--------------	---------------	-----	--	--

CROMA

CROMA (154_)	12.85 → 12.96			ML5043	Y1/X1
CROMA (194_)	6.05 →			ML5795	U/U

DOBLO

DOBLO MPV (119_, 223_)	3.01 →			ML5448	U/U
				ML5404 (+) Panoramic	U/U
DOBLO Cargo (223_)	3.01 →			ML5448	U/U
				ML5404 (+) Panoramic	U/U
DOBLO MPV (263_)	2.10 →			ML6201	U/K
DOBLO Box Body / Estate (263_)	2.10 →			ML6201	U/K

DUCATO

DUCATO Panorama (280_)	7.82 → 8.90			ML5074	F1/Y3
DUCATO Box (280_)	1.82 → 8.90			ML5074	F1/Y3
DUCATO Panorama (290_)	6.90 → 5.94			ML5074	F1/Y3
DUCATO Box (290_)	3.89 → 5.94			ML5074	F1/Y3

ELBA

ELBA (146_)	4.91 → 2.95			ML5064	U/U
-------------	-------------	--	--	---------------	-----

FIORINO

FIORINO Box Body / Estate (225_)	11.07 →			ML5968	U/U
----------------------------------	---------	--	--	---------------	-----

FREEMONT

FREEMONT (JC_, JF_)	8.11 →			ML6230	U/P
---------------------	--------	--	--	---------------	-----

GRANDE PUNTO

GRANDE PUNTO (199_)	10.05 →			ML5775	S1/S1
---------------------	---------	--	--	---------------	-------

IDEA

IDEA (350_)	12.03 →			ML5702	P/S1
-------------	---------	--	--	---------------	------

LINEA

LINEA (323_)	6.07 →			ML5975	S1/S3
--------------	--------	--	--	---------------	-------

MAREA

MAREA Weekend (185_)	9.96 → 2.03			ML5078	U/U
----------------------	-------------	--	--	---------------	-----

MULTIPLA

MULTIPLA (186_)	4.99 → 6.10	ML5389	S1/S1	ML5377	U/S1
-----------------	-------------	---------------	-------	---------------	------



FIAT

**PALIO**

PALIO (178BX)	4.96 →
PALIO Weekend (178_)	4.96 →

ML5462		S1/S1
ML5086		S1/S1

PANDA

PANDA (141_)	10.80 → 7.04
PANDA Van (141_)	1.86 → 2.04
PANDA (169_)	9.03 →
PANDA Van (169_)	3.04 →

ML5016	→ Vet n° 6314421, 5370347	Y1/X2
ML5039	Vet n° 6314422, 5370348 →	Y1/X2
ML5016	→ Vet n° 6314421, 5370347	Y1/X2
ML5039	Vet n° 6314422, 5370348 →	Y1/X2
ML5101		S1/S1
ML5101		S1/S1

PUNTO

PUNTO (176_)	9.93 → 9.99
PUNTO Convertible (176_)	4.94 → 6.00
PUNTO Van (176_)	4.96 → 2.00
PUNTO (188_)	9.99 → 3.12
PUNTO Van (188_)	2.00 → 10.09
PUNTO Van (199_)	2.06 →
PUNTO EVO (199_)	7.08 →
PUNTO (199_)	3.12 →

ML5079		U/U
ML5974		T1/T1
ML5973		S1/S1
ML5079		U/U
ML5164	3	U/U
ML5165	5	U/U
ML5164	3	U/U
ML5165	5	U/U
ML5775		S1/S1
ML5775		S1/S1
ML5775		S1/S1

QUBO

QUBO (225_)	2.08 →
-------------	--------

--	--	--	--

ML5968		U/U
--------	--	-----

REGATA

REGATA Weekend (138_)	1.84 → 12.90
-----------------------	--------------

--	--	--	--

ML5041		U/U
--------	--	-----

RITMO

RITMO Convertible (138_)	10.79 → 7.89
RITMO (138_)	1.78 → 12.87
RITMO II (138_)	10.82 → 12.88

ML5055		Y1/X1
ML5010		Y1/X1
ML5011		Y1/X1
ML5501	(+)	Y2/D

SCUDO

SCUDO Combinato (220_)	2.96 → 12.06
SCUDO Box (220_)	2.96 → 12.06
SCUDO (270_, 272_)	1.07 →
SCUDO Box (270_, 272_)	1.07 →

ML5950	(=)	U/U
ML5950	(=)	U/U
ML5950	(=)	U/U
ML5950	(=)	U/U

SEDICI

SEDICI (FY_)	6.06 → 10.14
--------------	--------------

--	--	--	--

ML5779		U/U
--------	--	-----

FIAT

FIAT

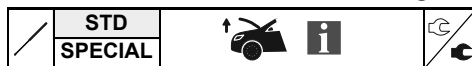

SEICENTO

SEICENTO / 600 (187_)	1.98 → 1.10
SEICENTO / 600 Van (287_)	1.98 → 1.10

ML5081		U/C1
ML5081		U/C1

STILO

STILO (192_)	10.01 → 11.06
STILO Multi Wagon (192_)	1.03 → 8.08

ML5038		U/U
ML5038		U/U

ML5280	3	U/U
ML5281	5	U/U
ML5443	(+)	U/U
ML5538	(+) , (+)	U/U
ML5537	(+)	U/U
ML5387		U/U

TALENTO

TALENTO Bus (290_)	3.89 → 3.94
TALENTO Box (290_)	3.89 → 3.94

ML5074		F1/Y3
ML5074		F1/Y3

TEMPRA

TEMPRA S.W. (159_)	3.90 → 8.96
--------------------	-------------

--	--	--	--

ML5282		U/U
--------	--	-----

TIPO

TIPO (160_)	7.87 → 10.95
-------------	--------------

--	--	--	--

ML5066	160.AE	U/U
ML5013	→ 3.93	U/U
ML5014	3.93 → 4.95	U/U

ULYSSE

ULYSSE (220_)	6.94 → 8.02
ULYSSE (179_)	8.02 → 6.11

ML5283		U/U
ML5458		U/U

UNO

UNO (146_)	1.83 → 6.06
UNO Box (146_)	2.88 → 7.96
UNO (146_)	3.02 → 4.10

ML5040	→ 9.89	U/U
ML5065	9.89 →	U/U
ML5040	→ 9.89	U/U
ML5065	9.89 →	U/U
ML5065		U/U

FORD

B-MAX

B-MAX (JK)	10.12 →
B-MAX Van	10.12 →

ML6202		U/C1
ML6202		U/C1

C-MAX

C-MAX (DM2)	2.07 → 9.10
C-MAX II (DXA/CB7, DXA/CEU)	12.10 →
C-MAX II Van	12.10 →

ML5288		U/U
ML6165		7b/44
ML6165		7b/44

FORD



STD		↑	i	↺
SPECIAL				

STD		i	↑	↺
SPECIAL				

FIESTA V (JH_, JD_)	11.01 → 6.08
FIESTA V Van	10.03 → 12.10
FIESTA VI	6.08 →
FIESTA VI Van	1.09 →
FIESTA Box (J5_, J3_)	2.96 → 8.03
FIESTA Box (JV_)	5.98 → 8.03

ML5205	3	U/U
ML5206	→ 11.02 5	U/U
ML5207	12.02 → 5	U/U
ML5205	3	U/U
ML5651		P/U
ML5651		P/U
ML5147		U/U
ML5147		U/U

FOCUS

FOCUS (DAW, DBW)	10.98 → 11.04
FOCUS Saloon (DFW)	2.99 → 3.05
FOCUS Estate (DNW)	2.99 → 1.05
FOCUS C-MAX	10.03 → 3.07
FOCUS II (DA_)	7.04 → 9.12
FOCUS II Saloon (DA_)	4.05 → 9.12
FOCUS II Estate (DA_)	7.04 → 9.12
FOCUS II Convertible	10.06 → 7.11
FOCUS III	7.10 →
FOCUS III Box Body / Hatchback Box Body / Hatchback	2.12 →
FOCUS III Box Body / Estate	2.12 →
FOCUS III Turnier	7.10 →

ML5415	(-)	U/U
ML5224	(+)	U/K
ML5466	→ 10.01	S1/S1
ML5467	10.01 →	S1/S1
ML5168	(-)	U/U
ML5169	(+)	U/U
ML5288		U/U
ML5416		U/U
ML5786		U/U
ML5664		U/U
ML5979		U/U
ML6166		7b/44
ML6166		7b/44
ML6167		7b/44
ML6167		7b/44

FUSION

FUSION (JU_)	8.02 → 12.12
--------------	--------------

--	--	--	--

ML5289		U/U
--------	--	-----

GALAXY

GALAXY (WGR)	3.95 → 5.06
GALAXY (WA6)	5.06 → 6.15

ML5127		U/U
ML5771		P/P

GRAND

GRAND C-MAX (DXA/CB7, DXA/CEU)	12.10 →
GRAND C-MAX Van	12.10 →

ML6168		13/44
ML6168		13/44

KA

KA (RB_)	9.96 → 11.08
KA (RU8)	10.08 →

ML5136		U/U
ML5977		S1/S1

KUGA

KUGA I	3.08 →
--------	--------

ML5654		U/U
ML5650		P/U



FORD

MONROE	STD					STD				
	SPECIAL					SPECIAL				
KUGA II (DM2) 3.13 →						ML6287		(-)		U/K
						ML6299		(-)		U/U
KUGA II Van 9.14 →						ML6287		(-)		U/K
						ML6299		(-)		U/U

MAVERICK

MAVERICK 2.01 →						ML6330⁰				U/15
						ML6366⁰				P/C1

MONDEO

MONDEO I (GBP) 2.93 → 8.96						ML5126				S1/U
MONDEO I Saloon (GBP) 2.93 → 8.96						ML5290				U/U
MONDEO I Estate (BNP) 1.93 → 8.96						ML5431	(+)			U/U
MONDEO II (BAP) 8.96 → 9.00						ML5332				U/U
MONDEO II Saloon (BFP) 8.96 → 9.00						ML5176				S1/U
MONDEO II Estate (BNP) 8.96 → 9.00						ML5290				U/U
						ML5332				U/U
MONDEO III (B5Y) 10.00 → 3.07		ML5330				ML5233	(+)			U/U
						ML5232	(+)			U/U
						ML5231	→ 12.01 (-)			U/U
						ML5373	1.02 → (-)			U/U
MONDEO III Saloon (B4Y) 10.00 → 3.07		ML5330				ML5502				S1/S1
MONDEO III Estate (BWY) 10.00 → 3.07		ML5330				ML5374				U/U
MONDEO IV (BA7) 3.07 →						ML5797				T1/T1
MONDEO IV Saloon (BA7) 3.07 → 9.14						ML5704				T1/T1
MONDEO IV Turnier (BA7) 3.07 → 9.14						ML5772				T1/P
MONDEO V Saloon 9.14 →										
MONDEO V Hatchback 9.14 →						ML6358⁰				P/C1
MONDEO V Hatchback 9.14 →						ML6358⁰				P/C1
MONDEO V Hatchback 9.14 →						ML6356⁰	(-)			U/U
MONDEO V Turnier 9.14 →						ML6354⁰	(-)			U/U

ORION

ORION I (AFD) 7.83 → 3.86						ML5611				Y1/D
ORION II (AFF) 12.85 → 7.90						ML5611				Y1/D

PUMA

PUMA (EC_) 3.97 → 6.02						ML5399				U/U
-------------------------	--	--	--	--	--	---------------	--	--	--	-----

SCORPIO

SCORPIO I (GAE, GGE) 4.85 → 9.94						ML5612	(+) . (+)			U/U
						ML5291	(+)			U/U
						ML5110				U/U
SCORPIO I Estate (GGE) 5.88 → 9.94						ML5388				U/U

FORD

FORD



/	STD	↑	↺
	SPECIAL		

/	STD		↻
	SPECIAL		

SCORPIO II (GFR, GGR) 10.94 → 8.98
SCORPIO II Estate (GNR, GGR) 10.94 → 8.98

ML5292	4	U/U
ML5292	4	U/U

ML5388	U/U
--------	-----

SIERRA

SIERRA Hatchback (GBC) 8.82 → 2.87
SIERRA Hatchback (GBC, GBG) 1.87 → 3.93
SIERRA Estate (BNG) 1.87 → 2.93

ML5080	(-)	U/U
ML5253	(+)	U/U
ML5539	(+)	U/U
ML5080	(-)	U/U
ML5253	(+)	U/U
ML5539	(+)	U/U
ML5293	(-)	U/U
ML5294	(+)	U/U

S-MAX

S-MAX (WA6) 5.06 → 12.14

--	--	--

ML5770	P/P
--------	-----

STREETKA

STREET KA (RL2) 5.03 → 7.05

--	--	--

ML5978	S1/S1
--------	-------

TOURNEO

TOURNEO CONNECT 6.02 → 12.13
TOURNEO CONNECT / GRAND TOURNEO CONNECT Kombi 9.13 →
TOURNEO COURIER Kombi 2.14 →

ML6297	(=)	U/U
ML6298	(=)	U/U
ML6297	(=)	U/U
ML6298	(=)	U/U
ML6297	(=)	U/U
ML6298	(=)	U/U

TRANSIT

TRANSIT Bus (T_) 10.85 → 9.92
TRANSIT Box (T_) 9.85 → 9.92
TRANSIT Bus (E_) 1.91 → 9.94
TRANSIT Bus (FD_, FB_, FS_, FZ_, FC_) 1.00 → 5.06
TRANSIT Box (FA_) 1.00 → 5.06
TRANSIT Bus 4.06 → 8.14
TRANSIT Box 4.06 → 8.14

ML5429	(-)	U/U
ML5076	(+)	U/U
ML5429	(-)	U/U
ML5429	(-)	U/U
ML5076	(+)	U/U
ML5514		U/U
ML5514		U/U
ML5514		U/U
ML5514		U/U

TRANSIT CONNECT

TRANSIT CONNECT (P65_, P70_, P80_) 6.02 → 12.13
--

--	--	--

ML5295	U/U
--------	-----

GAZ

SOBOL

SOBOL (2217) Bus 1.97 →
SOBOL (2752) Box 1.97 →

ML6231	U/U
ML6231	U/U



HONDA

ACCORD

ACCORD VI Hatchback (CH, CL)	12.99 → 12.02				ML5787		T1/T1
ACCORD VII Tourer (CM, CN)	4.03 → 5.08				ML5982		1/1
ACCORD VIII Estate (CW)	7.08 →				ML5983 (-)		U/P
					ML5984 (+)		U/P

CIVIC

CIVIC IV Hatchback (EC, ED, EE)	9.87 → 9.91				ML5567	3	S1/S1
CIVIC V Hatchback (EG)	10.91 → 11.95				ML5568	3	S1/S1
CIVIC VI Hatchback (EJ, EK)	10.95 → 2.01				ML5405	5	U/U
CIVIC VI Fastback (MA, MB)	9.94 → 2.01				ML5214	5	S1/S1
CIVIC VI Aerodeck (MB, MC)	4.98 → 2.01				ML5214	5	S1/S1
CIVIC VII Hatchback (EU, EP, EV)	1.00 → 9.05				ML5122	5	U/U
					ML5396	3	U/U
					ML5371	5	U/U
					ML5615 ¹	5 , D14Z5,D16V2/W7,D17A2	U/P
CIVIC VIII Hatchback (FN, FK)	9.05 →				ML5836		T1/T1

CONCERTO

CONCERTO (HW, MA)	8.89 → 3.95				ML5508		T1/T1
					ML5192 (+)		U/U

CR-V

CR-V I (RD)	10.95 → 2.02				ML5447		T1/T1
CR-V II (RD_)	9.01 → 9.06				ML5910		U/S1
CR-V III (RE)	9.06 →				ML5866		U/P

FR-V

FR-V (BE)	8.04 →				ML5985		T1/T1
-----------	--------	--	--	--	--------	--	-------

JAZZ

JAZZ II (GD_, GE3)	3.02 → 7.08				ML5911		T1/T1
--------------------	-------------	--	--	--	--------	--	-------

HYUNDAI

ACCENT

ACCENT I (X-3)	10.94 → 1.00				ML5157		U/U
ACCENT II (LC)	1.00 → 11.05	ML6144		S1/C1	ML5986		S1/C1

ATOS

ATOS (MX)	6.03 → 12.10				ML5987		U/S1
ATOS PRIME (MX)	8.99 →				ML5987		U/S1

HYUNDAI

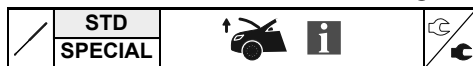

COUPE

COUPE (RD)	8.96 → 4.02
COUPE (GK)	8.01 → 8.09

ML5814		U/U
ML5814		U/U

ML5379		U/S1
ML5379 (+)		U/S1
ML5378		U/S1

ELANTRA

ELANTRA (XD)	6.00 → 7.06
--------------	-------------

--	--	--

ML5569		S1/S1
ML5380 (+)		U/S1

GETZ

GETZ (TB)	9.02 → 12.10
-----------	--------------

--	--	--

ML5759		T1/T1
---------------	--	-------

H-1

H-1 Cargo (TQ)	2.08 →
H-1 Travel (TQ)	2.08 →

--	--	--

ML5989		U/K
ML5989		U/K

i10

i10 (PA)	12.07 → 12.13
----------	---------------

--	--	--

ML5867		U/U
---------------	--	-----

i20

i20 (PB, PBT)	8.08 → 12.15
---------------	--------------

--	--	--

ML5868		U/P
---------------	--	-----

i30

i30 (FD)	10.07 → 11.11
i30 CW (FD)	10.07 → 6.12
i30 (GD)	11.11 →

--	--	--

ML5869		U/P
ML5990		U/U
ML6232		U/C1

i40

i40 (VF)	3.12 →
----------	--------

ML6255		U/C1
---------------	--	------

--	--	--

ix20

ix20 (JC)	11.10 →
-----------	---------

--	--	--

ML6203		U/C1
---------------	--	------

ix35

ix35 (LM, EL, ELH)	8.09 →
--------------------	--------

--	--	--

ML5380		U/S1
---------------	--	------

ix55

ix55	1.07 →
------	--------

ML5992		P/U
---------------	--	-----

ML5991		U/U
---------------	--	-----

LANTRA

LANTRA II Wagon (J-2)	2.96 → 10.00
-----------------------	--------------

--	--	--

ML5296		U/U
---------------	--	-----

MATRIX

MATRIX (FC)	6.01 → 8.10
-------------	-------------

--	--	--

ML5616		S1/U
---------------	--	------

SANTA FÉ

SANTA FÉ I (SM)	11.00 → 3.06
SANTA FÉ II (CM)	3.06 → 12.12

ML5382		U/S1
ML5660		P/U

ML5381		U/S1
ML5297		U/U
ML6169		7b/13



JEEP

**SONATA**

SONATA IV (EF)	3.98 → 11.04	ML5570	S1/S1	ML5154	U/U
SONATA V (NF)	1.05 → 12.10	ML5758	P/U	ML5761	U/U
SONATA VI (YF)	1.09 → 11.10	ML5758	P/U		

TRAJET

TRAJET (FO)	3.00 → 7.08			ML5816	T1/T1
-------------	-------------	--	--	--------	-------

TUCSON

TUCSON (JM)	8.04 → 3.10			ML5760	P/U
				ML5762	P/U

XG

XG (XG)	12.98 → 12.05			ML5994	U/C1
---------	---------------	--	--	--------	------

INNOCENTI**ELBA**

ELBA (146)	8.91 → 12.96			ML5064	U/U
------------	--------------	--	--	--------	-----

MINI

MINI Special Design	5.74 → 2.82			ML5056	Y1/X1
---------------------	-------------	--	--	--------	-------

JAGUAR**S-TYPE**

S-TYPE (CCX_)	1.99 → 10.07	ML5995	U/P		
---------------	--------------	--------	-----	--	--

XF

XF (CC9_)	3.08 → 4.15	ML6205	U/C1	ML6204	S1/S3
XF SPORTBRAKE (CC9_)	9.12 → 4.14	ML6205	U/C1		
XF (JB_)	5.15 →	ML6205	U/C1	ML6204	S1/S3

X-TYPE

X-TYPE (CF1_)	6.01 → 11.09	ML5832	U/P	ML5996	U/C1
X-TYPE Estate (CF1_)	11.03 → 12.09	ML5832	U/P	ML6233	U/C1

JEEP**CHEROKEE**

CHEROKEE	10.80 → 9.86			ML5591	U/Q
CHEROKEE (XJ)	10.84 → 9.01			ML5591	U/Q

COMPASS

COMPASS (MK49)	8.06 →			ML6117 (-)	U/C1
				ML6116 (+)	U/C1

JEEP

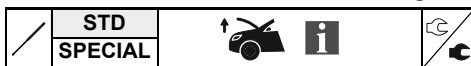

GRAND CHEROKEE

GRAND CHEROKEE II (WJ, WG)	4.99 → 9.05
GRAND CHEROKEE III (WH, WK)	6.05 → 12.10
GRAND CHEROKEE IV (WK, WK2)	11.10 →

ML6000		U/U
ML5999		U/U

ML6001		Q/Q
ML5997		P/S1
ML5998		C/U
ML6300	(-)	U/U
ML6301	(+)	U/U
ML6302		S1/S3

KIA

CARENS

CARENS II (FJ)	7.02 →
CARENS III (UN)	9.06 →
CARENS IV	3.13 →

ML5711		U/U
ML6002		U/U
ML6367⁰		U/P

CARNIVAL

CARNIVAL II (GQ)	1.99 → 9.07
CARNIVAL / GRAND CARNIVAL III (VQ)	9.05 →

ML5706		P/U
ML5706		P/U

ML5709		U/U
ML6118		U/C1
ML6234		U/K

CEE'D

CEE'D Hatchback (ED)	12.06 → 12.12
CEE'D SW (ED)	9.07 → 12.12

ML5723		S1/S1
ML5839		U/K

CERATO

CERATO (LD)	4.04 →
-------------	--------

--	--	--

ML5713		U/U
---------------	--	-----

MAGENTIS

MAGENTIS (GD, MS)	5.01 →
MAGENTIS (MG)	11.05 →

ML6341⁰		U/C1
ML6342⁰		P/C1

ML5710		U/U

OPTIMA

OPTIMA	6.10 →
--------	--------

ML6343⁰		P/C1
---------------------------	--	------

--	--	--

PICANTO

PICANTO (BA)	4.04 →
PICANTO (TA)	5.11 →

ML5708		U/U
ML6170		7b/13

RIO

RIO Estate (DC)	8.00 → 2.05
RIO II (JB)	3.05 →
RIO III (UB)	9.11 →

ML6303		U/C1
ML5712		P/U
ML6235		U/C1

SORENTO

SORENTO I (JC)	8.02 →
SORENTO II (XM)	11.09 →

ML5705		S1/U

ML5707		U/U
ML5823		S1/S1
ML6119		U/C1



LANCIA

**SOUL**

SOUL (AM)	2.09 →					ML6236		U/C1
-----------	--------	--	--	--	--	--------	--	------

SPORTAGE

SPORTAGE (JE_, KM_)	9.04 →					ML5912		S1/U
---------------------	--------	--	--	--	--	--------	--	------

SPORTAGE (SL)	6.10 →					ML6206		U/C1
---------------	--------	--	--	--	--	--------	--	------

VENGA

VENGA (YN)	2.10 →					ML6171		7b/13
------------	--------	--	--	--	--	--------	--	-------

LADA**111**

111 (2111)	1.95 →					ML5107		U/U
------------	--------	--	--	--	--	--------	--	-----

112

112 (2112)	1.95 → 12.11					ML5108		U/U
------------	--------------	--	--	--	--	--------	--	-----

KALINA

KALINA Hatchback (1119)	10.04 → 12.13					ML6273 ⁰		U/U
-------------------------	---------------	--	--	--	--	---------------------	--	-----

KALINA Saloon (1118)	10.04 →					ML6272 ⁰		U/S2
----------------------	---------	--	--	--	--	---------------------	--	------

KALINA Estate (1117)	10.04 →					ML6304 ⁰		U/U
----------------------	---------	--	--	--	--	---------------------	--	-----

NADESCHDA

NADESCHDA (2120)	12.97 → 12.06					ML5299		U/U
------------------	---------------	--	--	--	--	--------	--	-----

NIVA

NIVA (2121)	12.76 →				ML5114		U/U	ML5025		U/U
-------------	---------	--	--	--	--------	--	-----	--------	--	-----

NIVA II (2123)	9.02 →				ML5114		U/U	ML5025		U/U
----------------	--------	--	--	--	--------	--	-----	--------	--	-----

NOVA

NOVA Estate (2104)	9.85 → 4.12					ML5298		U/U
--------------------	-------------	--	--	--	--	--------	--	-----

PRIORA

PRIORA Hatchback (2172)	12.08 →					ML6279 ⁰		U/U
-------------------------	---------	--	--	--	--	---------------------	--	-----

PRIORA Estate (2171)	10.09 →					ML6278 ⁰		U/U
----------------------	---------	--	--	--	--	---------------------	--	-----

SAMARA

SAMARA (2108, 2109, 2115, 2113, 2114)	1.86 → 12.06					ML5024		U/C1
---------------------------------------	--------------	--	--	--	--	--------	--	------

LANCIA**A 112**

A 112	3.78 → 12.86					ML5017		U/X2
-------	--------------	--	--	--	--	--------	--	------

LANCIA

LANCIA

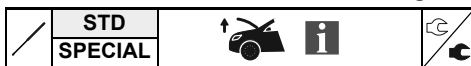

DEDRA

DEDRA (835_)	4.89 → 7.99					ML5617		N/N
DEDRA SW (835_)	7.94 → 7.99					ML5300		U/U

DELTA

DELTA I (831_)	9.79 → 1.94					ML5618		N/N
DELTA II (836_)	6.93 → 8.99					ML5540 (+)		S2/S2
DELTA III (844_)	8.08 → 8.14					ML5303		S1/S1
						ML6003		U/P

KAPPA

KAPPA (838_)	8.94 → 10.01		ML5482		S1/S1	ML5483		S1/S1
KAPPA Coupe (838_)	11.96 → 3.01		ML5482		S1/S1			
KAPPA SW (838_)	7.96 → 10.01		ML5482		S1/S1	ML5541		S1/S1

LYBRA

LYBRA (839_)	7.99 → 10.05		ML5484		S1/S1	ML5301		U/U
LYBRA SW (839_)	7.99 → 10.05		ML5484		S1/S1	ML5302		U/U

MUSA

MUSA (350_)	10.04 → 9.12					ML5702		P/S1
-------------	--------------	--	--	--	--	--------	--	------

PHEDRA

PHEDRA (179_)	9.02 → 11.10					ML5496	OE nr: 6976369	Y1/D
---------------	--------------	--	--	--	--	--------	----------------	------

PRISMA

PRISMA (831_)	1.83 → 2.92					ML5619		N/N
---------------	-------------	--	--	--	--	--------	--	-----

Y

Y (840_)	11.95 → 9.03					ML5159		S1/S1
----------	--------------	--	--	--	--	--------	--	-------

Y10

Y10 (156_)	3.85 → 12.95					ML5139		S1/S1
------------	--------------	--	--	--	--	--------	--	-------

YPSILON

YPSILON (843_)	10.03 → 12.11					ML5703		P/U
----------------	---------------	--	--	--	--	--------	--	-----

ZETA

ZETA (22_)	5.95 → 9.02					ML5305		U/U
------------	-------------	--	--	--	--	--------	--	-----

LAND ROVER

88/109

88/109 (LR_)	9.63 → 12.86					ML5306		U/U
--------------	--------------	--	--	--	--	--------	--	-----

DISCOVERY

DISCOVERY III (LA_)	7.04 → 9.09		ML5870		S1/S1	ML5871		S1/S1
---------------------	-------------	--	--------	--	-------	--------	--	-------

**FREELANDER**

FREELANDER 2 (LF_) 10.06 → 10.14	ML6006		U/U	ML6005		S1/S1
-----------------------------------	---------------	--	-----	---------------	--	-------

RANGE ROVER

RANGE ROVER I (AE, AN, HAA, HAB, HAM, HBM, RE, RN)				ML5306		U/U
RANGE ROVER II (LP_)				ML5649		U/U
RANGE ROVER III (LM_)	ML6004		S1/S1	ML5872		S1/S1
RANGE ROVER EVOQUE (LV_)				ML6207		U/C1
RANGE ROVER SPORT (LS_)	ML5870		S1/S1	ML6209		U/U
RANGE ROVER SPORT (LW_)				ML6305		U/C1

LEXUS**GS**

GS (GRS19_, UZS19_, URS19_)	ML6008		S1/S1	ML6145		S1/S3
-----------------------------	---------------	--	-------	---------------	--	-------

IS

IS I (JCE1_, GXE1_)	ML6009		S1/S1			
IS SportCross	ML6009		S1/S1			
IS II (GSE2_, ALE2_, USE2_)	ML6009		S1/S1			

RX

RX (MHU3_, GSU3_, MCU3_)				ML6331⁰		U/U
--------------------------	--	--	--	---------------------------	--	-----

MAZDA**2**

2 (DY)				ML5765		T1/T1
2 (DE)				ML5873		U/P

3

3 (BK)				ML5763		T1/T1
3 Saloon (BK)				ML5764		U/U
3 (BL)				ML6120		U/U

5

5 (CW)				ML6308		S1/S1
--------	--	--	--	---------------	--	-------

6

6 Hatchback (GG)	ML6011		U/U	ML5683		P/U
6 (GG)				ML6014		U/K
6 Station Wagon (GY)				ML5684		U/U
6 Hatchback (GH)	ML6011		U/U	ML6012		P/P

MAZDA



	STD				STD			
	SPECIAL							
6 (GH)	8.07 →							
6 Estate (GH)	2.08 →	ML6011						U/U
		ML6011			ML6013			S1/S1

121

121 III (JASM, JBSM)	3.96 → 4.03				ML5147			U/U
----------------------	-------------	--	--	--	---------------	--	--	-----

323

323 III Hatchback (BF)	8.85 → 8.93				ML5542			U/U
					ML5403			U/U
323 F VI (BJ)	9.98 → 5.04				ML5843			S2/16
					ML5842			S2/15

626

626 V Hatchback (GF)	5.97 → 10.02				ML5847			B2/A2
					ML5848			B1/A1
626 V Station Wagon (GW)	2.98 → 10.02				ML6338⁰			S2/16
					ML6337⁰			S2/15

CX-9

CX-9 (TB)	1.07 →				ML6238			S1/S3
					ML6237			S1/S3

MX-5

MX-5 III (NC)	3.05 →				ML5810			U/U
---------------	--------	--	--	--	---------------	--	--	-----

RX-8

RX 8 (SE17)	10.03 → 6.12				ML6015			U/U
-------------	--------------	--	--	--	---------------	--	--	-----

TRIBUTE

TRIBUTE (EP)	3.00 → 5.08				ML6306			U/P
					ML6307			P/S3

MERCEDES-BENZ

190

190 (W201)	10.82 → 8.93	ML5102			Y1/V			
------------	--------------	---------------	--	--	------	--	--	--

A-CLASS

A-CLASS (W168)	7.97 → 8.04				ML5188			U/U
A-CLASS (W169)	9.04 → 6.12				ML5717			P/U
A-CLASS (W176)	6.12 →				ML6210			U/P

B-CLASS

B-CLASS (W245)	3.05 → 11.11				ML5718			U/U
B-CLASS (W246, W242)	11.11 →				ML6172			7b/13



C-CLASS

C-CLASS Estate (S202)	6.96 → 3.01
C-CLASS (W203)	5.00 → 2.07
C-CLASS T-Model (S203)	3.01 → 8.07
C-CLASS Coupe (CL203)	3.01 → 5.08
C-CLASS (W204)	1.07 → 1.14
C-CLASS T-Model (S204)	8.07 → 8.14

ML5577	— —		U/13
ML5560	—		U/13
ML5577	— —		U/13
ML5560	—		U/13
ML5577	— —		U/13
ML5560	—		U/13
ML5715			U/C1
ML5715			U/C1

ML5307			U/U
ML6173			9/9
ML5673			U/U
ML6016	(-)		U/S3
ML5719	(+)		U/P

CLC-CLASS

CLC-CLASS (CL203)	5.08 → 6.11
-------------------	-------------

--	--	--	--

ML6017			U/U
--------	--	--	-----

CLK

CLK (C208)	6.97 → 6.02
CLK Convertible (A208)	3.98 → 3.02
CLK (C209)	6.02 → 5.09
CLK Convertible (A209)	2.03 → 3.10

ML5308			U/U
ML5308			U/U
ML5577	— —		U/13
ML5560	—		U/13
ML5577	— —		U/13
ML5560	—		U/13

ML6019			U/U
ML5808			S1/S1

CLS

CLS (C219)	10.04 → 12.10
------------	---------------

ML5309			U/U
--------	--	--	-----

--	--	--	--

E-CLASS

E-CLASS Convertible (A124)	6.93 → 3.98
E-CLASS (W210)	6.95 → 3.02
E-CLASS Estate (S210)	6.96 → 3.03
E-CLASS (W211)	3.02 → 12.08
E-CLASS T-Model (S211)	3.03 → 7.09
E-CLASS T-Model (S212)	8.09 →

ML5438			S1/S1
ML5438			S1/S1
ML5309			U/U
ML5309			U/U

ML6020			S1/10
ML5674			1/1
ML6021	(+)		1/1
ML6016			U/S3

G-CLASS

G-CLASS (W461)	9.89 →
G-CLASS (W463)	9.89 →
G-CLASS Cabrio (W463)	9.89 →

ML6309			U/C1
ML6309			U/C1
ML6309			U/C1

GL-CLASS

GL-CLASS (X164)	9.06 →
-----------------	--------

ML6313	— —		P/13
ML6312	—		P/13

MERCEDES-BENZ

MERCEDES-BENZ

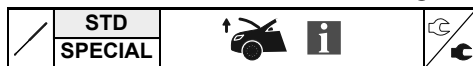

GLK-CLASS

GLK-CLASS (X204)	6.08 → 6.15
------------------	-------------

ML6311	—	U/13
ML6310	—	U/13

ML6023	(+)	U/C1
ML6022	(+)	U/C1

M-CLASS

M-CLASS (W163)	2.98 → 6.05
M-CLASS (W164)	7.05 → 12.11

ML5559		U/S2
ML6024	—	P/13
ML6025	—	P/13

ML5530		U/P
ML5806	(-)	U/P

R-CLASS

R-CLASS (W251, V251)	1.06 →
----------------------	--------

ML6027	—	U/13
ML6026	—	U/13

ML6030		M/M
---------------	--	-----

S-CLASS

S-CLASS (W220)	10.98 → 8.05
S-CLASS Coupe (C215)	3.99 → 3.06
S-CLASS (W221)	10.05 → 12.13

ML5620		U/U
ML5561		U/U
ML6029		U/13

ML6028		S1/12
ML5813		S1/S1

SL

SL (R129)	3.89 → 10.01
SL (R230)	10.01 → 1.12

ML6031		S1/10
ML5811		U/U

ML5800	Ch. n° → F 122820	U/U
ML5802	Ch. n° F 109966 → (+)	U/U
ML5801	Ch. n° F 109966 → (-)	U/U

SLK

SLK (R170)	9.96 → 4.04
SLK (R171)	3.04 → 2.11
SLK (R172)	2.11 →

ML6032		U/13
ML5799	—	U/U
ML5798	—	U/U
ML5799	—	U/U
ML5798	—	U/U

ML5680		U/U
ML5818		U/U

VANEO

VANEO (414)	2.02 → 7.05
-------------	-------------

--	--	--

ML5543		U/U
---------------	--	-----

V-CLASS

V-CLASS (638/2)	9.96 → 7.03
-----------------	-------------

--	--	--

ML5621	(-)	U/U
ML5329	(+)	U/U

VIANO

VIANO (W639)	9.03 →
--------------	--------

--	--	--

ML5716		U/U
---------------	--	-----

VITO

VITO Bus (638)	2.96 → 7.03
VITO Box (638)	3.97 → 7.03

--	--	--

ML5328	(-)	U/U
ML5329	(+)	U/U
ML5328	(-)	U/U
ML5329	(+)	U/U



MITSUBISHI



/	STD		
	SPECIAL		

/	STD		
	SPECIAL		

VITO Bus (W639)	9.03 →				
VITO / MIXTO Box (W639)	9.03 →				

ML5716		U/U
ML5716		U/U

MG

METRO

METRO	5.82 → 9.90				
-------	-------------	--	--	--	--

--	--	--	--

ML5041		U/U
--------	--	-----

MG Z

MG ZR	6.01 → 4.05				
MG ZS Hatchback	7.01 → 10.05				
MG ZT	6.01 → 7.05				
MG ZT- T	10.01 → 7.05				

ML6033		U/U	
ML6033		U/U	

ML5434		U/U
ML5410		S1/S1
ML5622 (+)		S1/S1
ML5411		S1/U
ML5412		S1/U
ML5623		S1/S1

MINI

MINI

MINI (R50, R53)	6.01 → 9.06				
MINI Convertible (R52)	7.04 → 11.07				
MINI (R56)	10.06 → 11.13				
MINI Convertible (R57)	8.08 → 6.15				
MINI Roadster (R59)	2.12 →				
MINI COUNTRYMAN (R60)	6.10 →				
MINI CLUBMAN (R55)	10.07 → 6.14				
MINI CLUBVAN (R55)	12.12 →				
MINI Coupe (R58)	12.10 → 5.15				
MINI PACEMAN (R61)	4.12 →				

ML5564		U/P
ML5564		U/P
ML6037		U/C1
ML6037		U/C1
ML6037		U/C1
ML6177		7b/44
ML6037		U/C1
ML6037		U/C1
ML6037		U/C1
ML6177		7b/44

ML5406		U/U
ML6036		U/U
ML6176		7b/13
ML6035		P/P
ML6035		P/P
ML6314		S1/S3

MITSUBISHI

CARISMA

CARISMA (DA_)	7.95 → 6.06				
---------------	-------------	--	--	--	--

--	--	--	--

ML5278		U/U
ML5354 (+)		U/U

COLT

COLT IV (CA_A)	4.92 → 4.96				
COLT VI (Z3_A, Z2_A)	6.04 → 6.12				

ML5587		S1/S1
ML5661 3		U/U
ML5662 5		U/U

GALANT

GALANT IV Saloon (E3_A)	11.87 → 10.92				
-------------------------	---------------	--	--	--	--

--	--	--	--

ML5578		U/U
--------	--	-----

MITSUBISHI

MITSUBISHI

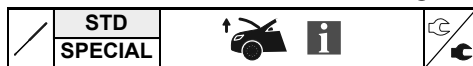

LANCER

LANCER Estate (CS_W) 9.03 → 10.08					ML5757		U/U
------------------------------------	--	--	--	--	---------------	--	-----

OUTLANDER

OUTLANDER I (CU_W) 3.01 → 12.06					ML5757		U/U
OUTLANDER II (CW_W) 11.06 → 11.12					ML5776		U/P
OUTLANDER III (GG_W, GF_W, ZJ) 8.12 →					ML6315	(-)	S1/S3

SPACE RUNNER

SPACE RUNNER (N6_W) 8.99 → 1.03					ML6039		T1/T1
----------------------------------	--	--	--	--	---------------	--	-------

SPACE STAR

SPACE STAR MPV (DG_A) 6.98 → 12.04					ML5353		U/U
-------------------------------------	--	--	--	--	---------------	--	-----

SPACE WAGON

SPACE WAGON (N9_W, N8_W) 10.98 → 12.04					ML6038		T1/T1
---	--	--	--	--	---------------	--	-------

NISSAN

ALMERA

ALMERA II Hatchback (N16) 1.00 →					ML5672		U/U
ALMERA II (N16) 7.00 →					ML5672		U/U
ALMERA TINO (V10) 8.00 →					ML5579		S1/S1

JUKE

JUKE (F15) 6.10 →					ML6211		S1/S3
--------------------	--	--	--	--	---------------	--	-------

KUBISTAR

KUBISTAR (X76) 8.03 → 10.09					ML5837		T1/T1
KUBISTAR Box (X80) 4.06 → 3.10					ML5837		T1/T1

MAXIMA

MAXIMA / MAXIMA QX IV (A32) 3.94 → 8.00	ML5624			P/T1			
MAXIMA / MAXIMA QX V (A33) 3.00 → 11.03	ML5624			P/T1			

MICRA

MICRA II (K11) 8.92 → 2.03					ML6040		U/U
MICRA III (K12) 1.03 → 6.10					ML5360		U/U
MICRA IV (K13) 5.10 →					ML5752		U/U

MURANO

MURANO I (Z50) 8.03 → 9.08					ML6316		P/P
MURANO II (Z51) 11.07 → 9.14	ML6317			U/C1	ML6318	(-)	P/P
					ML5177	(+)	U/U

**NOTE**

NOTE (E11, NE11)	3.06 → 6.12					ML5701		S1/U
NOTE (E12)	6.13 →					ML6364⁰		P/C1

PATHFINDER

PATHFINDER II (R50)	9.97 → 12.04					ML5781		U/S1
						ML5700		U/U
PATHFINDER III (R51)	1.05 →					ML6285⁰		S2/S2

PATROL

PATROL GR V Wagon (Y61)	6.97 →					ML5689	7.01 → 7.04 F1 (N): 330	S1/P
						ML6269⁰	7.04 → F1 (N): 390	S1/P

PRIMASTAR

PRIMASTAR Bus (X83)	3.01 →					ML5516		T1/T1
PRIMASTAR Box (X83)	9.02 →					ML5516		T1/T1

PRIMERA

PRIMERA Hatchback (P10)	6.90 → 6.96					ML5317		U/U
						ML5318	(+)	U/U
						ML5324	(+)	U/U
PRIMERA (P10)	6.90 → 6.96					ML5524		T1/T1
PRIMERA Traveller (W10)	7.90 → 3.98					ML5525	(+)	T1/T1
PRIMERA Hatchback (P11)	9.96 → 7.02					ML5588		S1/S1
PRIMERA (P11)	6.96 → 12.01					ML5433		U/U
						ML5580	(+)	U/U
PRIMERA Traveller (WP11)	6.96 → 12.01					ML5321		U/U
PRIMERA Hatchback (P12)	7.02 →					ML5322	(+)	U/U
PRIMERA (P12)	1.02 →					ML5581		U/U
PRIMERA Estate (WP12)	1.02 →					ML5086		S1/S1
						ML5352		U/U
						ML5413		S1/U

PULSAR

PULSAR Hatchback (C13)	10.14 →					ML6340⁰		S1/S3
------------------------	---------	--	--	--	--	---------------------------	--	-------

QASHQAI

QASHQAI / QASHQAI +2 I (J10, JJ10)	2.07 → 12.13					ML5890		S1/S1
QASHQAI II (J11, J11_)	11.13 →					ML6363⁰		S1/P

SERENA

SERENA (C23)	11.92 → 9.01					ML5582		U/U
--------------	--------------	--	--	--	--	---------------	--	-----

SUNNY

SUNNY II Traveller (B12)	1.86 → 6.91					ML5409		U/U
SUNNY III Traveller (Y10)	11.90 → 3.00					ML6041		T1/T1

NISSAN

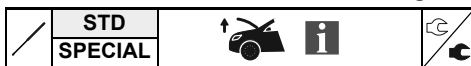

TERRANO

TERRANO II (R20)	2.93 → 9.07					ML6121		U/C1
------------------	-------------	--	--	--	--	--------	--	------

X-TRAIL

X-TRAIL (T30)	6.01 → 1.13					ML5809		S1/S1
X-TRAIL (T31)	3.07 → 11.13					ML6042		S1/S1

OPEL

AGILA

AGILA (A) (H00)	9.00 → 12.07					ML5088	→ 12.01	E2/E3
						ML5089	→ 12.01	E2/E3
AGILA (B) (H08)	4.08 →					ML6044	1.02 →	S1/S1
						ML5078		U/U

ANTARA

ANTARA	5.06 →		ML6046		U/U	ML5888		T1/T1
--------	--------	--	--------	--	-----	--------	--	-------

ASCONA

ASCONA C Hatchback (84_, 89_)	9.81 → 8.88					ML5390	(-)	U/U
						ML5395	(+)	U/U
						ML5391	(+)	U/U

ASTRA

ASTRA F Hatchback (53_, 54_, 58_, 59_)	9.91 → 1.98					ML5077		U/C1
ASTRA F Estate (51_, 52_)	9.91 → 1.98					ML5125	(+)	U/U
ASTRA F Convertible (53_B)	3.93 → 3.01					ML5156	(+) , (-)	P/P
ASTRA F CLASSIC Hatchback	1.98 → 8.02					ML6047		S1/S1
ASTRA F CLASSIC Estate	1.98 → 1.05					ML5077		U/C1
ASTRA F CLASSIC Estate	1.98 → 1.05					ML5125	(+)	U/U
ASTRA F CLASSIC Estate	1.98 → 1.05					ML5156	(+) , (-)	P/P
ASTRA G Hatchback (F48_, F08_)	2.98 → 12.09					ML5166		U/C1
ASTRA G Estate (F35_)	2.98 → 12.09					ML5167	(+) , 3	U/U
ASTRA G Convertible (F67)	3.01 → 10.05					ML5138		U/U
ASTRA H (L48)	3.04 → 5.14		ML5720		U/U	ML6146		S1/S1
ASTRA H Saloon (L69)	2.07 → 5.14		ML5720		U/U	ML5669		U/U
ASTRA H GTC (L08)	3.05 → 10.10		ML5720		U/U	ML5805	3	P/U
ASTRA H Estate (L35)	8.04 → 5.14		ML5720		U/U	ML5721		U/U
ASTRA H TwinTop (L67)	9.05 → 10.10		ML5720		U/U	ML5723		S1/S1
ASTRA CLASSIC (L48)	1.09 →		ML5720		U/U	ML5669		U/U
ASTRA CLASSIC Saloon	1.09 →		ML5720		U/U			
ASTRA CLASSIC Estate	1.09 →		ML5720		U/U	ML5721		U/U
ASTRA J	12.09 →					ML6122		P/P



	STD					STD				
	SPECIAL					SPECIAL				
ASTRA J Saloon 6.12 →						ML6335⁰				S1/S3
ASTRA GTC J 10.11 →						ML6240				U/C1
ASTRA J Sports Tourer 10.10 →						ML6178				7b/44

CALIBRA

CALIBRA A (85_) 6.90 → 7.97						ML5367				U/U
------------------------------	--	--	--	--	--	---------------	--	--	--	-----

CASCADA

CASCADA (W13) 3.13 →						ML6286				S1/S3
-----------------------	--	--	--	--	--	---------------	--	--	--	-------

COMBO

COMBO Tour 10.01 →						ML6057				U/C1
COMBO Box Body / Estate 10.01 →						ML6057				U/C1
COMBO Tour (X12) 2.12 →						ML6201				U/K

CORSA

CORSA A Hatchback (93_, 94_, 98_, 99_) 9.82 → 3.93						ML5585 (-)				O/O
						ML5527 (+)				O/O
						ML5054 (+) , (+) , 3				U/U
						ML5586 (+)				O/O
CORSA B (73_, 78_, 79_) 3.93 → 9.00						ML5242 (-) , 3				U/U
						ML5054 (+) , 3				U/U
						ML5144 5				U/U
CORSA C (F08, F68) 9.00 → 12.09						ML5120				U/C1
CORSA D 7.06 →						ML5827 3				U/U
						ML5807 5				U/U
CORSA D Van 7.06 →						ML5827 3				U/U
						ML5807 5				U/U
CORSA E 9.14 →						ML6362⁰ 3				P/P
						ML6361⁰ 5				P/P
CORSA E Van 9.14 →						ML6362⁰ 3				P/P

FRONTERA

FRONTERA B (6B_) 10.98 →						ML5825				S1/S1
						ML6043				U/U

INSIGNIA

INSIGNIA 7.08 →	ML6049					ML6051				U/U
INSIGNIA Saloon 7.08 →	ML6049									
INSIGNIA Estate 7.08 →	ML6049					ML6053 (-)				U/C1
						ML6055 (+)				U/U

KADETT

KADETT E Hatchback (33_, 34_, 43_, 44_) 9.84 → 8.91						ML5243 (-) , 3				U/U
						ML5031 (+)				U/U
						ML5244 (+) , (+)				U/U

OPEL



KADETT E Estate (35_, 36_, 45_, 46_)	9.84 → 8.91
--------------------------------------	-------------

--	--	--	--

ML5528	Ch. n° → J2502492 (+)	M/O
ML5407	Ch. n° J2502493, JE100001 →	U/U
ML5835	Ch. n° JE100000 → J2502492 (-)	M/O
ML5834	Ch. n° JE100000 → J2502492 (+)	M/O

MERIVA

MERIVA	5.03 → 5.10
MERIVA B	6.10 →

--	--	--	--

ML5119		U/U
ML6179		13/25

OMEGA

OMEGA A (16_, 17_, 19_)	9.86 → 4.94
OMEGA A Estate (66_, 67_)	9.86 → 4.94
OMEGA B (25_, 26_, 27_)	3.94 → 7.03
OMEGA B Estate (21_, 22_, 23_)	3.94 → 7.03

--	--	--	--

ML5366	Ch. n° → N1145948	U/U
ML5365	Ch. n° N1145949 →	U/U
ML5408	Ch. n° → N1145948	U/U
ML5365	Ch. n° N1145949 →	U/U
ML5210		U/U
ML5103		U/U

REKORD

REKORD E Estate (61_, 66_, 67_)	8.77 → 8.86
---------------------------------	-------------

--	--	--	--

ML5398		U/U
---------------	--	-----

SENATOR

SENATOR B (29_)	9.87 → 9.93
-----------------	-------------

--	--	--	--

ML5366	Ch. n° → N1145948	U/U
ML5365	Ch. n° N1145949 →	U/U

SIGNUM

SIGNUM	5.03 →
--------	--------

ML5345		U/U
---------------	--	-----

ML5817		P/U
---------------	--	-----

SINTRA

SINTRA	11.96 → 4.99
--------	--------------

--	--	--	--

ML5515		U/U
---------------	--	-----

TIGRA

TIGRA (95_)	7.94 → 12.00
-------------	--------------

--	--	--	--

ML5369		U/U
---------------	--	-----

VECTRA

VECTRA A Hatchback (88_, 89_)	4.88 → 11.95
VECTRA B Hatchback (38_)	10.95 → 7.03
VECTRA B (36_)	10.95 → 4.02
VECTRA B Estate (31_)	11.96 → 7.03
VECTRA C GTS	8.02 →
VECTRA C	4.02 →
VECTRA C Estate	10.03 →

ML5085		U/U	
ML5085		U/U	
ML5085		U/U	
ML5345		U/U	
ML5345		U/U	
ML5345		U/U	

ML5032		U/U
ML5258	(+)	U/U
ML5082	Ch. n° W7999999 → W5999999 5	U/U
ML5257	Ch. n° X1000001- →	U/U
ML5179	Ch. n° X1000001 →	S1/S1
ML5424		U/S1
ML5773		U/U
ML5341		U/U
ML5346		U/U

VIVARO

VIVARO Box (F7)	8.01 →
-----------------	--------

--	--	--	--

ML5516		T1/T1
---------------	--	-------

**ZAFIRA**

ZAFIRA A (F75_)	4.99 → 6.05					ML5137		U/U
ZAFIRA B (A05)	7.05 →					ML5722		U/U
ZAFIRA TOURER C (P12)	10.11 →					ML6239		U/C1

PEUGEOT**106**

106 I (1A, 1C)	8.91 → 4.96					ML5133		U/U
106 II (1)	4.96 →				ML5268			U/U
106 Van (1_)	9.91 → 3.01				ML5268			U/U

107

107	6.05 →					ML5687		U/U
-----	--------	--	--	--	--	--------	--	-----

108

108	5.14 →					ML6353 ⁰		S1/S3
-----	--------	--	--	--	--	---------------------	--	-------

205

205 I (741A/C)	2.83 → 10.87					ML5020		U/U
205 II (20A/C)	1.87 → 9.98					ML5020		U/U
205 Box	2.83 → 7.90					ML5020		U/U
205 Box	3.94 →					ML5020		U/U

206

206 Hatchback (2A/C)	8.98 →					ML5146		S1/S1
206 Van	4.99 → 3.09					ML5146		S1/S1
206 Saloon	3.07 →					ML6061		U/U
206 SW (2E/K)	7.02 →					ML5469		S1/S1
206 CC (2D)	9.00 →					ML5340		U/U
						ML5343		U/U

206+

206+ (T3E)	1.09 →					ML5146		S1/S1
------------	--------	--	--	--	--	--------	--	-------

207

207 (WA_, WC_)	2.06 →					ML5731		S1/P
207 CC (WD_)	2.07 →					ML5851		S1/S1
207 SW (WK_)	2.07 →					ML5732		S1/S1
207 Van	4.07 →					ML5733		S1/S1
						ML5731		S1/P

208

208	3.12 →					ML6180		9/43
208 Box	10.12 →					ML6180		9/43

PEUGEOT

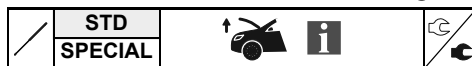

305

305 I (581A)	11.77 → 9.82
305 I Break (581D)	8.80 → 9.82
305 II (581M)	10.82 → 7.90
305 II Break (581E)	10.82 → 12.88

ML5628		U/U
ML5364		U/U
ML5628		U/U
ML5364		U/U

306

306 Hatchback (7A, 7C, N3, N5)	4.93 → 5.01
306 (7B, N3, N5)	2.94 → 5.01
306 Break (7E, N3, N5)	2.97 → 4.02
306 Convertible (7D, N3, N5)	3.94 → 4.02
306 Van (N_, 7_)	2.94 → 8.02

ML5267		S1/S1
ML5267		S1/S1
ML5267		S1/S1
ML5267		S1/S1
ML5267		S1/S1

ML5148		U/U
ML5323		U/U
ML5432		S1/S1
ML5148		U/U

307

307 (3A/C)	8.00 →
307 Break (3E)	3.02 →
307 SW (3H)	3.02 →

ML5160		S1/S1
ML5425		U/C1
ML5425		U/C1

308

308 (4A_, 4C_)	9.07 →
308 SW	9.07 →

ML5734		S1/S1
ML6058	(+)	S1/S1
ML5889	(+)	S1/S1
ML6060		S1/S1

309

309 I (10C, 10A)	10.85 → 12.89
309 II (3C, 3A)	7.89 → 12.93

ML5202		U/U
ML5202		U/U

405

405 I Break (15E)	6.87 → 8.92
405 II Break (4E)	8.92 → 10.96

ML5426		U/U
ML5426		U/U

406

406 (8B)	10.95 → 6.04
406 Break (8E/F)	10.96 → 10.04
406 Coupe (8C)	3.97 → 12.04

ML5470		S1/S1
ML5470		S1/S1
ML5517		U/U

ML5180	→ 3.99	U/U
ML5183	4.99 →	U/U
ML5319		U/U
ML5471		S1/S1

407

407 (6D_)	5.04 →
407 SW (6E_)	5.04 →
407 Coupe (6C_)	10.05 →

ML5727		U/U
ML5728		U/U
ML5729		U/U
ML6280		U/U

504

504 Break (D_, F_)	4.71 → 7.86
--------------------	-------------

--	--	--	--

ML5067		Y1/X1
--------	--	-------

**505**

505 (551A)	8.79 → 9.95					ML5625		Y1/U
505 Break (551D)	4.82 → 12.93					ML5311		U/U

508

508	11.10 →					ML6181		28/9
508 SW	11.10 →					ML6213		U/C1

605

605 (6B)	6.89 → 9.99		ML5583		U/U	ML5316		U/U
----------	-------------	--	---------------	--	-----	---------------	--	-----

607

607 (9D, 9U)	2.00 →		ML5788		T1/T1	ML5358		U/U
--------------	--------	--	---------------	--	-------	---------------	--	-----

806

806 (221)	6.94 → 8.02					ML5626	→ 11.95	U/U
						ML5627	11.95 → 10.97	U/U
						ML5363	10.97 →	U/U

807

807 (E)	6.02 →					ML5344		U/U
---------	--------	--	--	--	--	---------------	--	-----

1007

1007 (KM_)	4.05 →					ML5730		U/U
------------	--------	--	--	--	--	---------------	--	-----

2008

2008	3.13 →					ML6360⁰		S1/S3
------	--------	--	--	--	--	---------------------------	--	-------

3008

3008	6.09 →					ML6123		U/U
------	--------	--	--	--	--	---------------	--	-----

4007

4007 (GP_)	2.07 →					ML5776		U/P
------------	--------	--	--	--	--	---------------	--	-----

5008

5008	6.09 →					ML6124		U/P
------	--------	--	--	--	--	---------------	--	-----

BIPPER

BIPPER (AA_)	2.08 →					ML5968		U/U
BIPPER Tepee	4.08 →					ML5968		U/U

EXPERT

EXPERT Tepee (VF3V_)	1.07 →					ML5950	(=)	U/U
EXPERT Box (VF3A, VF3U, VF3X_)	1.07 →					ML5950	(=)	U/U

PARTNER

PARTNER Combispace (5F)	5.96 →					ML5113		T1/T1
PARTNER Box (5)	4.96 →					ML5113		T1/T1

PEUGEOT

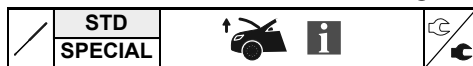

PARTNER Tepee	4.08 →
PARTNER Box	4.08 →

ML5948		U/S1
ML5954	→ Org n° 118229	U/U
ML5956	Org n° 118230 →	S1/S3
ML5948		U/S1
ML5954	→ Org n° 118229	U/U
ML5956	Org n° 118230 →	S1/S3

RCZ

RCZ	3.10 →
-----	--------

ML6253		S1/S3
--------	--	-------

--	--	--

PORSCHE

911

911	1.63 → 11.90
911 Targa Targa	8.67 → 8.75
911 (964)	12.88 → 9.93
911 Convertible (964)	5.89 → 5.94
911 Speedster (964)	8.92 → 6.94
911 (993)	10.93 → 9.97
911 Convertible (993)	7.94 → 9.97
911 (996)	9.97 → 8.05
911 Convertible (996)	2.98 → 8.05
911 (997)	7.04 → 12.12
911 Convertible (997)	4.05 → 12.12
911 Targa (997) Targa	7.06 → 12.12
911 (991)	12.11 →
911 Convertible (991)	3.12 →

ML5646		Y5/X3
ML5646		Y5/X3
ML6062		S1/D
ML6062		S1/D
ML6062		S1/D
ML6062		S1/D
ML6062		S1/D
ML6147		S1/S1
ML6147		S1/S1
ML5803		S1/S1
ML5803		S1/S1
ML5803		S1/S1
ML6251		Y5/X3
ML6251		Y5/X3

ML5595		Y5/X3
ML5594 (+)		Y5/X3
ML5595		Y5/X3
ML5594 (+)		Y5/X3
ML6065		U/C1
ML5804		U/U
ML5804		U/U

924

924	11.75 → 8.89
-----	--------------

ML5846		U/D
--------	--	-----

--	--	--

928

928	9.77 → 11.95
-----	--------------

ML5676		U/U
--------	--	-----

--	--	--

944

944	6.81 → 7.91
944 Convertible	12.88 → 7.91

ML5846		U/D
ML5846		U/D

BOXSTER

BOXSTER (986)	9.96 → 12.04
BOXSTER (987)	11.04 → 12.11
BOXSTER Spyder (987)	9.07 → 12.11

ML6147		S1/S1
ML5803		S1/S1
ML5803		S1/S1

ML6066		S1/S1
ML6067		S1/S1
ML6067		S1/S1

CAYENNE

CAYENNE (9PA)	9.02 → 9.10
CAYENNE (92A)	6.10 →

ML6069		U/P
ML6319		U/C1

ML6068		U/C1

**CAYMAN**

CAYMAN (987)	11.05 → 6.13	ML5803	S1/S1	ML6241	S1/S3
--------------	--------------	--------	-------	--------	-------

RENAULT**5**

SUPER 5 (B/C40_)	10.84 → 12.96			ML5021		U/U
				ML5337	Baccara	U/U

11

11 (B/C37_)	3.83 → 12.88			ML5630		S1/S1
11 Box (S37_)	3.83 → 12.88			ML5630		S1/S1

19

19 I (B/C53_)	1.88 → 9.94			ML5004		U/U
19 I Chamade (L53_)	1.88 → 12.92			ML5310		U/U
19 II (B/C53_)	1.92 → 12.98			ML5094		U/U
19 II Chamade (L53_)	4.92 → 12.95			ML5256 (+)		U/U
19 II Chamade (L53_)	4.92 → 12.95			ML5553		U/U
19 II Box (S53_)	3.92 → 12.95			ML5094		U/U
19 II Box (S53_)	3.92 → 12.95			ML5256 (+)		U/U

21

21 (B48_)	7.89 → 6.94			ML5631		T1/T1
21 Estate (K48_)	3.86 → 9.95			ML5632		Y1/D

25

25 (B29_)	4.84 → 12.92	ML5633	→ 8.86	Y1/D		
		ML5549	9.86 →	T1/D		

AVANTIME

AVANTIME (DE0_)	9.01 → 5.03			ML5351		U/U
-----------------	-------------	--	--	--------	--	-----

CLIO

CLIO I (B/C57_, 5/357_)	5.90 → 9.98			ML5093		S1/S1
CLIO I Box (S57_)	1.91 → 9.98			ML5254	Baccara-Williams	U/U
CLIO II (BB0/1/2_, CB0/1/2_)	9.98 →			ML5093		S1/S1
CLIO II Box (SB0/1/2_)	9.98 →			ML5254	Baccara-Williams	U/U
CLIO II Box (SB0/1/2_)	9.98 →			ML5241		U/U
CLIO III (BR0/1, CR0/1)	5.05 →			ML5241		U/U
CLIO III Box (SB_, SR_)	6.05 → 7.10			ML5725		S1/S1
CLIO III Box (SB_, SR_)	6.05 → 7.10			ML5725		S1/S1
CLIO Grandtour (KR0/1_)	2.08 →			ML5656		P/P
CLIO IV (BH_)	11.12 →	ML6215	S1/S3	ML6214		S1/S3
CLIO IV Grandtour (KH_)	1.13 →	ML6215	S1/S3			

RENAULT

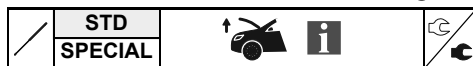

ESPACE

ESPACE I (J11_)	7.84 → 12.92
ESPACE II (J/S63_)	1.91 → 12.96
ESPACE III (JE0_)	11.96 → 10.02
ESPACE IV (JK0/1_)	11.02 →

	ML5473		S1/S1
	ML5472	→ 7.04	S1/S1

	ML5320		U/U
	ML5629		R/R
	ML5313	→ 11.93	U/U
	ML5314	11.93 →	U/U
	ML5546		R/R
	ML5228	(+)	U/K
	ML5229	(+)	U/U
	ML5230		S1/S1
	ML5518	(+)	U/U
	ML5519	(+)	U/U
	ML5551		S1/S1

FLUENCE

FLUENCE (L30_)	2.10 →
----------------	--------

--	--	--	--

	ML6242		S1/S3
--	---------------	--	-------

GRAND SCÉNIC

GRAND SCÉNIC II (JM0/1_)	4.04 →
GRAND SCÉNIC III (JZ0/1_)	2.09 →

	ML6127		U/S1

	ML5826	(+)	U/C1
	ML5475	(+)	U/U
	ML5552		S1/S1
	ML6125		S1/S1

KANGOO

KANGOO (KC0/1_)	8.97 →
KANGOO Express (FC0/1_)	8.97 →
KANGOO / GRAND KANGOO (KW0/1_)	2.08 →
KANGOO Express (FW0/1_)	2.08 →
KANGOO BE BOP (KW0/1_)	2.09 →

	ML5128		S1/S1
	ML5128		S1/S1
	ML5892		S1/S1
	ML5892		S1/S1
	ML5892		S1/S1

KOLEOS

KOLEOS (HY_)	9.08 →
--------------	--------

--	--	--	--

	ML6070		U/C1
--	---------------	--	------

LAGUNA

LAGUNA I (B56_, 556_)	11.93 → 3.01
LAGUNA I Grandtour (K56_)	9.95 → 3.01
LAGUNA II (BG0/1_)	3.01 →
LAGUNA II Grandtour (KG0/1_)	3.01 →
LAGUNA III (BT0/1)	10.07 →

	ML5544		U/S1
	ML5545	(+)	U/S1
	ML5279		S1/U
	ML5383		U/S1
	ML5547		S1/S1
	ML5189		S1/S1
	ML5190	(+)	S1/S1
	ML5474	(+)	S1/S1
	ML5440	(+)	S1/S1
	ML5548		S1/S1
	ML5657		S1/S1



RENAULT

	STD				STD			
	SPECIAL				SPECIAL			
LAGUNA III Grandtour (KT0/1) 10.07 →					ML5893			S1/S1
LAGUNA Coupe (DT0/1) 9.08 →					ML6063			S1/P
					ML6126			S1/S1

LATITUDE

LATITUDE (L70_) 7.10 →					ML6243			U/C1
-------------------------	--	--	--	--	--------	--	--	------

LOGAN

LOGAN I Estate (KS_) 4.07 →					ML5864			U/U
------------------------------	--	--	--	--	--------	--	--	-----

MEGANE

MEGANE I (BA0/1_) 8.95 → 8.03					ML5131	5		U/C1
MEGANE I Classic (LA0/1_) 9.96 → 8.03					ML5182			S1/S1
MEGANE I Grandtour (KA0/1) 3.99 → 8.03					ML5158			U/U
MEGANE I Coach (DA0/1_) 3.96 → 8.03					ML5526			S1/14
MEGANE I Cabriolet (EA0/1_) 10.96 → 8.03					ML5686			U/U
MEGANE Scenic (JA0/1_) 10.96 → 10.99					ML5152	(+)		U/C1
					ML5130	(+)		U/C1
MEGANE II (BM0/1_, CM0/1) 11.02 → 12.09					ML5212			U/U
MEGANE II Saloon (LM0/1_) 9.03 →					ML5789			U/U
MEGANE II Estate (KM0/1_) 8.03 → 8.09					ML5372	(+)		U/U
					ML5828	(+)		U/P
					ML5812			U/U
MEGANE II Coupé-Cabriolet (EM0/1_) 9.03 → 12.09					ML5894			U/U
MEGANE III Hatchback (BZ0_) 11.08 →	ML6074			U/Q	ML6071			U/U
MEGANE III Grandtour (KZ0/1) 11.08 →	ML6074			U/Q	ML6073			U/U
MEGANE III Coupe (DZ0/1_) 11.08 →	ML6074			U/Q	ML6072			U/U
MEGANE CC (EZ0/1_) 6.10 →	ML6074			U/Q	ML6244			U/K

MODUS

MODUS / GRAND MODUS (F/JPO_) 9.04 →					ML6075			U/K
					ML5724			S1/S1

RAPID

RAPID Box (F40_, G40_) 7.85 → 11.98					ML5315			U/U
--------------------------------------	--	--	--	--	--------	--	--	-----

SAFRANE

SAFRANE I (B54_) 4.92 → 7.96	ML5327			U/U	ML5554			U/T1
					ML5555	Baccara		U/T1
SAFRANE II (B54_) 7.96 → 12.00	ML5327			U/U	ML5476	F1 (N): 530		S1/S1
					ML5477	F1 (N): 620		S1/S1

RENAULT

RENAULT



SCÉNIC

SCÉNIC I (JA0/1_)	9.99 → 9.03
SCÉNIC II (JM0/1_)	6.03 →
SCÉNIC III (JZ0/1_)	2.09 →

ML6127			U/S1

ML5152	(+)	U/C1
ML5130	(+)	U/C1
ML5153		S1/S1
ML5826	(+)	U/C1
ML5475	(+)	U/U
ML5552		S1/S1
ML6128		S1/S1

TRAFIC

TRAFIC II Bus (JL)	3.01 →
TRAFIC II Box (FL)	3.01 →

ML5550		T1/T1
ML5550		T1/T1

TWINGO

TWINGO I (C06_)	3.93 →
TWINGO I Box (S06_)	3.93 →
TWINGO II (CN0_)	3.07 →
TWINGO III (BCM_)	9.14 →

ML5331		U/K
ML5331		U/K
ML5891		S1/S1
ML6339⁰		S1/S3

ROVER

25

25 (RF)	10.99 → 5.05
---------	--------------

--	--	--	--

ML5434		U/U
---------------	--	-----

45

45 (RT)	2.00 → 5.05
45 Saloon (RT)	2.00 → 5.05

ML5410		S1/S1
ML5478	(+)	S1/S1
ML5410		S1/S1
ML5478	(+)	S1/S1

75

75 (RJ)	2.99 → 5.05
75 Tourer (RJ)	8.01 → 5.05

ML6033		U/U
ML6033		U/U

ML5411		S1/U
ML5412		S1/U
ML5623		S1/S1

100

100 / METRO (XP)	3.90 → 12.98
------------------	--------------

--	--	--	--

ML5208	(-)	U/U
ML5209	(+)	U/U

200

200 Hatchback (XW)	10.89 → 10.95
200 Saloon (XH)	3.85 → 9.89
200 Coupe (XW)	10.92 → 6.99
200 Hatchback (RF)	11.95 → 3.00

ML5192		U/U
ML5634	GTI	T1/T1
ML5634		T1/T1
ML6148		S1/S1
ML5434		U/U



SAAB

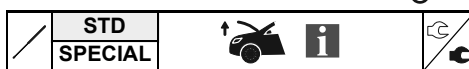

400

400 Hatchback (RT)	5.95 → 3.00
--------------------	-------------

--	--	--	--

ML5410		S1/S1
ML5478	(+)	S1/S1

800

800 Hatchback (XS)	10.86 → 2.99
800 (XS)	10.86 → 2.99
800 Coupe	8.92 → 2.99

ML5359		U/U
ML5359		U/U
ML5359		U/U

ML5384	Ch. n° → 230966	U/S1
ML5338	Ch. n° 230967 →	U/U

MAESTRO

MAESTRO	9.90 → 1.95
---------	-------------

--	--	--	--

ML5362		U/U
---------------	--	-----

MINI

MINI Special Design	1.91 → 11.00
---------------------	--------------

--	--	--	--

ML5041		U/U
---------------	--	-----

STREETWISE

STREETWISE	8.03 → 5.05
------------	-------------

--	--	--	--

ML5815	(-)	U/U
ML5394	(+)	U/U

SAAB

9-3

9-3 (YS3D)	2.98 → 9.02
9-3 Cabriolet (YS3D)	2.98 → 8.03
9-3 (YS3F)	9.02 → 2.15
9-3 Convertible (YS3F)	8.03 → 2.15
9-3 Estate (YS3F)	3.05 → 2.15

ML5350	(x1)	U/U
ML5349	(x2)	U/U
ML5350	(x1)	U/U
ML5349	(x2)	U/U
ML5790		P/S1
ML5790		P/S1
ML5790		P/S1

ML5402	(-)	U/U
ML5375	(+) , (+)	U/U
ML5397	(+) , 4	U/U
ML6076		U/T1
ML5766		S1/S1
ML5766		S1/S1
ML5852		G/G

9-3X

9-3X	2.09 → 12.12
------	--------------

ML5790		P/S1
---------------	--	------

ML5852		G/G
---------------	--	-----

9-5

9-5 (YS3E)	9.97 → 12.09
9-5 Estate (YS3E)	10.98 → 12.09

ML5638	→ 12.05	U/U
ML5638	→ 12.05	U/U

ML5558		U/T1
ML5637		O/O

99

99 Combi Coupe	8.68 → 12.84
----------------	--------------

--	--	--	--

ML5613		Y1/D
---------------	--	------

900

900 I Combi Coupe	6.78 → 6.94
900 II	7.93 → 2.98

ML5636		U/U	

ML5613		Y1/D
ML5635	(+)	Y1/D
ML5400		U/U
ML5401	(+)	U/U

SAAB

SAAB

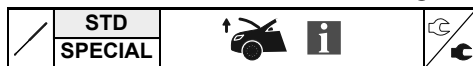

900 II Coupe	12.93 → 2.98
900 II Convertible	12.93 → 2.98

ML5636		U/U
ML5636		U/U

ML5400		U/U
ML5401	(+)	U/U

9000

9000 Hatchback	9.84 → 12.98
9000	4.85 → 12.98

ML5556		Y1/X1
ML5556		Y1/X1

ML5499	OE nr: 9253964, 6956262/70 F1(N):345	Y1/D
ML5494	OE nr: 6956288 F1(N):400	Y1/D
ML5495	OE nr: 4006078 F1(N):610	U/U
ML5557	OE nr: 4006060 F1(N):710	U/U
ML5496	OE nr: 6976369	Y1/D

SEAT

ALHAMBRA

ALHAMBRA (7V8, 7V9)	4.96 → 3.10
ALHAMBRA (710, 711)	6.10 →

ML5480		S1/S1
ML6217		U/C1

ML5127		U/U
ML6216		S1/K

ALTEA

ALTEA (5P1)	3.04 →
ALTEA XL (5P5, 5P8)	10.06 →

ML5100		S1/S1
ML5845		U/U

AROSA

AROSA (6H)	5.97 → 6.04
------------	-------------

ML5195		S1/U
---------------	--	------

ML5284		S1/U
---------------	--	------

CORDOBA

CORDOBA (6K1, 6K2)	2.93 → 10.99
CORDOBA Vario (6K5)	8.96 → 6.99
CORDOBA (6K2)	6.99 → 10.02
CORDOBA Vario (6K5)	6.99 → 12.02
CORDOBA (6L2)	9.02 → 11.09

ML5063		U/U
ML5100		S1/S1
ML5259		U/U
ML5100		S1/S1
ML5778		S1/U

EXEO

EXEO (3R2)	12.08 →
EXEO ST (3R5)	5.09 →

ML5386		U/U
ML5386		U/U

ML5745		U/U
ML6129		U/U

IBIZA

IBIZA I (021A)	6.84 → 12.93
IBIZA II (6K1)	3.93 → 8.99
IBIZA III (6K1)	8.99 → 2.02
IBIZA IV (6L1)	2.02 → 11.09
IBIZA V (6J5, 6P1)	3.08 →
IBIZA V SPORTCOUPE (6J1, 6P5)	7.08 →
IBIZA V ST (6J8, 6P8)	3.10 →

ML5022		Y1/X1
ML5140		U/U
ML5211		U/U
ML5225		S1/U
ML5850		S1/P
ML5850		S1/P
ML6183		9/13

LEON

LEON (1M1)	11.99 → 6.06
LEON (1P1)	5.05 → 12.12

ML5342		U/U

ML5181		S1/U
ML5767		S1/U



ŠKODA

MONROE	STD					STD				
	SPECIAL					SPECIAL				
LEON SC (5F5)	1.13	→				ML6320				U/C1
LEON ST (5F8)	8.13	→				ML6321				U/P

MALAGA

MALAGA (023A)	11.84	→ 12.93				ML5639				Y1/D
---------------	-------	---------	--	--	--	---------------	--	--	--	------

MARBELLA

MARBELLA (28)	8.86	→ 10.98				ML5016	→ Vet n° 6314421, 5370347			Y1/X2
---------------	------	---------	--	--	--	---------------	---------------------------	--	--	-------

Mii

Mii (KF1_)	10.11	→				ML6245				U/C1
------------	-------	---	--	--	--	---------------	--	--	--	------

PANDA

PANDA (141A)	10.80	→ 12.86				ML5016	→ Vet n° 6314421, 5370347			Y1/X2
--------------	-------	---------	--	--	--	---------------	---------------------------	--	--	-------

RITMO

RITMO (138)	7.78	→ 9.83				ML5010				Y1/X1
-------------	------	--------	--	--	--	---------------	--	--	--	-------

RONDA

RONDA (022A)	6.82	→ 11.88				ML5011				Y1/X1
						ML5501	(+)			Y2/D

TOLEDO

TOLEDO I (1L)	5.91	→ 3.99				ML5124				U/U
TOLEDO II (1M2)	10.98	→ 5.06			ML5342				U/U	U/U
TOLEDO III (5P2)	4.04	→ 5.09				ML5584				S1/U

ŠKODA**FABIA**

FABIA (6Y2)	8.99	→ 3.08				ML5175				U/C1
FABIA Saloon (6Y3)	10.99	→ 12.07				ML5135				U/U
FABIA Combi (6Y5)	4.00	→ 12.07				ML5175				U/C1
FABIA (542)	12.06	→ 12.14				ML5681				U/U
FABIA Combi (545)	10.07	→ 12.14				ML5681				U/U

FAVORIT

FAVORIT (781)	5.89	→ 9.94				ML5048				U/U
FAVORIT Forman (785)	8.91	→ 6.95				ML5005	Forman			U/U
FAVORIT Pickup (787)	6.92	→ 6.97				ML5037	Forman Plus			U/P
						ML5044	(+)			U/U
						ML5044	(+)			U/U
						ML5036				Y1/X1
						ML5026	(+) Panoramic			U/U

ŠKODA



FELICIA

FELICIA I (6U1)	10.94 → 3.98
FELICIA I Estate (6U5)	8.95 → 3.98
FELICIA I Fun (797)	6.97 → 4.02

ML5061		U/C1
ML5061		U/C1
ML5099	F1(N):220	U/U
ML5057	F1(N):325	P/S1

OCTAVIA

OCTAVIA (1U2)	9.96 → 12.10
OCTAVIA Combi (1U5)	7.98 → 12.10
OCTAVIA (1Z3)	2.04 → 6.13
OCTAVIA Combi (1Z5)	2.04 → 6.13
OCTAVIA (5E3)	11.12 →
OCTAVIA Combi (5E5)	11.12 →

ML5217	F1(N):470	U/U
ML5221	Sport RS	U/U
ML5218	F1(N):500, (-)	U/U
ML5219	F1(N):515, (+)	U/U
ML5045		U/C1
ML5665		U/U
ML6332⁰	(+)	U/U
ML5667		U/U
ML6289		U/C1
ML6288	(-)	U/C1

RAPID

RAPID Spaceback (NH1)	7.12 →
-----------------------	--------

--	--	--	--

ML6322		U/C1
---------------	--	------

ROOMSTER

ROOMSTER (5J)	5.06 → 5.15
---------------	-------------

--	--	--	--

ML5682		U/U
---------------	--	-----

SUPERB

SUPERB (3U4)	12.01 → 3.08
SUPERB (3T4)	3.08 → 5.15
SUPERB Estate (3T5)	10.09 → 5.15

ML5768		U/U
ML6079		P/U
ML6079		P/U

ML5439		U/U
ML6081	↓	S1/S1
ML6080	↑	U/U
ML6218		U/C1

YETI

YETI (5L)	5.09 →
-----------	--------

--	--	--	--

ML6130		P/U
---------------	--	-----

SMART

CITY-COUPÉ

CITY-COUPÉ (450)	7.98 → 1.04
------------------	-------------

--	--	--	--

ML5640		T1/T1
---------------	--	-------

FORFOUR

FORFOUR (454)	1.04 → 6.06
---------------	-------------

--	--	--	--

ML5895		U/U
---------------	--	-----

FORTWO

FORTWO Coupe (450)	1.04 → 2.07
FORTWO Coupe (451)	1.07 →

ML6083		S1/S3
ML6083		S1/S3

ROADSTER

ROADSTER Coupe (452)	4.03 → 11.05
----------------------	--------------

--	--	--	--

ML6082		S1/S1
---------------	--	-------



SUZUKI

MONROESTD
SPECIALSTD
SPECIAL**SSANGYONG****REXTON**

REXTON (GAB_)	4.02 →	ML5355		U/U	ML5334		U/U
					ML5356		U/U

SUBARU**IMPREZA**

IMPREZA Estate (GF)	8.92 → 12.00				ML5820		U/U
IMPREZA Estate (GG)	12.00 →				ML5819		U/U

JUSTY

JUSTY IV	1.07 →				ML6084		T1/T1
----------	--------	--	--	--	--------	--	-------

SUZUKI**ALTO**

ALTO (0S)	6.82 → 8.84				ML5589		S1/S1
ALTO	1.86 → 12.88				ML5589		S1/S1
ALTO (EC)	12.88 → 11.93				ML5589		S1/S1
ALTO (EF)	9.94 → 9.98				ML5589		S1/S1
ALTO (HA12, HA23)	1.00 → 6.02				ML5589		S1/S1
ALTO (GF)	1.09 →				ML6131		U/U

DZIRE

DZIRE	7.13 → 6.15				ML6219		U/C1
-------	-------------	--	--	--	--------	--	------

IGNIS

IGNIS II (MH)	9.03 →				ML5780		T1/T1
---------------	--------	--	--	--	--------	--	-------

JIMNY

JIMNY (FJ)	9.98 →				ML5492		Y1/D
------------	--------	--	--	--	--------	--	------

SAMURAI

SAMURAI (SJ)	11.88 → 12.04				ML5492		Y1/D
--------------	---------------	--	--	--	--------	--	------

SJ

SJ 410	9.81 → 12.88				ML5492		Y1/D
SJ 410 Cabrio (OS)	9.81 → 12.88				ML5492		Y1/D
SJ 413 (OS)	9.84 → 8.90				ML5492		Y1/D

SPLASH

SPLASH (EX)	1.08 →				ML5078		U/U
-------------	--------	--	--	--	--------	--	-----

SUZUKI

SUZUKI

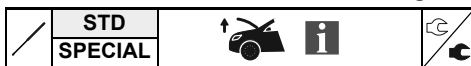

SWIFT

SWIFT I (AA)	10.83 → 12.89
SWIFT II Hatchback (EA, MA)	3.89 → 12.05
SWIFT III (MZ, EZ)	2.05 →
SWIFT IV (FZ, NZ)	10.10 →

ML5492		Y1/D
ML5091		E4/T1
ML5092		E4/T1
ML6086		U/U
ML6219		U/C1

SX4

SX4 (EY, GY)	6.06 →
SX4 S-Cross (JY)	8.13 →

ML5779		U/U
ML6336⁰		S1/S3

VITARA

VITARA (ET, TA)	7.88 → 3.98
VITARA (ET)	12.03 → 12.05

ML5493	(+) Panoramic	S1/S1
ML6085		11/11
ML6085		11/11
ML5493	(+) Panoramic	S1/S1

WAGON R+

WAGON R+ (MM)	5.00 →
---------------	--------

--	--	--	--

ML5088	→ 12.01	E2/E3
ML5089	→ 12.01	E2/E3
ML6044	1.02 →	S1/S1

TOYOTA

AURIS

AURIS (_E15_)	10.06 → 9.12
AURIS TOURING SPORTS (_E18_)	7.13 →

ML5900		S1/S1
ML6359⁰		S1/S3

AVENSIS

AVENSIS (_T22_)	9.97 → 2.03
AVENSIS Liftback (_T22_)	9.97 → 2.03
AVENSIS Station Wagon (_T22_)	9.97 → 2.03
AVENSIS (_T25_)	4.03 → 11.08
AVENSIS Estate (_T25_)	4.03 → 11.08
AVENSIS Estate (_T27_)	2.09 →

ML5592		S1/S1
ML5592		S1/S1
ML5121		S1/S1
ML5647		P/S1
ML5699		P/S1
ML6132		S1/S1

AYGO

AYGO (_B1_)	7.05 →
-------------	--------

--	--	--	--

ML6151		S1/C1
---------------	--	-------

CAMRY

CAMRY Saloon (_V3_)	8.01 → 11.06
CAMRY Saloon (_V4_)	1.06 → 9.11

ML6323		S1/S3
ML6368⁰		P/C1
ML6368⁰		P/C1

**CARINA E**

CARINA E (_T19_)	4.92 → 9.97					ML6089		T1/T1
------------------	-------------	--	--	--	--	---------------	--	-------

COROLLA

COROLLA Compact (_E11_)	4.97 → 1.02					ML6087	(-)	S1/S1
						ML5963	(+)	S1/S1
COROLLA Liftback (_E11_)	9.98 → 11.01					ML6087	(-)	S1/S1
						ML5963	(+)	S1/S1
COROLLA (_E12_)	1.02 → 2.07					ML5485		S1/U
COROLLA Estate (_E12_)	1.02 → 2.07					ML5486		S1/S1
COROLLA Verso (_E12_)	1.02 → 5.04					ML5641		S1/S1
COROLLA Verso (ZER_, ZZE12_, R1_)	3.04 → 3.09					ML5666		U/U

IQ

IQ (_J1_)	1.09 →					ML6133		S1/S1
-----------	--------	--	--	--	--	---------------	--	-------

LAND CRUISER

LAND CRUISER 100 (FZJ1_, UZJ1_)	1.98 → 8.07		ML6324		T1/T1			
LAND CRUISER 200 (GRJ2_, UZJ2_, VDJ2_)	8.07 →		ML6345⁰		T1/T1			
LAND CRUISER (LJ12_, KZJ12_, TRJ12_, KDJ12_, GRJ12_)	9.02 → 7.09		ML6325		T1/T1			

PRIUS

PRIUS Hatchback (_W2_)	8.03 → 3.09					ML5917		S1/S1
PRIUS (_W3_)	4.09 →					ML6134		S1/S3

VERSO

VERSO (_R2_)	4.09 →					ML6135		S1/S3
VERSO S (_P12_)	11.10 → 10.16					ML6135		S1/S3

YARIS

YARIS (_P1_)	4.99 → 11.05					ML5821		S1/U
YARIS (_P9_)	1.05 →					ML5777		U/U
YARIS (_P13_)	12.10 →					ML6184		9/43

UAZ**PATRIOT**

PATRIOT	7.04 →					ML6283⁰		U/U
---------	--------	--	--	--	--	---------------------------	--	-----



VAUXHALL

AGILA

AGILA Mk I (A) 2.00 → 3.08		<table border="1" style="width: 100%; border-collapse: collapse;"> <tr> <td style="width: 15%;">ML5088</td> <td style="width: 60%;">→ 12.01</td> <td style="width: 25%;">E2/E3</td> </tr> <tr> <td>ML5089</td> <td>→ 12.01</td> <td>E2/E3</td> </tr> <tr> <td>ML6044</td> <td>1.02 →</td> <td>S1/S1</td> </tr> </table>	ML5088	→ 12.01	E2/E3	ML5089	→ 12.01	E2/E3	ML6044	1.02 →	S1/S1
ML5088	→ 12.01	E2/E3									
ML5089	→ 12.01	E2/E3									
ML6044	1.02 →	S1/S1									

ANTARA

ANTARA (J26, H26) 8.06 →	ML6046	U/U
---------------------------	---------------	-----

ASTRA

ASTRA Mk II Hatchback 9.84 → 8.91		<table border="1" style="width: 100%; border-collapse: collapse;"> <tr> <td style="width: 15%;">ML5528</td> <td style="width: 60%;">Ch. n° → J2502492 (+) </td> <td style="width: 25%;">M/O</td> </tr> <tr> <td>ML5835</td> <td>Ch. n° -JE100000 → J2502492 (-) </td> <td>M/O</td> </tr> <tr> <td>ML5407</td> <td>Ch. n° -JE100001, -J2502492 →</td> <td>U/U</td> </tr> </table>	ML5528	Ch. n° → J2502492 (+)	M/O	ML5835	Ch. n° -JE100000 → J2502492 (-)	M/O	ML5407	Ch. n° -JE100001, -J2502492 →	U/U
ML5528	Ch. n° → J2502492 (+)	M/O									
ML5835	Ch. n° -JE100000 → J2502492 (-)	M/O									
ML5407	Ch. n° -JE100001, -J2502492 →	U/U									
ASTRA Mk II Estate 9.84 → 8.91		<table border="1" style="width: 100%; border-collapse: collapse;"> <tr> <td>ML5528</td> <td>Ch. n° → J2502492 (+) </td> <td>M/O</td> </tr> <tr> <td>ML5835</td> <td>Ch. n° -JE100000 → J2502492 (-) </td> <td>M/O</td> </tr> <tr> <td>ML5407</td> <td>Ch. n° -JE100001, -J2502492 →</td> <td>U/U</td> </tr> </table>	ML5528	Ch. n° → J2502492 (+)	M/O	ML5835	Ch. n° -JE100000 → J2502492 (-)	M/O	ML5407	Ch. n° -JE100001, -J2502492 →	U/U
ML5528	Ch. n° → J2502492 (+)	M/O									
ML5835	Ch. n° -JE100000 → J2502492 (-)	M/O									
ML5407	Ch. n° -JE100001, -J2502492 →	U/U									
ASTRA Mk III (F) Hatchback 9.91 → 2.98		ML5077 U/C1									
ASTRA Mk III (F) Estate 3.91 → 2.98		ML5156 (-) , (+)									
ASTRA Mk III (F) Convertible 3.93 → 3.01		ML5125 (+)									
ASTRA Mk IV (G) Hatchback 2.98 → 5.05		ML6047 S1/S1									
ASTRA Mk IV (G) Estate 2.98 → 5.05		ML5166 U/C1									
ASTRA Mk IV (G) Convertible 3.01 → 10.05		ML5167 (+) , 3									
ASTRA Mk V (H) Sport Hatch 2.05 → 11.10	ML5720	U/U									
ASTRA Mk V (H) Hatchback 1.04 → 9.09	ML5720	U/U									
ASTRA Mk V (H) Estate 8.04 → 10.10	ML5720	U/U									
ASTRA TwinTop Mk V (H) 9.05 → 11.10	ML5720	U/U									
ASTRA Mk VI (J) 12.09 →		ML5723 S1/S1									
ASTRA Mk VI (J) Saloon 6.12 →		ML6122 P/P									
ASTRA Mk VI (J) Estate 10.10 →		ML6335⁰ S1/S3									
ASTRA GTC Mk VI (J) 10.11 →		ML6178 7b/44									
		ML6240 U/C1									

ASTRAVAN

ASTRAVAN Mk IV (G) 8.98 → 8.06		ML5138 U/U
ASTRAVAN Mk V (H) 3.05 →	ML5720	U/U

CALIBRA

CALIBRA 6.90 → 7.97		ML5367 U/U
----------------------	--	-------------------

**CARLTON**

CARLTON Mk II Estate	9.77 → 8.86
CARLTON Mk III	9.86 → 3.94
CARLTON Mk III Estate	9.86 → 3.94

ML5398		U/U
ML5366	Ch. n° → N1145948	U/U
ML5365	Ch. n° N1145949 →	U/U
ML5408		U/U

CASCADA

CASCADA Convertible	2.13 →
---------------------	--------

--	--	--	--

ML6286		S1/S3
---------------	--	-------

CAVALIER

CAVALIER Mk II Hatchback	9.81 → 8.88
CAVALIER Mk III Hatchback	9.88 → 11.95

ML5391		U/U
ML5390	(-)	U/U
ML5032		U/U

COMBO

COMBO TOUR Mk II (C) (F25)	9.01 → 2.12
COMBO Mk II (C) Box Body / Estate (F25)	9.01 → 2.12

ML6057		U/C1
ML6057		U/C1

CORSA

CORSA Mk I (B)	12.92 → 9.00
CORSA Mk II (C) (W5L, F08)	8.00 → 10.06
CORSA Mk III (D) (L_8)	7.06 → 8.14
CORSA Mk IV (E)	8.14 →

ML5242	(-) , 3	U/U
ML5054	(+) , 3	U/U
ML5144	5	U/U
ML5827	3	U/U
ML5807	5	U/U
ML5827	3	U/U
ML5807	5	U/U
ML6362⁰	3	P/P
ML6361⁰	5	P/P

CORSAVAN

CORSAVAN Mk I (B)	1.94 → 9.00
CORSAVAN Mk II (C)	9.00 → 6.06
CORSAVAN Mk IV (E)	10.14 →

ML5242	(-) , 3	U/U
ML5054	(+) , 3	U/U
ML5144	5	U/U
ML5827	3	U/U
ML5807	5	U/U
ML6362⁰	3	P/P

FRONTERA

FRONTERA Mk II (B)	10.98 → 10.04
--------------------	---------------

--	--	--	--

ML5825		S1/S1
ML6043		U/U

INSIGNIA

INSIGNIA	7.08 →
INSIGNIA Saloon	7.08 →
INSIGNIA Estate	7.08 →

ML6049		U/U
ML6049		U/U
ML6049		U/U

ML6051		U/U
ML6053	(-)	U/C1
ML6055	(+)	U/U

VAUXHALL



MERIVA

MERIVA Mk I (A)	1.03 → 6.10					ML5119		U/U
-----------------	-------------	--	--	--	--	--------	--	-----

NOVA

NOVA Hatchback	5.83 → 3.93					ML5585	(-)	O/O
----------------	-------------	--	--	--	--	--------	-----	-----

OMEGA

OMEGA (B)	1.94 → 7.03					ML5210		U/U
-----------	-------------	--	--	--	--	--------	--	-----

OMEGA (B) Estate	2.94 → 6.03					ML5103		U/U
------------------	-------------	--	--	--	--	--------	--	-----

SENATOR

SENATOR Mk II (B)	9.87 → 9.93					ML5366	Ch. n° → N1145948	U/U
-------------------	-------------	--	--	--	--	--------	-------------------	-----

						ML5365	Ch. n° N1145949 →	U/U
--	--	--	--	--	--	--------	-------------------	-----

SIGNUM

SIGNUM	3.03 → 10.08		ML5345		U/U	ML5817		P/U
--------	--------------	--	--------	--	-----	--------	--	-----

SINTRA

SINTRA	11.96 → 4.99					ML5515		U/U
--------	--------------	--	--	--	--	--------	--	-----

TIGRA

TIGRA Mk I (F07)	7.94 → 12.00					ML5369		U/U
------------------	--------------	--	--	--	--	--------	--	-----

VECTRA

VECTRA (B)	8.95 → 3.02		ML5085		U/U	ML5179	Ch. n° X1000001 →	S1/S1
------------	-------------	--	--------	--	-----	--------	-------------------	-------

VECTRA (B) Hatchback	8.95 → 7.03		ML5085		U/U	ML5082	Ch. n° -W7999999 → -W5999999 5	U/U
----------------------	-------------	--	--------	--	-----	--------	-----------------------------------	-----

VECTRA (B) Estate	8.95 → 3.02		ML5085		U/U	ML5257	Ch. n° X1000001- →	U/U
-------------------	-------------	--	--------	--	-----	--------	--------------------	-----

VECTRA Mk II (C) GTS	8.02 → 7.08		ML5345		U/U	ML5424		U/S1
----------------------	-------------	--	--------	--	-----	--------	--	------

VECTRA Mk II (C)	1.00 → 10.08		ML5345		U/U	ML5773		U/U
------------------	--------------	--	--------	--	-----	--------	--	-----

VECTRA Mk II (C) Estate	10.03 → 7.08		ML5345		U/U	ML5341		U/U
-------------------------	--------------	--	--------	--	-----	--------	--	-----

			ML5345		U/U	ML5346		U/U
--	--	--	--------	--	-----	--------	--	-----

VIVARO

VIVARO Box (F7)	8.01 → 7.14					ML5516		T1/T1
-----------------	-------------	--	--	--	--	--------	--	-------

ZAFIRA

ZAFIRA Mk I (A) (F75)	11.98 → 8.05					ML5137		U/U
-----------------------	--------------	--	--	--	--	--------	--	-----

ZAFIRA Mk II (B) (M75)	4.05 → 11.14					ML5722		U/U
------------------------	--------------	--	--	--	--	--------	--	-----

VOLVO

440

440 K (445)	8.88 → 12.96					ML5571		T1/T1
-------------	--------------	--	--	--	--	--------	--	-------

460

460 L (464)	9.88 → 7.96					ML5571		T1/T1
-------------	-------------	--	--	--	--	--------	--	-------

**480**

480 E	4.86 → 7.96					ML5509			T1/T1
-------	-------------	--	--	--	--	---------------	--	--	-------

740

740 (744)	4.83 → 8.92					ML5906			I/H
740 Kombi (745)	8.85 → 8.92					ML5312			U/U

760

760 Kombi (704, 765)	1.82 → 7.92					ML5312			U/U
----------------------	-------------	--	--	--	--	---------------	--	--	-----

780

780	4.86 → 7.90					ML6090			I/H
-----	-------------	--	--	--	--	---------------	--	--	-----

850

850 (LS)	6.91 → 12.96					ML5840			I/H
850 Estate (LW)	8.92 → 10.97					ML5529			O/M

940

940 (944)	8.90 → 12.94					ML5347			U/U
940 Kombi (945)	8.90 → 7.95					ML5312			U/U
940 II (944)	8.94 → 12.98					ML5347			U/U
940 II Estate (945)	8.94 → 10.98					ML5312			U/U

960

960 (964)	8.90 → 7.94					ML5347			U/U
960 Kombi (965)	8.90 → 7.94					ML5312			U/U
960 II (964)	7.94 → 12.96					ML5347			U/U
960 II Estate (965)	8.94 → 12.96					ML5312			U/U

340-360

340-360 (343, 345)	8.75 → 7.91					ML5642	(+)		T1/T1
340-360 Saloon (344)	8.82 → 7.91					ML5642	(+)		T1/T1

C30

C30	10.06 → 12.12		ML5726		U/U	ML5907			S1/S3
-----	---------------	--	---------------	--	-----	---------------	--	--	-------

C70

C70 I Coupe	3.97 → 9.02					ML5487			S1/S1
C70 II Convertible	3.06 → 6.13		ML5726		U/U				

S40

S40 I (VS)	7.95 → 12.03		ML5368		S1/S1	ML5154			U/U
S40 II (MS)	1.04 → 12.12		ML5726		U/U	ML5488			S1/S1

S60

S60 I	7.00 → 4.10		ML5643		S1/S1	ML5481			S1/S1
S60 II	4.10 →		ML6222		U/C1	ML6246			U/C1

VOLVO



	STD				STD			
	SPECIAL							

S70

S70 (LS)	11.96 → 11.00				ML5909		I/U
----------	---------------	--	--	--	---------------	--	-----

S80

S80 I (TS, XY)	5.98 → 7.06	ML5643		S1/S1	ML5489		S1/S1
S80 II (AS)	3.06 →	ML5663		U/U	ML5490	(+)	S1/S1
					ML6091		U/U

S90

S90	11.96 → 10.98				ML5348		U/U
-----	---------------	--	--	--	---------------	--	-----

V40

V40 Estate (VW)	7.95 → 6.04	ML5368		S1/S1	ML5184		S1/P
V40 Hatchback	3.12 →	ML6254		P/C1			

V50

V50 (MW)	4.04 → 12.12	ML5726		U/U	ML5500		S1/S1
----------	--------------	---------------	--	-----	---------------	--	-------

V60

V60	9.10 →	ML6222		U/C1	ML6223		U/C1
-----	--------	---------------	--	------	---------------	--	------

V70

V70 I (LV)	11.96 → 11.00				ML5529	→ 8.00	O/M
V70 II (SW)	3.00 → 10.08	ML5643		S1/S1	ML5685		M/O
V70 III (BW)	8.07 →	ML5663		U/U	ML6092	(-)	O/M
					ML6094	(+)	S2/S2

V90

V90 Estate	11.96 → 12.98				ML5312		U/U
------------	---------------	--	--	--	---------------	--	-----

XC60

XC60	5.08 →	ML6136		U/C1	ML6224		O/O
------	--------	---------------	--	------	---------------	--	-----

XC70

XC70 CROSS COUNTRY	11.97 → 9.02	ML5643		S1/S1	ML5685		M/O
XC70 II	4.07 →	ML5663		U/U	ML5529	→ 8.00	O/M

XC90

XC90 I	10.02 → 9.14	ML5361		U/U	ML5427		S1/U
--------	--------------	---------------	--	-----	---------------	--	------

VW

AMAROK

AMAROK (2H_, S1B)	9.10 →				ML6328		U/C1
					ML6329	(=)	S1/S3
AMAROK Platform/Chassis (S1B)	9.11 →				ML6328		U/C1
					ML6329	(=)	S1/S3



VW



BEETLE

BEETLE Convertible (5C7, 5C8)	12.11 →				ML6326		U/C1
-------------------------------	---------	--	--	--	---------------	--	------

BORA

BORA (1J2)	10.98 → 5.05	ML5261		S1/U	ML5193 (+)		U/U
BORA Estate (1J6)	5.99 → 5.05	ML5261		S1/U	ML5135		U/U
					ML5132		S1/U

CADDY

CADDY I (14)	8.82 → 7.92				ML5572		Y1/U
CADDY III Estate (2KB, 2KJ, 2CB, 2CJ)	3.04 → 5.15	ML5736	→ 8.10	S1/U	ML5750		U/U
		ML6152	8.10 →	S1/P			
CADDY III Box (2KA, 2KH, 2CA, 2CH)	3.04 → 5.15	ML5736	→ 8.10	S1/U	ML5750		U/U
		ML6152	8.10 →	S1/P			

CORRADO

CORRADO (53I)	9.88 → 12.95				ML5573		U/D
---------------	--------------	--	--	--	---------------	--	-----

EOS

EOS (1F7, 1F8)	3.06 → 8.15	ML5738		P/U	ML5752		U/U
----------------	-------------	---------------	--	-----	---------------	--	-----

FOX

FOX (5Z1, 5Z3)	10.03 →				ML5796		S1/U
----------------	---------	--	--	--	---------------	--	------

GOLF

GOLF I (17)	4.74 → 2.84				ML5073		Y1/X1
GOLF II (19E, 1G1)	8.83 → 12.92				ML5574	Ch. n° → 19E780000	U/D
					ML5038	Ch. n° 19E780001 →	U/U
GOLF III (1H1)	10.91 → 9.97				ML5049		U/C1
GOLF III Variant (1H5)	7.93 → 4.99				ML5191		U/U
GOLF III Cabriolet (1E7)	7.93 → 5.98	ML5264		S1/U	ML5675		U/U
GOLF IV (1J1)	8.97 → 6.05	ML5261		S1/U	ML5132		S1/U
GOLF IV Variant (1J5)	5.99 → 6.06	ML5261		S1/U	ML5132		S1/U
GOLF IV Cabriolet (1E7)	6.98 → 6.02	ML5264		S1/U	ML5675		U/U
GOLF V (1K1)	10.03 → 2.09	ML5735		P/U	ML5742		S1/U
GOLF V Variant (1K5)	6.07 → 7.09	ML5735		P/U	ML5754		U/P
GOLF VI (5K1)	10.08 → 11.13	ML5648		P/U	ML5653		S1/U
GOLF VI Variant (AJ5)	7.09 → 7.13	ML5648		P/U	ML5754		U/P
GOLF VII (5G1, BE1)	8.12 →	ML6221		P/C1	ML6220		S1/C1
GOLF VII Estate (BA5)	4.13 →	ML6221		P/C1	ML6327		U/C1
GOLF ALLTRACK (BA5)	12.14 →	ML6221		P/C1	ML6327		U/C1
GOLF SPORTSVAN (AM1)	2.14 →	ML6221		P/C1			
GOLF PLUS (5M1, 521)	1.05 → 12.13				ML5792		U/P



JETTA

JETTA III (1K2)	8.05 → 10.10
JETTA IV (162, 163)	4.10 →

ML5735		P/U

ML5751		T1/T1
ML6247		U/C1

LOAD

LOAD UP	12.14 →
---------	---------

--	--	--

ML6189		7b/44
---------------	--	-------

LUPO

LUPO (6X1, 6E1)	9.98 → 7.05
-----------------	-------------

ML5287	GTI-FSI-TDI	S1/U
ML5195	Ch. n° → 6X1049577, 6E1010000	S1/U
ML5339	Ch. n° 6X1049578 →	S1/U

ML5261		S1/U
ML5199	GTI-FSI-TDI	S1/U

MULTIVAN

MULTIVAN V (7HM, 7HN, 7HF, 7EF, 7EM, 7EN)	4.03 →
---	--------

--	--	--

ML5576		U/U
---------------	--	-----

NEW BEETLE

NEW BEETLE (9C1, 1C1)	1.98 → 9.10
NEW BEETLE Convertible (1Y7)	9.02 → 10.10

ML5393		U/U
ML5393		U/U

ML5325		U/U
ML5791		S1/U

PASSAT

PASSAT Variant (3A5, 35I)	2.88 → 5.97
PASSAT (3B2)	8.96 → 11.00
PASSAT Estate (3B5)	6.97 → 11.00
PASSAT (3B3)	11.00 → 5.05
PASSAT Variant (3B6)	10.00 → 8.05
PASSAT (3C2)	3.05 → 11.10
PASSAT Variant (3C5)	8.05 → 10.11
PASSAT CC (357)	5.08 → 1.12
PASSAT (362)	8.10 → 12.14
PASSAT Variant (365)	8.10 → 12.14
PASSAT ALLTRACK (365)	1.12 → 12.14
PASSAT (3G2)	8.14 →
PASSAT Variant (3G5)	8.14 →
PASSAT ALLTRACK (3G5)	5.15 →

ML5266		U/C1
ML5266		U/C1
ML5266		U/C1
ML5266		U/C1
ML5829		P/U
ML5829		P/U
ML6096		P/U
ML6185		13/44
ML6185		13/44
ML6185		13/44
ML6365⁰		P/C1
ML6365⁰		P/C1
ML6365⁰		P/C1

ML5123		S1/S1
ML5135		U/U
ML5193	(+)	U/U
ML5185		S1/U
ML5439		U/U
ML5132		S1/U
ML5830		U/P
ML5831		U/S1
ML6186		7b/13
ML6187		7b/44
ML6187		7b/44
ML6357⁰		P/C1
ML6357⁰		P/C1

PHAETON

PHAETON (3D_)	4.02 → 3.16
---------------	-------------

ML6097		S1/S1
---------------	--	-------

ML6099	(+)	S1/U
ML6098	(+)	S1/U

POLO

POLO (86C, 80)	10.81 → 9.94
POLO Box (86CF)	8.92 → 7.94
POLO (6N1)	10.94 → 10.99

ML5178	8.90 →	U/U
ML5644	→ 4.86	T1/D
ML5177	5.86 → 7.90	U/U
ML5178	8.90 →	U/U
ML5145		U/C1



VW

MONROE	STD				STD						
	SPECIAL				SPECIAL						
POLO CLASSIC (6KV2) 11.95 → 7.02									ML5259		U/U
POLO Variant (6KV5) 5.97 → 9.01									ML5100		S1/S1
POLO (6N2) 10.99 → 9.01					ML5265				ML5145		U/C1
POLO (9N_) 10.01 → 1.12					ML5491				ML5194 (-)		S1/U
POLO Saloon (9A4) 9.02 →									ML5196 (+)		S1/U
POLO (6R, 6C) 6.09 →									ML5748		S1/U
POLO Van (6R) Box Body / Hatchback 1.14 →									ML5849		U/U
									ML5849		U/U

SCIROCCO

SCIROCCO (53) 2.74 → 7.80									ML5677		Y1/T1
SCIROCCO (53B) 8.80 → 7.92									ML5677		Y1/T1
SCIROCCO (137, 138) 5.08 →									ML6100		U/U

SHARAN

SHARAN (7M8, 7M9, 7M6) 9.95 → 3.10					ML5480			S1/S1	ML5127		U/U
SHARAN (7N1, 7N2) 5.10 →					ML6217			U/C1	ML6216		S1/K

TIGUAN

TIGUAN (5N_) 9.07 →									ML5838		P/P
----------------------	--	--	--	--	--	--	--	--	--------	--	-----

TOUAREG

TOUAREG (7LA, 7L6, 7L7) 10.02 → 5.10					ML5357			U/U	ML5793		S1/S1
---------------------------------------	--	--	--	--	--------	--	--	-----	--------	--	-------

TOURAN

TOURAN (1T1, 1T2) 2.03 → 5.10					ML5736			S1/U	ML5743		U/P
TOURAN (1T3) 5.10 → 5.15					ML5736			S1/U	ML6188		7b/25

TRANSPORTER

TRANSPORTER III Bus 5.79 → 7.92									ML5106		U/D
TRANSPORTER III Box 5.79 → 7.92					ML5832			U/P	ML5645	M308-Hydrolift	Y1/U
TRANSPORTER IV Bus (70XB, 70XC, 7DB, 7DW, 7DK) 9.90 → 4.03					ML6101			S1/S1	ML5106		U/D
TRANSPORTER IV Box (70XA) 7.90 → 4.03					ML6101			S1/S1	ML5246	Ch. n° → 70N151781, 70N151781 (-) , F1(N):660	U/U
									ML5245	Ch. n° → 70N151781, 70N151781 (+) , F1(N):750	U/U
									ML5105	Ch. n° → 70N151781, 70N151781 (+) , (+) Heat insulating glass	U/U
									ML5247	Ch. n° → 70N151781, 70N151781 F1(N):830	U/U
									ML5249	Ch. n° 70N151781, 70N151781 → (-) , F1(N):710	P/P
									ML5251	Ch. n° 70N151781, 70N151781 → (-) , Trim Version	P/P
									ML5118	Ch. n° 70N151781, 70N151781 → (+)	P/P
									ML5250	Ch. n° 70N151781, 70N151781 → (+) , (+) Heat insulating glass	P/P
									ML5248	Ch. n° 70N151781, 70N151781 → M308 - Hydrolift	U/U
									ML5246	Ch. n° → 70N151781 (-) , F1(N):660	U/U
									ML5245	Ch. n° → 70N151781 (+) , F1(N):750	U/U
									ML5105	Ch. n° → 70N151781 (+) , (+) Heat insulating glass	U/U

VW



	STD				STD			
	SPECIAL							
TRANSPORTER IV Platform/ Chassis (70XD)	7.90 → 4.03	ML6101		S1/S1				
TRANSPORTER V Bus (7HB, 7HJ, 7EB, 7EJ, 7EF, 7EG, 7HF, 7EC)	4.03 →	ML5832		U/P	ML5833	F1(N):1080		U/P
					ML5575	F1(N):970		U/P
TRANSPORTER V Box (7HA, 7HH, 7EA, 7EH)	4.03 →	ML5832		U/P	ML5833	F1(N):1080		U/P
					ML5575	F1(N):970		U/P

UP

UP	8.11 →				ML6189			7b/44
----	--------	--	--	--	--------	--	--	-------

VENTO

VENTO (1H2)	11.91 → 9.98				ML5226			U/S1
-------------	--------------	--	--	--	--------	--	--	------

ZASTAVA

101

101 (1100)	6.73 → 12.93				ML5003			U/U
------------	--------------	--	--	--	--------	--	--	-----

YUGO

YUGO	4.80 → 6.95				ML5028			U/U
YUGO FLORIDA	10.88 → 11.08				ML5008			Y1/X1
					ML5097	Poly		U/U

ZAZ

TAVRIA

TAVRIA (1102)	1.89 → 12.07				ML5035	1102		U/U
					ML5115	1103		U/U
					ML5072	1105		U/U
					ML5116	11055		U/U



A series of horizontal lines spanning the width of the page, providing a space for writing.

MONROE® MAX-LIFT® REPLACED & OBSOLETE PARTS

Ref	Ref
ML5001	-
ML5002	-
ML5007	-
ML5012	-
ML5027	-
ML5029	-
ML5033	ML5255
ML5046	-
ML5047	-
ML5050	-
ML5052	-
ML5053	-
ML5058	-
ML5059	-
ML5060	-
ML5062	-
ML5070	-
ML5071	-





Ref	Ref
ML5075	-
ML5083	-
ML5084	-
ML5090	-
ML5112	-
ML5117	-
ML5150	ML5152
ML5174	ML5161
ML5186	ML5188
ML5187	ML5188
ML5201	ML5200
ML5203	ML5503
ML5204	ML5503
ML5220	ML5221
ML5304	-
ML5326	ML5202
ML5423	ML5433
ML5451	ML5235

Ref	Ref
ML5468	ML6173
ML5479	-
ML5497	ML5499
ML5498	ML5499
ML5520	ML5590
ML5601	ML5603
ML5602	ML5605
ML5604	ML5605
ML5614	ML5539
ML5615	-
ML5841	ML5850
ML5853	ML5698
ML5854	-
ML5858	ML5277
ML5859	-
ML5865	-
ML5874	-
ML5875	-

Ref	Ref
ML5876	-
ML5877	-
ML5878	-
ML5879	-
ML5880	-
ML5881	-
ML5882	-
ML5883	-
ML5884	-
ML5885	-
ML5886	ML5078
ML5887	ML5078
ML5896	-
ML5897	-
ML5898	-
ML5899	-
ML5901	-
ML5902	-

Ref	Ref
ML5903	-
ML5904	-
ML5905	-
ML5908	ML5909
ML5913	-
ML5914	-
ML5915	ML5790
ML5916	ML5852
ML5993	ML6169

MONROE® MAX-LIFT® NUMERICAL LISTING

Ref.		Ref.		Ref.		Ref.	
ML5003	FIAT	ML5085	CHEVROLET	ML5152	RENAULT	ML5232	FORD
ML5004	ZASTAVA		OPEL	ML5153	RENAULT	ML5233	FORD
ML5005	RENAULT		VAUXHALL	ML5154	HYUNDAI	ML5234	AUDI
ML5006	ŠKODA	ML5086	FIAT		VOLVO	ML5235	BMW
ML5008	FIAT		NISSAN	ML5156	OPEL	ML5236	BMW
ML5009	ZASTAVA	ML5087	DAEWOO		VAUXHALL	ML5237	BMW
ML5010	FIAT	ML5088	OPEL	ML5157	HYUNDAI	ML5238	AUDI
	CITROËN		SUZUKI	ML5158	RENAULT	ML5239	AUDI
	FIAT		VAUXHALL	ML5159	LANCIA	ML5240	AUDI
ML5011	SEAT	ML5089	OPEL	ML5160	PEUGEOT	ML5241	RENAULT
	ABARTH		SUZUKI	ML5161	FORD	ML5242	OPEL
	CITROËN		VAUXHALL	ML5162	CITROËN		VAUXHALL
	FIAT	ML5091	SUZUKI	ML5163	BMW	ML5243	OPEL
	SEAT	ML5092	SUZUKI	ML5164	FIAT	ML5244	OPEL
ML5013	FIAT	ML5093	RENAULT	ML5165	FIAT	ML5245	VW
ML5014	FIAT	ML5094	RENAULT	ML5166	OPEL	ML5246	VW
ML5015	FIAT	ML5095	DAEWOO		VAUXHALL	ML5247	VW
ML5016	FIAT	ML5096	DAEWOO	ML5167	OPEL	ML5248	VW
	SEAT	ML5097	ZASTAVA		VAUXHALL	ML5249	VW
ML5017	AUTOBIANCHI	ML5098	CHEVROLET	ML5168	FORD	ML5250	VW
	LANCIA		DAEWOO	ML5169	FORD	ML5251	VW
ML5018	FIAT	ML5099	ŠKODA	ML5170	BMW	ML5252	FORD
ML5019	CITROËN	ML5100	SEAT	ML5171	FORD	ML5253	FORD
ML5020	PEUGEOT		VW	ML5172	FORD	ML5254	RENAULT
ML5021	RENAULT	ML5101	FIAT	ML5173	FORD	ML5255	CITROËN
ML5022	SEAT	ML5102	MERCEDES-BENZ	ML5175	ŠKODA	ML5256	RENAULT
ML5023	FORD	ML5103	OPEL	ML5176	FORD	ML5257	OPEL
ML5024	LADA		VAUXHALL	ML5177	NISSAN		VAUXHALL
ML5025	LADA	ML5104	AUDI		VW	ML5258	OPEL
ML5026	ŠKODA	ML5105	VW	ML5178	VW	ML5259	SEAT
ML5028	ZASTAVA	ML5106	VW	ML5179	OPEL		VW
ML5030	FIAT	ML5107	LADA		VAUXHALL	ML5260	BMW
ML5031	DAEWOO	ML5108	LADA	ML5180	PEUGEOT	ML5261	AUDI
	OPEL	ML5109	FORD	ML5181	SEAT		VW
ML5032	OPEL	ML5110	FORD	ML5182	RENAULT	ML5262	CITROËN
	VAUXHALL	ML5111	AUDI	ML5183	PEUGEOT	ML5263	BMW
ML5034	FIAT	ML5113	CITROËN	ML5184	VOLVO	ML5264	VW
ML5035	ZAZ		PEUGEOT	ML5185	VW	ML5265	VW
ML5036	ŠKODA	ML5114	LADA	ML5188	MERCEDES-BENZ	ML5266	AUDI
ML5037	ŠKODA	ML5115	ZAZ	ML5189	RENAULT		VW
ML5038	FIAT	ML5116	ZAZ	ML5190	RENAULT	ML5267	PEUGEOT
	VW	ML5118	VW	ML5191	VW	ML5268	PEUGEOT
ML5039	FIAT	ML5119	OPEL	ML5192	HONDA	ML5269	AUDI
ML5040	FIAT		VAUXHALL		ROVER	ML5270	CITROËN
ML5041	AUSTIN	ML5120	OPEL	ML5193	SEAT	ML5271	ALFA ROMEO
	FIAT	ML5121	TOYOTA		VW	ML5272	ALFA ROMEO
	MG	ML5122	HONDA	ML5194	VW	ML5273	ALFA ROMEO
	ROVER	ML5123	VW	ML5195	SEAT	ML5274	ALFA ROMEO
ML5042	FIAT	ML5124	SEAT		VW	ML5275	AUDI
ML5043	FIAT	ML5125	OPEL	ML5196	VW	ML5276	AUDI
ML5044	ŠKODA		VAUXHALL	ML5197	AUDI	ML5277	AUDI
ML5045	ŠKODA	ML5126	FORD	ML5198	AUDI	ML5278	MITSUBISHI
ML5048	ŠKODA	ML5127	FORD	ML5199	VW	ML5279	RENAULT
ML5049	VW		SEAT	ML5200	FORD	ML5280	FIAT
ML5051	DAEWOO	ML5128	RENAULT	ML5201 ¹	FORD	ML5281	FIAT
ML5054	OPEL	ML5129	CITROËN	ML5202	PEUGEOT	ML5282	FIAT
	VAUXHALL	ML5130	RENAULT	ML5205	FORD	ML5283	FIAT
ML5055	FIAT	ML5131	RENAULT	ML5206	FORD	ML5284	SEAT
ML5056	INNOCENTI	ML5132	VW	ML5207	FORD	ML5285	FORD
ML5057	ŠKODA	ML5133	PEUGEOT	ML5208	ROVER	ML5286	FORD
ML5061	ŠKODA	ML5134	PEUGEOT	ML5209	ROVER	ML5287	VW
ML5063	SEAT	ML5135	AUDI	ML5210	OPEL	ML5288	FORD
ML5064	FIAT		ŠKODA		VAUXHALL	ML5289	FORD
	INNOCENTI	ML5136	VW	ML5211	SEAT	ML5290	FORD
ML5065	FIAT		FORD	ML5212	RENAULT	ML5291	FORD
ML5066	FIAT	ML5137	OPEL	ML5213	BMW	ML5292	FORD
ML5067	PEUGEOT		VAUXHALL	ML5214	HONDA	ML5293	FORD
ML5068	FIAT	ML5138	OPEL	ML5215	ALFA ROMEO	ML5294	FORD
ML5069	FIAT		VAUXHALL	ML5216	ALFA ROMEO	ML5295	FORD
ML5072	ZAZ	ML5139	LANCIA	ML5217	ŠKODA	ML5296	HYUNDAI
ML5073	VW	ML5140	SEAT	ML5218	ŠKODA	ML5297	HYUNDAI
ML5074	FIAT	ML5141	FORD	ML5219	ŠKODA	ML5298	LADA
ML5076	FORD	ML5142	FORD	ML5221	ŠKODA	ML5299	LADA
ML5077	OPEL	ML5143	FORD	ML5222	ALFA ROMEO	ML5300	LANCIA
	VAUXHALL	ML5144	OPEL	ML5223	AUDI	ML5301	LANCIA
ML5078	FIAT		VAUXHALL	ML5224	FORD	ML5302	LANCIA
	OPEL	ML5145	VW	ML5225	SEAT	ML5303	LANCIA
	SUZUKI	ML5146	PEUGEOT	ML5226	VW	ML5305	LANCIA
ML5079	FIAT	ML5147	FORD	ML5227	AUDI	ML5306	LAND ROVER
ML5080	FORD		MAZDA	ML5228	RENAULT	ML5307	MERCEDES-BENZ
ML5081	FIAT	ML5148	PEUGEOT	ML5229	RENAULT	ML5308	MERCEDES-BENZ
ML5082	OPEL	ML5149	CITROËN	ML5230	RENAULT	ML5309	MERCEDES-BENZ
	VAUXHALL	ML5151	CITROËN	ML5231	FORD		

MONROE® MAX-LIFT® NUMERICAL LISTING

Ref.



ML5310 RENAULT
 ML5311 PEUGEOT
 ML5312 VOLVO
 ML5313 RENAULT
 ML5314 RENAULT
 ML5315 RENAULT
 ML5316 PEUGEOT
 ML5317 NISSAN
 ML5318 NISSAN
 ML5319 PEUGEOT
 ML5320 RENAULT
 ML5321 NISSAN
 ML5322 NISSAN
 ML5323 PEUGEOT
 ML5324 NISSAN
 ML5325 VW
 ML5327 RENAULT
 ML5328 MERCEDES-BENZ
 ML5329 MERCEDES-BENZ
 ML5330 FORD
 ML5331 RENAULT
 ML5332 FORD
 ML5333 AUDI
 ML5334 DAEWOO
 SSANGYONG
 ML5335 ALFA ROMEO
 ML5336 BMW
 ML5337 RENAULT
 ML5338 ROVER
 ML5339 VW
 ML5340 PEUGEOT
 ML5341 OPEL
 VAUXHALL
 ML5342 SEAT
 ML5343 PEUGEOT
 ML5344 CITROËN
 PEUGEOT
 ML5345 OPEL
 VAUXHALL
 ML5346 OPEL
 VAUXHALL
 ML5347 VOLVO
 ML5348 VOLVO
 ML5349 SAAB
 ML5350 SAAB
 ML5351 RENAULT
 ML5352 NISSAN
 ML5353 MITSUBISHI
 ML5354 MITSUBISHI
 ML5355 DAEWOO
 SSANGYONG
 ML5356 DAEWOO
 SSANGYONG
 VW
 ML5357 PEUGEOT
 ML5358 ROVER
 ML5359 NISSAN
 ML5360 VOLVO
 ML5361 AUSTIN
 ML5362 ROVER
 ML5363 PEUGEOT
 ML5364 PEUGEOT
 ML5365 OPEL
 VAUXHALL
 ML5366 OPEL
 VAUXHALL
 ML5367 OPEL
 VAUXHALL
 ML5368 VOLVO
 ML5369 OPEL
 VAUXHALL
 ML5370 AUDI
 ML5371 HONDA
 ML5372 RENAULT
 ML5373 FORD
 ML5374 FORD
 ML5375 SAAB
 ML5376 AUDI
 ML5377 FIAT
 ML5378 HYUNDAI
 ML5379 HYUNDAI
 ML5380 HYUNDAI
 ML5381 HYUNDAI

Ref.



ML5382 HYUNDAI
 ML5383 RENAULT
 ML5384 ROVER
 ML5385 AUDI
 ML5386 AUDI
 SEAT
 ML5387 FIAT
 ML5388 FORD
 ML5389 FIAT
 ML5390 OPEL
 VAUXHALL
 ML5391 CITROËN
 OPEL
 VAUXHALL
 ALFA ROMEO
 ML5392 VW
 ML5393 ROVER
 ML5394 OPEL
 ML5395 HONDA
 ML5396 SAAB
 ML5397 OPEL
 VAUXHALL
 ML5399 FORD
 ML5400 SAAB
 ML5401 SAAB
 ML5402 SAAB
 ML5403 MAZDA
 ML5404 FIAT
 ML5405 HONDA
 ML5406 MINI
 ML5407 OPEL
 VAUXHALL
 ML5408 OPEL
 VAUXHALL
 ML5409 NISSAN
 ML5410 MG
 ROVER
 ML5411 MG
 ROVER
 ML5412 MG
 ROVER
 ML5413 NISSAN
 ML5414 ALFA ROMEO
 ML5415 FORD
 ML5416 FORD
 ML5417 AUDI
 ML5418 AUDI
 ML5419 ALFA ROMEO
 ML5420 AUDI
 ML5421 BMW
 ML5422 BMW
 ML5424 OPEL
 VAUXHALL
 ML5425 PEUGEOT
 ML5426 PEUGEOT
 ML5427 VOLVO
 ML5428 AUDI
 ML5429 FORD
 ML5430 CITROËN
 ML5431 FORD
 ML5432 PEUGEOT
 ML5433 NISSAN
 ML5434 MG
 ROVER
 ML5435 CITROËN
 ML5436 BMW
 ML5437 AUDI
 ML5438 MERCEDES-BENZ
 ML5439 ŠKODA
 VW
 ML5440 RENAULT
 ML5441 BMW
 ML5442 ALFA ROMEO
 ML5443 FIAT
 ML5444 BMW
 ML5445 BMW
 ML5446 CHEVROLET
 ML5447 HONDA
 ML5448 FIAT
 ML5449 AUDI
 DACIA
 ML5450 BMW
 ML5452 CITROËN

Ref.



ML5453 CITROËN
 ML5454 CITROËN
 ML5455 CITROËN
 ML5456 CITROËN
 ML5457 CITROËN
 ML5458 FIAT
 ML5459 AUDI
 ML5460 AUDI
 ML5461 CITROËN
 ML5462 FIAT
 ML5463 FORD
 ML5464 FORD
 ML5465 FORD
 ML5466 FORD
 ML5467 FORD
 ML5469 PEUGEOT
 ML5470 PEUGEOT
 ML5471 PEUGEOT
 ML5472 RENAULT
 ML5473 RENAULT
 ML5474 RENAULT
 ML5475 RENAULT
 ML5476 RENAULT
 ML5477 RENAULT
 ML5478 ROVER
 SEAT
 VW
 ML5481 VOLVO
 ML5482 LANCIA
 ML5483 LANCIA
 ML5484 LANCIA
 ML5485 TOYOTA
 ML5486 TOYOTA
 ML5487 VOLVO
 ML5488 VOLVO
 ML5489 VOLVO
 ML5490 VOLVO
 ML5491 VW
 ML5492 SUZUKI
 ML5493 SUZUKI
 ML5494 SAAB
 ML5495 SAAB
 ML5496 LANCIA
 SAAB
 ML5499 SAAB
 ML5500 VOLVO
 ML5501 ABARTH
 SEAT
 ML5502 FORD
 ML5503 CITROËN
 ML5504 CITROËN
 ML5505 CITROËN
 ML5506 CITROËN
 ML5507 DAEWOO
 ML5508 HONDA
 ML5509 VOLVO
 ML5510 AUDI
 ML5511 AUDI
 ML5512 AUDI
 ML5513 DAEWOO
 ML5514 FORD
 ML5515 OPEL
 VAUXHALL
 ML5516 NISSAN
 OPEL
 VAUXHALL
 ML5517 PEUGEOT
 ML5518 RENAULT
 ML5519 RENAULT
 ML5521 BMW
 ML5522 BMW
 ML5523 BMW
 ML5524 NISSAN
 ML5525 NISSAN
 ML5526 RENAULT
 ML5527 OPEL
 ML5528 OPEL
 VAUXHALL
 ML5529 VOLVO
 ML5530 MERCEDES-BENZ
 ML5531 ALFA ROMEO
 ML5532 ALFA ROMEO

Ref.



ML5533 AUDI
 ML5534 AUDI
 ML5535 BMW
 ML5536 CITROËN
 ML5537 FIAT
 ML5538 FIAT
 ML5539 FORD
 ML5540 LANCIA
 ML5541 LANCIA
 ML5542 MAZDA
 ML5543 MERCEDES-BENZ
 ML5544 RENAULT
 ML5545 RENAULT
 ML5546 RENAULT
 ML5547 RENAULT
 ML5548 RENAULT
 ML5549 RENAULT
 ML5550 RENAULT
 ML5551 RENAULT
 ML5552 RENAULT
 ML5553 RENAULT
 ML5554 RENAULT
 ML5555 RENAULT
 ML5556 SAAB
 ML5557 SAAB
 ML5558 SAAB
 ML5559 MERCEDES-BENZ
 ML5560 MERCEDES-BENZ
 ML5561 LANCIA
 ML5562 BMW
 ML5563 BMW
 ML5564 MINI
 ML5565 BMW
 ML5566 BMW
 ML5567 HONDA
 ML5568 HONDA
 ML5569 HYUNDAI
 ML5570 HYUNDAI
 ML5571 VOLVO
 ML5572 VW
 ML5573 VW
 ML5574 VW
 ML5575 VW
 ML5576 VW
 ML5577 MERCEDES-BENZ
 ML5578 MITSUBISHI
 ML5579 NISSAN
 ML5580 NISSAN
 ML5581 NISSAN
 ML5582 NISSAN
 ML5583 PEUGEOT
 ML5584 SEAT
 ML5585 OPEL
 VAUXHALL
 ML5586 OPEL
 ML5587 MITSUBISHI
 ML5588 NISSAN
 ML5589 SUZUKI
 ML5590 BMW
 ML5591 JEEP
 ML5592 TOYOTA
 ML5593 AUDI
 ML5594 PORSCHE
 ML5595 PORSCHE
 ML5596 BMW
 ML5597 ALFA ROMEO
 ML5598 AUTOBIANCHI
 ML5599 BMW
 ML5600 BMW
 ML5603 CITROËN
 ML5605 CITROËN
 ML5606 CITROËN
 ML5607 CITROËN
 ML5608 ALFA ROMEO
 ML5609 CITROËN
 ML5611 FORD
 ML5612 FORD
 ML5613 SAAB
 ML5615¹ HONDA
 ML5616 HYUNDAI
 ML5617 LANCIA
 ML5618 LANCIA

MONROE® MAX-LIFT® NUMERICAL LISTING

Ref.



ML5619 LANCIA
 ML5620 MERCEDES-BENZ
 ML5621 MERCEDES-BENZ
 ML5622 MG
 ML5623 MG
 ROVER
 ML5624 NISSAN
 ML5625 PEUGEOT
 ML5626 PEUGEOT
 ML5627 PEUGEOT
 ML5628 PEUGEOT
 ML5629 RENAULT
 ML5630 RENAULT
 ML5631 RENAULT
 ML5632 RENAULT
 ML5633 RENAULT
 ML5634 ROVER
 ML5635 SAAB
 ML5636 SAAB
 ML5637 SAAB
 ML5638 SAAB
 ML5639 SEAT
 ML5640 SMART
 ML5641 TOYOTA
 ML5642 VOLVO
 ML5643 VOLVO
 ML5644 VW
 ML5645 VW
 ML5646 PORSCHE
 ML5647 TOYOTA
 ML5648 VW
 ML5649 LAND ROVER
 ML5650 FORD
 ML5651 FORD
 ML5652 CITROËN
 ML5653 VW
 ML5654 FORD
 ML5655 ALFA ROMEO
 ML5656 RENAULT
 ML5657 RENAULT
 ML5658 BMW
 ML5659 BMW
 ML5660 HYUNDAI
 ML5661 MITSUBISHI
 ML5662 MITSUBISHI
 ML5663 VOLVO
 ML5664 FORD
 ML5665 ŠKODA
 ML5666 TOYOTA
 ML5667 ŠKODA
 ML5668 CITROËN
 ML5669 OPEL
 VAUXHALL
 ML5670 BMW
 ML5671 BMW
 ML5672 NISSAN
 ML5673 MERCEDES-BENZ
 ML5674 MERCEDES-BENZ
 ML5675 VW
 ML5676 PORSCHE
 ML5677 VW
 ML5678 AUDI
 ML5679 AUDI
 ML5680 MERCEDES-BENZ
 ML5681 ŠKODA
 ML5682 ŠKODA
 ML5683 MAZDA
 ML5684 MAZDA
 ML5685 VOLVO
 ML5686 RENAULT
 ML5687 CITROËN
 PEUGEOT
 ML5688 BMW
 ML5689 BMW
 NISSAN
 ML5690 BMW
 ML5691 BMW
 ML5692 BMW
 ML5693 BMW
 ML5694 BMW
 ML5695 BMW
 ML5696 ALFA ROMEO

Ref.



ML5697 ALFA ROMEO
 ML5698 ALFA ROMEO
 ML5699 TOYOTA
 ML5700 NISSAN
 ML5701 NISSAN
 ML5702 FIAT
 LANCIA
 ML5703 LANCIA
 ML5704 LANCIA
 FORD
 ML5705 KIA
 ML5706 KIA
 ML5707 KIA
 ML5708 KIA
 ML5709 KIA
 ML5710 KIA
 ML5711 KIA
 ML5712 KIA
 ML5713 KIA
 ML5714 CHEVROLET
 DAEWOO
 ML5715 MERCEDES-BENZ
 ML5716 MERCEDES-BENZ
 ML5717 MERCEDES-BENZ
 ML5718 MERCEDES-BENZ
 ML5719 MERCEDES-BENZ
 ML5720 OPEL
 VAUXHALL
 ML5721 OPEL
 ML5722 OPEL
 VAUXHALL
 ML5723 KIA
 OPEL
 VAUXHALL
 ML5724 RENAULT
 ML5725 RENAULT
 ML5726 VOLVO
 ML5727 PEUGEOT
 ML5728 PEUGEOT
 ML5729 PEUGEOT
 ML5730 PEUGEOT
 ML5731 PEUGEOT
 ML5732 PEUGEOT
 ML5733 PEUGEOT
 ML5734 PEUGEOT
 ML5735 VW
 ML5736 VW
 ML5737 AUDI
 ML5738 VW
 ML5739 AUDI
 ML5740 AUDI
 ML5741 AUDI
 ML5742 VW
 ML5743 VW
 ML5744 AUDI
 ML5745 AUDI
 SEAT
 ML5746 AUDI
 ML5747 AUDI
 ML5748 VW
 ML5749 AUDI
 ML5750 VW
 ML5751 VW
 ML5752 NISSAN
 VW
 ML5753 AUDI
 ML5754 VW
 ML5755 CITROËN
 ML5756 CITROËN
 ML5757 MITSUBISHI
 ML5758 HYUNDAI
 ML5759 HYUNDAI
 ML5760 HYUNDAI
 ML5761 HYUNDAI
 ML5762 HYUNDAI
 ML5763 MAZDA
 ML5764 MAZDA
 ML5765 MAZDA
 ML5766 SAAB
 ML5767 SEAT
 ML5768 ŠKODA
 ML5769 BMW
 ML5770 FORD
 ML5771 FORD

Ref.



ML5772 FORD
 ML5773 OPEL
 VAUXHALL
 ML5774 AUDI
 ML5775 ABARTH
 FIAT
 ML5776 CITROËN
 MITSUBISHI
 PEUGEOT
 TOYOTA
 ML5777 TOYOTA
 ML5778 SEAT
 ML5779 FIAT
 SUZUKI
 ML5780 SUZUKI
 ML5781 NISSAN
 ML5782 CITROËN
 ML5783 CITROËN
 ML5784 FIAT
 ML5785 FIAT
 ML5786 FORD
 ML5787 HONDA
 ML5788 PEUGEOT
 ML5789 RENAULT
 ML5790 SAAB
 ML5791 VW
 ML5792 VW
 ML5793 VW
 ML5794 CHEVROLET
 DAEWOO
 ML5795 FIAT
 ML5796 VW
 ML5797 FORD
 ML5798 MERCEDES-BENZ
 ML5799 MERCEDES-BENZ
 ML5800 MERCEDES-BENZ
 ML5801 MERCEDES-BENZ
 ML5802 MERCEDES-BENZ
 ML5803 PORSCHE
 ML5804 PORSCHE
 ML5805 OPEL
 VAUXHALL
 ML5806 MERCEDES-BENZ
 ML5807 OPEL
 VAUXHALL
 ML5808 MERCEDES-BENZ
 ML5809 NISSAN
 ML5810 MAZDA
 ML5811 MERCEDES-BENZ
 ML5812 RENAULT
 ML5813 MERCEDES-BENZ
 ML5814 HYUNDAI
 ML5815 ROVER
 ML5816 HYUNDAI
 ML5817 OPEL
 VAUXHALL
 MERCEDES-BENZ
 ML5818 MERCEDES-BENZ
 ML5819 SUBARU
 ML5820 SUBARU
 ML5821 TOYOTA
 ML5822 CITROËN
 ML5823 KIA
 ML5824 CITROËN
 ML5825 OPEL
 VAUXHALL
 ML5826 RENAULT
 ML5827 OPEL
 VAUXHALL
 RENAULT
 ML5828 RENAULT
 ML5829 VW
 ML5830 VW
 ML5831 VW
 ML5832 JAGUAR
 VW
 ML5833 VW
 ML5834 OPEL
 ML5835 OPEL
 VAUXHALL
 ML5836 HONDA
 ML5837 NISSAN
 ML5838 VW
 ML5839 KIA
 ML5840 VOLVO
 ML5842 MAZDA

Ref.



ML5843 MAZDA
 ML5844 AUDI
 ML5845 SEAT
 ML5846 PORSCHE
 ML5847 MAZDA
 ML5848 MAZDA
 ML5849 VW
 ML5850 SEAT
 ML5851 PEUGEOT
 ML5852 SAAB
 ML5855 ALFA ROMEO
 ML5856 AUDI
 ML5857 AUDI
 ML5860 BMW
 ML5861 BMW
 ML5862 CITROËN
 ML5864 DACIA
 RENAULT
 ML5866 HONDA
 ML5867 HYUNDAI
 ML5868 HYUNDAI
 ML5869 HYUNDAI
 ML5870 LAND ROVER
 ML5871 LAND ROVER
 ML5872 LAND ROVER
 ML5873 MAZDA
 ML5888 OPEL
 VAUXHALL
 ML5889 PEUGEOT
 ML5890 NISSAN
 ML5891 RENAULT
 ML5892 RENAULT
 ML5893 RENAULT
 ML5894 RENAULT
 ML5895 SMART
 ML5900 TOYOTA
 ML5906 VOLVO
 ML5907 VOLVO
 ML5909 VOLVO
 ML5910 HONDA
 ML5911 HONDA
 ML5912 KIA
 ML5917 TOYOTA
 ML5918 AUDI
 ML5919 ALFA ROMEO
 ML5920 ALFA ROMEO
 ML5921 ALFA ROMEO
 ML5922 AUDI
 ML5923 AUDI
 ML5924 AUDI
 ML5925 AUDI
 ML5926 AUDI
 ML5927 AUDI
 ML5928 AUDI
 ML5929 AUDI
 ML5930 AUDI
 ML5932 BMW
 ML5934 BMW
 ML5936 BMW
 ML5938 BMW
 ML5939 CHEVROLET
 ML5940 CHEVROLET
 ML5941 CHEVROLET
 DAEWOO
 ML5943 CHEVROLET
 ML5944 CHRYSLER
 ML5945 CHRYSLER
 ML5946 CHRYSLER
 ML5947 CHRYSLER
 ML5948 CITROËN
 PEUGEOT
 ML5950 CITROËN
 FIAT
 PEUGEOT
 ML5954 CITROËN
 PEUGEOT
 ML5956 CITROËN
 PEUGEOT
 ML5958 CITROËN
 ML5959 CITROËN
 ML5961 CITROËN
 ML5962 CITROËN

NUMERICAL LISTING

MONROE® MAX-LIFT® NUMERICAL LISTING

Ref.



ML5963 CITROËN
 ML5967 TOYOTA
 ML5968 CITROËN
 FIAT
 PEUGEOT
 ML5973 FIAT
 ML5974 FIAT
 ML5975 ABARTH
 FIAT
 ML5976 FIAT
 ML5977 FORD
 ML5978 FORD
 ML5979 FORD
 ML5980 FORD
 ML5981 FORD
 ML5982 HONDA
 ML5983 HONDA
 ML5984 HONDA
 ML5985 HONDA
 ML5986 HYUNDAI
 ML5987 HYUNDAI
 ML5989 HYUNDAI
 ML5990 HYUNDAI
 ML5991 HYUNDAI
 ML5992 HYUNDAI
 ML5994 HYUNDAI
 ML5995 JAGUAR
 ML5996 JAGUAR
 ML5997 JEEP
 ML5998 JEEP
 ML5999 JEEP
 ML6000 JEEP
 ML6001 JEEP
 ML6002 KIA
 ML6003 LANCIA
 ML6004 LAND ROVER
 ML6005 LAND ROVER
 ML6006 LAND ROVER
 ML6008 LEXUS
 ML6009 LEXUS
 ML6011 MAZDA
 ML6012 MAZDA
 ML6013 MAZDA
 ML6014 MAZDA
 ML6015 MAZDA
 ML6016 MERCEDES-BENZ
 ML6017 MERCEDES-BENZ
 ML6019 MERCEDES-BENZ
 ML6020 MERCEDES-BENZ
 ML6021 MERCEDES-BENZ
 ML6022 MERCEDES-BENZ
 ML6023 MERCEDES-BENZ
 ML6024 MERCEDES-BENZ
 ML6025 MERCEDES-BENZ
 ML6026 MERCEDES-BENZ
 ML6027 MERCEDES-BENZ
 ML6028 MERCEDES-BENZ
 ML6029 MERCEDES-BENZ
 ML6030 MERCEDES-BENZ
 ML6031 MERCEDES-BENZ
 ML6032 MERCEDES-BENZ
 ML6033 MG
 ROVER
 ML6035 MINI
 ML6036 MINI
 ML6037 MINI
 ML6038 MITSUBISHI
 ML6039 MITSUBISHI
 ML6040 NISSAN
 ML6041 NISSAN
 ML6042 NISSAN
 ML6043 OPEL
 VAUXHALL
 ML6044 OPEL
 SUZUKI
 VAUXHALL
 ML6046 OPEL
 VAUXHALL
 ML6047 OPEL
 VAUXHALL
 ML6049 OPEL
 VAUXHALL

Ref.



ML6051 OPEL
 VAUXHALL
 ML6053 OPEL
 VAUXHALL
 ML6055 OPEL
 VAUXHALL
 ML6057 OPEL
 VAUXHALL
 ML6058 PEUGEOT
 ML6060 PEUGEOT
 ML6061 PEUGEOT
 ML6062 PORSCHE
 ML6063 RENAULT
 ML6065 PORSCHE
 ML6066 PORSCHE
 ML6067 PORSCHE
 ML6068 PORSCHE
 ML6069 PORSCHE
 ML6070 RENAULT
 ML6071 RENAULT
 ML6072 RENAULT
 ML6073 RENAULT
 ML6074 RENAULT
 ML6075 RENAULT
 ML6076 SAAB
 ML6079 ŠKODA
 ML6080 ŠKODA
 ML6081 ŠKODA
 ML6082 SMART
 ML6083 SMART
 ML6084 DAIHATSU
 SUZUKI
 ML6085 SUZUKI
 ML6086 SUZUKI
 ML6087 TOYOTA
 ML6089 TOYOTA
 ML6090 VOLVO
 ML6091 VOLVO
 ML6092 VOLVO
 ML6094 VOLVO
 ML6096 VW
 ML6097 VW
 ML6098 VW
 ML6099 VW
 ML6100 VW
 ML6101 VW
 ML6102 AUDI
 ML6103 AUDI
 ML6104 AUDI
 ML6105 AUDI
 ML6106 AUDI
 ML6107 BMW
 ML6108 BMW
 ML6109 BMW
 ML6110 BMW
 ML6111 BMW
 ML6112 CHRYSLER
 ML6113 CHRYSLER
 ML6114 CITROËN
 ML6115 CITROËN
 ML6116 JEEP
 ML6117 JEEP
 ML6118 KIA
 ML6119 KIA
 ML6120 MAZDA
 ML6121 NISSAN
 ML6122 OPEL
 VAUXHALL
 ML6123 PEUGEOT
 ML6124 PEUGEOT
 ML6125 RENAULT
 ML6126 RENAULT
 ML6127 RENAULT
 ML6128 RENAULT
 ML6129 SEAT
 ML6130 ŠKODA
 ML6131 SUZUKI
 ML6132 TOYOTA
 ML6133 TOYOTA
 ML6134 TOYOTA
 ML6135 TOYOTA
 ML6136 VOLVO

Ref.



ML6137 ALFA ROMEO
 ML6138 ALFA ROMEO
 ML6140 CHEVROLET
 ML6141 BMW
 ML6142 BMW
 ML6143 CITROËN
 ML6144 HYUNDAI
 ML6145 LEXUS
 ML6146 OPEL
 VAUXHALL
 ML6147 PORSCHE
 ML6148 ROVER
 ML6149 ALFA ROMEO
 ML6150 AUDI
 ML6151 TOYOTA
 ML6152 VW
 ML6153 AUDI
 ML6154 AUDI
 ML6155 AUDI
 ML6156 AUDI
 ML6157 AUDI
 ML6158 BMW
 ML6159 BMW
 ML6160 BMW
 ML6161 BMW
 ML6162 BMW
 ML6163 BMW
 ML6164 CITROËN
 ML6165 FORD
 ML6166 FORD
 ML6167 FORD
 ML6168 FORD
 ML6169 HYUNDAI
 ML6170 KIA
 ML6171 KIA
 ML6172 MERCEDES-BENZ
 ML6173 MERCEDES-BENZ
 ML6176 MINI
 ML6177 MINI
 ML6178 OPEL
 VAUXHALL
 ML6179 OPEL
 VAUXHALL
 ML6180 PEUGEOT
 ML6181 PEUGEOT
 ML6183 SEAT
 ML6184 TOYOTA
 ML6185 VW
 ML6186 VW
 ML6187 VW
 ML6188 VW
 ML6189 VW
 ML6190 ALFA ROMEO
 ML6191 ALFA ROMEO
 ML6192 AUDI
 ML6193 AUDI
 ML6194 BMW
 ML6195 CHRYSLER
 ML6196 CITROËN
 ML6197 CITROËN
 ML6198 DACIA
 ML6199 DACIA
 ML6200 DACIA
 ML6201 FIAT
 OPEL
 ML6202 FORD
 ML6203 HYUNDAI
 ML6204 JAGUAR
 ML6205 JAGUAR
 ML6206 KIA
 ML6207 LAND ROVER
 ML6209 LAND ROVER
 ML6210 MERCEDES-BENZ
 ML6211 NISSAN
 ML6213 PEUGEOT
 ML6214 RENAULT
 ML6215 RENAULT
 ML6216 SEAT
 VW
 ML6217 SEAT
 VW
 ML6218 ŠKODA
 ML6219 SUZUKI

Ref.



ML6220 VW
 ML6221 VW
 ML6222 VOLVO
 ML6223 VOLVO
 ML6224 VOLVO
 ML6225 AUDI
 ML6226 AUDI
 ML6227 BMW
 ML6228 CHEVROLET
 ML6229 CHEVROLET
 ML6230 DODGE
 FIAT
 ML6231 GAZ
 ML6232 HYUNDAI
 ML6233 JAGUAR
 ML6234 KIA
 ML6235 KIA
 ML6236 KIA
 ML6237 MAZDA
 ML6238 MAZDA
 ML6239 OPEL
 ML6240 OPEL
 VAUXHALL
 ML6241 PORSCHE
 ML6242 RENAULT
 ML6243 RENAULT
 ML6244 RENAULT
 ML6245 SEAT
 ML6246 VOLVO
 ML6247 VW
 ML6248 CITROËN
 ML6249 CITROËN
 ML6250 DACIA
 ML6251 PORSCHE
 ML6253 PEUGEOT
 ML6254 VOLVO
 ML6255 HYUNDAI
ML6269⁰ NISSAN
ML6272⁰ LADA
ML6273⁰ LADA
ML6276 FIAT
ML6277 FIAT
ML6278⁰ LADA
ML6279⁰ LADA
ML6280 PEUGEOT
ML6281 FIAT
ML6283⁰ UAZ
ML6284 AUDI
ML6285⁰ NISSAN
ML6286 OPEL
 VAUXHALL
ML6287 FORD
ML6288 ŠKODA
ML6289 ŠKODA
ML6290 AUDI
ML6291 AUDI
ML6292 AUDI
ML6294 CHEVROLET
ML6295 CHEVROLET
ML6296 CHEVROLET
ML6297 FORD
ML6298 FORD
ML6299 FORD
ML6300 JEEP
ML6301 JEEP
ML6302 JEEP
ML6303 KIA
ML6304⁰ LADA
ML6305 LAND ROVER
ML6306 MAZDA
ML6307 MAZDA
ML6308 MAZDA
ML6309 MERCEDES-BENZ
ML6310 MERCEDES-BENZ
ML6311 MERCEDES-BENZ
ML6312 MERCEDES-BENZ
ML6313 MERCEDES-BENZ
ML6314 MINI
ML6315 MITSUBISHI
ML6316 NISSAN
ML6317 NISSAN

MONROE® MAX-LIFT® NUMERICAL LISTING

Ref.



ML6318 NISSAN
ML6319 PORSCHE
ML6320 SEAT
ML6321 SEAT
ML6322 ŠKODA
ML6323 TOYOTA
ML6324 TOYOTA
ML6325 TOYOTA
ML6326 VW
ML6327 VW
ML6328 VW
ML6329 VW
ML6330⁰ FORD
ML6331⁰ LEXUS
ML6332⁰ ŠKODA
ML6333⁰ BMW
ML6335⁰ OPEL
 VAUXHALL
ML6336⁰ SUZUKI
ML6337⁰ MAZDA
ML6338⁰ MAZDA
ML6339⁰ RENAULT
ML6340⁰ NISSAN
ML6341⁰ KIA
ML6342⁰ KIA
ML6343⁰ KIA
ML6344⁰ FIAT
ML6345⁰ TOYOTA
ML6346⁰ AUDI
ML6347⁰ AUDI
ML6348⁰ BMW
ML6349⁰ AUDI
ML6350⁰ BMW
ML6351⁰ BMW
ML6352⁰ CITROËN
ML6353⁰ CITROËN
 PEUGEOT
ML6354⁰ FORD
ML6355⁰ BMW
ML6356⁰ FORD
ML6357⁰ VW
ML6358⁰ FORD
ML6359⁰ TOYOTA
ML6360⁰ PEUGEOT
ML6361⁰ OPEL
 VAUXHALL
ML6362⁰ OPEL
 VAUXHALL
ML6363⁰ NISSAN
ML6364⁰ NISSAN
ML6365⁰ VW
ML6366⁰ FORD
ML6367⁰ KIA
ML6368⁰ TOYOTA

Ref.



Ref.





Ref.



NUMERICAL LISTING

MONROE® MAX-LIFT® OE CROSS REFERENCE LIST

	OE N°:	Ref.
ALFA ROMEO		
ALFA ROMEO	46739202	ML5696
ALFA ROMEO	46771551	ML5222
ALFA ROMEO	50508010	ML6149
ALFA ROMEO	50508060	ML5855
ALFA ROMEO	50508706	ML5655
ALFA ROMEO	50509830	ML6190
ALFA ROMEO	50515442	ML5655
ALFA ROMEO	50519970	ML6191
ALFA ROMEO	60505771	ML5597
ALFA ROMEO	60540532	ML5531
ALFA ROMEO	60558222	ML5919
ALFA ROMEO	60564112	ML5608
ALFA ROMEO	60566147	ML5274
ALFA ROMEO	60567794	ML5335
ALFA ROMEO	60577413	ML6138
ALFA ROMEO	60583192	ML5532
ALFA ROMEO	60591762	ML5273
ALFA ROMEO	60594694	ML6137
ALFA ROMEO	60594694	ML6138
ALFA ROMEO	60604174	ML5608
ALFA ROMEO	60604823	ML5271
ALFA ROMEO	60612565	ML5272
ALFA ROMEO	60622167	ML6137
ALFA ROMEO	60622424	ML5419
ALFA ROMEO	60651067	ML5215
ALFA ROMEO	60654724	ML5392
ALFA ROMEO	60657685	ML5216
ALFA ROMEO	60658924	ML5414
ALFA ROMEO	60664833	ML5442
ALFA ROMEO	60680087	ML5698
ALFA ROMEO	60683933	ML6149
ALFA ROMEO	60688574	ML5697
ALFA ROMEO	60689182	ML6138
ALFA ROMEO	60694168	ML5921
ALFA ROMEO	60694616	ML5920
ALFA ROMEO	605582220	ML5919
ALFA ROMEO	606589240	ML5414

	OE N°:	Ref.
AUDI		
AUDI	441827551	ML5120
AUDI	893823360	ML5593
AUDI	893827552	ML5417
AUDI	3B0823239A	ML5266
AUDI	3B0823359	ML5266
AUDI	3B0823359B	ML5266
AUDI	443823359B	ML5420
AUDI	4A0823359B	ML5385
AUDI	4A0823359C	ML5678
AUDI	4A5827551	ML5428
AUDI	4A5827552	ML5111
AUDI	4A9827552	ML5418
AUDI	4B0823359A	ML5266
AUDI	4B0823359B	ML5266
AUDI	4B0823359C	ML5266
AUDI	4B5827552A	ML5234
AUDI	4B5827552C	ML5234
AUDI	4B5827552D	ML5234
AUDI	4B5827552F	ML5223
AUDI	4B5827552G	ML5223
AUDI	4B9827552A	ML5238
AUDI	4B9827552C	ML5239
AUDI	4B9827552D	ML5510
AUDI	4B9827552E	ML5239
AUDI	4B9827552G	ML5240
AUDI	4B9827552H	ML5510
AUDI	4B9827552J	ML5511
AUDI	4B9827552L	ML5239
AUDI	4B9827552M	ML5239
AUDI	4B9827552N	ML5512

	OE N°:	Ref.
AUDI	4D0823359F	ML5276
AUDI	4D0823551B	ML5275
AUDI	4D0827551A	ML5275
AUDI	4D0827551B	ML5275
AUDI	4E0823359C	ML5924
AUDI	4E0827551A	ML5316
AUDI	4E0827551B	ML5925
AUDI	4E0827552B	ML5926
AUDI	4E0827552C	ML5926
AUDI	4E827551C	ML5925
AUDI	4F0823359	ML5737
AUDI	4F0823359A	ML5737
AUDI	4F5827552	ML5744
AUDI	4F5827552B	ML5744
AUDI	4F5827552B	ML6104
AUDI	4F9827552B	ML5746
AUDI	4F9827552C	ML5746
AUDI	4F9827552D	ML5746
AUDI	4F9827552E	ML5746
AUDI	4G8823359A	ML6193
AUDI	4G9827552	ML6226
AUDI	4G9827552A	ML6192
AUDI	4H0823359A	ML6106
AUDI	4H0823359B	ML6106
AUDI	4H0823359D	ML6106
AUDI	4H0827551B	ML6105
AUDI	4L0823359	ML5739
AUDI	4L0827552C	ML5774
AUDI	4L0827552F	ML5774
AUDI	4L0827552E	ML5929
AUDI	893827552A	ML5533
AUDI	895827552A	ML5534
AUDI	8A0823359B	ML6156
AUDI	8A0823360A	ML5333
AUDI	8A5827552	ML5376
AUDI	8A5827552A	ML5104
AUDI	8A9827552D	ML5437
AUDI	8D0823359	ML5679
AUDI	8D0823359A	ML5679
AUDI	8D0823359B	ML5679
AUDI	8D5827552	ML5135
AUDI	8D5827552A	ML5135
AUDI	8D5827552B	ML5135
AUDI	8D5827552C	ML5135
AUDI	8D5827552D	ML5135
AUDI	8D5827552F	ML5135
AUDI	8D9827552	ML5197
AUDI	8D9827552F	ML5198
AUDI	8D9827552H	ML5198
AUDI	8E0823359A	ML5386
AUDI	8E5827552J	ML5745
AUDI	8E5827552K	ML5745
AUDI	8E9827552E	ML5227
AUDI	8E9827552G	ML5747
AUDI	8E9827552H	ML5747
AUDI	8F0827550A	ML6103
AUDI	8G0827552C	ML5927
AUDI	8G0827552B	ML5927
AUDI	8H0823359	ML5269
AUDI	8H0827552B	ML5844
AUDI	8J0823359C	ML5740
AUDI	8J7827552	ML5930
AUDI	8J8827552	ML5753
AUDI	8K5827919	ML6225
AUDI	8K5827919A	ML6225
AUDI	8K9827552	ML5918
AUDI	8K9827552	ML5923
AUDI	8K9827552A	ML5923
AUDI	8L0823359	ML5261



	OE N°:	Ref.
AUDI	8N0823359	ML5135
AUDI	8N7827552A	ML6150
AUDI	8N7827552C	ML6150
AUDI	8N8827552	ML5277
AUDI	8N8827552A	ML5449
AUDI	8N8827552B	ML5449
AUDI	8P0823359	ML5269
AUDI	8P0823359A	ML5269
AUDI	8P0823359B	ML5269
AUDI	8P3827552A	ML5459
AUDI	8P3827552D	ML5460
AUDI	8P4827552B	ML5749
AUDI	8P7827552C	ML5922
AUDI	8P7827552D	ML5922
AUDI	8P7827552F	ML5922
AUDI	8R0823359A	ML5928
AUDI	8R0827552	ML5856
AUDI	8R0827552A	ML5857
AUDI	8S0823359	ML6349
AUDI	8S7827552A	ML6347
AUDI	8S8827552A	ML6346
AUDI	8T0823359	ML5741
AUDI	8T8827552	ML6102
AUDI	8T8827552A	ML6102
AUDI	8U0827552A	ML6157
AUDI	8U0823359B	ML6156
AUDI	8V0823359	ML6284
AUDI	8V082335903S	ML6284
AUDI	8V3827552	ML6291
AUDI	8V4827552	ML6290
AUDI	8V7827552A	ML6292
AUDI	8X0823359	ML6154
AUDI	8X3827552	ML6153
AUDI	8X4827552	ML6155
AUDI	8Z0827552A	ML5370
AUDI	8Z0827552B	ML5370
AUDI	D0823354	ML5679

AUSTIN		
AUSTIN	AFPI282	ML5041
AUSTIN	BEP6628	ML5362



AUTOBIANCHI		
AUTOBIANCHI	4480856	ML5017
AUTOBIANCHI	4484653	ML5017
AUTOBIANCHI	5970097	ML5598
AUTOBIANCHI	60617400	ML5598

BMW		
BMW	7060688	ML5691
BMW	11811869147	ML5566
BMW	11811906286	ML5596
BMW	41612990344	ML6108
BMW	41627166758	ML6141
BMW	51231868555	ML5599
BMW	51231869147	ML5600
BMW	51231906286	ML5596
BMW	51231907962	ML5599
BMW	51231908465	ML5566
BMW	51231927129	ML5599
BMW	51231944119	ML5522
BMW	51231960852	ML5421
BMW	51233400352	ML5769
BMW	51237008745	ML5562
BMW	51237016178	ML5938
BMW	51237060550	ML5689
BMW	51237070670	ML5932
BMW	51237118370	ML5563
BMW	51237148346	ML5936
BMW	51237185032	ML6142
BMW	51237191528	ML6111
BMW	51237207188	ML6333



MONROE® MAX-LIFT® OE CROSS REFERENCE LIST

	OE N°:	Ref.		OE N°:	Ref.		OE N°:	Ref.
BMW	51237210727	ML6163	CHEVROLET	95472696	ML6295	CITROEN	7552182580	ML5010
BMW	51237239233	ML6158	CHEVROLET	95962016	ML5943	CITROEN	7552182580	ML5011
BMW	51237255812	ML6160	CHEVROLET	95962017	ML5943	CITROEN	873E07	ML5435
BMW	51237300535	ML6355	CHEVROLET	96306833	ML5096	CITROEN	9556845480	ML5601
BMW	51238119558	ML5422	CHEVROLET	96306833	ML5941	CITROEN	9558825480	ML5019
BMW	51238150077	ML5441	CHEVROLET	96310381	ML5446	CITROEN	9559852680	ML5603
BMW	51238174866	ML5336	CHEVROLET	96314606	ML5098	CITROEN	9560649080	ML5452
BMW	51238202688	ML5263	CHEVROLET	96394240	ML5446	CITROEN	9563195680	ML5607
BMW	51238240596	ML5565	CHEVROLET	96474968	ML6228	CITROEN	9563598880	ML5602
BMW	51238402551	ML5688	CHEVROLET	96507773	ML5098	CITROEN	9563598980	ML5605
BMW	51241908431	ML5934	CHEVROLET	96518910	ML5098	CITROEN	9563914480	ML5457
BMW	51241934270	ML5444	CHEVROLET	96540939	ML5714	CITROEN	9602754380	ML5033
BMW	51241947096	ML5450	CHEVROLET	96548931	ML5794	CITROEN	9612212280	ML5506
BMW	51241960862	ML5170	CHEVROLET	96557538	ML5096	CITROEN	9612361280	ML5255
BMW	51242231663	ML5445	CHEVROLET	96557538	ML5941	CITROEN	9618119180	ML5149
BMW	51242264448	ML5260	CHEVROLET	96557539	ML5098	CITROEN	9629618980	ML5270
BMW	51242491349	ML5236	CHEVROLET	96563503	ML5098	CITROEN	9637509380	ML5262
BMW	51242990136	ML6109	CHEVROLET	96598008	ML5098	CITROEN	9640894580	ML5536
BMW	51243400379	ML5693	CHEVROLET	96830123	ML5940	CITROEN	9641721980	ML5453
BMW	51244212802	ML5163	CHEVROLET	96830124	ML5939	CITROEN	9647295480	ML5668
BMW	51244365788	ML5694	CHEVROLET	96984466	ML5940	CITROEN	9650854180	ML5824
BMW	51244394052	ML5694	CHRYSLER			CITROEN	9654433480	ML5756
BMW	51247008754	ML5562	CHRYSLER	04589589AA	ML5946	CITROEN	9654433580	ML5755
BMW	51247008764	ML5695	CHRYSLER	04589607AA	ML5945	CITROEN	9654433680	ML5961
BMW	51247016186	ML5861	CHRYSLER	04589626AA	ML5944	CITROEN	9654438680	ML5783
BMW	51247038248	ML5671	CHRYSLER	04724743AD	ML6113	CITROEN	9654438780	ML5958
BMW	51247060622	ML5691	CHRYSLER	04724743AE	ML6113	CITROEN	9654438880	ML5959
BMW	51247060623	ML5694	CHRYSLER	04894554AB	ML6195	CITROEN	9661815180	ML5967
BMW	51247118885	ML5671	CHRYSLER	04894554AC	ML6195	CITROEN	9676672180	ML6164
BMW	51247127875	ML5692	CHRYSLER	04894554AG	ML6195	CITROEN	9682256580	ML5652
BMW	51247129194	ML5658	CHRYSLER	05109605AC	ML5947	CITROEN	873E08	ML5455
BMW	51247129215	ML5659	CHRYSLER	4589618AA	ML6112	CITROEN	962E09	ML5129
BMW	51247191255	ML6110	CHRYSLER	4894554AE	ML6195	CITROEN	962E09	ML5435
BMW	51247200516	ML6227	CHRYSLER	4894554AF	ML6195	CITROEN	10004215A	ML6114
BMW	51247211289	ML6162	CHRYSLER	4894554AG	ML6195	CITROEN	5802A007	ML5776
BMW	51247239871	ML6159	CHRYSLER	5008938AA	ML5945	CITROEN	5802A008	ML5776
BMW	51247259763	ML6161	CHRYSLER	5064659AA	ML5946	CITROEN	689500H020	ML5687
BMW	51247263153	ML6194	CHRYSLER	G0004564	ML6113	CITROEN	7000510368C0	ML5862
BMW	51247288721	ML6227	CHRYSLER	KG004564	ML6113	CITROEN	7000510369A0	ML6196
BMW	51247295205	ML6351	CITROEN			CITROEN	8731A3	ML5454
BMW	51247295244	ML6348	CITROEN	792511	ML5270	CITROEN	8731A8	ML5430
BMW	51247304556	ML6350	CITROEN	792513	ML5262	CITROEN	8731C0	ML5149
BMW	51248110327	ML5444	CITROEN	792514	ML5461	CITROEN	8731C1	ML5456
BMW	51248146290	ML5451	CITROEN	792520	ML5822	CITROEN	8731C2	ML5203
BMW	51248149327	ML5521	CITROEN	873E03	ML5113	CITROEN	8731C3	ML5204
BMW	51248149328	ML5521	CITROEN	873196	ML5503	CITROEN	8731F1	ML5162
BMW	51248151579	ML5170	CITROEN	873197	ML5503	CITROEN	8731F5	ML5391
BMW	51248159239	ML5520	CITROEN	949901	ML5204	CITROEN	8731F6	ML5391
BMW	51248171158	ML5436	CITROEN	5429798	ML5606	CITROEN	8731F7	ML5536
BMW	51248171480	ML5523	CITROEN	5459705	ML5609	CITROEN	8731G3	ML5151
BMW	51248190688	ML5535	CITROEN	5490307	ML5609	CITROEN	8731G6	ML5344
BMW	51248206652	ML5235	CITROEN	44349891	ML6248	CITROEN	8731H2	ML6249
BMW	51248217305	ML5436	CITROEN	75521825	ML5010	CITROEN	8731H8	ML5453
BMW	51248220075	ML5163	CITROEN	95492745	ML5011	CITROEN	8731J4	ML6114
BMW	51248222913	ML5590	CITROEN	95496134	ML5019	CITROEN	8731J9	ML5824
BMW	51248227895	ML5670	CITROEN	95568454	ML5601	CITROEN	8731K1	ML5963
BMW	51248230070	ML5237	CITROEN	95568544	ML5604	CITROEN	8731K2	ML5963
BMW	51248230369	ML5521	CITROEN	95598526	ML5603	CITROEN	8731K8	ML5967
BMW	51248230370	ML5521	CITROEN	95631956	ML5607	CITROEN	8731K99639853880	ML5151
BMW	51248232873	ML5213	CITROEN	95635988	ML5602	CITROEN	8731L0	ML5687
BMW	51248251547	ML5671	CITROEN	95635988	ML5604	CITROEN	8731L9	ML5962
BMW	51248254281	ML5163	CITROEN	95635989	ML5605	CITROEN	8731N1	ML5162
BMW	51248399087	ML5860	CITROEN	96026964	ML5505	CITROEN	8731N8	ML5959
BMW	51248402405	ML5690	CITROEN	96027543	ML5033	CITROEN	8731N9	ML5783
BMW	51327200197	ML6107	CITROEN	96095456	ML5504	CITROEN	8731P0	ML5958
CHEVROLET			CITROEN	620915680	ML5430	CITROEN	8731P1	ML5961
CHEVROLET	25931219	ML6294	CITROEN	873E06	ML5129	CITROEN	8731P2	ML5756
CHEVROLET	95146515	ML6296	CITROEN	1401103980	ML5950	CITROEN	8731P4	ML5755
CHEVROLET	95470709	ML6229	CITROEN	1498071080	ML5950	CITROEN	8731P5	ML5950

MONROE® MAX-LIFT® OE CROSS REFERENCE LIST

	OE N°:	Ref.		OE N°:	Ref.		OE N°:	Ref.
CITROEN	8731Q1	ML5776	FIAT	5993542	ML5012	FIAT	82429686	ML5043
CITROEN	8731Q9	ML5950	FIAT	5993542	ML5065	FIAT	95513442	ML6201
CITROEN	8731Q9	ML5950	FIAT	7516691	ML5064	FIAT	1354844080	ML5968
CITROEN	8731R6	ML6143	FIAT	7550172	ML5039	FIAT	1489342080	ML5458
CITROEN	8731R7	ML5652	FIAT	7550938	ML5006	FIAT	9622553680	ML5283
CITROEN	8731R8	ML5956	FIAT	7587706	ML5013	FIAT	9626493880	ML5283
CITROEN	8731R9	ML5954	FIAT	7636049	ML5040	FIAT	9630698380	ML5305
CITROEN	8731S0	ML5948	FIAT	7636049	ML5050	FIAT	46720558P5	ML5973
CITROEN	8731S1	ML5862	FIAT	7636049	ML5112	FIAT	46730681C3	ML5974
CITROEN	8731T0	ML5755	FIAT	7671700	ML5014	FIAT	8731P5	ML5950
CITROEN	8731T1	ML5756	FIAT	7671700	ML5066	FIAT	8731Q9	ML5950
CITROEN	8731T9	ML6196	FIAT	7734566	ML5079	FIAT	SE14523200A	ML5016
CITROEN	8731V0	ML5968	FIAT	7769737	ML5068	FIAT	XO39401990	ML5010
CITROEN	8731V4	ML6197	FIAT	7774707	ML5069	FIAT	XO44836580	ML5016
CITROEN	8731V6	ML5954	FIAT	39401990	ML5010	FORD		
CITROEN	8731V8	ML6115	FIAT	39401990	ML5034	FORD	108277	ML5147
CITROEN	96472953808731KO	ML5782	FIAT	39462450	ML5011	FORD	1008276	ML5147
CITROEN	C101860033	ML5430	FIAT	39481770	ML5501	FORD	1009060	ML5127
DAZIA			FIAT	46304290	ML5976	FORD	1025425	ML5136
DAZIA	654712943	ML6198	FIAT	46420780	ML5078	FORD	1034930	ML5399
DAZIA	8200735264	ML5864	FIAT	46453503	ML5081	FORD	1047212	ML5127
DAZIA	654704175R	ML6250	FIAT	46514867	ML5377	FORD	1070024	ML5224
DAZIA	654712943R	ML6198	FIAT	46524047	ML5086	FORD	1071669	ML5168
DAZIA	654713274R	ML6199	FIAT	46524049	ML5086	FORD	1071732	ML5466
DAZIA	7000210536A0	ML6200	FIAT	46524051	ML5086	FORD	1072394	ML5466
DAZIA	904529943R	ML6200	FIAT	46524678	ML5165	FORD	1074368	ML5224
DAEWOO			FIAT	46530124	ML5462	FORD	1079800	ML5168
DAEWOO	90159607	ML5031	FIAT	46559850	ML5389	FORD	1088369	ML5399
DAEWOO	96298318	ML5095	FIAT	46559858	ML5389	FORD	1092108	ML5466
DAEWOO	96301822	ML5507	FIAT	46720558	ML5973	FORD	1093705	ML5168
DAEWOO	96306157	ML5087	FIAT	46730681	ML5974	FORD	1094814	ML5127
DAEWOO	96306833	ML5096	FIAT	46744596	ML5164	FORD	1114031	ML5466
DAEWOO	96306833	ML5941	FIAT	46762434	ML5443	FORD	1117046	ML5231
DAEWOO	96310381	ML5513	FIAT	46773097	ML5404	FORD	1117246	ML5502
DAEWOO	96314606	ML5098	FIAT	46783650	ML5068	FORD	1117394	ML5374
DAEWOO	96324117	ML5087	FIAT	46784590	ML5038	FORD	1117690	ML5330
DAEWOO	96324119	ML5087	FIAT	46784994	ML5280	FORD	1119688	ML5232
DAEWOO	96394240	ML5513	FIAT	46784995	ML5281	FORD	1120812	ML5330
DAEWOO	96507773	ML5098	FIAT	46792437	ML5462	FORD	1121248	ML5399
DAEWOO	96518910	ML5098	FIAT	46810696	ML5448	FORD	1124003	ML5467
DAEWOO	96540939	ML5714	FIAT	46812168	ML5387	FORD	1136483	ML5169
DAEWOO	96548931	ML5794	FIAT	46824070	ML5448	FORD	1141159	ML5206
DAEWOO	96557530	ML5095	FIAT	46826216	ML5404	FORD	1146649	ML5169
DAEWOO	96557538	ML5096	FIAT	46827091	ML5101	FORD	1150277	ML5224
DAEWOO	96557538	ML5941	FIAT	46830389	ML5702	FORD	1150279	ML5224
DAEWOO	96557539	ML5098	FIAT	46835404	ML5081	FORD	1211497	ML5289
DAEWOO	96563503	ML5098	FIAT	51709681	ML5443	FORD	1212586	ML5289
DAEWOO	96598008	ML5098	FIAT	51716995	ML5537	FORD	1218538	ML5205
DAEWOO	96601844	ML6140	FIAT	51716996	ML5538	FORD	1219986	ML5233
DAEWOO	96666915	ML6140	FIAT	51734960	ML5795	FORD	1224731	ML5207
DAEWOO	81850A70B02000	ML5051	FIAT	51736743	ML5443	FORD	1225361	ML5978
DAIHATSU	68950B1031	ML6084	FIAT	51736744	ML5443	FORD	1232189	ML5373
DAIHATSU	68960B1031	ML6084	FIAT	51736745	ML5537	FORD	1251915	ML5205
DODGE			FIAT	51736746	ML5538	FORD	1252377	ML5288
DODGE	5178293AC	ML6230	FIAT	51778432	ML5775	FORD	1252806	ML5288
DODGE	68101213AA	ML6230	FIAT	51785412	ML5785	FORD	1313218	ML5415
FIAT			FIAT	51801718	ML5975	FORD	1321021	ML5416
FIAT	21083	ML5030	FIAT	51812267	ML5784	FORD	1336159	ML5786
FIAT	132095	ML6201	FIAT	51883050	ML6277	FORD	1336230	ML5664
FIAT	4297742	ML5015	FIAT	51885487	ML6201	FORD	1349309	ML5664
FIAT	4392120	ML5011	FIAT	51895435	ML6276	FORD	1376673	ML5786
FIAT	4392129	ML5009	FIAT	51923979	ML6281	FORD	1381555	ML5770
FIAT	4392130	ML5010	FIAT	51953757	ML6277	FORD	1405189	ML5771
FIAT	4405569	ML5018	FIAT	52029616	ML6344	FORD	1434296	ML5770
FIAT	4418499	ML5042	FIAT	52031518	ML6344	FORD	1434313	ML5771
FIAT	4424045	ML5074	FIAT	71743352	ML5779	FORD	1453743	ML5979
FIAT	4483658	ML5016	FIAT	71743353	ML5779	FORD	1477988	ML5772
FIAT	5975342	ML5011	FIAT	75501720	ML5016	FORD	1484158	ML5704
FIAT	5981660	ML5041	FIAT	76063040	ML5282	FORD	1484371	ML5797

MONROE® MAX-LIFT® OE CROSS REFERENCE LIST

	OE N°:	Ref.		OE N°:	Ref.		OE N°:	Ref.
FORD	1496865	ML5704	FORD	6M21U406A10AC	ML5771	FORD	CV44S406A10AB	ML6287
FORD	1520777	ML5650	FORD	6N41L406A10AA	ML5979	FORD	CV44S406A11AB	ML6299
FORD	1523356	ML5651	FORD	7L847842104AA	ML6366	FORD	D83ABF406A10BA	ML5611
FORD	1537538	ML5654	FORD	7L847842105AA	ML6366	FORD	DS73A406A10AF	ML6356
FORD	1542413	ML5977	FORD	7S71A406A10BA	ML5797	FORD	DS73A406A10BE	ML6356
FORD	1650686	ML5285	FORD	7S71F406A10AF	ML5704	FORD	DS73A406A11AF	ML6356
FORD	1661166	ML5110	FORD	7S71N406A10AD	ML5772	FORD	DS73A406A11BE	ML6356
FORD	1666591	ML5980	FORD	81ABD406A10BA	ML5286	FORD	DS73F16C827AC	ML6358
FORD	1666983	ML5388	FORD	81ABD406A10BB	ML5285	FORD	DS73N406A10AD	ML6354
FORD	1757865	ML6202	FORD	83BBA406A10AD	ML5080	FORD	DS73N406A11AD	ML6354
FORD	1786750	ML6298	FORD	83BBA406A10BD	ML5253	FORD	V91ABL406A10AB	ML5980
FORD	1786752	ML6297	FORD	83BBA406A10CD	ML5614	FORD	V91ABL50600AA	ML5981
FORD	1790926	ML6287	FORD	83BBN406A10AD	ML5293	FORD	V97FBC406A10AB	ML5399
FORD	1790927	ML6299	FORD	83BBN406A10BB	ML5294	FORD	V97FBC406A10AC	ML5399
FORD	1860856	ML6358	FORD	84FBB406A10BB	ML5023	FORD	XS41A406A10AE	ML5224
FORD	1891212	ML6356	FORD	84FBB406A10CB	ML5465	FORD	XS41A406A10AF	ML5224
FORD	1891213	ML6356	FORD	85GBA406A10BD	ML5291	FORD	XS41F406A10AC	ML5466
FORD	1891220	ML6354	FORD	85GBA406A10CD	ML5110	FORD	XS41F406A10AD	ML5466
FORD	1891221	ML6354	FORD	85GBA406A10DD	ML5612	FORD	XS41F406A10AE	ML5466
FORD	2018961	ML6358	FORD	86ABB406A10GA	ML5463	FORD	XS41F406A10AF	ML5467
FORD	2032183	ML6356	FORD	86ABB406A10GA	ML5464	FORD	XS41N406A10AD	ML5168
FORD	2032184	ML6356	FORD	86ABB406A10HA	ML5200	FORD	XS41N406A10AE	ML5168
FORD	4346105	ML5514	FORD	86ABF406A10AA	ML5611	FORD	XS41N406A10AH	ML5169
FORD	4378216	ML5295	FORD	86ABW406A10CA	ML5286	FORD	XS41N406A10AJ	ML5169
FORD	4769673	ML6330	FORD	86BBA406A10AA	ML5539	FSO		
FORD	4770702	ML6330	FORD	86BBA406A10BA	ML5539	FSO	21273	ML5046
FORD	4795798	ML6366	FORD	86VBV406A10BA	ML5429	FSO	21331	ML5052
FORD	6151734	ML5539	FORD	86VBV406A10CA	ML5076	FSO	21333	ML5053
FORD	6186916	ML5388	FORD	88BBA406A10BAD	ML5614	FSO	21377	ML5059
FORD	6656800	ML5161	FORD	89ABB406A10HA	ML5201	FSO	21408	ML5062
FORD	6723080	ML5109	FORD	89FBB406A10A1C	ML5141	FSO	21457	ML5070
FORD	6723080	ML5173	FORD	89FBB406A10B1C	ML5142	FSO	21458	ML5071
FORD	6885988	ML5161	FORD	8A61A406A10AB	ML5651	FSO	41190	ML5007
FORD	6900217	ML5109	FORD	8V41S406A10AD	ML5654	FSO	43882	ML5027
FORD	6962811	ML5388	FORD	8V41S406A10BB	ML5650	FSO	58084	ML5045
FORD	7245797	ML5292	FORD	91ABA406A10A1D	ML5171	FSO	63397	ML5058
FORD	7300069	ML5127	FORD	91ABA406A10A1E	ML5171	FSO	77187	ML5007
FORD	9410495	ML5979	FORD	91ABA406A10C1	ML5172	FSO	77187	ML5060
FORD	51794232	ML5977	FORD	91ABA406A10C1E	ML5109	FSO	77763	ML5075
FORD	1C15V406A10AD	ML5514	FORD	91ABW406A10A1C	ML5161	FSO	1171783	ML5027
FORD	1C15V406A10EA	ML5514	FORD	91ABW406A10AF	ML5161	FSO	4369120	ML5001
FORD	1N31C406A10AB	ML5399	FORD	91ABW406A10AG	ML5161	GAZ		
FORD	1S7116C826AD	ML5330	FORD	91ABW406A10C1C	ML5173	GAZ	221711630801010	ML6231
FORD	1S71A406A10AB	ML5232	FORD	93ABA406A10B1B	ML5252	HONDA		
FORD	1S71A406A10CD	ML5233	FORD	93ABA406A10C1B	ML5109	HONDA	04741S10000	ML5447
FORD	1S71A406AD10AC	ML5231	FORD	93BBA406A10AD	ML5126	HONDA	04741S6A000	ML5615
FORD	1S71F406AD10AB	ML5502	FORD	93BBA406A10AE	ML5126	HONDA	04741SAA000	ML5911
FORD	1S71N406A10AB	ML5374	FORD	93BBA406A10BD	ML5176	HONDA	04741SEG900	ML5982
FORD	1S71N406A10AC	ML5373	FORD	93BBF406A10AB	ML5290	HONDA	047465JD000	ML5985
FORD	2N11N406A10AD	ML5289	FORD	93BBF406A10BB	ML5431	HONDA	74820S1CE01	ML5787
FORD	2S51B406A10AB	ML5205	FORD	93BBN406A10AC	ML5332	HONDA	74820S1CE018	ML5787
FORD	2S51B406A10AC	ML5205	FORD	93FBB406A10AA	ML5143	HONDA	74820S1EE01	ML5122
FORD	2S61B406A10AB	ML5206	FORD	93FBB406A10BA	ML5147	HONDA	74820S5SE01	ML5396
FORD	2S61B406A10AC	ML5207	FORD	9551B460A10AA	ML5977	HONDA	74820S6DE02	ML5371
FORD	2T14V406A10AB	ML5295	FORD	95GB16C826AB	ML5292	HONDA	74820SCA003	ML5910
FORD	3M51R406A10AB	ML5288	FORD	95VW442K08AE	ML5127	HONDA	74820SCA0031	ML5910
FORD	3S51B406A10AA	ML5978	FORD	95VW442K08AG	ML5127	HONDA	74820SH3305	ML5567
FORD	4M51A406A10AB	ML5416	FORD	95VW442K08AH	ML5127	HONDA	74820SK3E20	ML5192
FORD	4M51N406A10AA	ML5664	FORD	96FBB406A10AA	ML5147	HONDA	74820SK3E20	ML5508
FORD	4M51N406A10AB	ML5664	FORD	96FBB406A10BA	ML5147	HONDA	74820SMGE01	ML5836
FORD	5M51F406A10AA	ML5786	FORD	96GBN406A10AF	ML5388	HONDA	74820SMGE010C1	ML5836
FORD	5M51F406A10AB	ML5786	FORD	97KGB406A10AA	ML5136	HONDA	74820SMGE02	ML5836
FORD	6L8478406A10AA	ML6330	FORD	AM51R406A10AB	ML6165	HONDA	74820SMGE021M1	ML5836
FORD	6L8478406A10AB	ML6330	FORD	AM51U406A10AC	ML6168	HONDA	74820SR3003	ML5568
FORD	6L8478406A11AA	ML6330	FORD	AV11R406A10AB	ML6202	HONDA	74820ST3E01	ML5214
FORD	6L8478406A11AB	ML6330	FORD	BK21V406A10AB	ML6297	HONDA	74820ST3E02	ML5214
FORD	6M21R406A10AB	ML5770	FORD	BK21V406A10BB	ML6298	HONDA	74820ST3E02	ML5405
FORD	6M21R406A10AD	ML5770	FORD	BM51A406A10AE	ML6166	HONDA	74820ST3E51	ML5214
FORD	6M21U406A10AB	ML5771	FORD	BM51N406A10AC	ML6167	HONDA	74820ST3E52	ML5214

MONROE® MAX-LIFT® OE CROSS REFERENCE LIST

	OE N°:	Ref.
HONDA	74820ST3E52	ML5622
HONDA	74820SWAA01	ML5866
HONDA	74820TL4G01	ML5983
HONDA	74820TL4G31	ML5984
HONDA	74870S5SE01	ML5396
HONDA	74870S6DE01	ML5615
HONDA	74870S6DE02	ML5371
HONDA	74870SWAA01	ML5866
HONDA	BHE38017	ML5508
HONDA	BHE38025	ML5192
HONDA	GTS120	ML5192
HONDA	GTS122	ML5508

HYUNDAI

HYUNDAI	817712E000	ML5760
HYUNDAI	8116126000	ML5382
HYUNDAI	8177006010	ML5987
HYUNDAI	8177006011	ML5987
HYUNDAI	8177017010	ML5616
HYUNDAI	8177017030	ML5616
HYUNDAI	8177022200	ML5157
HYUNDAI	8177025220	ML5986
HYUNDAI	8177025550	ML6144
HYUNDAI	8177025560	ML6144
HYUNDAI	8177126010	ML5381
HYUNDAI	8177129221	ML5296
HYUNDAI	8177138500	ML5994
HYUNDAI	8177139501	ML5994
HYUNDAI	8178022200	ML5157
HYUNDAI	8178025210	ML5986
HYUNDAI	8178025220	ML5986
HYUNDAI	8178025220	ML6144
HYUNDAI	8178025230	ML5986
HYUNDAI	8178025230	ML6144
HYUNDAI	8717126010	ML5297
HYUNDAI	871702E020	ML5762
HYUNDAI	811602B010	ML5660
HYUNDAI	811603J000	ML5992
HYUNDAI	811612C000	ML5814
HYUNDAI	811613D000	ML5570
HYUNDAI	811613K000	ML5758
HYUNDAI	811613Z000	ML6255
HYUNDAI	811713Z000	ML6255
HYUNDAI	817700X000	ML5867
HYUNDAI	817701C000	ML5759
HYUNDAI	817701C001	ML5759
HYUNDAI	817701J000	ML5868
HYUNDAI	817701K000	ML6203
HYUNDAI	817702B001	ML5993
HYUNDAI	817702B001	ML6169
HYUNDAI	817702L200	ML5990
HYUNDAI	817703J000	ML5991
HYUNDAI	817704H030	ML5989
HYUNDAI	81770A6000	ML6232
HYUNDAI	817711Z000	ML5869
HYUNDAI	817712C010	ML5378
HYUNDAI	817712C011	ML5378
HYUNDAI	817712C020	ML5379
HYUNDAI	817712C021	ML5379
HYUNDAI	817712D210	ML5569
HYUNDAI	817712D220	ML5380
HYUNDAI	817712R000	ML5869
HYUNDAI	817713A000	ML5816
HYUNDAI	817713A001	ML5816
HYUNDAI	817713D000	ML5154
HYUNDAI	817713D001	ML5154
HYUNDAI	817713D002	ML5154
HYUNDAI	817713K000	ML5761
HYUNDAI	817801J000	ML5868
HYUNDAI	817801K000	ML6203

	OE N°:	Ref.
HYUNDAI	817802L200	ML5990
HYUNDAI	817804H030	ML5989
HYUNDAI	81780A6000	ML6232
HYUNDAI	817812R000	ML5869

INNOCENTI

INNOCENTI	7516691	ML5064
INNOCENTI	7636049	ML5040
INNOCENTI	7636049	ML5112
INNOCENTI	53471007	ML5056

JAGUAR

JAGUAR	1X4316C826AC	ML5832
JAGUAR	1X43F406A10AB	ML5996
JAGUAR	4X43N406A10AC	ML6233
JAGUAR	8X2316C826AC	ML6205
JAGUAR	8X23406A42AC	ML6204
JAGUAR	8X23406A42AD	ML6204
JAGUAR	C2S1687	ML5996
JAGUAR	C2S1927	ML5832
JAGUAR	XR82401	ML5995
JAGUAR	XR8316C826AA	ML5995
JAGUAR	XR847319	ML5995

JEEP

JEEP	55076208	ML5591
JEEP	05109514AB	ML6116
JEEP	05109514AB	ML6117
JEEP	5109514AB	ML6117
JEEP	5115226AB	ML6116
JEEP	55113632AA	ML6300
JEEP	55136764AA	ML6000
JEEP	55137022AB	ML6001
JEEP	55137022AC	ML6001
JEEP	55137023AB	ML6001
JEEP	55352896AB	ML6000
JEEP	55352897AB	ML6000
JEEP	55394472AA	ML5999
JEEP	68025357AA	ML5998
JEEP	68025359AA	ML5997
JEEP	68079364AC	ML6301
JEEP	68083884AA	ML6302
JEEP	68083885AA	ML6302

KIA



KIA	811813E000	ML5705
KIA	871703E000	ML5823
KIA	871803E000	ML5823
KIA	8177007000	ML5708
KIA	8178007000	ML5708
KIA	811813E010	ML5705
KIA	871703E010	ML5823
KIA	871803E010	ML5823
KIA	811813E011	ML5705
KIA	817713E011	ML5707
KIA	817813E011	ML5707
KIA	817713E020	ML5707
KIA	817813E020	ML5707
KIA	OK2FB62620	ML5711
KIA	OK2FB62620A	ML5711
KIA	OK2FB62620B	ML5711
KIA	OK2FB63620	ML5711
KIA	OK2FB63620A	ML5711
KIA	OK2FB63620B	ML5711
KIA	OK34C62620D	ML6303
KIA	OK34C63620D	ML6303
KIA	OK53Y56620	ML5706
KIA	OK53Y56630	ML5706
KIA	OK53Y62620	ML5709
KIA	OK53Y63620	ML5706
KIA	OK53Z56620	ML5706
KIA	OK53Z56620A	ML5706
KIA	OK53Z56620B	ML5706

	OE N°:	Ref.
KIA	OK53Z56630	ML5706
KIA	OK53Z56630A	ML5706
KIA	OK53Z56630B	ML5706
KIA	OK53Z62620	ML5709
KIA	OK53Z62620A	ML5709
KIA	OK53Z63620	ML5709
KIA	OK53Z63620A	ML5709
KIA	811612G000	ML6342
KIA	811612T000	ML6343
KIA	811613C500	ML6341
KIA	811613C501	ML6341
KIA	811613C510	ML6341
KIA	811614D000	ML6118
KIA	817701D010	ML6002
KIA	817701G000	ML5712
KIA	817701H010	ML5723
KIA	817701H510	ML5839
KIA	817701P000	ML6171
KIA	817701Y000	ML6170
KIA	817701Y010	ML6170
KIA	817702F210	ML5713
KIA	817702K000	ML6236
KIA	817703W000	ML6206
KIA	81770A4000	ML6367
KIA	81770A4001	ML6367
KIA	817713C010	ML5710
KIA	817714D000	ML6234
KIA	817801D010	ML6002
KIA	817801G000	ML5712
KIA	817801H010	ML5723
KIA	817801H010	ML5723
KIA	817801H510	ML5839
KIA	817801P000	ML6171
KIA	817801W200	ML6235
KIA	817801W201	ML6235
KIA	817802F210	ML5713
KIA	817802K000	ML6236
KIA	817802P000	ML6119
KIA	817803W000	ML6206
KIA	81780A4000	ML6367
KIA	81780A4001	ML6367
KIA	817814D000	ML6234
KIA	871701F100	ML5700
KIA	OK01H62610E	ML5912

LADA



LADA	11188231015	ML6272
LADA	11198231010	ML6273
LADA	11198231010	ML6278
LADA	11198231015	ML6273
LADA	11198231015	ML6278
LADA	21086308010	ML5024
LADA	21086308015	ML5025
LADA	21088231010	ML5298
LADA	21118231010	ML5107
LADA	21118231010	ML6273
LADA	21118231010	ML6278
LADA	21118231015	ML5107
LADA	21118231015	ML5299
LADA	21118231015	ML6273
LADA	21118231015	ML6278
LADA	21128231010	ML5108
LADA	21128231015	ML5108
LADA	21216308010	ML5114
LADA	21236308010	ML5114
LADA	111908231015	ML6273
LADA	111908231015	ML6278
LADA	217208231015	ML6279
LADA	11180823101500	ML6272
LADA	11190823101500	ML6273

MONROE® MAX-LIFT® OE CROSS REFERENCE LIST



	OE N°:	Ref.		OE N°:	Ref.		OE N°:	Ref.
LADA	11190823101500	ML6278	LEXUS	645300W090	ML6145	MERCEDES	19808064	ML5674
LADA	21080823101005	ML5298	LEXUS	645300W091	ML6145	MERCEDES	1637400345	ML5530
LADA	21120823101000	ML6304	MAZDA			MERCEDES	1638800029	ML5559
LADA	21120823101500	ML6304	MAZDA	4095842	ML6307	MERCEDES	1647400145	ML5806
LADA	21720823101500	ML6279	MAZDA	4551620	ML6306	MERCEDES	1647400245	ML5806
LANCIA			MAZDA	4770700	ML6306	MERCEDES	1648800029	ML6024
LANCIA	5970097	ML5139	MAZDA	5T2478406A11BA	ML6306	MERCEDES	1648800129	ML6025
LANCIA	7703325	ML5139	MAZDA	8710NP000001	ML6237	MERCEDES	1649800364	ML6313
LANCIA	7792951	ML5159	MAZDA	8710NP000002	ML6238	MERCEDES	1649800464	ML6312
LANCIA	46309135	ML5541	MAZDA	96FBB406A10BA	ML5147	MERCEDES	1689800164	ML5188
LANCIA	46428438	ML5301	MAZDA	B1287F25	ML5403	MERCEDES	1689800964	ML5188
LANCIA	46429507	ML5483	MAZDA	B1287F26	ML5542	MERCEDES	1689801164	ML5188
LANCIA	46433702	ML5303	MAZDA	B28C62620B	ML5843	MERCEDES	1689801264	ML5188
LANCIA	46453835	ML5302	MAZDA	B28C62620C	ML5843	MERCEDES	1697400345	ML5717
LANCIA	46725028	ML5300	MAZDA	B28C63620B	ML5842	MERCEDES	1699800864	ML5718
LANCIA	46763101	ML5484	MAZDA	B28C63620C	ML5842	MERCEDES	1699800964	ML5718
LANCIA	46817935	ML5703	MAZDA	BBM456930A	ML6120	MERCEDES	1707500036	ML5680
LANCIA	46830389	ML5702	MAZDA	BN8W56930	ML5764	MERCEDES	1708800229	ML6032
LANCIA	51809199	ML6003	MAZDA	BN8W56930B	ML5764	MERCEDES	1717500036	ML5818
LANCIA	60617400	ML5139	MAZDA	BP4K62620D	ML5763	MERCEDES	1718800129	ML5798
LANCIA	82336687	ML5618	MAZDA	BP4K62620F	ML5763	MERCEDES	1719800164	ML5799
LANCIA	82380453	ML5619	MAZDA	BP4K63620D	ML5763	MERCEDES	1769800164	ML6210
LANCIA	82437256	ML5617	MAZDA	BP4K63620F	ML5763	MERCEDES	1769800264	ML6210
LANCIA	82473205	ML5540	MAZDA	C51362620A	ML6308	MERCEDES	1769800364	ML6210
LANCIA	82486283	ML5482	MAZDA	C51363620A	ML6308	MERCEDES	2029800364	ML5307
LANCIA	1479303080	ML5304	MAZDA	D65162620	ML5873	MERCEDES	2037400045	ML6173
LANCIA	1489342080	ML5458	MAZDA	DD1062620	ML5765	MERCEDES	2038800029	ML5577
LANCIA	9618278480	ML5304	MAZDA	DD1063620	ML5765	MERCEDES	2038800429	ML5560
LANCIA	9630698380	ML5305	MAZDA	EC0162620F	ML6306	MERCEDES	2039800164	ML5673
LANDROVER			MAZDA	EC01626B0C	ML6307	MERCEDES	2039800764	ML6017
LANDROVER	393091	ML5306	MAZDA	EC0163620D	ML6306	MERCEDES	2047400145	ML5719
LANDROVER	32028398	ML5872	MAZDA	EC01636B0C	ML6307	MERCEDES	2048800029	ML5715
LANDROVER	32030482	ML5870	MAZDA	EC01636B0D	ML6307	MERCEDES	2049800064	ML5715
LANDROVER	32030483	ML5870	MAZDA	ECO162620D	ML6306	MERCEDES	2049800564	ML6310
LANDROVER	32031392	ML5871	MAZDA	FE1556930C	ML6015	MERCEDES	2049800564	ML6311
LANDROVER	5H2216E610AA	ML5870	MAZDA	G14S63620	ML6337	MERCEDES	2079800564	ML5715
LANDROVER	5H22406A10BA	ML5871	MAZDA	G14S63620B	ML6337	MERCEDES	2079801264	ML5715
LANDROVER	6H5216C826BD	ML6006	MAZDA	G14S63620B	ML6338	MERCEDES	2087500036	ML6019
LANDROVER	6H52406A10AF	ML6005	MAZDA	G14S63620C	ML6337	MERCEDES	2087500336	ML6019
LANDROVER	ALR1050	ML5649	MAZDA	G14S63620C	ML6338	MERCEDES	2088800029	ML5308
LANDROVER	BHE760020	ML5872	MAZDA	G14S63620D	ML6337	MERCEDES	2099800064	ML5808
LANDROVER	BHE780012	ML5871	MAZDA	G14S63620D	ML6338	MERCEDES	2099800364	ML5808
LANDROVER	BHE790050	ML6209	MAZDA	G14S63620E	ML6337	MERCEDES	2099800464	ML5808
LANDROVER	BHE790053	ML6209	MAZDA	G14S63620E	ML6338	MERCEDES	2099800564	ML5808
LANDROVER	BJ32406A10AB	ML6207	MAZDA	G21B62620A	ML5684	MERCEDES	2108800229	ML5438
LANDROVER	BKK760010	ML6004	MAZDA	G21B63620A	ML5684	MERCEDES	2108800429	ML5438
LANDROVER	BKK780010	ML5870	MAZDA	GE4V62620D	ML5847	MERCEDES	2118800029	ML5309
LANDROVER	DPLA406A10AA	ML6305	MAZDA	GE4V63620D	ML5848	MERCEDES	2119800364	ML6021
LANDROVER	DPLA406A10AB	ML6305	MAZDA	GJ6A56930	ML6014	MERCEDES	2119800464	ML6021
LANDROVER	LR001773	ML6006	MAZDA	GJ6E56930	ML6014	MERCEDES	2158800029	ML5561
LANDROVER	LR002104	ML6005	MAZDA	GJ6J62620	ML5683	MERCEDES	2158800136	ML6028
LANDROVER	LR009106	ML5870	MAZDA	GJ6J62620B	ML5683	MERCEDES	2207500136	ML6028
LANDROVER	LR025379	ML6207	MAZDA	GJ6J63620	ML5683	MERCEDES	2208800329	ML5620
LANDROVER	LR044158	ML6305	MAZDA	GS1D56930C	ML6011	MERCEDES	2217500216	ML5813
LANDROVER	MXC7833	ML5306	MAZDA	GS1D56930C	ML6011	MERCEDES	2217500236	ML5813
LANDROVER	XH4216E610AA	ML6004	MAZDA	GS1M63620C	ML6012	MERCEDES	2218800329	ML6029
LANDROVER	XH42406A10AA	ML5872	MAZDA	GS2A63620C	ML6013	MERCEDES	2307500036	ML5800
LEXUS			MAZDA	NF7956930B	ML5810	MERCEDES	2308800029	ML5811
LEXUS	6895049065	ML6331	MAZDA	NF8056930B	ML5810	MERCEDES	2309800164	ML5801
LEXUS	6896049065	ML6331	MAZDA	TD1162620D	ML6238	MERCEDES	2309800264	ML5802
LEXUS	6896049205	ML6331	MAZDA	TD1163620D	ML6238	MERCEDES	2517400045	ML6030
LEXUS	534400W090	ML6008	MAZDA	TD1262620D	ML6237	MERCEDES	2518800129	ML6026
LEXUS	534400W091	ML6008	MAZDA	TD1263620D	ML6237	MERCEDES	2518800229	ML6027
LEXUS	534400W100	ML6009	MAZDA	YL847842105BC	ML6307	MERCEDES	2518800229	ML6027
LEXUS	534400W101	ML6009	MAZDA	YL8Z78406A11BA	ML6306	MERCEDES	4149800064	ML5543
LEXUS	534500W070	ML6008	MERCEDES			MERCEDES	6389800364	ML5329
LEXUS	534500W071	ML6008	MERCEDES	9802464	ML5102	MERCEDES	6389800464	ML5328
LEXUS	534500W080	ML6009	MERCEDES	9802564	ML5102	MERCEDES	6389800464	ML5621
LEXUS	534500W081	ML6009	MERCEDES	9803764	ML5102	MERCEDES	6399800364	ML5716
			MERCEDES	9808164	ML6309	MERCEDES	A0009808164	ML6309
						MERCEDES	A1247500036	ML6020

OE CROSS LIST



MONROE® MAX-LIFT® OE CROSS REFERENCE LIST

 OE N°:	Ref.	 OE N°:	Ref.	 OE N°:	Ref.			
MERCEDES	A1299800664	ML6031	NISSAN	80450EB31A	ML6285	OPEL	132532	ML5805
MERCEDES	A2049800564	ML6310	NISSAN	844302F000	ML5322	OPEL	132670	ML5120
MERCEDES	A2049800564	ML6311	NISSAN	844302F010	ML5321	OPEL	132673	ML6043
MERCEDES	A2049800764	ML6022	NISSAN	8443090J00	ML5524	OPEL	132675	ML5103
MERCEDES	A2049801064	ML6311	NISSAN	8443090J10	ML5525	OPEL	132677	ML5166
MERCEDES	A2049801164	ML6016	NISSAN	844309F500	ML5321	OPEL	132681	ML5257
MERCEDES	A2049801564	ML6023	NISSAN	84430AV600	ML5352	OPEL	132682	ML5398
MERCEDES	A2049802264	ML6016	NISSAN	893020F600	ML6121	OPEL	132691	ML5346
MERCEDES	A2119800464	ML6021	NISSAN	904501AA1A	ML6318	OPEL	132693	ML5391
MERCEDES	A2127400045	ML6016	NISSAN	904501KA2A	ML6211	OPEL	132694	ML5585
MERCEDES	A2208800329	ML5620	NISSAN	904501W302	ML5781	OPEL	132695	ML5586
MERCEDES	Q1A2469800264	ML6172	NISSAN	904501W312	ML5781	OPEL	132696	ML5527
MERCEDES	Q1A2469800564	ML6172	NISSAN	904503VA0A	ML6364	OPEL	132701	ML5390
MG			NISSAN	904503ZL1A	ML6340	OPEL	132702	ML5243
MG	AFP1282	ML5041	NISSAN	904504EA1A	ML6363	OPEL	132703	ML5244
MG	BHE140010	ML5410	NISSAN	904504F110	ML6040	OPEL	132704	ML5031
MG	BHE140020	ML5622	NISSAN	904504F111	ML6040	OPEL	132706	ML5834
MG	BHE45001	ML5434	NISSAN	9045055A10	ML5409	OPEL	132708	ML5408
MG	BHE450030	ML5434	NISSAN	9045073R00	ML6041	OPEL	132710	ML5407
MG	BHE500050	ML5412	NISSAN	9045079N02	ML5588	OPEL	132712	ML5585
MG	BHE500070	ML5623	NISSAN	904509C104	ML5582	OPEL	132713	ML5527
MG	BKK500010	ML6033	NISSAN	904509U00A	ML5701	OPEL	132714	ML5586
MG	BMH500010	ML5411	NISSAN	90450AX000	ML5360	OPEL	132715	ML5258
MINI			NISSAN	90450AX610	ML5360	OPEL	132716	ML5032
MINI	41626801258	ML5406	NISSAN	90450BM400	ML5672	OPEL	132717	ML5367
MINI	41626801258	ML6037	NISSAN	90450BM425	ML5672	OPEL	132718	ML5242
MINI	51237148864	ML6037	NISSAN	90450BU000	ML5579	OPEL	132719	ML5125
MINI	51237175020	ML5564	NISSAN	90450CB80A	ML6316	OPEL	132720	ML5156
MINI	51239802054	ML6177	NISSAN	90450EB31B	ML6285	OPEL	132721	ML5077
MINI	51247167442	ML6035	NISSAN	90450EQ300	ML5809	OPEL	132724	ML5054
MINI	51249801386	ML6176	NISSAN	90450EQ301	ML5809	OPEL	132725	ML5144
MINI	51249808987	ML6314	NISSAN	90450EQ30A	ML5809	OPEL	132726	ML5369
MINI	4162680125800	ML6036	NISSAN	90450EQ31A	ML5809	OPEL	132727	ML5082
MINI	5124714890200	ML6036	NISSAN	90450EQ325	ML5809	OPEL	132729	ML5515
MITSUBISHI			NISSAN	90450JD01B	ML5890	OPEL	132730	ML5515
MITSUBISHI	5802A007	ML5776	NISSAN	90450JG400	ML6042	OPEL	132731	ML5424
MITSUBISHI	5802A008	ML5776	NISSAN	90450JG40A	ML6042	OPEL	132734	ML5835
MITSUBISHI	5802A375	ML6315	NISSAN	904511AA1A	ML6318	OPEL	132735	ML5407
MITSUBISHI	5802A376	ML6315	NISSAN	904513VA0A	ML6364	OPEL	132736	ML5515
MITSUBISHI	8731Q1	ML5776	NISSAN	904513ZL1A	ML6340	OPEL	132737	ML5515
MITSUBISHI	MB926947	ML5578	NISSAN	904519C104	ML5582	OPEL	132739	ML5138
MITSUBISHI	MB927791	ML5354	NISSAN	904519C130	ML5582	OPEL	132741	ML5167
MITSUBISHI	MR101555	ML5278	NISSAN	90451AX000	ML5360	OPEL	132742	ML5137
MITSUBISHI	MR138596	ML5587	NISSAN	90451CB80A	ML6316	OPEL	132743	ML5669
MITSUBISHI	MR248939	ML5353	NISSAN	90451EB31A	ML6285	OPEL	132749	ML5722
MITSUBISHI	MR248940	ML5353	NISSAN	90451EB31B	ML6285	OPEL	132757	ML5721
MITSUBISHI	MR415171	ML6039	NISSAN	90451EQ30A	ML5809	OPEL	176105	ML6051
MITSUBISHI	MR415172	ML6039	NISSAN	90451EQ31A	ML5809	OPEL	176124	ML6051
MITSUBISHI	MR415173	ML6038	NISSAN	90451JG400	ML6042	OPEL	176387	ML5179
MITSUBISHI	MR415174	ML6038	NISSAN	90451JG40A	ML6042	OPEL	176413	ML5807
MITSUBISHI	MR959243	ML5661	NISSAN	904522F705	ML5433	OPEL	176414	ML5827
MITSUBISHI	MR959247	ML5662	NISSAN	904522F715	ML5580	OPEL	176541	ML6055
MITSUBISHI	MR991807	ML5757	NISSAN	904522F725	ML5433	OPEL	176546	ML6286
MITSUBISHI	MR991808	ML5757	NISSAN	904522F726	ML5580	OPEL	176601	ML5366
MOSKOVICH			NISSAN	904523F200	ML5318	OPEL	176602	ML5366
MOSKOVICH	21416306206	ML5004	NISSAN	904523F201	ML5317	OPEL	176603	ML5365
NISSAN			NISSAN	904523F202	ML5324	OPEL	176604	ML6047
NISSAN	4414419	ML5516	NISSAN	904526F100	ML5433	OPEL	176605	ML5210
NISSAN	8465124	ML5837	NISSAN	904526F126	ML5580	OPEL	176607	ML5341
NISSAN	91168256	ML5516	NISSAN	904528F825	ML5581	OPEL	176608	ML5773
NISSAN	7700303186	ML5837	NISSAN	9045298J26	ML5324	OPEL	176609	ML5817
NISSAN	7700308167	ML5837	NISSAN	904529F725	ML5423	OPEL	176676	ML6053
NISSAN	4A5827552	ML6269	NISSAN	90452AU200	ML5086	OPEL	176726	ML5119
NISSAN	654701AA0A	ML6317	NISSAN	90452AV700	ML5413	OPEL	1178224	ML5345
NISSAN	654701AA1A	ML6317	NISSAN	904601W301	ML5700	OPEL	1180016	ML6049
NISSAN	6547040U10	ML5624	NISSAN	904606W560	ML5700	OPEL	1180402	ML5085
NISSAN	654711AA0A	ML6317	OPEL			OPEL	1180405	ML5720
NISSAN	654711AA1A	ML6317	OPEL	132020	ML6055	OPEL	4414419	ML5516
NISSAN	6547140U10	ML5624	OPEL	132081	ML6178	OPEL	4705436	ML5088



MONROE® MAX-LIFT® OE CROSS REFERENCE LIST

	OE N°:	Ref.		OE N°:	Ref.		OE N°:	Ref.
OPEL	4705437	ML5089	OPEL	90227934	ML5258	PEUGEOT	7920071833	ML5364
OPEL	4705684	ML5088	OPEL	90227936	ML5032	PEUGEOT	9252280980	ML5625
OPEL	4705685	ML5089	OPEL	90241995	ML5407	PEUGEOT	9255607980	ML5628
OPEL	4708556	ML5078	OPEL	90241996	ML5407	PEUGEOT	9256119680	ML5020
OPEL	4708557	ML5078	OPEL	90246621	ML5408	PEUGEOT	9601430480	ML5180
OPEL	4708557	ML6044	OPEL	90275073	ML5366	PEUGEOT	9601430480	ML5426
OPEL	4808912	ML6046	OPEL	90275080	ML5366	PEUGEOT	9602673980	ML5583
OPEL	4809275	ML5888	OPEL	90275102	ML5365	PEUGEOT	9603762280	ML5202
OPEL	5132262	ML5119	OPEL	90341282	ML5077	PEUGEOT	9603762380	ML5326
OPEL	5132267	ML6057	OPEL	90341377	ML5156	PEUGEOT	9605478880	ML5133
OPEL	8186084E00	ML6044	OPEL	90341378	ML5125	PEUGEOT	9605478888	ML5133
OPEL	9114311	ML5120	OPEL	90346469	ML5367	PEUGEOT	9610016680	ML5148
OPEL	9152393	ML5257	OPEL	90379054	ML5210	PEUGEOT	9612504980	ML5180
OPEL	9177081	ML5341	OPEL	90379081	ML5103	PEUGEOT	9612504980	ML5426
OPEL	9180255	ML5773	OPEL	90388707	ML5144	PEUGEOT	9617046480	ML5323
OPEL	9180256	ML5817	OPEL	90463253	ML5179	PEUGEOT	9619988380	ML5148
OPEL	9209569	ML5088	OPEL	90463721	ML5085	PEUGEOT	9622165080	ML5316
OPEL	9209570	ML5089	OPEL	90463749	ML5082	PEUGEOT	9626771680	ML5319
OPEL	9210307	ML5088	OPEL	90463781	ML5424	PEUGEOT	9628157780	ML5470
OPEL	9210308	ML5089	OPEL	90481180	ML5369	PEUGEOT	9629219580	ML5267
OPEL	10233372	ML5515	OPEL	90481269	ML5242	PEUGEOT	9630662480	ML5470
OPEL	10233373	ML5515	OPEL	90481270	ML5054	PEUGEOT	9637115080	ML5343
OPEL	10400854	ML5515	OPEL	90486893	ML6047	PEUGEOT	9638605280	ML5425
OPEL	10400855	ML5515	OPEL	90521517	ML5166	PEUGEOT	9642209980	ML5469
OPEL	13101335	ML5346	OPEL	90559245	ML5138	PEUGEOT	9642210080	ML5340
OPEL	13122695	ML5721	OPEL	90579440	ML5137	PEUGEOT	9647261480	ML5727
OPEL	13128759	ML5722	OPEL	91163328	ML6057	PEUGEOT	9647487680	ML5728
OPEL	13182309	ML5807	OPEL	91168256	ML5516	PEUGEOT	9647487880	ML5729
OPEL	13182537	ML5827	OPEL	93193385	ML5078	PEUGEOT	9649587680	ML5730
OPEL	13191401	ML5817	OPEL	93193386	ML5078	PEUGEOT	9656592980	ML5727
OPEL	13220159	ML5805	OPEL	93193386	ML6044	PEUGEOT	9656593180	ML5729
OPEL	13241974	ML5773	OPEL	93386999	ML5119	PEUGEOT	9676494780	ML6180
OPEL	13241975	ML5119	OPEL	93867088	ML6178	PEUGEOT	9678317180	ML6360
OPEL	13243589	ML5723	OPEL	96661403	ML5888	PEUGEOT	9683207080	ML6123
OPEL	13246577	ML6051	OPEL	96664104	ML6046	PEUGEOT	9683422380	ML6060
OPEL	13247868	ML5817	OPEL	96830123	ML5888	PEUGEOT	9800805480	ML6352
OPEL	13247949	ML6053	OPEL	97211748	ML6043	PEUGEOT	9813913880	ML6352
OPEL	13252173	ML6049	OPEL	919993200	ML6146	PEUGEOT	873E08	ML5363
OPEL	13253100	ML6146	OPEL	13270990246620	ML5408	PEUGEOT	873E09	ML5146
OPEL	13258179	ML6122	OPEL	8186083E10X10	ML6044	PEUGEOT	962E09	ML5432
OPEL	13278257	ML6055	PEUGEOT			PEUGEOT	964E09	ML5183
OPEL	13284105	ML6240	PEUGEOT	347040	ML5471	PEUGEOT	873E12	ML5183
OPEL	13332885	ML6055	PEUGEOT	792505	ML5583	PEUGEOT	862214E15	ML5625
OPEL	13338367	ML6179	PEUGEOT	792506	ML5268	PEUGEOT	5802A007	ML5776
OPEL	13370050	ML6286	PEUGEOT	792507	ML5517	PEUGEOT	5802A008	ML5776
OPEL	13379051	ML6335	PEUGEOT	792508	ML5470	PEUGEOT	689500H020	ML5687
OPEL	13387067	ML6239	PEUGEOT	792509	ML5267	PEUGEOT	689500H040	ML6353
OPEL	13428038	ML6361	PEUGEOT	792510	ML5470	PEUGEOT	7000210271C0	ML6180
OPEL	13428064	ML6362	PEUGEOT	792515	ML5160	PEUGEOT	8731A1	ML5316
OPEL	13437377	ML6286	PEUGEOT	792516	ML5788	PEUGEOT	8731A2	ML5323
OPEL	24411022	ML5167	PEUGEOT	862214	ML5625	PEUGEOT	8731A3	ML5626
OPEL	24454473	ML5345	PEUGEOT	862215	ML5628	PEUGEOT	8731A7	ML5180
OPEL	24463829	ML5669	PEUGEOT	873E03	ML5113	PEUGEOT	8731C1	ML5627
OPEL	24465295	ML5720	PEUGEOT	873143	ML5067	PEUGEOT	8731C5	ML5319
OPEL	90043132	ML5398	PEUGEOT	873148	ML5364	PEUGEOT	8731C9	ML5471
OPEL	90119276	ML5585	PEUGEOT	873149	ML5364	PEUGEOT	8731F2	ML5343
OPEL	90127136	ML5585	PEUGEOT	873151	ML5311	PEUGEOT	8731F8	ML5425
OPEL	90127137	ML5527	PEUGEOT	873178	ML5202	PEUGEOT	8731F9	ML5358
OPEL	90127138	ML5586	PEUGEOT	873179	ML5326	PEUGEOT	8731G4	ML5340
OPEL	90138517	ML5527	PEUGEOT	873183	ML5426	PEUGEOT	8731G5	ML5469
OPEL	90138518	ML5586	PEUGEOT	873185	ML5133	PEUGEOT	8731G6	ML5344
OPEL	90158125	ML5391	PEUGEOT	873186	ML5133	PEUGEOT	8731G9	ML5358
OPEL	90159607	ML5031	PEUGEOT	873191	ML5134	PEUGEOT	8731J3	ML5730
OPEL	90159629	ML5834	PEUGEOT	873193	ML5148	PEUGEOT	8731J6	ML5728
OPEL	90191627	ML5244	PEUGEOT	873E04	ML5432	PEUGEOT	8731K4	ML5727
OPEL	90191920	ML5243	PEUGEOT	510E07	ML5146	PEUGEOT	8731K5	ML5729
OPEL	90195260	ML5390	PEUGEOT	7000510263	ML6058	PEUGEOT	8731L0	ML5687
OPEL	90195260	ML5395	PEUGEOT	7000510264	ML6060	PEUGEOT	8731L2	ML6280
OPEL	90196023	ML5835	PEUGEOT	7920062656	ML5067	PEUGEOT	8731L6	ML6061



MONROE® MAX-LIFT® OE CROSS REFERENCE LIST

	OE N°:	Ref.		OE N°:	Ref.		OE N°:	Ref.
PEUGEOT	8731L7	ML5731	RENAULT	7700418621	ML5158	RENAULT	8200299546	ML5725
PEUGEOT	8731P8	ML5733	RENAULT	7700421906	ML5155	RENAULT	8200362400	ML5473
PEUGEOT	8731P9	ML5732	RENAULT	7700427547	ML5383	RENAULT	8200377199	ML5826
PEUGEOT	8731Q0	ML5732	RENAULT	7700430022	ML5153	RENAULT	8200377789	ML5475
PEUGEOT	8731Q1	ML5776	RENAULT	7700434465	ML5152	RENAULT	8200385560	ML5891
PEUGEOT	8731Q5	ML6060	RENAULT	7700753540	ML5633	RENAULT	8200461349	ML6075
PEUGEOT	8731Q6	ML5734	RENAULT	7700785587	ML5632	RENAULT	8200497806	ML5892
PEUGEOT	8731Q7	ML5889	RENAULT	7700786247	ML5004	RENAULT	8200583852	ML5656
PEUGEOT	8731Q8	ML6058	RENAULT	7700786248	ML5256	RENAULT	770E09	ML5894
PEUGEOT	8731Q9	ML5950	RENAULT	7700787749	ML5337	RENAULT	654700008R	ML6127
PEUGEOT	8731R8	ML5956	RENAULT	7700795698	ML5631	RENAULT	654703934R	ML6215
PEUGEOT	8731S0	ML5948	RENAULT	7700795731	ML5631	RENAULT	654710003R	ML6074
PEUGEOT	8731S7	ML5851	RENAULT	7700799026	ML5004	RENAULT	7000210535D0	ML6215
PEUGEOT	8731T4	ML6123	RENAULT	7700799027	ML5256	RENAULT	7000510521C0	ML6126
PEUGEOT	8731V2	ML6124	RENAULT	7700800311	ML5093	RENAULT	7000510523B0	ML6128
PEUGEOT	8731V6	ML5954	RENAULT	7700807057	ML5315	RENAULT	7000510524B0	ML6125
PEUGEOT	8731VO	ML5968	RENAULT	7700810554	ML5254	RENAULT	844300001R	ML5657
PEUGEOT	8731W3	ML6213	RENAULT	7700811019	ML5554	RENAULT	844300004R	ML5893
PEUGEOT	8731W4	ML6181	RENAULT	7700811570	ML5310	RENAULT	844300006R	ML6126
PEUGEOT	B000877780	ML6353	RENAULT	7700812193	ML5327	RENAULT	844300009R	ML6073
PEUGEOT	YM17341080	ML6253	RENAULT	7700815135	ML5331	RENAULT	844308861R	ML6214
PORSCHE			RENAULT	7700818237	ML5094	RENAULT	844310002R	ML5893
PORSCHE	9115113310	ML5646	RENAULT	7700823271	ML5279	RENAULT	904500004R	ML6128
PORSCHE	91151133100	ML6251	RENAULT	7700824817	ML5553	RENAULT	904505599R	ML6070
PORSCHE	91151233101	ML5595	RENAULT	7700828451	ML5131	RENAULT	904507914R	ML6244
PORSCHE	91151233102	ML5594	RENAULT	7700828454	ML5130	RENAULT	904510001R	ML6071
PORSCHE	92851113903	ML5676	RENAULT	7700829764	ML5279	RENAULT	904510002R	ML6072
PORSCHE	92851113905	ML5676	RENAULT	7700829825	ML5555	RENAULT	904510005R	ML6125
PORSCHE	94451135101	ML5846	RENAULT	7700831959	ML5554	RENAULT	904511881R	ML6339
PORSCHE	95551135900	ML6069	RENAULT	7700832534	ML5555	RENAULT	904513981R	ML6070
PORSCHE	95551252800	ML6068	RENAULT	7700838005	ML5383	RENAULT	904514876R	ML6242
PORSCHE	95851135900	ML6319	RENAULT	7700838006	ML5547	RENAULT	904520001R	ML6243
PORSCHE	98651255101	ML6066	RENAULT	7700838487	ML5526	RENAULT	904600001R	ML6063
PORSCHE	98751255101	ML6067	RENAULT	7700838612	ML5182	RENAULT	E84827465A	ML5894
PORSCHE	98751255103	ML6241	RENAULT	7700838690	ML5526	ROVER		
PORSCHE	98751255104	ML6241	RENAULT	7700842152	ML5279	ROVER	AFP1282	ML5041
PORSCHE	98751255105	ML6067	RENAULT	7700842153	ML5279	ROVER	BEP6628	ML5362
PORSCHE	98751255106	ML6241	RENAULT	7700842256	ML5241	ROVER	BHE140010	ML5410
PORSCHE	98751255107	ML6241	RENAULT	7700843698	ML5131	ROVER	BHE140020	ML5478
PORSCHE	99351133100	ML6062	RENAULT	7700846538	ML5383	ROVER	BHE38017	ML5634
PORSCHE	99651155101	ML6147	RENAULT	7700846772	ML5544	ROVER	BHE38025	ML5192
PORSCHE	99651255102	ML6065	RENAULT	7700846773	ML5545	ROVER	BHE39005	ML5208
PORSCHE	99651255103	ML6065	RENAULT	7700848404	ML5686	ROVER	BHE39006	ML5209
PORSCHE	99751155101	ML5803	RENAULT	7700848464	ML5686	ROVER	BHE41003	ML5384
PORSCHE	99751255100	ML5804	RENAULT	7701033344	ML5549	ROVER	BHE41004	ML5384
PORSCHE	7L5823359	ML6069	RENAULT	7701057303	ML6073	ROVER	BHE45001	ML5434
PORSCHE	7L5845587B	ML6068	RENAULT	7702144629	ML5021	ROVER	BHE45003	ML5394
PORSCHE	7P5823359	ML6319	RENAULT	7702149568	ML5630	ROVER	BHE450030	ML5394
RENAULT			RENAULT	7703024021	ML5548	ROVER	BHE450030	ML5434
RENAULT	8453460	ML5724	RENAULT	8200000896	ML5548	ROVER	BHE450030	ML5815
RENAULT	8489348	ML5826	RENAULT	8200000902	ML5189	ROVER	BHE500050	ML5412
RENAULT	32062565	ML5725	RENAULT	8200000903	ML5440	ROVER	BHE500070	ML5479
RENAULT	6025001988	ML5629	RENAULT	8200003020	ML5190	ROVER	BHM410040	ML5338
RENAULT	6025003919	ML5629	RENAULT	8200021974	ML5518	ROVER	BKK41003	ML5359
RENAULT	6025005935	ML5320	RENAULT	8200021975	ML5519	ROVER	BKK500010	ML6033
RENAULT	6025006621	ML5320	RENAULT	8200025105	ML5551	ROVER	BMH38003	ML6148
RENAULT	6025100991	ML5546	RENAULT	8200025317	ML5474	ROVER	BMH38004	ML6148
RENAULT	6025101952	ML5313	RENAULT	8200051750	ML5212	ROVER	BMH500010	ML5411
RENAULT	6025106762	ML5314	RENAULT	8200091749	ML5472	ROVER	GSA922	ML5208
RENAULT	6025300735	ML5228	RENAULT	8200119497	ML5789	ROVER	GSA923	ML5209
RENAULT	6025305941	ML5229	RENAULT	8200119498	ML5372	ROVER	GSA925	ML5192
RENAULT	6025306563	ML5230	RENAULT	8200119500	ML5475	ROVER	GSA930	ML5634
RENAULT	6025312658	ML5546	RENAULT	8200130187	ML5552	ROVER	GTS120	ML5192
RENAULT	6025401711	ML5351	RENAULT	8200135264	ML5812	ROVER	GTS122	ML5634
RENAULT	7700272026	ML5093	RENAULT	8200162697	ML5550	SAAB		
RENAULT	7700303139	ML5128	RENAULT	8200174571	ML5826	SAAB	4006060	ML5557
RENAULT	7700303186	ML5128	RENAULT	8200212598	ML5828	SAAB	4006078	ML5495
RENAULT	7700413083	ML5476	RENAULT	8200219322	ML5724	SAAB	4323994	ML5350
RENAULT	7700414002	ML5477	RENAULT	8200219323	ML6075	SAAB	4323994	ML5636



MONROE® MAX-LIFT® OE CROSS REFERENCE LIST

	OE N°:	Ref.		OE N°:	Ref.		OE N°:	Ref.
SAAB	4324307	ML5401	SEAT	7M3827550A	ML5480	SKODA	6U0827551B	ML5061
SAAB	4326468	ML5400	SEAT	7N0823359	ML6217	SKODA	6Y0827550A	ML5175
SAAB	4699260	ML5637	SEAT	7N0827550	ML6216	SKODA	6Y5827550A	ML5135
SAAB	4699260	ML5638	SEAT	7N0823359	ML6217	SMART		
SAAB	4854717	ML5375	SEAT	8E0823359A	ML5386	SMART	113000013	ML5640
SAAB	4854733	ML5375	SEAT	8L0823359	ML5284	SMART	0000618V007	ML5640
SAAB	4854741	ML6076	SEAT	8E0823359	ML5284	SMART	0009223V	ML5813
SAAB	4854758	ML6076	SEAT	SE021526200A	ML5022	SMART	0009223V005	ML5813
SAAB	4855094	ML5558	SEAT	SE02252620A	ML5011	SMART	A4519880004	ML6083
SAAB	5022082	ML5397	SEAT	SE023529200A	ML5639	SMART	A4547400145	ML5895
SAAB	5117015	ML5558	SEAT	SE028526200B	ML5016	SMART	Q0009223V003000000	ML5813
SAAB	5183017	ML5349	SEAT	W06K5827550	ML5063	SMART	Q0009235V004000000	ML6082
SAAB	5360821	ML5638	SEAT	W06K6827550	ML5140	SMART	Q0009235V005000000	ML6082
SAAB	5360839	ML5558	SEAT	W110827550	ML5124	SSANGYONG		
SAAB	6956262	ML5498	SEAT	XO39303770	ML5042	SSANGYONG	7115008100	ML5355
SAAB	6956270	ML5499	SEAT	XO39401990	ML5010	SSANGYONG	7140608100	ML5334
SAAB	6956288	ML5494	SEAT	XO3940480	ML5011	SSANGYONG	7140608110	ML5334
SAAB	6976369	ML5496	SEAT	XO39462450	ML5011	SSANGYONG	7141608100	ML5334
SAAB	9231796	ML5613	SEAT	XO39481770	ML5501	SSANGYONG	7141608100	ML5334
SAAB	9233727	ML5613	SEAT	XO39503120	ML5022	SSANGYONG	7141608110	ML5334
SAAB	9233727	ML5613	SEAT	XO39507910	ML5022	SSANGYONG	7143608100	ML5356
SAAB	9253964	ML5497	SEAT	XO39507910	ML5022	SSANGYONG	7145009000	ML5889
SAAB	9270240	ML5556	SEAT	XO39543290	ML5639	SSANGYONG	7145009000	ML5889
SAAB	9293580	ML5635	SEAT	XO39553290	ML5016	SUBARU		
SAAB	9293580	ML5635	SEAT	XO42977420	ML5015	SUBARU	60315FA010	ML5820
SAAB	12761582	ML5638	SKODA			SUBARU	60335FA000	ML5820
SAAB	12778556	ML5852	SKODA	41964420476	ML5048	SUBARU	60335FA100	ML5820
SAAB	12785021	ML5790	SKODA	441564420066	ML5036	SUBARU	60335FA120	ML5820
SAAB	12797509	ML5852	SKODA	441664420076	ML5037	SUBARU	63269FE000	ML5819
SAAB	12831543	ML5766	SKODA	441664420086	ML5057	SUBARU	68950B1031	ML6084
SAAB	30586552	ML5349	SKODA	441964420476	ML5061	SUBARU	68960B1031	ML6084
SAAB	104323994	ML5350	SKODA	441964420486	ML5044	SUBARU	8185086G00	ML5780
SAAB	104854733	ML5402	SKODA	441964920386	ML5005	SUBARU	8186086G00	ML5780
SAAB	105183017	ML5349	SKODA	1U6827550	ML5217	SUZUKI		
SAAB	127850021	ML5790	SKODA	1U6827550A	ML5217	SUZUKI	4705436	ML6044
SAAB	1012831543	ML5766	SKODA	1U6827550B	ML5217	SUZUKI	4705437	ML6044
SEAT			SKODA	1U6827550C	ML5217	SUZUKI	8185084E00	ML5088
SEAT	110827550	ML5124	SKODA	1U6827550E	ML5218	SUZUKI	8186084E00	ML5089
SEAT	110827550A	ML5124	SKODA	1U6827550F	ML5219	SUZUKI	8180062831	ML5091
SEAT	1M0823359A	ML5342	SKODA	1U6827550G	ML5220	SUZUKI	8180062841	ML5092
SEAT	1M5827550B	ML5193	SKODA	1U6827550H	ML5221	SUZUKI	8180063811	ML6086
SEAT	1M6827550A	ML5181	SKODA	1U9827550A	ML5045	SUZUKI	8185051810	ML5078
SEAT	1P0827550	ML5767	SKODA	1U9827550B	ML5045	SUZUKI	8186051810	ML5078
SEAT	1P0827550A	ML5767	SKODA	1Z5827550	ML5665	SUZUKI	8186051810	ML5078
SEAT	1S7827550B	ML6245	SKODA	1Z5827550B	ML5665	SUZUKI	8180162811000	ML6086
SEAT	3R9827550	ML6129	SKODA	1Z5827550C	ML5665	SUZUKI	8185083E10	ML5088
SEAT	5F3827550A	ML6320	SKODA	1Z5827550C	ML6332	SUZUKI	8186083E10	ML5089
SEAT	5F9827550B	ML6321	SKODA	1Z5827550D	ML5665	SUZUKI	8185061M00	ML6336
SEAT	5P0827550A	ML5100	SKODA	1Z5827550D	ML5665	SUZUKI	8185062B20	ML5091
SEAT	5P5827550	ML5584	SKODA	1Z5827550E	ML6332	SUZUKI	8185062J00	ML6086
SEAT	5P8827550	ML5845	SKODA	1Z5827550E	ML6332	SUZUKI	8185062J00	ML6086
SEAT	6E0827550C	ML5195	SKODA	1Z5827550F	ML5665	SUZUKI	8185068L00	ML6219
SEAT	6J3827550	ML6078	SKODA	1Z5827550F	ML6332	SUZUKI	8185079J00	ML5779
SEAT	6J4827550	ML5850	SKODA	1Z9827550	ML5667	SUZUKI	8185086G00000	ML5780
SEAT	6J4827550B	ML5850	SKODA	3B5827550E	ML5439	SUZUKI	8185086G00X10	ML5780
SEAT	6J8827550B	ML6183	SKODA	3T0823359	ML6079	SUZUKI	81850M68K00	ML6131
SEAT	6K0827550	ML5100	SKODA	3T5827550	ML6080	SUZUKI	81850M76G20A	ML5589
SEAT	6K0827550A	ML5100	SKODA	3T5827552	ML6081	SUZUKI	8185185C00	ML6085
SEAT	6K5827550	ML5063	SKODA	3T9827550	ML6218	SUZUKI	8186062B20	ML5092
SEAT	6K5827550C	ML5259	SKODA	3T9827550	ML6218	SUZUKI	8186068L00	ML6219
SEAT	6K6827550	ML5140	SKODA	3T982755001S	ML6218	SUZUKI	8186068L00	ML6219
SEAT	6K6827550A	ML5211	SKODA	3U0823359	ML5768	SUZUKI	8186079J00	ML5779
SEAT	6L5827550B	ML5778	SKODA	5E5827550	ML6289	SUZUKI	8186079J01	ML5779
SEAT	6L6827550B	ML5225	SKODA	5E5827550A	ML6289	SUZUKI	8186086G00000	ML5780
SEAT	6R9827550	ML6129	SKODA	5E9827550	ML6288	SUZUKI	81860A80100	ML5492
SEAT	6X0827550	ML5284	SKODA	5J6827550B	ML5681	SUZUKI	81860M68K00	ML6131
SEAT	6X0827550A	ML5284	SKODA	5J7827550	ML5682	SUZUKI	81860M70F10000	ML5589
SEAT	7M0827550D	ML5127	SKODA	5J827550A	ML6322	SUZUKI	81860M76G20A	ML5589
SEAT	7M0827550F	ML5127	SKODA	5J827550B	ML6322	SUZUKI	9390085C00	ML5493
SEAT	7M0827550G	ML5127	SKODA	5J827550C	ML6322	TOYOTA		
SEAT	7M3823359A	ML5480	SKODA	5J827550D	ML6322	TOYOTA	5344069026	ML6324
			SKODA	5L6827550	ML6130	TOYOTA	5344069075	ML6325
			SKODA	6U0827551A	ML5061	TOYOTA	5344069105	ML6345

MONROE® MAX-LIFT® OE CROSS REFERENCE LIST



	OE N°:	Ref.		OE N°:	Ref.		OE N°:	Ref.
TOYOTA	5344069135	ML6345	TOYOTA	689600F030	ML6135	VAUXHALL	176604	ML6047
TOYOTA	5345006042	ML6368	TOYOTA	689600F031	ML6135	VAUXHALL	176605	ML5210
TOYOTA	5345069026	ML6324	TOYOTA	689600Q010	ML6134	VAUXHALL	176607	ML5341
TOYOTA	5345069075	ML6325	TOYOTA	689600W091	ML5641	VAUXHALL	176608	ML5773
TOYOTA	5345069105	ML6345	TOYOTA	689600W140	ML5486	VAUXHALL	176609	ML5817
TOYOTA	5345069135	ML6345	TOYOTA	689600W170	ML5485	VAUXHALL	176676	ML6053
TOYOTA	5345069145	ML6345	TOYOTA	689600W240	ML5917	VAUXHALL	1178224	ML5345
TOYOTA	6894005072	ML5699	TOYOTA	689600W531	ML6134	VAUXHALL	1180016	ML6049
TOYOTA	6895002020	ML5963	TOYOTA	689600W570	ML6133	VAUXHALL	1180402	ML5085
TOYOTA	6895002020	ML6087	TOYOTA	689600W580	ML6133	VAUXHALL	4414419	ML5516
TOYOTA	6895002030	ML5963	TOYOTA	689600W620	ML6184	VAUXHALL	4705436	ML5088
TOYOTA	6895002040	ML5485	TOYOTA	873110	ML6151	VAUXHALL	4705437	ML5089
TOYOTA	6895002091	ML5900	UAZ			VAUXHALL	4705684	ML5088
TOYOTA	6895002140	ML6359	UAZ	12823101501	ML6283	VAUXHALL	4705685	ML5089
TOYOTA	6895005010	ML6089	UAZ	21086308015	ML5025	VAUXHALL	4708556	ML5078
TOYOTA	6895005020	ML6089	VAG			VAUXHALL	4708557	ML5078
TOYOTA	6895005050	ML5121	VAG	701829331T	ML5248	VAUXHALL	5132262	ML5119
TOYOTA	6895005060	ML5699	VAUXHALL			VAUXHALL	9114311	ML5120
TOYOTA	6895005080	ML6132	VAUXHALL	132020	ML6055	VAUXHALL	9152393	ML5257
TOYOTA	6895009050	ML5592	VAUXHALL	132081	ML6178	VAUXHALL	9177081	ML5341
TOYOTA	6895009080	ML5592	VAUXHALL	132670	ML5120	VAUXHALL	9180255	ML5773
TOYOTA	6895009090	ML5963	VAUXHALL	132675	ML5103	VAUXHALL	9180256	ML5817
TOYOTA	6895009090	ML6087	VAUXHALL	132677	ML5166	VAUXHALL	9209569	ML5088
TOYOTA	6895009100	ML5963	VAUXHALL	132681	ML5257	VAUXHALL	9209570	ML5089
TOYOTA	6895009110	ML5821	VAUXHALL	132682	ML5398	VAUXHALL	9210307	ML5088
TOYOTA	6895009140	ML5647	VAUXHALL	132691	ML5346	VAUXHALL	9210308	ML5089
TOYOTA	6895009140	ML5699	VAUXHALL	132693	ML5391	VAUXHALL	10233372	ML5515
TOYOTA	6895009150	ML5699	VAUXHALL	132694	ML5585	VAUXHALL	10233373	ML5515
TOYOTA	6896002010	ML5963	VAUXHALL	132695	ML5586	VAUXHALL	10400854	ML5515
TOYOTA	6896002010	ML6087	VAUXHALL	132696	ML5527	VAUXHALL	10400855	ML5515
TOYOTA	6896002020	ML5963	VAUXHALL	132701	ML5390	VAUXHALL	13101335	ML5346
TOYOTA	6896002030	ML5485	VAUXHALL	132702	ML5243	VAUXHALL	13128759	ML5722
TOYOTA	6896002081	ML5900	VAUXHALL	132703	ML5244	VAUXHALL	13182309	ML5807
TOYOTA	6896002130	ML6359	VAUXHALL	132704	ML5031	VAUXHALL	13182537	ML5827
TOYOTA	6896005050	ML5121	VAUXHALL	132706	ML5528	VAUXHALL	13191401	ML5817
TOYOTA	6896005060	ML5699	VAUXHALL	132708	ML5408	VAUXHALL	13241974	ML5773
TOYOTA	6896005072	ML5699	VAUXHALL	132710	ML5407	VAUXHALL	13246577	ML6051
TOYOTA	6896005081	ML6132	VAUXHALL	132712	ML5585	VAUXHALL	13247868	ML5817
TOYOTA	6896009050	ML5592	VAUXHALL	132713	ML5527	VAUXHALL	13247949	ML6053
TOYOTA	6896009060	ML5963	VAUXHALL	132714	ML5586	VAUXHALL	13252173	ML6049
TOYOTA	6896009060	ML6087	VAUXHALL	132715	ML5258	VAUXHALL	13278257	ML6055
TOYOTA	6896009080	ML5592	VAUXHALL	132716	ML5032	VAUXHALL	13321298	ML6051
TOYOTA	6896009090	ML5647	VAUXHALL	132717	ML5367	VAUXHALL	13332570	ML6051
TOYOTA	6896009090	ML5699	VAUXHALL	132718	ML5242	VAUXHALL	13332885	ML6055
TOYOTA	6896009100	ML5699	VAUXHALL	132719	ML5125	VAUXHALL	24411022	ML5167
TOYOTA	6896009120	ML5821	VAUXHALL	132720	ML5156	VAUXHALL	24454473	ML5345
TOYOTA	53440AA011	ML6323	VAUXHALL	132721	ML5077	VAUXHALL	90043132	ML5398
TOYOTA	689500D020	ML5777	VAUXHALL	132724	ML5054	VAUXHALL	90119276	ML5585
TOYOTA	689500D021	ML5777	VAUXHALL	132725	ML5144	VAUXHALL	90127136	ML5585
TOYOTA	689500D022	ML5777	VAUXHALL	132726	ML5369	VAUXHALL	90127137	ML5527
TOYOTA	689500F010	ML5666	VAUXHALL	132727	ML5082	VAUXHALL	90127138	ML5586
TOYOTA	689500F011	ML5666	VAUXHALL	132729	ML5515	VAUXHALL	90138517	ML5527
TOYOTA	689500F012	ML5666	VAUXHALL	132730	ML5515	VAUXHALL	90138518	ML5586
TOYOTA	689500F030	ML6135	VAUXHALL	132731	ML5424	VAUXHALL	90158125	ML5391
TOYOTA	689500F031	ML6135	VAUXHALL	132734	ML5835	VAUXHALL	90159607	ML5031
TOYOTA	689500H010	ML6151	VAUXHALL	132735	ML5407	VAUXHALL	90159629	ML5528
TOYOTA	689500H020	ML6151	VAUXHALL	132736	ML5515	VAUXHALL	90191627	ML5244
TOYOTA	689500Q010	ML6134	VAUXHALL	132737	ML5515	VAUXHALL	90191920	ML5243
TOYOTA	689500W101	ML5641	VAUXHALL	132739	ML5138	VAUXHALL	90195260	ML5390
TOYOTA	689500W140	ML5486	VAUXHALL	132741	ML5167	VAUXHALL	90195260	ML5395
TOYOTA	689500W170	ML5485	VAUXHALL	132742	ML5137	VAUXHALL	90196023	ML5835
TOYOTA	689500W251	ML5917	VAUXHALL	132749	ML5722	VAUXHALL	90227934	ML5258
TOYOTA	689500W541	ML6134	VAUXHALL	176387	ML5179	VAUXHALL	90227936	ML5032
TOYOTA	689600D010	ML5777	VAUXHALL	176413	ML5807	VAUXHALL	90241995	ML5407
TOYOTA	689600D011	ML5777	VAUXHALL	176414	ML5827	VAUXHALL	90241996	ML5407
TOYOTA	689600D012	ML5777	VAUXHALL	176541	ML6055	VAUXHALL	90246621	ML5408
TOYOTA	689600F010	ML5666	VAUXHALL	176601	ML5366	VAUXHALL	90275073	ML5366
TOYOTA	689600F011	ML5666	VAUXHALL	176602	ML5366	VAUXHALL	90275080	ML5366
TOYOTA	689600F012	ML5666	VAUXHALL	176603	ML5365	VAUXHALL	90275102	ML5365

MONROE® MAX-LIFT® OE CROSS REFERENCE LIST

	OE N°:	Ref.		OE N°:	Ref.		OE N°:	Ref.
VAUXHALL	90341282	ML5077	VOLKSWAGEN	1T0827550C	ML5743	VOLKSWAGEN	6Q5827550B	ML5748
VAUXHALL	90341377	ML5156	VOLKSWAGEN	1T0827550D	ML5743	VOLKSWAGEN	6Q6827550	ML5194
VAUXHALL	90341378	ML5125	VOLKSWAGEN	1T0827550E	ML5743	VOLKSWAGEN	6Q6827550	ML5196
VAUXHALL	90346469	ML5367	VOLKSWAGEN	1T0827550H	ML6188	VOLKSWAGEN	6Q6827550A	ML5196
VAUXHALL	90379054	ML5210	VOLKSWAGEN	1Y0827550B	ML5791	VOLKSWAGEN	6R6827550A	ML5849
VAUXHALL	90379081	ML5103	VOLKSWAGEN	1Y0827550D	ML5791	VOLKSWAGEN	6X0823359A	ML5195
VAUXHALL	90388707	ML5144	VOLKSWAGEN	1Y0827550F	ML5791	VOLKSWAGEN	6X0823359B	ML5287
VAUXHALL	90463253	ML5179	VOLKSWAGEN	251829331A	ML5645	VOLKSWAGEN	6X0823359C	ML5339
VAUXHALL	90463721	ML5085	VOLKSWAGEN	251829331B	ML5106	VOLKSWAGEN	6X0827550	ML5261
VAUXHALL	90463749	ML5082	VOLKSWAGEN	2H782755001	ML6329	VOLKSWAGEN	6X0827550A	ML5261
VAUXHALL	90463781	ML5424	VOLKSWAGEN	2K0827550	ML5750	VOLKSWAGEN	701829331AB	ML5250
VAUXHALL	90481180	ML5369	VOLKSWAGEN	2K0827550A	ML5750	VOLKSWAGEN	701829331F	ML5246
VAUXHALL	90481269	ML5242	VOLKSWAGEN	3A9827550	ML5123	VOLKSWAGEN	701829331G	ML5245
VAUXHALL	90481270	ML5054	VOLKSWAGEN	3AA823359A	ML6185	VOLKSWAGEN	701829331H	ML5105
VAUXHALL	90486893	ML6047	VOLKSWAGEN	3AE827550A	ML6186	VOLKSWAGEN	701829331J	ML5247
VAUXHALL	90521517	ML5166	VOLKSWAGEN	3AF827550A	ML6187	VOLKSWAGEN	701829331Q	ML5249
VAUXHALL	90559245	ML5138	VOLKSWAGEN	3AF827550C	ML6187	VOLKSWAGEN	701829331R	ML5118
VAUXHALL	90579440	ML5137	VOLKSWAGEN	3B0823359	ML5266	VOLKSWAGEN	701829331S	ML5251
VAUXHALL	91168256	ML5516	VOLKSWAGEN	3B0823359A	ML5266	VOLKSWAGEN	7827550A	ML5644
VAUXHALL	93193385	ML5078	VOLKSWAGEN	3B0823359B	ML5266	VOLKSWAGEN	7D0823359A	ML6101
VAUXHALL	93193386	ML5078	VOLKSWAGEN	3B5827550	ML5135	VOLKSWAGEN	7H0823359A	ML5832
VAUXHALL	93386999	ML5119	VOLKSWAGEN	3B5827550A	ML5135	VOLKSWAGEN	7H0823359B	ML5832
VAUXHALL	93867088	ML6178	VOLKSWAGEN	3B5827550A	ML5193	VOLKSWAGEN	7H0823359C	ML5832
VAUXHALL	13270990246620	ML5408	VOLKSWAGEN	3B5827550C	ML5193	VOLKSWAGEN	7H0827550	ML5575
VOLKSWAGEN			VOLKSWAGEN	3B5827550E	ML5439	VOLKSWAGEN	7H0827550B	ML5576
VOLKSWAGEN	147827550	ML5572	VOLKSWAGEN	3B5827550G	ML5439	VOLKSWAGEN	7H0827550B	ML5833
VOLKSWAGEN	251829331	ML5645	VOLKSWAGEN	3B9827550	ML5185	VOLKSWAGEN	7H0827550C	ML5833
VOLKSWAGEN	251829332	ML5106	VOLKSWAGEN	3C0823359	ML5829	VOLKSWAGEN	7L6823359B	ML5357
VOLKSWAGEN	333827550	ML5123	VOLKSWAGEN	3C0823359A	ML5829	VOLKSWAGEN	7L6845587	ML5793
VOLKSWAGEN	533827550	ML5677	VOLKSWAGEN	3C5827550A	ML5830	VOLKSWAGEN	7L6845587A	ML5793
VOLKSWAGEN	867827550	ML5644	VOLKSWAGEN	3C5827550B	ML5830	VOLKSWAGEN	7M0823359G	ML5127
VOLKSWAGEN	1918827550	ML5574	VOLKSWAGEN	3C5827550C	ML5830	VOLKSWAGEN	7M0827550D	ML5127
VOLKSWAGEN	171827550A	ML5073	VOLKSWAGEN	3C8823359	ML6096	VOLKSWAGEN	7M0827550F	ML5127
VOLKSWAGEN	1918827550A	ML5038	VOLKSWAGEN	3C9827550	ML5831	VOLKSWAGEN	7M0827550G	ML5127
VOLKSWAGEN	1C0823359B	ML5393	VOLKSWAGEN	3C9827550A	ML5831	VOLKSWAGEN	7M3827550A	ML5480
VOLKSWAGEN	1C0823359C	ML5393	VOLKSWAGEN	3D0823359C	ML6097	VOLKSWAGEN	867827550C	ML5177
VOLKSWAGEN	1C0823359D	ML5393	VOLKSWAGEN	3D5827550B	ML6099	VOLKSWAGEN	867827550D	ML5178
VOLKSWAGEN	1C0827550A	ML5325	VOLKSWAGEN	3D5827550C	ML6098	VOLKSWAGEN	867827550E	ML5193
VOLKSWAGEN	1C0827550B	ML5325	VOLKSWAGEN	3D5827550F	ML5193	VOLKSWAGEN	8B5827550C	ML5193
VOLKSWAGEN	1C0827550C	ML5325	VOLKSWAGEN	3D5827552C	ML5193	VOLKSWAGEN	8D5827550F	ML5193
VOLKSWAGEN	1C0827550D	ML5325	VOLKSWAGEN	3G0823359	ML6365	VOLKSWAGEN	8D5827552C	ML5193
VOLKSWAGEN	1E0827550	ML5675	VOLKSWAGEN	3G0823359A	ML6365	VOLKSWAGEN	8J0823359	ML5261
VOLKSWAGEN	1E0827550B	ML5675	VOLKSWAGEN	3G0823359A	ML6365	VOLKSWAGEN	8J0823359A	ML5261
VOLKSWAGEN	1H5827550A	ML5226	VOLKSWAGEN	3G9827550A	ML6357	VOLKSWAGEN	8L0823359	ML5261
VOLKSWAGEN	1H5827550B	ML5226	VOLKSWAGEN	3G9827550B	ML6357	VOLKSWAGEN	8S0823359	ML6349
VOLKSWAGEN	1H6827550	ML5049	VOLKSWAGEN	533827550A	ML5677	VOLKSWAGEN	8S7827552A	ML6347
VOLKSWAGEN	1H6827550A	ML5049	VOLKSWAGEN	535827550A	ML5573	VOLKSWAGEN	8S8827552A	ML6346
VOLKSWAGEN	1H9827550A	ML5191	VOLKSWAGEN	5C3827550	ML6326	VOLKSWAGEN	C160419	ML6329
VOLKSWAGEN	1J0823359	ML5261	VOLKSWAGEN	5C6827550	ML6247	VOLKSWAGEN	STRTO017	ML6328
VOLKSWAGEN	1J0823359C	ML5264	VOLKSWAGEN	5G0823359	ML6221	VOLVO		
VOLKSWAGEN	1J6827550	ML5132	VOLKSWAGEN	5G6827550D	ML6220	VOLVO	180084	ML6090
VOLKSWAGEN	1J6827550C	ML5132	VOLKSWAGEN	5G9827550	ML6327	VOLVO	819865	ML5368
VOLKSWAGEN	1J9827550	ML5132	VOLKSWAGEN	5K0823359D	ML5648	VOLVO	1334648	ML5906
VOLKSWAGEN	1K0823359A	ML5735	VOLKSWAGEN	5K6827550B	ML5653	VOLVO	1355263	ML5312
VOLKSWAGEN	1K5827550C	ML5751	VOLKSWAGEN	5M0827550	ML5792	VOLVO	1376115	ML6090
VOLKSWAGEN	1K6827550D	ML5742	VOLKSWAGEN	5M0827550A	ML5792	VOLVO	3344245	ML5642
VOLKSWAGEN	1K6827550E	ML5742	VOLKSWAGEN	5N0827550A	ML5838	VOLVO	3436644	ML5509
VOLKSWAGEN	1K6827550F	ML5742	VOLKSWAGEN	5Z6827550B	ML5796	VOLVO	3436644	ML5571
VOLKSWAGEN	1K8827550A	ML6100	VOLKSWAGEN	6E0823359E	ML5287	VOLVO	3470348	ML5571
VOLKSWAGEN	1K9827550A	ML5754	VOLKSWAGEN	6E0827550B	ML5199	VOLVO	3470350	ML5509
VOLKSWAGEN	1Q0823359	ML5738	VOLKSWAGEN	6E0827550C	ML5195	VOLVO	3470350	ML5571
VOLKSWAGEN	1Q0827550A	ML5752	VOLKSWAGEN	6K0827550	ML5100	VOLVO	3509482	ML5529
VOLKSWAGEN	1Q0827550B	ML5752	VOLKSWAGEN	6K0827550A	ML5100	VOLVO	3512998	ML5840
VOLKSWAGEN	1S6827550D	ML6189	VOLKSWAGEN	6K5827550A	ML5063	VOLVO	3526575	ML5347
VOLKSWAGEN	1T0823359	ML5736	VOLKSWAGEN	6K5827550C	ML5259	VOLVO	3529925	ML5348
VOLKSWAGEN	1T0823359A	ML5736	VOLKSWAGEN	6N0823359	ML5265	VOLVO	6846014	ML5312
VOLKSWAGEN	1T0823359D	ML6152	VOLKSWAGEN	6N0827550A	ML5145	VOLVO	8600233	ML5481
VOLKSWAGEN	1T0827550A	ML5743	VOLKSWAGEN	6Q0823359	ML5491	VOLVO	8650233	ML5481
VOLKSWAGEN	1T0827550B	ML5743	VOLKSWAGEN	6Q0823359A	ML5491	VOLVO	9154605	ML5643
			VOLKSWAGEN	6Q5827550A	ML5748	VOLVO	9159604	ML5909

OE CROSS LIST

MONROE® MAX-LIFT® OE CROSS REFERENCE LIST

 OE N°:	Ref.	 OE N°:	Ref.	 OE N°:	Ref.
VOLVO	9159605	ML5909			
VOLVO	9187315	ML5529			
VOLVO	9187795	ML5909			
VOLVO	9187796	ML5909			
VOLVO	9483297	ML5489			
VOLVO	9483299	ML5489			
VOLVO	9483570	ML5726			
VOLVO	9485546	ML5909			
VOLVO	9485547	ML5909			
VOLVO	9485548	ML5529			
VOLVO	9485706	ML5487			
VOLVO	30634580	ML5427			
VOLVO	30649439	ML5490			
VOLVO	30649516	ML5663			
VOLVO	30649736	ML5361			
VOLVO	30649836	ML6091			
VOLVO	30657235	ML5907			
VOLVO	30674203	ML5488			
VOLVO	30674494	ML5685			
VOLVO	30674718	ML5500			
VOLVO	30674836	ML6092			
VOLVO	30674971	ML5488			
VOLVO	30716189	ML5500			
VOLVO	30779837	ML6091			
VOLVO	30784935	ML6136			
VOLVO	30803472	ML5184			
VOLVO	30852059	ML5154			
VOLVO	30852060	ML5154			
VOLVO	31217640	ML6092			
VOLVO	31217910	ML6223			
VOLVO	31218478	ML5726			
VOLVO	31278323	ML5907			
VOLVO	31278769	ML6222			
VOLVO	31297080	ML6223			
VOLVO	31297524	ML6224			
VOLVO	31298282	ML6254			
VOLVO	31333127	ML6246			
VOLVO	31335392	ML6224			
VOLVO	31335795	ML6094			
ZASTAVA					
ZASTAVA	46622166	ML5097			
ZASTAVA	46635997	ML5008			
ZASTAVA	46636020	ML5028			
ZASTAVA	46636021	ML5028			
ZASTAVA	46636022	ML5029			
ZAZ					
ZAZ	126308506	ML5115			
ZAZ	136308506	ML5035			
ZAZ	1216308506	ML5072			
ZAZ	1326308506	ML5116			
ZAZ	11026308016	ML5035			

MONROE® MAX-LIFT® CROSS REFERENCE LIST

STABILUS

STABILUS	MONROE®	STABILUS	MONROE®	STABILUS	MONROE®	STABILUS	MONROE®	STABILUS	MONROE®
000922	ML6144	017120	ML6014	024395	ML5276	113057	ML5766	292315	ML6361
001825	ML5806	017203	ML5667	024409	ML5740	113057	ML6004	298768	ML6362
001984	ML5727	017353	ML5793	024452	ML5959	113559	ML6079	303316	ML5202
002001	ML5728	017448	ML6081	024473	ML6100	115208	ML6004	304490	ML5536
002433	ML5309	017451	ML6080	024477	ML6066	116642	ML6218	305706	ML5517
002578	ML6143	017467	ML5342	024485	ML6047	118339	ML6103	308105	ML6063
005190	ML5205	017468	ML5219	024559	ML5746	123804	ML5945	312136	ML6228
006950	ML5987	017468	ML5221	026209	ML6102	124051	ML6102	313813	ML6239
008472	ML5637	017667	ML5325	026247	ML5235	125238	ML6230	317446	ML5628
008528	ML5259	017688	ML6145	026247	ML5236	127628	ML5944	318116	ML5593
011499	ML5692	017706	ML5779	026247	ML5451	130257	ML6116	318126	ML6214
011532	ML5976	017971	ML6086	026251	ML6016	130496	ML6117	318851	ML6099
011591	ML5782	018094	ML5278	026825	ML5687	133365	ML6230	319792	ML6197
011864	ML5484	018123	ML5194	026872	ML5430	135276	ML5999	319816	ML6244
011934	ML6195	018254	ML5701	027536	ML6216	136715	ML6134	322835	ML6247
012074	ML5330	018271	ML5354	027594	ML5295	138383	ML5997	326956	ML5505
012111	ML5702	018306	ML5217	029111	ML6286	140794	ML5827	331280	ML6335
012124	ML5784	018318	ML6022	031139	ML5681	141033	ML6362	333859	ML5676
012129	ML5141	018329	ML5757	031370	ML6091	141989	ML5807	341298	ML6073
012144	ML5664	018376	ML5185	031543	ML5958	142228	ML6361	341452	ML6090
012158	ML5288	018382	ML5764	031543	ML5958	151314	ML6353	343477	ML6125
012180	ML5703	018471	ML5836	031675	ML6016	151560	ML5777	347273	ML6130
012551	ML5233	018494	ML5787	031861	ML6198	153440	ML5946	348944	ML6035
012552	ML5232	018560	ML5317	031902	ML5404	155830	ML6112	351097	ML6132
012559	ML5824	018560	ML5318	031974	ML6082	165398	ML6152	360428	ML6286
012604	ML5514	018565	ML5193	031997	ML5797	166115	ML6216	361864	ML6304
012809	ML5687	018616	ML5284	032002	ML6253	167071	ML6245	364732	ML6272
013177	ML5790	018629	ML5768	032177	ML6092	167573	ML5923	369990	ML6279
013258	ML5514	018642	ML6121	032436	ML5439	167812	ML5918	370468	ML6273
013349	ML5716	018746	ML5199	032455	ML5930	176631	ML6247	370468	ML6278
013621	ML6002	018756	ML5449	032492	ML6083	178797	ML6254	371025	ML5594
013902	ML6009	018816	ML5687	032492	ML6083	188579	ML6029	376132	ML5074
014169	ML6047	018816	ML6151	032622	ML5704	189535	ML6027	385040	ML6311
014203	ML6303	019830	ML5747	032622	ML6066	192856	ML5546	385302	ML5724
015058	ML6338	019830	ML5979	033035	ML5457	193359	ML6310	386469	ML6201
015277	ML5214	019872	ML6108	033044	ML5515	194000	ML5087	387683	ML6360
015277	ML5405	020282	ML5133	033330	ML6280	194001	ML5098	388387	ML6210
015381	ML5453	020353	ML5958	033509	ML6016	194003	ML5405	389104	ML6291
015489	ML5485	020594	ML5227	033509	ML6016	194007	ML5157	391494	ML6284
015491	ML5666	020666	ML6152	033839	ML5805	196943	ML6284	395340	ML6075
015495	ML5699	020878	ML5745	033965	ML5180	200065	ML6322	397013	ML6233
015496	ML5699	022244	ML5696	033965	ML5426	200304	ML6322	400574	ML6290
015517	ML5121	022245	ML5164	034056	ML6097	205791	ML6194	407529	ML5021
015523	ML5963	022386	ML5165	034116	ML6146	238763	ML6123	419240	ML6128
015523	ML6087	022528	ML5968	034491	ML5088	239002	ML5962	421144	ML5459
015526	ML5963	022818	ML5775	034491	ML6044	239719	ML5961	421622	ML5460
015531	ML6089	022869	ML6003	034830	ML6129	239958	ML5967	422817	ML6367
015582	ML5358	022885	ML5921	035075	ML5928	245887	ML6060	426171	ML5101
015583	ML5183	023093	ML5920	035852	ML6246	246658	ML6205	434042	ML6350
015621	ML5536	023216	ML5975	037070	ML6097	246897	ML6204	437135	ML6092
016391	ML5353	023234	ML5977	053414	ML5625	248169	ML5625	439545	ML6244
016393	ML5288	023247	ML5228	055469	ML5309	248223	ML5364	440017	ML6351
016476	ML5261	023549	ML5277	060984	ML5613	248594	ML5511	442407	ML6348
016476	ML5284	023555	ML5234	067405	ML6349	249270	ML5635	444413	ML5607
016501	ML6009	023557	ML5746	069073	ML5358	249653	ML5585	449482	ML5607
016533	ML6285	023581	ML5459	069793	ML6287	253154	ML5497	450189	ML5934
016561	ML5214	023581	ML5460	074816	ML6027	254071	ML6196	451737	ML6358
016570	ML5500	023592	ML5198	078405	ML6220	263385	ML6194	456737	ML6312
016618	ML6083	023606	ML5238	079361	ML6290	263392	ML6277	461083	ML5605
016677	ML5496	023606	ML5240	082414	ML5629	266505	ML6352	463425	ML6133
016721	ML5175	023619	ML5924	083674	ML5024	273673	ML6328	463455	ML6191
016738	ML5195	023713	ML5749	083798	ML5632	273689	ML5704	465240	ML5556
016738	ML5284	023812	ML5269	086531	ML6221	274038	ML5293	467015	ML6193
016761	ML5765	023812	ML5269	093380	ML6000	274186	ML5286	468210	ML6192
016767	ML5672	023819	ML5269	093946	ML6292	277003	ML6240	468449	ML6226
016797	ML5672	023895	ML6078	105409	ML5448	283576	ML5452	498563	ML6166
016841	ML5553	023945	ML5449	105433	ML5744	285866	ML6289	498588	ML5963
016846	ML6078	023967	ML5239	105672	ML5926	291668	ML5177	499514	ML6110
016943	ML6332	024208	ML5386	105911	ML5925	291722	ML5073	499783	ML5940
016954	ML5357	024263	ML5927	106867	ML5665	291870	ML5677	512182	ML5427
016955	ML5393	024284	ML5929	107345	ML6096	291919	ML5106	512182	ML5489
016980	ML6008	024295	ML5739	109735	ML5922	291927	ML5645	513884	ML5369
016990	ML5763	024335	ML5370	110189	ML5729	291935	ML5645	515053	ML6291
016994	ML5145	024339	ML5679	112597	ML6330	292257	ML5677	515061	ML6281

CROSS LIST

MONROE® MAX-LIFT® CROSS REFERENCE LIST

STABILUS

STABILUS	MONROE®	STABILUS	MONROE®	STABILUS	MONROE®	STABILUS	MONROE®	STABILUS	MONROE®
520547	ML6253	688711	ML5525	873790	ML6127	8162057	ML6211	0704VJ	ML5932
521503	ML6022	705084	ML5950	874029	ML6074	8163477	ML6240	0707VV	ML5695
522010	ML5391	712224	ML5766	875221	ML5936	8163479	ML6239	0714FN	ML5093
522459	ML6022	712941	ML6319	877620	ML6202	8166766	ML6213	0727PG	ML5163
522459	ML6023	713210	ML6060	878821	ML6300	8169710	ML6241	0744VM	ML5693
524085	ML5065	717721	ML6122	881227	ML5162	8172927	ML6233	0744VV	ML5564
524371	ML5160	720826	ML6049	883589	ML5939	8172965	ML6214	0745VH	ML5565
527971	ML5320	723700	ML6335	883589	ML6046	8172967	ML6242	0751VQ	ML5720
529393	ML6032	724904	ML5384	884302	ML6241	8175722	ML6209	0752VQ	ML5669
536325	ML6220	726084	ML6051	887064	ML5020	8175724	ML6234	0755VB	ML5088
537288	ML6359	732061	ML6142	890146	ML5505	8175727	ML6207	0756VX	ML5721
540866	ML5753	732300	ML6141	895534	ML5461	8182922	ML6216	0759VI	ML5817
543968	ML5488	732539	ML6224	896251	ML5862	8182924	ML6245	0762VK	ML5213
545879	ML6236	732778	ML6055	900337	ML6200	8185714	ML6218	0763VF	ML5562
547313	ML6234	733495	ML6108	905596	ML6356	8188923	ML6219	0772VE	ML5769
557757	ML5549	734688	ML6053	907517	ML6058	8195078	ML6220	0786FP	ML5144
559502	ML6039	739231	ML6224	907985	ML6339	8195079	ML6247	0789FA	ML5242
563092	ML6288	741173	ML5503	909658	ML6364	8195834	ML6224	0789PO	ML5759
565969	ML6199	741412	ML5203	915467	ML5133	8195835	ML6246	0792FC	ML5054
567869	ML6254	741412	ML5204	917077	ML5948	8195837	ML6223	0793KE	ML5368
568598	ML6250	741412	ML5503	917284	ML5588	8357890	ML6221	0813MK	ML5226
571943	ML6213	745953	ML6190	919216	ML6343	0008SX	ML5206	0818MM	ML5239
572907	ML6365	746659	ML6317	919917	ML6135	0008SX	ML5207	0818MM	ML5241
573146	ML6357	759786	ML6105	924464	ML6203	0009DY	ML5367	0823NA	ML5129
583169	ML6219	760579	ML5313	925181	ML6232	0026DA	ML5258	0833HS	ML5436
583880	ML5568	760982	ML6206	925188	ML6340	0028DR	ML5032	0869SH	ML6138
584122	ML6289	762194	ML6318	926850	ML5577	0031DT	ML5077	0872NC	ML5909
585314	ML5589	762672	ML6318	929005	ML6255	0046SJ	ML5703	0885SP	ML6137
586044	ML6215	763867	ML6326	934259	ML5560	0081FI	ML5065	0895QR	ML5705
591505	ML5133	764331	ML6207	935215	ML6032	0098IZ	ML5411	0933SV	ML5702
592484	ML5382	766718	ML5943	940151	ML5505	0101IK	ML5452	0953VY	ML5805
592484	ML5660	770302	ML6106	940716	ML6235	0126IA	ML5549	0955HQ	ML5136
593440	ML5993	772928	ML6217	945033	ML6366	0174HL	ML5541	0955QH	ML5394
593440	ML6169	779623	ML6329	946919	ML5954	0187SA	ML5119	0955QH	ML5434
593932	ML6363	782265	ML6346	947656	ML6342	0197IH	ML5269	0974DZ	ML6040
595832	ML5811	783925	ML6120	948134	ML6342	0224DX	ML5260	0999MG	ML5675
598490	ML6225	789011	ML5359	962454	ML5990	0244HW	ML5336	0999RN	ML5828
603538	ML5601	791148	ML5192	973698	ML6242	0259LC	ML5265	1026AW	ML5273
604434	ML6226	793159	ML5431	996870	ML6113	0261PU	ML6146	1035VA	ML5938
604673	ML6192	798436	ML5282	997620	ML6337	0261QQ	ML5564	1036VW	ML5690
605636	ML5813	798444	ML5139	7172968	ML6244	0262QL	ML5564	1041VO	ML5688
608020	ML6136	798444	ML5598	8000707	ML6191	0287QB	ML5631	1043AX	ML5919
610893	ML6210	810722	ML6115	8004228	ML6193	0288RT	ML5799	1047VL	ML5763
611843	ML5941	815357	ML5457	8017000	ML6250	0292IZ	ML5325	1057VF	ML5763
611844	ML5941	818341	ML6072	8017001	ML6198	0316QO	ML5800	1087PL	ML5370
611845	ML6111	819297	ML6071	8017002	ML6199	0319VG	ML5699	1114WG	ML5749
612084	ML5995	820014	ML5998	8041406	ML6205	0321VN	ML5699	1121FC	ML5974
612323	ML5613	826724	ML6355	8066705	ML6253	0325VU	ML5699	1128SX	ML5481
612801	ML6227	831028	ML6354	8069700	ML6251	0326VP	ML5699	1128TT	ML5366
613757	ML6107	831891	ML5094	8072904	ML6215	0406IS	ML5312	1152RM	ML5168
618101	ML5013	835789	ML6202	8082904	ML6217	0421NL	ML5672	1154PK	ML6004
619016	ML5991	836506	ML6135	8095021	ML6221	0421VG	ML5530	1179KU	ML5499
619701	ML5677	837458	ML5104	8095808	ML6222	0424HU	ML5235	1186KC	ML5126
622601	ML5992	844392	ML5947	8095809	ML6254	0427HF	ML5235	1186KC	ML5176
627141	ML6030	848473	ML6336	8100725	ML6190	0438NY	ML5809	1187KY	ML5176
630021	ML6327	848581	ML5255	8104249	ML6227	0442NV	ML5809	1193RK	ML5198
630499	ML6321	848794	ML5255	8104255	ML6226	0482RI	ML5773	1194SB	ML5744
630738	ML6320	852518	ML6012	8104256	ML6192	0488KG	ML5127	1196MP	ML5061
633832	ML5445	853474	ML6013	8104259	ML6225	0512RQ	ML5345	1207QO	ML5295
639079	ML5202	853489	ML6349	8108434	ML6194	0519FC	ML5178	1255RR	ML5309
643869	ML6094	853728	ML6347	8114210	ML6228	0542SV	ML5443	1262MT	ML6065
643870	ML6094	855879	ML6346	8114901	ML6195	0552TL	ML5786	1272PB	ML5297
645309	ML6240	857270	ML5315	8115661	ML6196	0591PI	ML5186	1275PN	ML5167
645548	ML6239	857547	ML6347	8115662	ML6197	0593PZ	ML5561	1276PI	ML5569
648416	ML6211	859060	ML5384	8117003	ML6200	0596PK	ML6147	1277PD	ML5710
656267	ML5617	859486	ML5825	8126154	ML6201	0623BI	ML5253	1293BN	ML5846
662764	ML6305	865670	ML6223	8127578	ML6202	0624KV	ML5184	1295BD	ML5142
671363	ML5306	866626	ML6246	8137243	ML6203	0644PQ	ML5577	1299KB	ML5238
673274	ML6365	867582	ML6222	8137244	ML6232	0645PL	ML5560	1308PG	ML5137
673986	ML5040	867588	ML5343	8141407	ML6204	0648KQ	ML5398	1311PI	ML5257
673986	ML5112	867843	ML5733	8144235	ML6236	0681VK	ML5563	1313WY	ML5443
686352	ML5208	869505	ML6344	8144236	ML6236	0685VR	ML5691	1325BL	ML5210
686360	ML5208	870950	ML5956	8144240	ML6206	0691QY	ML5453	1358RW	ML5696
686360	ML5209	873072	ML6011	8156831	ML6210	0698WT	ML6141	1381MF	ML5263

MONROE® MAX-LIFT® CROSS REFERENCE LIST

STABILUS

STABILUS	MONROE®	STABILUS	MONROE®	STABILUS	MONROE®	STABILUS	MONROE®	STABILUS	MONROE®
1386BY	ML5111	2211NP	ML5389	3235YM	ML5508	4751SB	ML5789	6325MI	ML5544
1386BY	ML6269	2232KK	ML5642	3261XS	ML5817	4756UW	ML5779	6331QG	ML5269
1387BT	ML5420	2239NR	ML5164	3269YB	ML6037	4839QB	ML5194	6341NM	ML5068
1393BG	ML5417	2254ND	ML5198	3271YI	ML6036	4839QB	ML5196	6345QH	ML5817
1405BQ	ML5376	2261NM	ML5449	3277YF	ML5352	4927UV	ML5687	6362LD	ML5128
1406BL	ML5104	2266UN	ML6150	3278YA	ML5996	4927UV	ML6151	6364LU	ML5086
1431EG	ML5098	2268FJ	ML5517	3286UU	ML5729	4932SV	ML5425	6371SB	ML5782
1431EG	ML6140	2275TQ	ML5722	3289YQ	ML5371	4953PQ	ML5223	6371SB	ML5824
1464BM	ML5596	2282NW	ML5150	3293GE	ML5441	4958SG	ML5151	6389PV	ML5491
1477MB	ML5259	2282NW	ML5152	3293UH	ML5664	5001ZR	ML5737	6391PB	ML5181
1492RV	ML5297	2283NR	ML5130	3309RE	ML5764	5011ZL	ML5744	6402QM	ML5526
1492RV	ML5616	2291TY	ML5744	3339FH	ML5430	5037SY	ML5377	6415VW	ML5723
1493RQ	ML6341	2315TS	ML5749	3348SI	ML5757	5044SG	ML5377	6443BA	ML5031
1494RL	ML5994	2334BC	ML5421	3354SW	ML5757	5056KW	ML5183	6456QQ	ML5224
1501RT	ML5759	2335QS	ML5154	3401UZ	ML5727	5073BH	ML5338	6459QB	ML5467
1513BN	ML5600	2417BT	ML5249	3402UU	ML5727	5086PL	ML5404	6467QF	ML5169
1516RP	ML5707	2426FC	ML5069	3425VQ	ML6330	5114PC	ML5351	6471QC	ML5558
1517RK	ML5711	2442PY	ML5179	3442UX	ML5416	5126VQ	ML5699	6471QC	ML5637
1525QS	ML5380	2446TP	ML5248	3445FO	ML5261	5132VD	ML5699	6472QY	ML5558
1529QZ	ML5570	2446YW	ML6006	3466PL	ML5688	5146ZP	ML5488	6473QT	ML5349
1535NY	ML5370	2449RI	ML5782	3474XK	ML5577	5197IV	ML5217	6473QT	ML5375
1559BN	ML5573	2449RI	ML5824	3477XW	ML5560	5204PB	ML5448	6473QT	ML5402
1567RH	ML5720	2474LM	ML5161	3489US	ML5806	5226IH	ML5215	6474QO	ML5397
1568TV	ML5693	2479LO	ML6076	3493UP	ML5806	5253VG	ML5699	6479HZ	ML5622
1575BV	ML5934	2486ZV	ML5665	3587SC	ML5044	5262VF	ML5699	6482HA	ML5078
1585BP	ML5422	2487ZQ	ML5665	3592SV	ML5826	5279QL	ML5766	6492TA	ML5727
1588QV	ML5068	2512WH	ML5459	3658XP	ML6101	5336XP	ML5742	6518NI	ML5439
1592BY	ML5019	2515TE	ML6083	3749WN	ML5809	5353SL	ML5789	6539NS	ML5185
1598PT	ML5412	2524BV	ML6020	3781WC	ML5809	5354SG	ML5799	6541LG	ML5131
1617MX	ML5640	2554NJ	ML5121	3789WQ	ML5809	5371ZI	ML5269	6543LX	ML5131
1628NI	ML6173	2558NQ	ML5121	3796WZ	ML5809	5394WU	ML6330	6543NP	ML5199
1646NG	ML5277	2567YZ	ML6209	3798NY	ML5134	5399SL	ML5345	6553NJ	ML5264
1699NP	ML5514	2569LN	ML5138	3915PL	ML5511	5414ZW	ML5740	6553VE	ML5807
1708TQ	ML5460	2572WZ	ML5552	3917NJ	ML5393	5424QZ	ML5728	6556YE	ML5784
1718NH	ML5511	2574WP	ML5828	3935ZN	ML5225	5427ZB	ML5737	6559YQ	ML5784
1757VK	ML5717	2574YH	ML6209	3937AM	ML5649	5435DM	ML5317	6566PH	ML5623
1758VF	ML5717	2575WK	ML6131	3958IA	ML5529	5435ZF	ML5739	6576TM	ML5374
1759VA	ML5717	2575YC	ML6233	3975FP	ML5637	5449ZG	ML5745	6584WE	ML5699
1765QH	ML5699	2576WF	ML5131	3976SM	ML5215	5454ZZ	ML6104	6591WN	ML5564
1773MA	ML6043	2584WJ	ML5789	3987SB	ML5687	5537SQ	ML5703	6597DF	ML5553
1793BF	ML5286	2586XW	ML5746	3987SB	ML5730	5538SL	ML5702	6604PT	ML5475
1794BA	ML5286	2614KL	ML5166	3995SF	ML5687	5561UU	ML5742	6615PI	ML5826
1796BR	ML5980	2616BK	ML6031	3995SF	ML6151	5563IT	ML5506	6624PH	ML5826
1800BN	ML5981	2639KB	ML5120	4012LQ	ML5690	5593MY	ML5124	6642PF	ML5340
1806BK	ML5171	2696LD	ML5135	4013WV	ML5391	5642ZA	ML6042	6648HH	ML5228
1807BF	ML5172	2697LZ	ML5135	4027CV	ML5276	5705XK	ML5223	6649LN	ML5353
1808BA	ML5172	2699UG	ML5744	4038KF	ML5195	5705XK	ML5234	6707DS	ML5375
1814AT	ML5081	2705RE	ML5800	4039KA	ML5132	5724ZW	ML5416	6707DS	ML5402
1815BJ	ML5463	2745GY	ML5624	4044WZ	ML5718	5725ZR	ML5786	6711TF	ML6027
1819BQ	ML5252	2765UK	ML5107	4045WU	ML5718	5768ZF	ML5685	6714DA	ML5434
1820BB	ML5109	2765UK	ML5299	4047NT	ML5343	5783VH	ML5786	6736AR	ML5347
1873TT	ML5803	2827RC	ML5721	4081FD	ML5428	5806SS	ML5828	6740AO	ML5348
1875DT	ML5426	2864UI	ML5780	4126XQ	ML5564	5821PQ	ML5467	6843RF	ML5773
1913YB	ML5701	2874GE	ML5257	4147PE	ML5432	5836DG	ML6148	6857LD	ML5217
1962RE	ML5459	2877GQ	ML5085	4173XB	ML5439	5904QC	ML5382	6858GS	ML5076
1975BU	ML5429	2894RC	ML5616	4209AR	ML5143	5904QC	ML5660	6886YT	ML5726
1976BP	ML5429	2937ZL	ML5836	4214PD	ML5790	5905QY	ML5823	6914LI	ML5148
1979BA	ML5080	2958GQ	ML5624	4227MV	ML6366	5913QB	ML5814	6927GH	ML5292
1986BJ	ML5294	2988TA	ML5394	4238RR	ML5357	6022MR	ML6019	6927TJ	ML5817
1987BE	ML5293	3011XI	ML5836	4249RG	ML5769	6024MH	ML5484	6936AD	ML5312
1990BG	ML5080	3061KD	ML5375	4279NE	ML5270	6052CM	ML5079	6952TQ	ML5689
1996BD	ML5612	3062KZ	ML5375	4348MY	ML5342	6054BG	ML5049	7017TQ	ML5281
1997BZ	ML5110	3063KU	ML5402	4411IF	ML5234	6061CL	ML5540	7021TN	ML5038
1998BU	ML5110	3121TL	ML5747	4412ML	ML5193	6062SX	ML5379	7022TI	ML5280
2001BC	ML5611	3146ZE	ML5704	4473PM	ML5227	6108DB	ML5494	7026LU	ML5013
2008BV	ML5200	3158TM	ML5164	4495VU	ML5718	6124QL	ML5687	7041MC	ML5787
2008BV	ML5201	3161YV	ML5809	4535VW	ML5746	6124QL	ML5730	7042MY	ML5787
2010BB	ML5201	3168YN	ML5809	4546NQ	ML5768	6181SJ	ML5793	7043MT	ML5787
2012BS	ML5463	3169SF	ML5288	4636II	ML5308	6241QH	ML5186	7098VJ	ML5826
2012BS	ML5464	3169SF	ML6109	4645NO	ML5218	6241QH	ML5187	7187VN	ML5475
2014BI	ML5023	3187BR	ML5043	4656NO	ML5218	6266QY	ML5552	7189MM	ML5233
2038YT	ML5753	3211CY	ML5146	4711UR	ML5765	6304NV	ML5330	7209HT	ML5303
2048RO	ML5637	3211CY	ML5316	4742NW	ML5203	6315NK	ML5514	7266HZ	ML5140
2065BA	ML5973	3216KV	ML6033	4742NW	ML5204	6324LR	ML5224	7282MN	ML5240

MONROE® MAX-LIFT® CROSS REFERENCE LIST

STABILUS

STABILUS	MONROE®	STABILUS	MONROE®	STABILUS	MONROE®	STABILUS	MONROE®	STABILUS	MONROE®
7303DE	ML5016	7906GQ	ML5271	8468UW	ML5811	9005XA	ML5810	9427NR	ML5251
7303DE	ML5039	7945HU	ML5457	8478CH	ML5118	9006XW	ML5810	9429IA	ML5217
7374AL	ML5408	7958RN	ML5212	8481CJ	ML5249	9046BF	ML5243	9434HX	ML5520
7377TN	ML5709	7959RI	ML5340	8482TR	ML5729	9084XL	ML6015	9455ES	ML5445
7378RQ	ML5699	7969MW	ML5175	8484CV	ML5251	9106RM	ML5804	9466IS	ML5217
7378TI	ML5706	7998TI	ML5695	8487UP	ML5799	9153KZ	ML5811	9468II	ML5185
7385RZ	ML5699	8014RE	ML5986	8491UM	ML6021	9168MN	ML5219	9494KC	ML5674
7388RK	ML5699	8047NO	ML5386	8498UE	ML5798	9169MI	ML5220	9517HN	ML5328
7441FC	ML5228	8082YZ	ML6149	8512CM	ML5176	9171HI	ML5423	9517HN	ML5621
7441FC	ML5229	8083GL	ML5471	8514CC	ML5126	9171MP	ML5221	9568UH	ML5745
7443NO	ML5063	8123DZ	ML5323	8516CT	ML5290	9213WV	ML5773	9572UE	ML5745
7456RE	ML5729	8127KE	ML5437	8518CJ	ML5431	9219XO	ML5729	9582RK	ML5120
7469HX	ML5424	8139HA	ML5365	8523CB	ML5332	9228UZ	ML5827	9588FB	ML5103
7509HZ	ML5093	8166CR	ML5311	8534TD	ML5415	9231BW	ML5362	9589NS	ML5481
7557HF	ML5314	8203KC	ML5216	8539UB	ML5804	9234HK	ML5236	9605KK	ML5325
7587GS	ML5321	8205TK	ML5763	8541UI	ML5803	9234HK	ML5260	9618PX	ML5699
7609LC	ML5217	8218TQ	ML5763	8542CV	ML5333	9247ZZ	ML5427	9632TZ	ML5737
7628LW	ML5185	8235LY	ML5536	8542UD	ML6069	9249HG	ML5436	9639BI	ML5244
7629LR	ML5191	8242LG	ML5536	8546CB	ML5573	9254KN	ML5284	9639UN	ML5813
7631LY	ML5275	8254BD	ML5023	8551UC	ML5808	9262QU	ML5824	9643XZ	ML5414
7638NI	ML5481	8306BQ	ML5418	8552UY	ML6067	9262UE	ML5810	9653HC	ML5399
7656WY	ML5359	8310BN	ML5143	8584YH	ML6092	9267UG	ML5810	9668DO	ML5354
7691RP	ML5469	8311BI	ML5147	8613YU	ML5827	9272DM	ML5617	9669ZC	ML5689
7724AL	ML5546	8312BD	ML5388	8628YQ	ML6057	9274NT	ML5269	9673HR	ML5526
7734WM	ML5774	8322RO	ML5205	8637YP	ML5807	9278HU	ML5451	9677NA	ML5414
7739HU	ML5327	8337BU	ML5395	8642FC	ML5236	9288TU	ML5728	9714UQ	ML5777
7744HM	ML5315	8342BM	ML5408	8704YO	ML5777	9338XA	ML5341	9716UG	ML5777
7762HK	ML5319	8345BY	ML5527	8711TQ	ML5779	9338XA	ML5773	9759IP	ML5284
7764HA	ML5180	8345BY	ML5585	8715YD	ML5777	9339XW	ML5345	9767FE	ML5686
7818TJ	ML5692	8345BY	ML5586	8722BX	ML5594	9341XC	ML6005	9786CJ	ML5094
7819BW	ML5041	8355KJ	ML5442	8732ZC	ML6243	9342BE	ML5495	9789CV	ML5256
7824VP	ML5805	8358KV	ML5392	8771TH	ML5764	9344BV	ML5557	9829NG	ML5213
7825VK	ML5722	8404DL	ML5593	8884HA	ML5450	9345BQ	ML5557	9832NI	ML5163
7835BD	ML6309	8413HV	ML5197	8899NR	ML5225	9349XQ	ML5817	9842NC	ML5263
7856RD	ML5355	8429CF	ML5246	8926CM	ML5278	9351XX	ML5723	9914WV	ML5809
7857RZ	ML5334	8432CH	ML5245	8927UQ	ML6068	9354BP	ML5586	9968GI	ML5266
7858RU	ML5356	8443BA	ML5505	8982NG	ML5343	9365BE	ML5595	9991IR	ML5558
7861DY	ML5145	8451RV	ML5309	8985BM	ML5835	9368BQ	ML6251		
7865TV	ML5826	8453BV	ML5407	8986IG	ML5435	9369BL	ML6251		
7868TG	ML5475	8453CR	ML5247	8986TQ	ML5800	9371BS	ML5676		
7893HH	ML5326	8456LU	ML5643	8999NT	ML6099	9378KB	ML6062		
7901GO	ML5068	8467UA	ML5800	9003NX	ML6098	9391KY	ML6032		

LESJOFORS

LESJOFORS	MONROE®	LESJOFORS	MONROE®	LESJOFORS	MONROE®	LESJOFORS	MONROE®	LESJOFORS	MONROE®
8000700	ML5919	8004225	ML5739	8008420	ML6142	8041406	ML6205	8056829	ML6311
8000701	ML5608	8004226	ML6107	8008424	ML6333	8042101	ML6000	8058500	ML6033
8000702	ML5392	8004227	ML6108	8008427	ML6111	8042102	ML5999	8058700	ML5564
8000703	ML5414	8004228	ML6193	8014200	ML5939	8042103	ML5997	8058701	ML6037
8000704	ML5696	8004229	ML6106	8014201	ML6294	8044200	ML5706	8062000	ML5624
8000705	ML5697	8004231	ML6349	8014900	ML5945	8044201	ML5705	8063402	ML5085
8000706	ML6138	8004232	ML6284	8015600	ML5457	8044206	ML6342	8063403	ML5345
8000707	ML6191	8008400	ML5596	8015601	ML5270	8056800	ML5102	8063404	ML5720
8004200	ML5593	8008401	ML5421	8015602	ML5262	8056802	ML5438	8063405	ML6046
8004201	ML5333	8008402	ML5599	8015603	ML5461	8056803	ML5308	8063406	ML6049
8004206	ML5420	8008403	ML5522	8015604	ML5822	8056804	ML5309	8066700	ML5583
8004209	ML5679	8008404	ML5600	8017000	ML6250	8056805	ML5559	8066701	ML5470
8004210	ML5261	8008405	ML5566	8017002	ML6199	8056806	ML5577	8066702	ML5267
8004210	ML5729	8008406	ML5441	8026100	ML5038	8056807	ML5560	8066703	ML5788
8004212	ML5678	8008407	ML5422	8026102	ML5389	8056808	ML6024	8066705	ML6253
8004213	ML5135	8008408	ML5336	8026103	ML5976	8056809	ML6025	8069701	ML5730
8004214	ML5266	8008409	ML5263	8026104	ML6281	8056811	ML6032	8069702	ML5676
8004215	ML5276	8008410	ML5688	8027500	ML5292	8056812	ML5798	8069703	ML6147
8004216	ML5386	8008412	ML5563	8027501	ML5330	8056813	ML5799	8069704	ML5803
8004217	ML5269	8008413	ML5689	8027503	ML6358	8056814	ML6029	8069705	ML6069
8004218	ML5737	8008414	ML5562	8037200	ML5382	8056822	ML5811	8069706	ML6062
8004220	ML5741	8008415	ML5932	8037201	ML5660	8056824	ML6026	8069707	ML6319
8004221	ML5924	8008416	ML5565	8037202	ML5660	8056825	ML6027	8072902	ML6074
8004222	ML5740	8008417	ML5769	8037206	ML5992	8056826	ML6313	8072903	ML6127
8004223	ML5269	8008418	ML5936	8037207	ML6255	8056827	ML6312	8072904	ML6215
8004224	ML5928	8008419	ML5938	8041402	ML5995	8056828	ML6310	8075700	ML5359

MONROE® MAX-LIFT® CROSS REFERENCE LIST

LESJOFORS

LESJOFORS	MONROE®	LESJOFORS	MONROE®	LESJOFORS	MONROE®	LESJOFORS	MONROE®	LESJOFORS	MONROE®
8075702	ML6004	8104209	ML5428	8114210	ML6228	8117704	ML5714	8127521	ML5143
8075703	ML6033	8104210	ML5111	8114211	ML5943	8117704	ML5941	8127522	ML5147
8075704	ML6006	8104210	ML6269	8114900	ML6113	8117705	ML5941	8127524	ML5126
8077601	ML5556	8104211	ML5418	8114902	ML5946	8117706	ML5746	8127525	ML5176
8077800	ML5636	8104214	ML5135	8114903	ML5944	8117708	ML5747	8127527	ML5332
8077801	ML5731	8104215	ML5197	8115600	ML5607	8119112	ML6084	8127529	ML5611
8077802	ML5349	8104219	ML5238	8115601	ML5601	8126101	ML5015	8127531	ML5110
8077803	ML5350	8104221	ML5277	8115602	ML5603	8126101	ML5041	8127532	ML5612
8077804	ML5638	8104222	ML6150	8115603	ML5604	8126102	ML5011	8127533	ML5388
8077805	ML5790	8104223	ML5449	8115604	ML5605	8126104	ML5043	8127534	ML5080
8077806	ML5558	8104224	ML5275	8115605	ML5452	8126105	ML5074	8127535	ML5253
8082900	ML5195	8104225	ML5370	8115606	ML5606	8126106	ML5016	8127536	ML5614
8082901	ML5342	8104226	ML5223	8115607	ML5609	8126106	ML5039	8127537	ML5293
8082903	ML5386	8104226	ML5234	8115608	ML5010	8126107	ML5079	8127538	ML5294
8082904	ML6217	8104227	ML5227	8115609	ML5011	8126108	ML5041	8127539	ML5136
8085700	ML5768	8104229	ML5749	8115611	ML5019	8126109	ML5010	8127540	ML5980
8085701	ML6079	8104230	ML5744	8115612	ML5504	8126111	ML5013	8127541	ML5147
8092500	ML6323	8104231	ML5746	8115613	ML5505	8126112	ML5014	8127542	ML5290
8092501	ML6368	8104232	ML5745	8115614	ML5255	8126113	ML5012	8127543	ML5431
8092502	ML6324	8104233	ML5747	8115615	ML5033	8126113	ML5065	8127544	ML5429
8092503	ML6325	8104234	ML5223	8115616	ML5506	8126114	ML5040	8127545	ML5076
8092505	ML6345	8104237	ML5753	8115617	ML5011	8126114	ML5112	8127546	ML5399
8094602	ML5732	8104238	ML5930	8115618	ML5203	8126118	ML5042	8127547	ML5224
8095000	ML5266	8104240	ML5922	8115619	ML5430	8126119	ML5081	8127548	ML5168
8095000	ML5733	8104241	ML5923	8115620	ML5129	8126120	ML5282	8127549	ML5127
8095001	ML5393	8104242	ML5918	8115622	ML5113	8126121	ML5283	8127550	ML5502
8095002	ML5195	8104243	ML6102	8115623	ML5454	8126122	ML5068	8127551	ML5231
8095003	ML5287	8104244	ML6103	8115623	ML5626	8126123	ML5069	8127552	ML5374
8095004	ML5266	8104248	ML5929	8115624	ML5456	8126125	ML5078	8127553	ML5514
8095005	ML5735	8104249	ML6227	8115624	ML5627	8126126	ML5164	8127554	ML5466
8095006	ML5832	8104255	ML6226	8115625	ML5363	8126127	ML5081	8127554	ML5467
8095007	ML5736	8104256	ML6192	8115625	ML5455	8126128	ML5458	8127555	ML5289
8095010	ML5261	8104257	ML6105	8115626	ML5149	8126129	ML5377	8127556	ML5206
8095010	ML5264	8104261	ML6347	8115627	ML5203	8126130	ML5086	8127556	ML5207
8095011	ML5829	8104262	ML6346	8115628	ML5204	8126131	ML5281	8127557	ML5757
8095012	ML5357	8104263	ML6291	8115628	ML5744	8126132	ML5280	8127558	ML5288
8095014	ML5733	8104264	ML6290	8115629	ML5435	8126134	ML5462	8127559	ML5416
8095014	ML5734	8105800	ML5017	8115630	ML5151	8126135	ML5016	8127560	ML5664
8095017	ML6096	8108401	ML5450	8115631	ML5536	8126137	ML5443	8127561	ML5786
8095018	ML6097	8108402	ML5170	8115632	ML5391	8126138	ML5448	8127562	ML5205
8095019	ML5191	8108403	ML5444	8115633	ML5453	8126139	ML5749	8127563	ML5771
8095019	ML5265	8108404	ML5445	8115634	ML5344	8126140	ML5702	8127564	ML5770
8095025	ML6152	8108405	ML5521	8115636	ML5506	8126141	ML5795	8127565	ML5978
8095027	ML6365	8108406	ML5521	8115637	ML5668	8126145	ML5775	8127566	ML5797
8095801	ML5368	8108407	ML5934	8115638	ML5824	8126147	ML5950	8127567	ML5797
8095802	ML5643	8108409	ML5436	8115639	ML5782	8126148	ML5784	8127568	ML5704
8095803	ML5359	8108410	ML5235	8115640	ML5963	8126149	ML5968	8127569	ML5772
8095805	ML5726	8108410	ML5451	8115641	ML5967	8126154	ML6201	8127570	ML5295
8095807	ML6136	8108411	ML5163	8115642	ML5783	8126157	ML5974	8127574	ML5979
8095808	ML6222	8108412	ML5213	8115643	ML5958	8126158	ML6277	8127575	ML5977
8095809	ML6254	8108414	ML5523	8115644	ML5959	8126160	ML6344	8127578	ML6202
8100702	ML5273	8108416	ML5520	8115645	ML5755	8126161	ML6230	8127583	ML6299
8100705	ML5335	8108416	ML5590	8115646	ML5961	8127500	ML5463	8127584	ML6287
8100706	ML5335	8108417	ML5535	8115647	ML5950	8127501	ML5464	8127585	ML6297
8100707	ML5531	8108418	ML5690	8115648	ML5776	8127501	ML5753	8127586	ML6298
8100708	ML5532	8108420	ML5170	8115649	ML5776	8127503	ML5200	8127587	ML6354
8100709	ML5271	8108421	ML5691	8115650	ML6143	8127503	ML5201	8127593	ML6356
8100710	ML5272	8108422	ML6141	8115652	ML5687	8127504	ML5285	8135712	ML5405
8100711	ML5215	8108423	ML5694	8115653	ML5756	8127505	ML5286	8135717	ML5787
8100712	ML5442	8108428	ML5692	8115654	ML6114	8127505	ML5755	8135718	ML5122
8100713	ML5419	8108429	ML5695	8115655	ML5862	8127506	ML5285	8135721	ML5567
8100714	ML5222	8108430	ML5693	8115656	ML5968	8127506	ML5286	8135722	ML5371
8100716	ML6149	8108434	ML6194	8115658	ML5948	8127507	ML5756	8135723	ML5396
8100717	ML6137	8108436	ML6350	8115659	ML5956	8127508	ML5171	8135725	ML5192
8100719	ML5698	8108437	ML6348	8115660	ML5954	8127509	ML5172	8135725	ML5508
8100721	ML5921	8108438	ML6351	8115660	ML5956	8127510	ML5173	8135729	ML5836
8100722	ML5920	8108442	ML6110	8115661	ML6196	8127511	ML5161	8135731	ML5982
8100724	ML5442	8114200	ML5794	8115662	ML6197	8127512	ML5252	8135734	ML5983
8100725	ML6190	8114201	ML5941	8115664	ML6115	8127513	ML5109	8135735	ML5984
8104203	ML5417	8114202	ML6140	8115670	ML6352	8127514	ML5147	8137200	ML5157
8104204	ML5533	8114204	ML5714	8117700	ML5087	8127517	ML5465	8137205	ML5987
8104205	ML5376	8114205	ML5940	8117701	ML5098	8127518	ML5023	8137206	ML5987
8104206	ML5104	8114208	ML6295	8117702	ML5096	8127519	ML5141	8137207	ML5296
8104207	ML5437	8114209	ML6296	8117703	ML5745	8127520	ML5142	8137208	ML5816

MONROE® MAX-LIFT® CROSS REFERENCE LIST

LESJOFORS

LESJOFORS	MONROE®	LESJOFORS	MONROE®	LESJOFORS	MONROE®	LESJOFORS	MONROE®	LESJOFORS	MONROE®
8137211	ML5986	8156800	ML5186	8162052	ML6285	8163483	ML6361	8172910	ML5545
8137214	ML5986	8156800	ML5187	8162055	ML6131	8166700	ML5364	8172911	ML5310
8137217	ML5759	8156801	ML5307	8162056	ML6131	8166701	ML5133	8172912	ML5256
8137218	ML5616	8156802	ML5674	8162060	ML6316	8166702	ML5020	8172913	ML5631
8137220	ML5297	8156803	ML5328	8162061	ML6318	8166704	ML5628	8172913	ML5776
8137221	ML5993	8156805	ML6173	8162065	ML6364	8166705	ML5364	8172914	ML5383
8137221	ML6169	8156806	ML5560	8162066	ML6363	8166706	ML5148	8172915	ML5131
8137222	ML5760	8156806	ML5763	8163400	ML5390	8166709	ML5202	8172916	ML5526
8137223	ML5762	8156807	ML5530	8163401	ML5395	8166710	ML5326	8172917	ML5241
8137230	ML5757	8156807	ML5577	8163402	ML5391	8166711	ML5426	8172918	ML5313
8137231	ML5379	8156808	ML5716	8163403	ML5077	8166712	ML5067	8172919	ML5314
8137232	ML5569	8156810	ML5717	8163404	ML5156	8166714	ML5625	8172920	ML5228
8137233	ML5380	8156811	ML5718	8163405	ML5125	8166715	ML5311	8172920	ML5229
8137237	ML5990	8156812	ML5718	8163406	ML5367	8166717	ML5180	8172921	ML5158
8137243	ML6203	8156813	ML5808	8163407	ML5585	8166719	ML5319	8172922	ML5130
8137244	ML6232	8156814	ML5808	8163408	ML5527	8166720	ML5146	8172923	ML5094
8137247	ML5991	8156815	ML5806	8163409	ML5242	8166720	ML5316	8172924	ML5553
8141405	ML5996	8156816	ML5806	8163410	ML5054	8166721	ML5134	8172925	ML5128
8141407	ML6204	8156818	ML6028	8163411	ML5144	8166723	ML5432	8172926	ML5189
8142102	ML6001	8156820	ML5818	8163417	ML5243	8166724	ML5767	8172927	ML5440
8142103	ML5997	8156822	ML6017	8163418	ML5031	8166725	ML5768	8172927	ML5474
8142104	ML5998	8156823	ML6016	8163419	ML5244	8166727	ML5113	8172928	ML5190
8142109	ML6117	8156825	ML6016	8163420	ML5835	8166728	ML5323	8172929	ML5212
8142110	ML6116	8156826	ML5800	8163421	ML5528	8166729	ML5469	8172933	ML5826
8142115	ML6300	8156829	ML6030	8163421	ML5834	8166730	ML5160	8172934	ML5475
8142116	ML6301	8156831	ML6210	8163422	ML5407	8166731	ML5425	8172935	ML5552
8142117	ML6302	8156833	ML6022	8163423	ML5407	8166732	ML5358	8172936	ML5725
8144209	ML5711	8156836	ML5813	8163424	ML5408	8166733	ML5773	8172937	ML5526
8144210	ML5709	8158506	ML5764	8163425	ML5408	8166734	ML5950	8172939	ML5372
8144211	ML5708	8158506	ML5766	8163426	ML5210	8166735	ML5776	8172940	ML5828
8144212	ML5708	8158508	ML5412	8163427	ML5103	8166736	ML5776	8172941	ML5812
8144213	ML5712	8158509	ML5623	8163428	ML5398	8166737	ML5687	8172942	ML5789
8144214	ML6303	8158701	ML6036	8163429	ML5032	8166739	ML5730	8172943	ML5724
8144216	ML5707	8158704	ML6035	8163430	ML5258	8166740	ML5728	8172944	ML6075
8144217	ML5823	8158705	ML5175	8163432	ML5082	8166741	ML5727	8172951	ML6070
8144222	ML6002	8158706	ML6314	8163435	ML5166	8166742	ML5729	8172955	ML6063
8144223	ML6002	8159200	ML5578	8163436	ML5138	8166743	ML6280	8172957	ML6071
8144235	ML6236	8159201	ML5354	8163437	ML5424	8166744	ML5731	8172958	ML6072
8144236	ML6236	8159202	ML5278	8163438	ML5515	8166747	ML5732	8172959	ML6073
8144240	ML6206	8159203	ML5587	8163439	ML5515	8166748	ML5734	8172960	ML6128
8144243	ML6235	8159215	ML5353	8163440	ML5369	8166750	ML5344	8172961	ML6125
8147000	ML5024	8159217	ML6038	8163442	ML5137	8166751	ML5340	8172964	ML5776
8147002	ML6273	8159220	ML5757	8163443	ML5120	8166753	ML5774	8172965	ML6214
8147002	ML6278	8159221	ML5757	8163444	ML5088	8166754	ML6058	8172967	ML6242
8147003	ML6279	8159222	ML5776	8163445	ML5089	8166755	ML6060	8172968	ML6244
8147004	ML6272	8159223	ML5776	8163446	ML6047	8166756	ML5968	8172972	ML6339
8148400	ML5617	8159233	ML6315	8163448	ML5366	8166757	ML5948	8175701	ML5041
8148401	ML5139	8162004	ML5524	8163449	ML5365	8166758	ML5948	8175702	ML5192
8148401	ML5598	8162005	ML5525	8163450	ML5341	8166759	ML5954	8175703	ML5634
8148403	ML5702	8162006	ML5317	8163451	ML5773	8166759	ML5956	8175704	ML5777
8148407	ML6003	8162007	ML5588	8163452	ML5516	8166760	ML5954	8175704	ML5338
8155422	ML5684	8162008	ML5423	8163452	ML5516	8166760	ML5956	8175705	ML5384
8155423	ML5683	8162008	ML5423	8163453	ML5721	8166761	ML6123	8175706	ML5384
8155424	ML6338	8162012	ML5409	8163454	ML5669	8166762	ML6124	8175707	ML5208
8155425	ML6337	8162015	ML6041	8163455	ML5817	8166766	ML6213	8175707	ML5209
8155436	ML5765	8162016	ML5580	8163456	ML6005	8166767	ML5705	8175708	ML5362
8155437	ML5763	8162017	ML5581	8163457	ML6044	8166768	ML6360	8175710	ML5306
8155437	ML5764	8162018	ML6040	8163458	ML6044	8166771	ML6353	8175711	ML5306
8155441	ML5764	8162019	ML6040	8163459	ML6146	8168700	ML5595	8175712	ML5434
8155442	ML6014	8162025	ML5579	8163460	ML5827	8169700	ML5595	8175713	ML6148
8155443	ML6014	8162026	ML5579	8163461	ML5807	8169701	ML5594	8175715	ML5478
8155444	ML6012	8162028	ML5781	8163462	ML6043	8169705	ML6066	8175715	ML5777
8155445	ML6012	8162029	ML5700	8163463	ML5345	8169706	ML6067	8175716	ML5649
8155448	ML6011	8162030	ML5321	8163464	ML5722	8169708	ML6065	8175720	ML5412
8155450	ML6013	8162031	ML5582	8163464	ML5722	8169709	ML5804	8175721	ML6005
8155451	ML6013	8162039	ML5352	8163467	ML5940	8172900	ML5021	8175722	ML6209
8155452	ML5810	8162040	ML5672	8163470	ML5723	8172901	ML5630	8175724	ML6234
8155454	ML6015	8162041	ML5701	8163471	ML6051	8172904	ML5310	8175726	ML5623
8155456	ML6120	8162042	ML5809	8163472	ML6055	8172905	ML5004	8175727	ML6207
8155457	ML6120	8162043	ML5809	8163473	ML6122	8172906	ML5093	8175729	ML6305
8155458	ML6120	8162044	ML5809	8163475	ML6057	8172907	ML5320	8177800	ML5613
8155462	ML6306	8162045	ML5809	8163477	ML6240	8172908	ML5331	8177801	ML5635
8155463	ML6307	8162046	ML5128	8163479	ML6239	8172909	ML5254	8177802	ML5400
8155464	ML6308	8162049	ML6042	8163481	ML6286				
		8162050	ML6042	8163482	ML6362				

MONROE® MAX-LIFT® CROSS REFERENCE LIST

LESJOFORS

LESJOFORS	MONROE®	LESJOFORS	MONROE®	LESJOFORS	MONROE®	LESJOFORS	MONROE®	LESJOFORS	MONROE®
8177803	ML5401	8185714	ML6218	8192566	ML5666	8195005	ML5049	8195059	ML5830
8177804	ML5498	8185715	ML6130	8192570	ML6132	8195006	ML5191	8195060	ML5135
8177805	ML5499	8185716	ML6081	8192571	ML6133	8195011	ML5123	8195063	ML5742
8177806	ML5494	8185721	ML6289	8192572	ML6133	8195012	ML5123	8195065	ML6099
8177807	ML5496	8185722	ML6322	8192574	ML5777	8195014	ML5644	8195066	ML6098
8177808	ML5495	8185723	ML6322	8192577	ML6135	8195015	ML5644	8195067	ML6100
8177809	ML5557	8186000	ML5640	8192578	ML6134	8195016	ML5177	8195079	ML6247
8177810	ML5497	8186001	ML6082	8192588	ML6359	8195017	ML5178	8195087	ML6326
8177811	ML5402	8186003	ML6083	8194603	ML5783	8195020	ML5677	8195088	ML6327
8177812	ML5375	8188304	ML5820	8194604	ML5788	8195021	ML5677	8195090	ML6357
8177813	ML5558	8188305	ML5819	8194605	ML5789	8195022	ML5106	8195807	ML5642
8177814	ML5637	8188308	ML6084	8194606	ML5790	8195023	ML5246	8195808	ML5571
8177820	ML6076	8188900	ML5589	8194607	ML5794	8195024	ML5245	8195809	ML5571
8177821	ML6076	8188901	ML5589	8194608	ML5794	8195025	ML5118	8195810	ML5509
8182900	ML5063	8188906	ML5092	8194609	ML5798	8195026	ML5249	8195813	ML5312
8182901	ML5140	8188907	ML5091	8194610	ML5799	8195027	ML5226	8195815	ML5840
8182902	ML5124	8188910	ML5780	8194611	ML5395	8195029	ML5106	8195816	ML5529
8182903	ML5022	8188911	ML5780	8194612	ML5800	8195030	ML5127	8195817	ML5347
8182904	ML5127	8188914	ML6086	8194613	ML5801	8195031	ML5145	8195818	ML5347
8182905	ML5284	8188915	ML6086	8194614	ML5802	8195032	ML5675	8195818	ML5348
8182905	ML5777	8188918	ML5078	8194615	ML5803	8195033	ML5132	8195819	ML5154
8182906	ML5100	8188919	ML5078	8194619	ML5805	8195033	ML5185	8195820	ML5154
8182907	ML5259	8188923	ML6219	8194620	ML5806	8195035	ML5135	8195821	ML5184
8182908	ML5181	8192528	ML6089	8194621	ML5806	8195035	ML5840	8195822	ML5909
8182909	ML5639	8192529	ML6089	8194622	ML5807	8195036	ML5193	8195823	ML5909
8182910	ML5016	8192532	ML5592	8194623	ML5808	8195037	ML5325	8195824	ML5489
8182911	ML5193	8192533	ML5592	8194624	ML5808	8195038	ML5135	8195825	ML5685
8182912	ML5778	8192534	ML5121	8194628	ML5809	8195038	ML5193	8195826	ML5481
8182913	ML5225	8192541	ML5486	8194629	ML5811	8195039	ML5132	8195828	ML5488
8182916	ML5767	8192546	ML5485	8194630	ML5812	8195040	ML5261	8195831	ML6091
8182919	ML6129	8192547	ML5963	8194631	ML5817	8195040	ML5846	8195832	ML6092
8182921	ML6078	8192547	ML6087	8194632	ML5818	8195041	ML5199	8195832	ML6094
8182922	ML6216	8192548	ML5963	8194633	ML5819	8195042	ML5063	8195834	ML6224
8182924	ML6245	8192548	ML6087	8194635	ML5820	8195043	ML5100	8195835	ML6246
8182927	ML6321	8192549	ML5963	8194636	ML5824	8195044	ML5132	8195836	ML5488
8185700	ML5044	8192550	ML5641	8194637	ML5826	8195045	ML5742	8195837	ML6223
8185700	ML5048	8192555	ML5778	8194638	ML5827	8195046	ML5575	8195841	ML6094
8185701	ML5057	8192555	ML5821	8194639	ML5828	8195047	ML5743	8772956	ML6126
8185702	ML5061	8192556	ML5781	8194640	ML5834	8195048	ML5194		
8185703	ML5217	8192556	ML5821	8194642	ML5834	8195050	ML5750		
8185704	ML5045	8192557	ML5647	8194643	ML5834	8195051	ML5796		
8185705	ML5175	8192558	ML5699	8195000	ML5572	8195053	ML5792		
8185706	ML5777	8192559	ML5963	8195001	ML5573	8195054	ML5754		
8185707	ML5665	8192560	ML5963	8195002	ML5073	8195055	ML5751		
8185708	ML6332	8192561	ML5687	8195003	ML5574	8195056	ML5831		
8185713	ML6080	8192561	ML6151	8195004	ML5038	8195057	ML5793		

QH (LIP)

QH (LIP)	MONROE®	QH (LIP)	MONROE®	QH (LIP)	MONROE®	QH (LIP)	MONROE®	QH (LIP)	MONROE®
12886	ML5500	128083	ML5492	128135	ML5033	128180	ML5282	128287	ML5041
128002	ML5011	128086	ML5603	128140	ML5040	128182	ML5041	128288	ML5208
128003	ML5606	128087	ML5611	128140	ML5112	128182	ML5720	128289	ML5286
128007	ML5015	128088	ML5639	128141	ML5014	128183	ML5064	128290	ML5200
128022	ML5019	128089	ML5463	128146	ML5255	128185	ML5148	128291	ML5201
128024	ML5010	128090	ML5464	128147	ML5094	128190	ML5266	128293	ML5306
128029	ML5042	128092	ML5038	128148	ML5124	128191	ML5135	128294	ML5243
128052	ML5465	128096	ML5632	128149	ML5140	128223	ML5020	128295	ML5528
128053	ML5023	128097	ML5630	128150	ML5063	128244	ML5311	128295	ML5834
128056	ML5601	128098	ML5602	128152	ML5553	128245	ML5426	128296	ML5407
128058	ML5625	128099	ML5605	128153	ML5331	128249	ML5177	128297	ML5125
128062	ML5010	128106	ML5147	128155	ML5106	128252	ML5642	128297	ML5156
128065	ML5019	128108	ML5607	128156	ML5065	128254	ML5312	128298	ML5390
128066	ML5022	128113	ML5016	128157	ML5032	128255	ML5400	128299	ML5527
128069	ML5009	128114	ML5017	128158	ML5171	128256	ML5401	128300	ML5073
128069	ML5011	128118	ML5202	128159	ML5172	128257	ML5452	128301	ML5123
128070	ML5021	128119	ML5631	128160	ML5161	128261	ML5617	128302	ML5178
128071	ML5625	128123	ML5004	128161	ML5077	128262	ML5618	128304	ML5313
128073	ML5252	128124	ML5574	128162	ML5133	128264	ML5039	128305	ML5314
128074	ML5501	128125	ML6085	128169	ML5582	128272	ML5080	128319	ML5429
128075	ML5644	128131	ML5310	128170	ML5582	128273	ML5253	128320	ML5076
128076	ML5585	128132	ML5093	128178	ML5079	128282	ML5539	128321	ML5180
128078	ML5600	128133	ML5141	128178	ML5814	128283	ML5293	128323	ML5149
		128134	ML5142	128179	ML5043	128284	ML5294	128324	ML5283

MONROE® MAX-LIFT® CROSS REFERENCE LIST

QH (LIP)

QH (LIP)	MONROE®	QH (LIP)	MONROE®	QH (LIP)	MONROE®	QH (LIP)	MONROE®	QH (LIP)	MONROE®
128325	ML5305	128417	ML5532	128539	ML5481	128638	ML5633	128728	ML5348
128327	ML5126	128418	ML5274	128542	ML5542	128639	ML5549	128729	ML5487
128328	ML5679	128419	ML5273	128543	ML5403	128640	ML5327	128731	ML5187
128331	ML5835	128420	ML5434	128551	ML5301	128642	ML5555	128732	ML6173
128335	ML5430	128421	ML5192	128561	ML5302	128643	ML5337	128733	ML5349
128336	ML5143	128422	ML5508	128562	ML5220	128644	ML5338	128734	ML5636
128337	ML5370	128422	ML5634	128563	ML5218	128645	ML5635	128735	ML5351
128338	ML5203	128423	ML5129	128564	ML5219	128653	ML6033	128736	ML5483
128339	ML5204	128424	ML5435	128565	ML5175	128654	ML5399	128737	ML5484
128340	ML5069	128426	ML5386	128566	ML5165	128655	ML5330	128738	ML5482
128341	ML5068	128428	ML5628	128567	ML5160	128658	ML5336	128740	ML5096
128342	ML5544	128429	ML5024	128568	ML5439	128659	ML5260	128741	ML5447
128343	ML5545	128430	ML5228	128569	ML5222	128661	ML5909	128744	ML5297
128344	ML5279	128431	ML5614	128570	ML5410	128662	ML5535	128745	ML5381
128345	ML5383	128432	ML5214	128571	ML5478	128663	ML5441	128746	ML5382
128347	ML5266	128433	ML5109	128571	ML5622	128664	ML5263	128747	ML5570
128348	ML5317	128434	ML5320	128573	ML5462	128665	ML5213	128748	ML5378
128349	ML5318	128435	ML5376	128575	ML5216	128666	ML5565	128749	ML5379
128350	ML5524	128436	ML5104	128576	ML5215	128667	ML5280	128750	ML5380
128351	ML5525	128438	ML5533	128577	ML5392	128668	ML5281	128751	ML5616
128352	ML5131	128439	ML5185	128579	ML5391	128669	ML5458	128752	ML5352
128353	ML5145	128440	ML5170	128580	ML5619	128670	ML5419	128753	ML5086
128354	ML5506	128441	ML5384	128581	ML5391	128670	ML6047	128754	ML5413
128356	ML5049	128442	ML5417	128582	ML5270	128671	ML5414	128755	ML5423
128357	ML5031	128444	ML5323	128583	ML5292	128672	ML5467	128756	ML5581
128358	ML5244	128445	ML5132	128584	ML5374	128673	ML5206	128757	ML5353
128362	ML5408	128446	ML5291	128585	ML5231	128674	ML5169	128758	ML5354
128363	ML5258	128447	ML5612	128586	ML5502	128675	ML5289	128759	ML5355
128363	ML5721	128448	ML5110	128588	ML5134	128675	ML5782	128759	ML5729
128365	ML5111	128449	ML5128	128589	ML5579	128676	ML5151	128760	ML5334
128365	ML6269	128450	ML5539	128591	ML5087	128677	ML5211	128761	ML5356
128366	ML5428	128451	ML5493	128592	ML5507	128678	ML5259	128762	ML5357
128367	ML5144	128457	ML5246	128593	ML5446	128679	ML5341	128763	ML5583
128368	ML5242	128458	ML5245	128593	ML5513	128680	ML5773	128764	ML5268
128369	ML5054	128459	ML5247	128594	ML5098	128681	ML5196	128765	ML5267
128371	ML5315	128460	ML5105	128595	ML5157	128682	ML5225	128766	ML6076
128372	ML5290	128498	ML5489	128596	ML5569	128683	ML5198	128767	ML5558
128373	ML5431	128499	ML5450	128597	ML5296	128684	ML5068	128768	ML5375
128374	ML5176	128500	ML5166	128598	ML5515	128685	ML5207	128769	ML5397
128375	ML5332	128501	ML5307	128599	ML5494	128686	ML5389	128770	ML5442
128376	ML5081	128502	ML5138	128600	ML5257	128687	ML5209	128771	ML5404
128377	ML5103	128503	ML5217	128601	ML5085	128689	ML5183	128772	ML5702
128379	ML5554	128504	ML5436	128602	ML5167	128693	ML5221	128773	ML5101
128380	ML5303	128505	ML5195	128603	ML5190	128694	ML5340	128774	ML5443
128381	ML5505	128506	ML5086	128604	ML5476	128695	ML5205	128775	ML5538
128382	ML5226	128507	ML5188	128605	ML5477	128696	ML5586	128776	ML5122
128383	ML5197	128510	ML5146	128606	ML5229	128697	ML5608	128777	ML5396
128384	ML5210	128511	ML5241	128607	ML5474	128698	ML5919	128778	ML5371
128385	ML5316	128512	ML5193	128608	ML5158	128699	ML5227	128779	ML5406
128387	ML5078	128513	ML5224	128609	ML5383	128699	ML5592	128782	ML5360
128388	ML5136	128514	ML5168	128610	ML5155	128701	ML5269	128783	ML5119
128389	ML5139	128515	ML5466	128611	ML5182	128702	ML5342	128783	ML6005
128389	ML5598	128516	ML5137	128612	ML5440	128703	ML5265	128784	ML5412
128390	ML5159	128517	ML5418	128613	ML5383	128704	ML5061	128785	ML5479
128391	ML5150	128518	ML5162	128614	ML5152	128705	ML5491	128785	ML5623
128391	ML5262	128519	ML5164	128615	ML5130	128706	ML5469	128786	ML5394
128392	ML5082	128520	ML5186	128616	ML5153	128707	ML5343	128786	ML5815
128393	ML5424	128521	ML5234	128617	ML5189	128708	ML5344	128787	ML5121
128394	ML5284	128522	ML5238	128618	ML5277	128709	ML5212	128788	ML5485
128395	ML5100	128523	ML5239	128619	ML5593	128710	ML5345	128789	ML5486
128396	ML5154	128524	ML5377	128620	ML5480	128711	ML5461	128790	ML5641
128397	ML5184	128525	ML5120	128621	ML5261	128712	ML5276	128791	ML5346
128398	ML5321	128526	ML5437	128622	ML5333	128714	ML5275	128792	ML5358
128399	ML5322	128527	ML5534	128623	ML5677	128715	ML5536	128793	ML5537
128401	ML5432	128528	ML5223	128624	ML5573	128718	ML6150	128805	ML5453
128402	ML5319	128529	ML5045	128625	ML5191	128719	ML5449	128806	ML5460
128405	ML5324	128530	ML5254	128626	ML5420	128720	ML5239	128808	ML5459
128406	ML5433	128531	ML5181	128628	ML5240	128721	ML6150	128809	ML5233
128407	ML5580	128532	ML5388	128630	ML5571	128722	ML5199	128810	ML5512
128412	ML5540	128533	ML5572	128632	ML5326	128723	ML5287	128811	ML5742
128413	ML5335	128534	ML5325	128633	ML5457	128724	ML5264	128812	ML5194
128414	ML5272	128536	ML5411	128635	ML5364	128725	ML5339	128813	ML5232
128415	ML5271	128537	ML5438	128636	ML5067	128726	ML5393	128814	ML5288
128416	ML5531	128538	ML5113	128637	ML5256	128727	ML5347	128815	ML5295

MONROE® MAX-LIFT® CROSS REFERENCE LIST

QH (LIP)

QH (LIP)	MONROE®	QH (LIP)	MONROE®	QH (LIP)	MONROE®	QH (LIP)	MONROE®	QH (LIP)	MONROE®
128825	ML5980	140074	ML5609	140325	ML5575	828146	ML5936	828352	ML6245
128826	ML5543	140075	ML5503	140326	ML5576	828149	ML5938	828354	ML6217
128831	ML5308	140080	ML5546	140327	ML5584	828150	ML5098	828357	ML5929
128833	ML5309	140084	ML5629	140329	ML5816	828160	ML5950	840021	ML5556
128843	ML5588	140114	ML5517	140334	ML5615	828166	ML5416	840024	ML5422
128850	ML5359	140115	ML5471	828001	ML6149	828168	ML5664	840025	ML5596
128851	ML5496	140116	ML5448	828004	ML6191	828170	ML5371	840075	ML5503
128852	ML5495	140121	ML5365	828005	ML6190	828172	ML5382	840080	ML5546
128853	ML5557	140122	ML5366	828007	ML6138	828173	ML5993	840084	ML5629
128854	ML5497	140123	ML5230	828008	ML5749	828180	ML5999	840114	ML5517
128855	ML5498	140124	ML5526	828009	ML6102	828181	ML5997	840115	ML5471
128856	ML5499	140125	ML5686	828010	ML5737	828182	ML5998	840116	ML5448
128859	ML5044	140126	ML5548	828011	ML5740	828183	ML5706	840121	ML5365
128859	ML5048	140127	ML5250	828012	ML5753	828184	ML5709	840124	ML5526
128860	ML5589	140128	ML5675	828014	ML5928	828189	ML5707	840125	ML5686
128862	ML5509	140130	ML5511	828015	ML5739	828194	ML5718	840127	ML5249
128865	ML5645	140131	ML5510	828016	ML5563	828202	ML6312	840128	ML5675
128880	ML5490	140135	ML5118	828017	ML5689	828211	ML5757	840130	ML5511
128881	ML5427	140136	ML5249	828019	ML5695	828219	ML5805	840131	ML5510
128882	ML5361	140137	ML5251	828022	ML5687	828220	ML5807	840132	ML5927
128883	ML5368	140138	ML5248	828023	ML5782	828221	ML6051	840134	ML5973
128884	ML5373	140144	ML5367	828026	ML6143	828223	ML5733	840135	ML5118
128885	ML5470	140145	ML5547	828027	ML5968	828227	ML5475	840136	ML5249
128886	ML5500	140154	ML5237	828032	ML5448	828227	ML5826	840137	ML5251
128887	ML5488	140155	ML5235	828033	ML5074	828230	ML5724	840138	ML5248
128888	ML5387	140156	ML5163	828035	ML5975	828230	ML6075	840144	ML5367
128889	ML5541	140157	ML5444	828036	ML5779	828233	ML5766	840145	ML5547
128890	ML5727	140158	ML5521	828037	ML5416	828234	ML5665	840154	ML5235
128890	ML5743	140165	ML5102	828037	ML5786	828241	ML5699	840154	ML5236
128891	ML5728	140169	ML5674	828040	ML5704	828243	ML5963	840155	ML5235
128892	ML5372	140170	ML5089	828042	ML5704	828252	ML6196	840156	ML5163
128893	ML5812	140171	ML5088	828044	ML5295	828257	ML5862	840165	ML5102
128895	ML5789	140175	ML5685	828045	ML5514	828262	ML6060	840169	ML5674
128896	ML5826	140176	ML5529	828046	ML5514	828263	ML6058	840170	ML5088
128897	ML5475	140177	ML5127	828047	ML5836	828264	ML6280	840171	ML5088
128899	ML5672	140180	ML5421	828050	ML5823	828266	ML6213	840175	ML5685
128900	ML5472	140181	ML5522	828051	ML5705	828269	ML6123	840176	ML5529
128901	ML5473	140182	ML5934	828055	ML6003	828271	ML6253	840177	ML5127
128902	ML5744	140183	ML5566	828056	ML5703	828272	ML5954	840180	ML5421
128903	ML5736	140184	ML5445	828058	ML5763	828273	ML5956	840182	ML5934
128904	ML5832	140185	ML5520	828059	ML6120	828275	ML5948	840184	ML5445
128905	ML5735	140186	ML5590	828062	ML6021	828276	ML6131	840185	ML5520
128910	ML5669	140187	ML5523	828064	ML5717	828283	ML6063	840188	ML5974
128911	ML5817	140190	ML5451	828066	ML6027	828289	ML6128	840190	ML5451
128913	ML5559	140191	ML5236	828070	ML6032	828290	ML6125	840193	ML5179
128914	ML5530	140192	ML5399	828071	ML6036	828298	ML6115	840194	ML5425
128915	ML5987	140193	ML5179	828077	ML5701	828300	ML5961	840232	ML6338
128916	ML5562	140194	ML5425	828078	ML6042	828301	ML5959	840233	ML6337
128917	ML5711	140197	ML5599	828079	ML6044	828302	ML5958	840238	ML5640
128918	ML5683	140224	ML5842	828080	ML6122	828308	ML6096	840240	ML5328
128919	ML5684	140225	ML5843	828081	ML5827	828309	ML6214	840240	ML5621
128920	ML5759	140228	ML5848	828082	ML6049	828310	ML6215	840251	ML6038
128921	ML6014	140229	ML5847	828084	ML5345	828311	ML6074	840259	ML5369
128922	ML5765	140238	ML5640	828085	ML5722	828312	ML6071	840260	ML5550
128924	ML5769	140239	ML5329	828092	ML6072	828316	ML6284	840261	ML6251
128925	ML5688	140240	ML5328	828093	ML6127	828317	ML5793	840262	ML5637
128927	ML5691	140259	ML5369	828094	ML6073	828321	ML6277	840269	ML6089
128928	ML5690	140260	ML5550	828098	ML5665	828325	ML5784	840270	ML6089
128929	ML5693	140261	ML5646	828100	ML6080	828326	ML6202	840298	ML5840
128930	ML5778	140262	ML5637	828101	ML6130	828330	ML6192	840299	ML5643
128931	ML5764	140298	ML5840	828103	ML5589	828330	ML6226	840301	ML5568
128935	ML5696	140299	ML5643	828104	ML5780	828331	ML6192	840303	ML5578
128937	ML5986	140300	ML5567	828111	ML5963	828331	ML6226	840305	ML5624
128938	ML5726	140301	ML5568	828113	ML5777	828334	ML6078	840307	ML5846
128939	ML5821	140303	ML5578	828116	ML6222	828335	ML6081	840310	ML5613
128940	ML5699	140304	ML5587	828117	ML6091	828338	ML6218	840312	ML5560
128941	ML5647	140305	ML5624	828118	ML6136	828339	ML6216	840313	ML5577
128958	ML6040	140310	ML5613	828126	ML6100	828340	ML6352	840323	ML5552
128959	ML5672	140312	ML5560	828131	ML5921	828341	ML6353	840336	ML5558
128960	ML5809	140313	ML5577	828133	ML5386	828342	ML5415	840337	ML5787
140021	ML5556	140320	ML5518	828135	ML5746	828344	ML6197		
140024	ML5422	140321	ML5519	828137	ML5925	828346	ML6198		
140025	ML5596	140322	ML5551	828138	ML5924	828349	ML6199		
140046	ML5504	140324	ML5514	828139	ML5926	828351	ML6200		

DIMENSION CHART

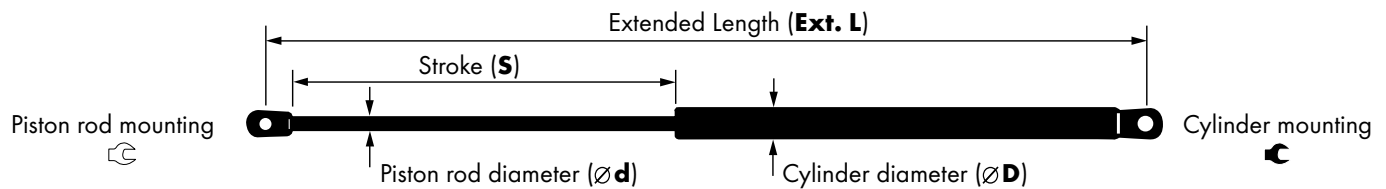

Monroe®	C	↺	↻	Ød	ØD	Ext. L	S	F1
ML5003	U		U	8	18,5	450	180	300
ML5004	U		U	8	18,5	502	200	400
ML5005	U		U	8	18,5	509	200	420
ML5006	Y2		X2	8	18,5	550	212	230
ML5008	Y1		X1	8	18,5	365	140	600
ML5009	Y1		X1	8	18,5	600	255	180
ML5010	Y1		X1	8	18,5	600	255	200
ML5011	Y1		X1	8	18,5	600	255	360
ML5013	U		U	8	18,5	595	235	280
ML5014	U		U	8	18,5	584	234	280
ML5015	Y1		X1	8	18,5	549	229,5	350
ML5016	Y1		X2	8	18,5	549	229,5	240
ML5017	U		X2	8	18,5	362	135	190
ML5018	Y1		X1	8	18,5	256	86	280
ML5019	Y1		X1	8	18,5	600	250	500
ML5020	U		U	8	18,5	600	230	290
ML5021	U		U	8	18,5	700	251	200
ML5022	Y1		X1	8	18,5	696	278	220
ML5023	U		U	8	18,5	614	230	330
ML5024	U		C1	8	18,5	450	175	340
ML5025	U		U	8	18,5	450	175	260
ML5026	U		U	8	18,5	528	224	160
ML5028	U		U	8	18,5	460	170	220
ML5030	Y1		X1	8	18,5	256	86	180
ML5031	U		U	8	18,5	549	222	355
ML5032	U		U	8	18,5	473	188	530
ML5034	Y1		X1	8	18,5	585	250	200
ML5035	U		U	8	18,5	450	175	280
ML5036	Y1		X1	8	18,5	518	209	220
ML5037	U		P	8	18,5	700	300	325
ML5038	U		U	8	18,5	500	200	280
ML5039	Y1		X2	8	18,5	550	229,5	380
ML5040	U		U	8	18,5	569	220	280
ML5041	U		U	8	18,5	542	210	300
ML5042	Y1		X1	8	18,5	600	255	310
ML5043	Y1		X1	8	18,5	490	180	480
ML5044	U		U	8	18,5	527	219	450
ML5045	U		C1	8	18,5	405	160	550
ML5048	U		U	8	18,5	527	219	420
ML5049	U		C1	8	18,5	500	212	350
ML5051	S1		E1	10	22	726	280	420
ML5054	U		U	8	18,5	543,5	206	360
ML5055	Y1		X1	8	18,5	549,5	229,5	160
ML5056	Y1		X1	8	18,5	520	213	230
ML5057	P		S1	8	18,5	700	300	325
ML5061	U		C1	8	18,5	527	210	450
ML5063	U		U	8	18,5	284	100	315
ML5064	U		U	8	18,5	527	219	520
ML5065	U		U	8	18,5	600	245	430
ML5066	U		U	8	18,5	584	234	290
ML5067	Y1		X1	8	18,5	600	255	450
ML5068	U		U	8	18,5	515	202	370
ML5069	U		U	8	18,5	470	190	350
ML5072	U		U	8	18,5	502	200	280
ML5073	Y1		X1	8	18,5	501	207	480
ML5074	F1		Y3	10	22	798	350	500
ML5076	U		U	10	22	550	235	850
ML5077	U		C1	8	18,5	591	240	350
ML5078	U		U	8	18,5	507	205	420
ML5079	U		U	8	18,5	445	180	300
ML5080	U		U	8	18,5	495	192	500
ML5081	U		C1	8	18,5	569	242	210
ML5082	U		U	8	18,5	469,5	171	560
ML5085	U		U	10	22	249	67	850

Monroe®	C	↺	↻	Ød	ØD	Ext. L	S	F1
ML5086	S1		S1	8	18,5	526	207	570
ML5087	U		C1	8	18,5	473	172	420
ML5088	E2		E3	8	18,5	645	202,6	470
ML5089	E2		E3	8	18,5	645	202,6	470
ML5091	E4		T1	8	18,5	613,8	248	190
ML5092	E4		T1	8	18,5	613,8	248	190
ML5093	S1		S1	8	18,5	471	191	360
ML5094	U		U	8	18,5	500	204	500
ML5095	U		U	8	18,5	324	115	290
ML5096	U		U	8	18,5	447	172	500
ML5097	U		U	8	18,5	460	170	270
ML5098	P		P	8	18,5	496	188	270
ML5099	U		U	8	18,5	528	224	220
ML5100	S1		S1	8	18,5	500	204	480
ML5101	S1		S1	8	18,5	502	199	280
ML5102	Y1		V	8	18,5	788	342	280
ML5103	U		U	8	18,5	510	202	620
ML5104	U		S1	8	18,5	280	95,5	630
ML5105	U		U	10	22	569	240	910
ML5106	U		D	8	18,5	514,5	217	610
ML5107	U		U	8	18,5	602	252	430
ML5108	U		U	8	18,5	450	170	460
ML5109	U		U	8	18,5	544	207	495
ML5110	U		U	8	18,5	500	170	635
ML5111	U		C1	8	18,5	402	160	390
ML5113	T1		T1	8	18,5	700	300	670
ML5114	U		U	8	18,5	450	175	340
ML5115	U		U	8	18,5	500	200	400
ML5116	U		U	8	18,5	450	175	160
ML5118	P		P	10	22	685	250	770
ML5119	U		U	8	18,5	540	196	540
ML5120	U		C1	8	18,5	475	195	350
ML5121	S1		S1	8	18,5	450	175	600
ML5122	U		U	8	18,5	570	232	520
ML5123	S1		S1	8	18,5	515	210	500
ML5124	U		U	8	18,5	515	195	500
ML5125	U		U	8	18,5	508	195	600
ML5126	S1		U	8	18,5	554	200	515
ML5127	U		U	10	22	591	200	830
ML5128	S1		S1	10	22	690	280	630
ML5129	S1		S1	8	18,5	622	240	360
ML5130	U		C1	8	18,5	596,5	212	515
ML5131	U		C1	8	18,5	440	160	450
ML5132	S1		U	8	18,5	502	205	500
ML5133	U		U	8	18,5	600	250	250
ML5134	U		U	8	18,5	585	222	280
ML5135	U		U	8	18,5	279	95	490
ML5136	U		U	8	18,5	448	180	310
ML5137	U		U	8	18,5	542	193	590
ML5138	U		U	8	18,5	566	204	500
ML5139	S1		S1	8	18,5	602	250	160
ML5140	U		U	8	18,5	526	206	320
ML5141	U		U	10	22	567	221	590
ML5142	U		U	10	22	567	221	650
ML5143	U		U	8	18,5	574	235	260
ML5144	U		U	8	18,5	565	216	360
ML5145	U		C1	8	18,5	431	173	380
ML5146	S1		S1	8	18,5	510	210	340
ML5147	U		U	8	18,5	574	235	310
ML5148	U		U	8	18,5	600	230	300
ML5149	U		U	8	18,5	611	230	355
ML5151	U		U	8	18,5	445	162	420
ML5152	U		C1	8	18,5	595	250	485
ML5153	S1		S1	8	18,5	460	169	100

DIMENSION CHART

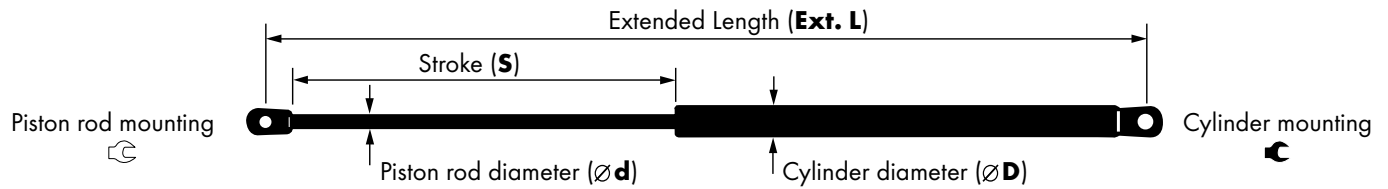

Monroe®	C	↺	Ød	ØD	Ext. L	S	F1
ML5154	U	U	8	18,5	298	83	500
ML5156	P	P	8	18,5	508	195	550
ML5157	U	U	10	22	540	200	450
ML5158	U	U	8	18,5	465	178	425
ML5159	S1	S1	8	18,5	485	190	320
ML5160	S1	S1	8	18,5	458	176	430
ML5161	U	U	8	18,5	534	216	410
ML5162	S1	S1	8	18,5	666,5	275	390
ML5163	S1	S1	8	18,5	350	100	320
ML5164	U	U	8	18,5	472	180	330
ML5165	U	U	8	18,5	455	164	380
ML5166	U	C1	8	18,5	536,5	205	430
ML5167	U	U	8	18,5	535	215	480
ML5168	U	U	8	18,5	512	200	550
ML5169	U	U	8	18,5	527	206	450
ML5170	U	U	8	18,5	295	80	480
ML5171	U	U	8	18,5	557	224	360
ML5172	U	U	8	18,5	557	224	425
ML5173	U	U	8	18,5	555	228	485
ML5175	U	C1	8	18,5	440	169	600
ML5176	S1	U	8	18,5	552	200	560
ML5177	U	U	8	18,5	515	210	550
ML5178	U	U	8	18,5	507	207	550
ML5179	S1	S1	6	15	305,5	121	45
ML5180	U	U	8	18,5	490	190	250
ML5181	S1	U	8	18,5	500	200	450
ML5182	S1	S1	8	18,5	300	100	410
ML5183	U	U	8	18,5	445	172	250
ML5184	S1	P	8	18,5	600,5	223	320
ML5185	S1	U	8	18,5	500	205	470
ML5188	U	U	8	18,5	540	214	400
ML5189	S1	S1	8	18,5	513	207	535
ML5190	S1	S1	8	18,5	513	207	585
ML5191	U	U	8	18,5	585	235	360
ML5192	U	U	8	18,5	680	270	360
ML5193	U	U	8	18,5	279	90	530
ML5194	S1	U	8	18,5	500	200	380
ML5195	S1	U	8	18,5	500	200	280
ML5196	S1	U	8	18,5	500	200	400
ML5197	S1	U	8	18,5	500	205	420
ML5198	S1	U	8	18,5	500	193	470
ML5199	S1	U	8	18,5	500	200	365
ML5200	U	U	8	18,5	577	226	415
ML5201	U	U	8	18,5	577	226	400
ML5202	U	U	8	18,5	566	230	440
ML5205	U	U	8	18,5	625	253	575
ML5206	U	U	8	18,5	599	190	425
ML5207	U	U	8	18,5	600	190	440
ML5208	U	U	8	18,5	552	205	370
ML5209	U	U	8	18,5	552	200	410
ML5210	U	U	8	18,5	440,5	158	370
ML5211	U	U	8	18,5	527	210	350
ML5212	U	U	8	18,5	417	155	500
ML5213	S1	S1	8	18,5	540	200	450
ML5214	S1	S1	8	18,5	517	200	460
ML5215	S1	S1	8	18,5	264	82	370
ML5216	S1	S1	8	18,5	264	82	460
ML5217	U	U	8	18,5	493	196	470
ML5218	U	U	8	18,5	495	198	500
ML5219	U	U	8	18,5	495	182	515
ML5221	U	U	8	18,5	495	182	565
ML5222	S1	U	8	18,5	440	171	370
ML5223	U	U	10	22	298	95	650
ML5224	U	K	10	22	465	140	655

Monroe®	C	↺	Ød	ØD	Ext. L	S	F1
ML5225	S1	U	8	18,5	500	200	470
ML5226	U	S1	10	22	260	89	690
ML5227	S1	S1	8	18,5	502	200	530
ML5228	U	K	10	22	560	210	730
ML5229	U	U	10	22	560	210	800
ML5230	S1	S1	6	15	447	170	130
ML5231	U	U	8	18,5	535	198	485
ML5232	U	U	8	18,5	535	198	520
ML5233	U	U	8	18,5	535	198	585
ML5234	U	U	10	22	278	90	630
ML5235	U	U	8	18,5	596	190	380
ML5236	U	U	8	18,5	596	195	430
ML5237	U	U	8	18,5	596	190	420
ML5238	S1	P	8	18,5	500	200	635
ML5239	P	U	10	22	500	195	690
ML5240	P	P	10	22	500	200	635
ML5241	U	U	8	18,5	412	155	340
ML5242	U	U	8	18,5	543,5	206	320
ML5243	U	U	8	18,5	549	232	320
ML5244	U	U	8	18,5	549	232	410
ML5245	U	U	10	22	569	240	750
ML5246	U	U	10	22	569	240	660
ML5247	U	U	10	22	569	240	830
ML5248	U	U	10	22	567	225	460
ML5249	P	P	10	22	685	250	710
ML5250	P	P	10	22	685	250	910
ML5251	P	P	10	22	685	250	830
ML5252	U	U	8	18,5	544	210	440
ML5253	U	U	8	18,5	496,5	192	565
ML5254	U	U	8	18,5	476,5	184	420
ML5255	U	U	8	18,5	600	250	320
ML5256	U	U	8	18,5	505	190	520
ML5257	U	U	8	18,5	470	182	600
ML5258	U	U	8	18,5	471	184	570
ML5259	U	U	8	18,5	287	99	365
ML5260	U	U	8	18,5	293	80	610
ML5261	S1	U	8	18,5	500	200	350
ML5262	U	U	8	18,5	595	250	450
ML5263	S1	S1	8	18,5	319	110	580
ML5264	S1	U	8	18,5	500	200	350
ML5265	U	U	8	18,5	585	235	250
ML5266	U	C1	8	18,5	722	306	280
ML5267	S1	S1	8	18,5	648	265	190
ML5268	U	U	8	18,5	685	285	180
ML5269	P	U	8	18,5	715	306	290
ML5270	U	U	8	18,5	460	160	300
ML5271	U	U	8	18,5	522	210	300
ML5272	U	U	8	18,5	522	210	400
ML5273	U	U	8	18,5	278	90	480
ML5274	U	U	8	18,5	278	90	430
ML5275	U	U	8	18,5	405	160	310
ML5276	U	U	8	18,5	529	215	245
ML5277	U	U	8	18,5	405	150	520
ML5278	U	U	8	18,5	570	240	520
ML5279	S1	U	8	18,5	595	210	470
ML5280	U	U	8	18,5	441,5	169	460
ML5281	U	U	8	18,5	506	200	380
ML5282	U	U	8	18,5	630	269	330
ML5283	U	U	8	18,5	627	230	570
ML5284	S1	U	8	18,5	500	200	320
ML5285	U	U	8	18,5	595	248	370
ML5286	U	U	8	18,5	591	239	400
ML5287	S1	U	8	18,5	500	200	190
ML5288	U	U	8	18,5	570	230	460

DIMENSION CHART

DIMENSION CHART

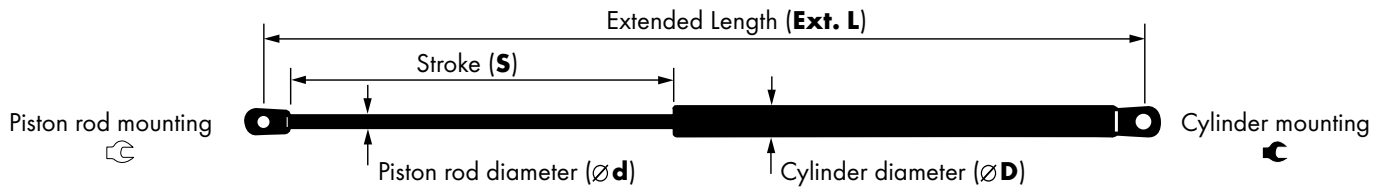

Monroe®	C	☞	Ød	ØD	Ext. L	S	F1
ML5289	U	U	8	18,5	556	205	500
ML5290	U	U	8	18,5	256	85	500
ML5291	U	U	8	18,5	501	175	595
ML5292	U	U	8	18,5	550	220	285
ML5293	U	U	8	18,5	485	196	460
ML5294	U	U	8	18,5	485	196	520
ML5295	U	U	8	18,5	678	282	480
ML5296	U	U	8	18,5	520	197	435
ML5297	U	U	8	18,5	435	160	100
ML5298	U	U	8	18,5	450	175	260
ML5299	U	U	8	18,5	602	252	430
ML5300	U	U	8	18,5	527	202	390
ML5301	U	U	8	18,5	295	100	380
ML5302	U	U	8	18,5	385	138	560
ML5303	S1	S1	8	18,5	365	135	620
ML5305	U	U	8	18,5	610	200	560
ML5306	U	U	8	18,5	500	196	225
ML5307	U	U	8	18,5	485	189	450
ML5308	U	U	8	18,5	450	170	490
ML5309	U	U	8	18,5	675	285	260
ML5310	U	U	8	18,5	310	89	590
ML5311	U	U	8	18,5	640	190	470
ML5312	U	U	8	18,5	545	230	300
ML5313	U	U	8	18,5	526	206	560
ML5314	U	U	8	18,5	545	220	530
ML5315	U	U	8	18,5	675	275	440
ML5316	U	U	8	18,5	408	150	310
ML5317	U	U	8	18,5	590	215	410
ML5318	U	U	8	18,5	590	215	450
ML5319	U	U	8	18,5	558	200	550
ML5320	U	U	8	18,5	600	225	450
ML5321	U	U	8	18,5	315	100	420
ML5322	U	U	8	18,5	315	100	465
ML5323	U	U	8	18,5	285	95	290
ML5324	U	U	8	18,5	590	220	480
ML5325	U	U	8	18,5	600	244	330
ML5327	U	U	8	18,5	540	220	250
ML5328	U	U	10	22	775	322	530
ML5329	U	U	10	22	772	322	630
ML5330	U	U	10	22	250	74	660
ML5331	U	K	10	22	450	162	740
ML5332	U	U	8	18,5	485	165	640
ML5333	Y1	D	8	18,5	668	280	375
ML5334	U	U	8	18,5	549,5	200	610
ML5335	S1	S1	8	18,5	310	110	580
ML5336	S1	S1	10	22	333	100	700
ML5337	U	U	8	18,5	691,5	285	270
ML5338	U	U	8	18,5	570	215	530
ML5339	S1	U	8	18,5	480	180	300
ML5340	U	U	8	18,5	525	210	140
ML5341	U	U	8	18,5	263	80	520
ML5342	U	U	8	18,5	575	235	330
ML5343	U	U	8	18,5	448	180	590
ML5344	U	U	8	18,5	632	230	510
ML5345	U	U	8	18,5	650	270	310
ML5346	U	U	8	18,5	571	208	570
ML5347	U	U	8	18,5	525	205	310
ML5348	U	U	8	18,5	525	205	350
ML5349	U	U	8	18,5	525	210	480
ML5350	U	U	8	18,5	525	210	240
ML5351	U	U	8	18,5	357	128	555
ML5352	U	U	8	18,5	268	78	510
ML5353	U	U	8	18,5	555	220	450
ML5354	U	U	8	18,5	570	230	490

Monroe®	C	☞	Ød	ØD	Ext. L	S	F1
ML5355	U	U	8	18,5	310	95	430
ML5356	U	U	8	18,5	352	110	150
ML5357	U	U	8	18,5	538	190	125
ML5358	U	U	8	18,5	500	171	400
ML5359	U	U	8	18,5	513	215	350
ML5360	U	U	8	18,5	500	190	360
ML5361	U	U	8	18,5	510	200	320
ML5362	U	U	8	18,5	507	208	436
ML5363	U	U	8	18,5	632	215	600
ML5364	U	U	8	18,5	635	248	360
ML5365	U	U	8	18,5	365	135	180
ML5366	U	U	8	18,5	365	135	240
ML5367	U	U	8	18,5	567,5	183	430
ML5368	S1	S1	8	18,5	750	315	300
ML5369	U	U	8	18,5	828	249	355
ML5370	U	P	8	18,5	510	200	370
ML5371	U	U	8	18,5	499	195	400
ML5372	U	U	8	18,5	546	215	500
ML5373	U	U	8	18,5	548	213	475
ML5374	U	U	8	18,5	556	225	475
ML5375	U	U	8	18,5	568	230	500
ML5376	U	S1	8	18,5	280	90	580
ML5377	U	S1	8	18,5	507	203	520
ML5378	U	S1	8	18,5	545	210	490
ML5379	U	S1	8	18,5	545	210	530
ML5380	U	S1	8	18,5	485	187	610
ML5381	U	S1	8	18,5	557	215	550
ML5382	U	S1	8	18,5	440	155	300
ML5383	U	S1	8	18,5	473,5	170	590
ML5384	U	S1	8	18,5	606,5	230	540
ML5385	U	X1	10	22	885	380	410
ML5386	U	U	8	18,5	722	315	325
ML5387	U	U	8	18,5	395	148	180
ML5388	U	U	8	18,5	565	215	480
ML5389	S1	S1	8	18,5	215	48	420
ML5390	U	U	8	18,5	508	194	350
ML5391	U	U	8	18,5	510	208	470
ML5392	S1	S1	8	18,5	400	149	300
ML5393	U	U	8	18,5	678	270	270
ML5394	U	U	8	18,5	600	226	360
ML5395	U	U	8	18,5	510	208	390
ML5396	U	U	8	18,5	568	213	360
ML5397	U	U	8	18,5	568	230	560
ML5398	U	U	8	18,5	580	245	340
ML5399	U	U	8	18,5	570	230	215
ML5400	U	U	8	18,5	570	230	420
ML5401	U	U	8	18,5	570	230	520
ML5402	U	U	8	18,5	570	240	470
ML5403	U	U	8	18,5	668	215	375
ML5404	U	U	8	18,5	240	74	300
ML5405	U	U	8	18,5	516	205	425
ML5406	U	U	8	18,5	498	197	330
ML5407	U	U	8	18,5	700	257	320
ML5408	U	U	8	18,5	511	199	520
ML5409	U	U	8	18,5	765	325	235
ML5410	S1	S1	8	18,5	515	200	445
ML5411	S1	U	8	18,5	315	105	370
ML5412	S1	U	8	18,5	565	210	560
ML5413	S1	U	8	18,5	472	175	590
ML5414	S1	S1	8	18,5	438	170	480
ML5415	U	U	10	22	455	127	700
ML5416	U	U	8	18,5	481,5	199	530
ML5417	S1	S1	8	18,5	275	90	590
ML5418	U	U	8	18,5	645,5	275	450

DIMENSION CHART

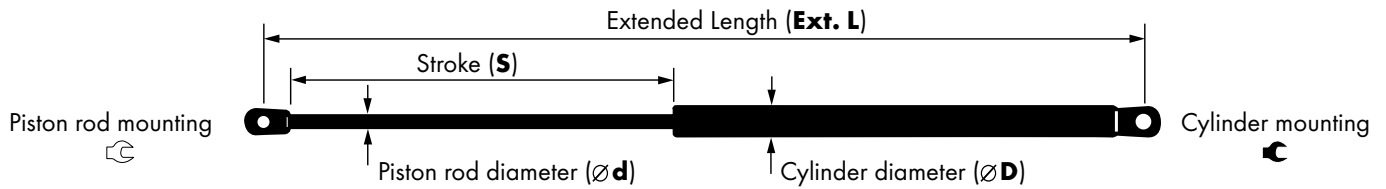

Monroe®	C	☉	Ød	ØD	Ext. L	S	F1
ML5419	S1	S1	8	18,5	280	95	390
ML5420	Y1	D	8	18,5	465	187	320
ML5421	10	10	6	15	367	145	320
ML5422	10	10	6	15	410	166	280
ML5424	U	S1	8	18,5	567	193	540
ML5425	U	C1	8	18,5	491	205	600
ML5426	U	U	10	22	418	148	700
ML5427	S1	U	8	18,5	471	185	380
ML5428	S1	S1	8	18,5	580	247	470
ML5429	U	U	10	22	550	235	810
ML5430	U	U	8	18,5	590,5	245	480
ML5431	U	U	8	18,5	256	85	630
ML5432	S1	S1	8	18,5	624	260	400
ML5433	U	U	10	22	520	180	665
ML5434	U	U	8	18,5	599	220	360
ML5435	S1	S1	8	18,5	656	260	400
ML5436	S1	S1	8	18,5	517	190	420
ML5437	S1	U	8	18,5	575	220	500
ML5438	S1	S1	8	18,5	459,5	180	535
ML5439	U	U	8	18,5	279	95	520
ML5440	S1	S1	8	18,5	534,5	220	480
ML5441	S1	S1	10	22	326	115	800
ML5442	U	U	8	18,5	348	120	620
ML5443	U	U	10	22	603	220	740
ML5444	10	10	8	18,5	365	145	410
ML5445	10	10	8	18,5	365	145	480
ML5446	T1	T1	10	22	382	140	660
ML5447	T1	T1	8	18,5	540	130	170
ML5448	U	U	10	22	866	350	370
ML5449	U	U	8	18,5	405	160	620
ML5450	U	U	8	18,5	635	259	290
ML5452	U	U	8	18,5	653	260	460
ML5453	U	U	8	18,5	460	180	380
ML5454	U	U	8	18,5	627	230	630
ML5455	U	U	8	18,5	632	215	600
ML5456	U	U	8	18,5	610	200	600
ML5457	U	U	8	18,5	546	225	220
ML5458	U	U	8	18,5	631	230	440
ML5459	S1	S1	8	18,5	485	193	460
ML5460	S1	S1	8	18,5	494	185	490
ML5461	S1	S1	8	18,5	506	205	180
ML5462	S1	S1	8	18,5	477	188	360
ML5463	S1	S1	8	18,5	577	226	275
ML5464	S1	S1	8	18,5	577	226	320
ML5465	S1	S1	8	18,5	614	229	300
ML5466	S1	S1	8	18,5	280	80	465
ML5467	S1	S1	8	18,5	280	80	420
ML5469	S1	S1	8	18,5	581,5	210	535
ML5470	S1	S1	8	18,5	685	265	200
ML5471	S1	S1	8	18,5	286	100	310
ML5472	S1	S1	8	18,5	395	150	230
ML5473	S1	S1	8	18,5	395	150	470
ML5474	S1	S1	8	18,5	535	220	425
ML5475	U	U	8	18,5	520	175	640
ML5476	S1	S1	8	18,5	574,5	230	530
ML5477	S1	S1	8	18,5	574,5	230	620
ML5478	S1	S1	8	18,5	515	200	490
ML5480	S1	S1	8	18,5	452	177	350
ML5481	S1	S1	8	18,5	270	75	420
ML5482	S1	S1	8	18,5	575	230	440
ML5483	S1	S1	8	18,5	280	95	500
ML5484	S1	S1	8	18,5	400	150	280
ML5485	S1	U	8	18,5	468	163	440
ML5486	S1	S1	8	18,5	434	153	585

Monroe®	C	☉	Ød	ØD	Ext. L	S	F1
ML5487	S1	S1	8	18,5	298	90	600
ML5488	S1	S1	8	18,5	320	100	360
ML5489	S1	S1	8	18,5	364	132	310
ML5490	S1	S1	8	18,5	363	132	370
ML5491	S1	U	8	18,5	500	200	310
ML5492	Y1	D	8	18,5	465	169	113
ML5493	S1	S1	8	18,5	558	200	135
ML5494	Y1	D	8	18,5	700	295	400
ML5495	U	U	8	18,5	490	195	610
ML5496	Y1	D	8	18,5	226	63	100
ML5499	Y1	D	8	18,5	700	295	345
ML5500	S1	S1	8	18,5	430	160	470
ML5501	Y2	D	8	18,5	600	250	540
ML5502	S1	S1	8	18,5	300	99	560
ML5503	T1	T1	8	18,5	600	215	510
ML5504	T1	T1	8	18,5	600	215	550
ML5505	T1	T1	8	18,5	630	220	570
ML5506	T1	T1	8	18,5	540	220	490
ML5507	T1	T1	8	18,5	433	165	500
ML5508	T1	T1	8	18,5	680	270	390
ML5509	T1	T1	8	18,5	534	217	200
ML5510	U	U	10	22	483	175	740
ML5511	U	U	10	22	483	175	690
ML5512	U	U	10	22	480	173	690
ML5513	T1	T1	10	22	382	140	660
ML5514	U	U	10	22	850	340	670
ML5515	U	U	10	22	722	210	819
ML5516	T1	T1	10	22	905	307	730
ML5517	U	U	10	22	195	55	1100
ML5518	U	U	10	22	730	200	700
ML5519	U	U	10	22	730	200	760
ML5521	T1	Q	8	18,5	665	270	360
ML5522	10	10	8	18,5	242	84	380
ML5523	S1	12	8	18,5	312	100	640
ML5524	T1	T1	10	22	273	92	680
ML5525	T1	T1	10	22	273	92	720
ML5526	S1	14	8	18,5	178	55	480
ML5527	O	O	10	22	613,5	248	620
ML5528	M	O	10	22	697	257	610
ML5529	O	M	14	28	270	70	1600
ML5530	U	P	8	18,5	640	260	510
ML5531	S1	T1	8	18,5	280	90	500
ML5532	S1	T1	8	18,5	280	90	600
ML5533	T1	T1	10	22	272	90	670
ML5534	S1	U	8	18,5	605	247	340
ML5535	Y1	T1	8	18,5	241	70	560
ML5536	U	Q	8	18,5	288	95	250
ML5537	U	U	10	22	603	198	810
ML5538	U	U	10	22	603	198	850
ML5539	U	U	10	22	489	144	720
ML5540	S2	S2	10	22	364	130	800
ML5541	S1	S1	8	18,5	568	215	410
ML5542	U	U	8	18,5	667	215	375
ML5543	U	U	8	18,5	695	272	640
ML5544	U	S1	8	18,5	596	210	450
ML5545	U	S1	8	18,5	596	210	510
ML5546	R	R	6	15	185	55	100
ML5547	S1	S1	6	15	502	200	125
ML5548	S1	S1	6	15	530	213	110
ML5549	T1	D	8	18,5	270	90	540
ML5550	T1	T1	10	22	905	307	730
ML5551	S1	S1	6	15	547	190	170
ML5552	S1	S1	6	15	365	135	135
ML5553	U	U	10	22	310	89	650

DIMENSION CHART

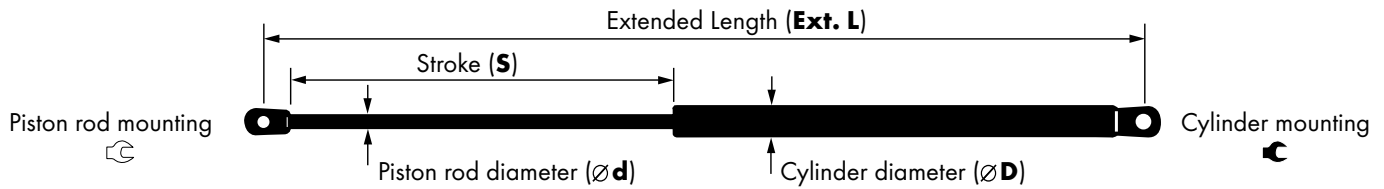

Monroe®	C	☰	Ød	ØD	Ext. L	S	F1
ML5554	U	T1	10	22	573,5	215	580
ML5555	U	T1	10	22	573,5	215	670
ML5556	Y1	X1	6	15	547	214	225
ML5557	U	U	10	22	492	188	710
ML5558	U	T1	8	18,5	280	90	550
ML5559	U	S2	10	22	235	52	850
ML5560	U	13	8	18,5	525	200	280
ML5561	U	U	8	18,5	687	295	270
ML5562	S1	S1	8	18,5	313	112	330
ML5563	S1	S1	8	18,5	374	140	350
ML5564	U	P	8	18,5	577	225	270
ML5565	P	S1	8	18,5	715	303	160
ML5566	10	10	8	18,5	254	90	420
ML5567	S1	S1	8	18,5	635	225	200
ML5568	S1	S1	8	18,5	464	166	160
ML5569	S1	S1	8	18,5	485	185	580
ML5570	S1	S1	8	18,5	490	187	380
ML5571	T1	T1	8	18,5	550	222	475
ML5572	Y1	U	8	18,5	500	190	220
ML5573	U	D	8	18,5	640	235	390
ML5574	U	D	8	18,5	500	200	270
ML5575	U	P	10	22	755	210	970
ML5576	U	U	10	22	755	210	1080
ML5577	U	13	8	18,5	563	200	280
ML5578	U	U	8	18,5	650	250	460
ML5579	S1	S1	8	18,5	523	202	530
ML5580	U	U	10	22	520	185	730
ML5581	U	U	10	22	527	200	660
ML5582	U	U	10	22	769	247	475
ML5583	U	U	10	22	195	50	760
ML5584	S1	U	10	22	870	370	370
ML5585	O	O	10	22	613,5	248	560
ML5586	O	O	10	22	613,5	248	640
ML5587	S1	S1	8	18,5	459	172	230
ML5588	S1	S1	8	18,5	559	220	330
ML5589	S1	S1	8	18,5	671,5	270	360
ML5590	S1	12	8	18,5	346	100	520
ML5591	U	Q	10	22	545	195	750
ML5592	S1	S1	8	18,5	498	225	540
ML5593	Y1	D	8	18,5	615	260	400
ML5594	Y5	X3	8	18,5	255	86	600
ML5595	Y5	X3	8	18,5	255	86	370
ML5596	Y4	X1	6	15	254	95	350
ML5597	U	X1	8	18,5	547	230	230
ML5598	S1	S1	8	18,5	600	250	160
ML5599	Y1	X1	6	15	440	142	380
ML5600	Y1	D	8	18,5	500	200	230
ML5603	Y1	D	8	18,5	650	275	310
ML5605	S1	D	8	18,5	650	275	310
ML5606	Y1	D	8	18,5	579	235	320
ML5607	S1	S1	8	18,5	544	224	250
ML5608	N	N	8	18,5	675	279	210
ML5609	W	D	8	18,5	580	245	380
ML5611	Y1	D	8	18,5	245	76	330
ML5612	U	U	10	22	501	175	780
ML5613	Y1	D	8	18,5	500	201	600
ML5615	U	P	8	18,5	502	195	400
ML5616	S1	U	8	18,5	570	200	630
ML5617	N	N	8	18,5	268	83,5	450
ML5618	N	N	8	18,5	505	180	430
ML5619	N	N	8	18,5	330	116	340
ML5620	U	U	8	18,5	580	205	230
ML5621	U	U	10	22	775	322	530
ML5622	S1	S1	8	18,5	515	187	490

Monroe®	C	☰	Ød	ØD	Ext. L	S	F1
ML5623	S1	S1	8	18,5	398	120	180
ML5624	P	T1	8	18,5	392	150	300
ML5625	Y1	U	8	18,5	419	165	360
ML5626	U	U	8	18,5	627	230	570
ML5627	U	U	8	18,5	610	200	560
ML5628	U	U	10	22	265	80	820
ML5629	R	R	6	15	225	80	100
ML5630	S1	S1	10	22	431	121	680
ML5631	T1	T1	8	18,5	677	274	340
ML5632	Y1	D	8	18,5	486	170	585
ML5633	Y1	D	8	18,5	268	90	540
ML5634	T1	T1	8	18,5	680	270	360
ML5635	Y1	D	8	18,5	500	195	650
ML5636	U	U	8	18,5	525	210	240
ML5637	O	O	14	28	396	108	1550
ML5638	U	U	8	18,5	765	324	200
ML5639	Y1	D	8	18,5	254	85	340
ML5640	T1	T1	6	15	305	109	130
ML5641	S1	S1	8	18,5	511,5	172	545
ML5642	T1	T1	8	18,5	550	200	460
ML5643	S1	S1	6	15	244	90	400
ML5644	T1	D	8	18,5	515	215	550
ML5645	Y1	U	8	18,5	512	200	300
ML5646	Y5	X3	8	18,5	319	100	370
ML5647	P	S1	8	18,5	485	200	565
ML5648	P	U	8	18,5	728	310	265
ML5649	U	U	8	18,5	405	160	300
ML5650	P	U	8	18,5	484	190	200
ML5651	P	U	8	18,5	544	218	290
ML5652	J	S1	8	18,5	375	135	495
ML5653	S1	U	8	18,5	439,5	157	550
ML5654	U	U	8	18,5	657	275	480
ML5655	S1	U	8	18,5	456	165	320
ML5656	P	P	8	18,5	469,5	185	580
ML5657	S1	S1	8	18,5	495	205	610
ML5658	S1	S1	8	18,5	369	110	320
ML5659	S1	S1	8	18,5	553	225	220
ML5660	P	U	8	18,5	441	175	300
ML5661	U	U	8	18,5	440	170	470
ML5662	U	U	8	18,5	590	245	460
ML5663	U	U	8	18,5	283	101,5	450
ML5664	U	U	8	18,5	585	240	420
ML5665	U	U	8	18,5	585,5	245	405
ML5666	U	U	8	18,5	531	173	545
ML5667	U	U	8	18,5	490,5	200	480
ML5668	S1	U	8	18,5	545	195	425
ML5669	U	U	8	18,5	424,5	165	450
ML5670	S1	S1	8	18,5	366	117	280
ML5671	U	U	8	18,5	627	205	660
ML5672	U	U	8	18,5	540	210	385
ML5673	U	U	8	18,5	582	203	460
ML5674	1	1	14	28	325	100	1400
ML5675	U	U	10	22	175	45	700
ML5676	U	U	8	18,5	436	175	150
ML5677	Y1	T1	8	18,5	499	205	460
ML5678	U	L	10	22	943	417	380
ML5679	L	L	8	18,5	722	306	310
ML5680	U	U	8	18,5	350	130	440
ML5681	U	U	8	18,5	495	205	440
ML5682	U	U	8	18,5	420	162	600
ML5683	P	U	8	18,5	580	201	510
ML5684	U	U	8	18,5	515	190	490
ML5685	M	O	14	28	320	85	1200
ML5686	U	U	8	18,5	165	40	650

DIMENSION CHART

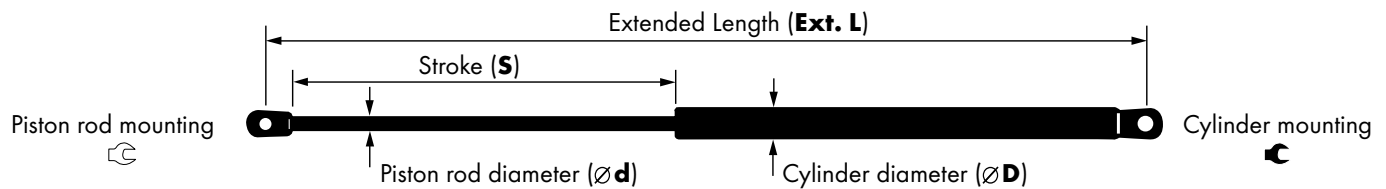

Monroe®	C	☞	Ød	ØD	Ext. L	S	F1
ML5687	U	U	8	18,5	555	228	305
ML5688	S1	S1	8	18,5	288	104	640
ML5689	S1	P	8	18,5	400	160	330
ML5690	S1	S1	8	18,5	530	175	530
ML5691	S1	U	8	18,5	412	163	400
ML5692	U	U	8	18,5	545	210	450
ML5693	P	S1	8	18,5	625	210	590
ML5694	S1	S1	8	18,5	370	110	320
ML5695	S1	U	8	18,5	425	165	350
ML5696	P	U	8	18,5	355	120	350
ML5697	U	U	8	18,5	604	253	250
ML5698	S1	U	8	18,5	291	107	380
ML5699	P	S1	8	18,5	445	183	550
ML5700	U	U	8	18,5	480	173	135
ML5701	S1	U	8	18,5	590	176	435
ML5702	P	S1	8	18,5	470	185	480
ML5703	P	U	8	18,5	480	190	420
ML5704	T1	T1	8	18,5	378	145	540
ML5705	S1	U	8	18,5	565	240	290
ML5706	P	U	8	18,5	395	158	440
ML5707	U	U	8	18,5	545	210	620
ML5708	U	U	8	18,5	480	195	335
ML5709	U	U	10	22	736,5	310	725
ML5710	U	U	8	18,5	299	109	550
ML5711	U	U	8	18,5	515	210	490
ML5712	P	U	8	18,5	490	200	380
ML5713	U	U	8	18,5	515	215	400
ML5714	U	P	8	18,5	386,5	150	350
ML5715	U	C1	8	18,5	650	270	350
ML5716	U	U	10	22	667	255	755
ML5717	P	U	8	18,5	497	200	430
ML5718	U	U	10	22	547	220	460
ML5719	U	P	8	18,5	475	175	510
ML5720	U	U	8	18,5	543	220	310
ML5721	U	U	8	18,5	474	190	570
ML5722	U	U	10	22	505	205	610
ML5723	S1	S1	8	18,5	405	160	480
ML5724	S1	S1	8	18,5	533	200	515
ML5725	S1	S1	8	18,5	451	185	385
ML5726	U	U	8	18,5	730	316	140
ML5727	U	U	8	18,5	320	105	470
ML5728	U	U	8	18,5	375	145	615
ML5729	U	U	8	18,5	310	110	400
ML5730	U	U	8	18,5	565	215	315
ML5731	S1	P	8	18,5	505	211	330
ML5732	S1	S1	8	18,5	505	195	490
ML5733	S1	S1	6	15	435	180	105
ML5734	S1	S1	8	18,5	460	180	440
ML5735	P	U	8	18,5	730	320	250
ML5736	S1	U	8	18,5	404,5	163	460
ML5737	P	U	8	18,5	720	300	180
ML5738	P	U	8	18,5	735	321	300
ML5739	U	P	8	18,5	485	200	170
ML5740	S1	U	8	18,5	315	120	440
ML5741	U	U	8	18,5	765	335	340
ML5742	S1	U	8	18,5	450	180	535
ML5743	U	P	10	22	505	170	770
ML5744	U	U	10	22	298	80	730
ML5745	U	U	10	22	298	80	700
ML5746	U	P	8	18,5	475	184	650
ML5747	T1	T1	8	18,5	490	198	530
ML5748	S1	U	8	18,5	255	85	600
ML5749	U	P	8	18,5	530	210	410
ML5750	U	U	10	22	720	280	870

Monroe®	C	☞	Ød	ØD	Ext. L	S	F1
ML5751	T1	T1	10	22	300	70	710
ML5752	U	U	8	18,5	500	208	375
ML5753	U	U	8	18,5	470	160	630
ML5754	U	P	8	18,5	528	212	420
ML5755	U	P	8	18,5	640	255	595
ML5756	U	P	8	18,5	640	255	565
ML5757	U	U	8	18,5	473	182	540
ML5758	P	U	8	18,5	726,5	310	360
ML5759	T1	T1	8	18,5	483	191	370
ML5760	P	U	8	18,5	515	196	585
ML5761	U	U	8	18,5	305	105	550
ML5762	P	U	8	18,5	385	150	140
ML5763	T1	T1	8	18,5	540	225	390
ML5764	U	U	8	18,5	252	85	425
ML5765	T1	T1	8	18,5	565	220	500
ML5766	S1	S1	8	18,5	318	120	380
ML5767	S1	U	8	18,5	500	195	340
ML5768	U	U	8	18,5	721,5	315	350
ML5769	U	S1	10	22	285	100	720
ML5770	P	P	8	18,5	605	242	655
ML5771	P	P	10	22	574	198	990
ML5772	T1	P	8	18,5	539	218	585
ML5773	U	U	8	18,5	475	195	640
ML5774	T1	P	8	18,5	500	200	525
ML5775	S1	S1	8	18,5	437	173	350
ML5776	U	P	8	18,5	495	197	420
ML5777	U	U	8	18,5	430	170	370
ML5778	S1	U	8	18,5	285	105	600
ML5779	U	U	8	18,5	445	160	420
ML5780	T1	T1	8	18,5	550	235	280
ML5781	U	S1	10	22	535	183	710
ML5782	T1	T1	8	18,5	558	235	500
ML5783	U	P	8	18,5	585	190	625
ML5784	U	U	8	18,5	510	213	360
ML5785	S1	S1	8	18,5	460	170	350
ML5786	U	U	8	18,5	280	90	510
ML5787	T1	T1	10	22	550	160	710
ML5788	T1	T1	8	18,5	554	185	200
ML5789	U	U	8	18,5	345	122	350
ML5790	P	S1	8	18,5	740	310	290
ML5791	S1	U	8	18,5	201	52	250
ML5792	U	P	8	18,5	480	200	550
ML5793	S1	S1	8	18,5	315	100	550
ML5794	T1	T1	8	18,5	462,5	190	560
ML5795	U	U	8	18,5	628	272	440
ML5796	S1	U	8	18,5	463	185	360
ML5797	T1	T1	10	22	556	224	715
ML5798	U	U	8	18,5	674	293	300
ML5799	U	U	8	18,5	674	293	330
ML5800	U	U	8	18,5	333	117	650
ML5801	U	U	8	18,5	415	160	530
ML5802	U	U	8	18,5	418	163	490
ML5803	S1	S1	8	18,5	240	70	380
ML5804	U	U	8	18,5	314,5	116	330
ML5805	P	U	8	18,5	479	179	340
ML5806	U	P	10	22	560	178	725
ML5807	U	U	8	18,5	609,5	251,5	245
ML5808	S1	S1	8	18,5	256	58	560
ML5809	S1	S1	8	18,5	536	204	410
ML5810	U	U	8	18,5	238	62	165
ML5811	U	U	8	18,5	323	103	700
ML5812	U	U	8	18,5	520	208	130
ML5813	S1	S1	6	15	297	112,5	240
ML5814	U	U	8	18,5	447	175	300

DIMENSION CHART

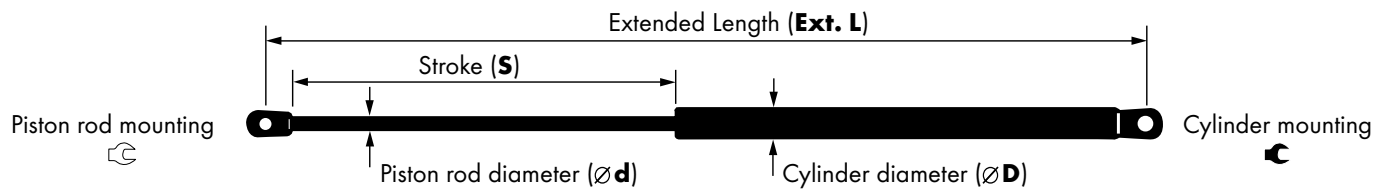

Monroe®	C	☞	$\varnothing d$	$\varnothing D$	Ext. L	S	F1
ML5815	U	U	8	18,5	600	228	360
ML5816	T1	T1	10	22	570	240	650
ML5817	P	U	10	22	482	185,5	700
ML5818	U	U	8	18,5	282	98	560
ML5819	U	U	8	18,5	568	233	330
ML5820	U	U	8	18,5	613	260	300
ML5821	S1	U	8	18,5	500	203	245
ML5822	S1	S1	8	18,5	580	245	165
ML5823	S1	S1	6	15	362	138	100
ML5824	S1	S1	8	18,5	558	235	530
ML5825	S1	S1	8	18,5	500	230	135
ML5826	U	C1	8	18,5	520	180	625
ML5827	U	U	8	18,5	603	255	240
ML5828	U	P	8	18,5	547	220	550
ML5829	P	U	8	18,5	730	310	380
ML5830	U	P	8	18,5	375	140	390
ML5831	U	S1	8	18,5	450	180	550
ML5832	U	P	8	18,5	390	155	360
ML5833	U	P	10	22	755	210	1080
ML5834	M	O	10	22	699	257	610
ML5835	M	O	10	22	699	257	540
ML5836	T1	T1	8	18,5	639	258	465
ML5837	T1	T1	8	18,5	690	300	630
ML5838	P	P	8	18,5	494	172	500
ML5839	U	K	10	22	390	148	800
ML5840	I	H	6	15	465	190	335
ML5842	S2	15	8	18,5	585	235	310
ML5843	S2	16	8	18,5	585	235	310
ML5844	U	U	8	18,5	310	110	590
ML5845	U	U	8	18,5	419	165	510
ML5846	U	D	8	18,5	405	164	270
ML5847	B2	A2	10	22	610	240	500
ML5848	B1	A1	10	22	610	240	500
ML5849	U	U	8	18,5	526	220	325
ML5850	S1	P	8	18,5	559	230	290
ML5851	S1	S1	8	18,5	631	265	455
ML5852	G	G	14	28	399	86	1340
ML5855	S1	S1	8	18,5	400	139	400
ML5856	U	U	8	18,5	500	190	600
ML5857	P	P	8	18,5	500	190	500
ML5860	S1	S1	8	18,5	214	62	680
ML5861	S1	S1	8	18,5	296	95	250
ML5862	S1	S1	8	19	548	220	420
ML5864	U	U	8	18,5	519	184	370
ML5866	U	P	10	22	625	210	510
ML5867	U	U	8	18,5	460,5	174	350
ML5868	U	P	8	18,5	414	150	430
ML5869	U	P	8	18,5	569	240	310
ML5870	S1	S1	6	15	400	160	230
ML5871	S1	S1	8	18,5	480	185	480
ML5872	S1	S1	8	18,5	516,5	150	580
ML5873	U	P	8	18,5	514	180	335
ML5888	T1	T1	8	18,5	585,5	235	510
ML5889	S1	S1	8	18,5	527	188	620
ML5890	S1	S1	8	18,5	515	210	365
ML5891	S1	S1	8	18,5	383	137	455
ML5892	S1	S1	8	18,5	830	300	560
ML5893	S1	S1	8	18,5	569	240	670
ML5894	U	U	8	18,5	446	170	490
ML5895	U	U	8	18,5	532,5	190	360
ML5900	S1	S1	8	18,5	443,5	165	455
ML5906	I	H	6	15	365,5	150	290
ML5907	S1	S3	8	18,5	481	183	360
ML5909	I	U	8	18,5	496,5	195	340

Monroe®	C	☞	$\varnothing d$	$\varnothing D$	Ext. L	S	F1
ML5910	U	S1	8	18,5	355	135	115
ML5911	T1	T1	10	22	414	155	500
ML5912	S1	U	8	18,5	567	195	550
ML5917	S1	S1	8	18,5	493	195	445
ML5918	U	U	8	18,5	502	205	530
ML5919	Y1	D	8	18,5	615	243	240
ML5920	U	U	8	18,5	470	180	350
ML5921	S1	S1	8	18,5	270	82	380
ML5922	S1	S3	8	18,5	255	78	350
ML5923	U	U	8	18,5	502	205	450
ML5924	U	C1	8	18,5	375	144	280
ML5925	U	C1	8	18,5	408	152	390
ML5926	U	C1	8	18,5	408	152	265
ML5927	U	T1	8	18,5	274	90	740
ML5928	S1	S1	8	18,5	305	96	410
ML5929	P	P	10	22	498	191	630
ML5930	U	U	8	18,5	331	115	520
ML5932	S1	S1	8	18,5	291	65	540
ML5934	10	10	8	18,5	254	95	490
ML5936	P	U	8	18,5	410	155	390
ML5938	S1	U	8	18,5	672	240	180
ML5939	U	U	8	18,5	427	165	240
ML5940	S1	S1	8	18,5	585	246	500
ML5941	S1	S1	8	18,5	449	179	520
ML5943	S1	S3	8	18,5	376	145	390
ML5944	P	P	10	22	430,5	130	1050
ML5945	P	U	6	15	314	110	355
ML5946	U	C	8	18,5	293	104	280
ML5947	P	P	10	22	665	195	765
ML5948	U	S1	10	22	620	225	625
ML5950	U	U	10	22	700	172	1050
ML5954	U	U	8	18,5	543	220	200
ML5956	S1	S3	8	18,5	563	235	140
ML5958	U	P	8	18,5	588	198	645
ML5959	S1	S1	8	18,5	589	240	110
ML5961	S1	S3	8	18,5	526,5	208	125
ML5962	U	C1	8	18,5	313,5	78,5	495
ML5963	S1	S1	8	18,5	495	180,5	570
ML5967	S1	S1	8	18,5	387	139	465
ML5968	U	U	8	18,5	600	225	670
ML5973	S1	S1	8	18,5	565	200	200
ML5974	T1	T1	6	15	155	40	400
ML5975	S1	S3	8	18,5	288,5	100	380
ML5976	N	N	8	18,5	673	276	250
ML5977	S1	S1	8	18,5	418,5	155	390
ML5978	S1	S1	8	18,5	201	60	450
ML5979	U	U	8	18,5	490	189	560
ML5980	U	U	8	18,5	285	104	230
ML5981	U	U	8	18,5	431	100	400
ML5982	1	1	14	28	342	105	1200
ML5983	U	P	10	22	524	212	540
ML5984	U	P	10	22	524	212	585
ML5985	T1	T1	10	22	512	200	520
ML5986	S1	C1	8	18,5	577	190	530
ML5987	U	S1	8	18,5	449	160	470
ML5989	U	K	10	22	595	205	680
ML5990	U	U	8	18,5	512	198	460
ML5991	U	U	8	18,5	557	220	580
ML5992	P	U	8	18,5	436	154	245
ML5994	U	C1	8	18,5	345	119	510
ML5995	U	P	8	18,5	494	194	250
ML5996	U	C1	8	18,5	300	106,5	460
ML5997	P	S1	8	18,5	505	205	585
ML5998	C	U	8	18,5	380	127	200

DIMENSION CHART

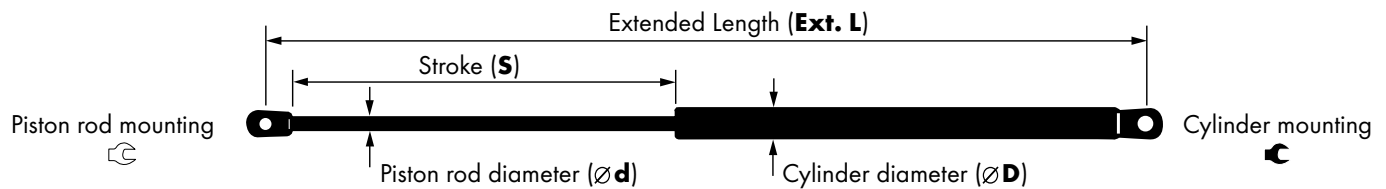

Monroe®	C	⌘	$\varnothing d$	$\varnothing D$	Ext. L	S	F1
ML5999	U	U	6	15	346	136	340
ML6000	U	U	8	18,5	285	105	460
ML6001	Q	Q	10	22	429	136	838
ML6002	U	U	10	22	569,5	155	590
ML6003	U	P	8	18,5	644	265	300
ML6004	S1	S1	8	18,5	292	88	410
ML6005	S1	S1	8	18,5	538	220	510
ML6006	U	U	8	18,5	319,5	120	410
ML6008	S1	S1	8	18,5	516	184	160
ML6009	S1	S1	8	18,5	456	182	185
ML6011	U	U	8	18,5	273	85	420
ML6012	P	P	10	22	496	180	635
ML6013	S1	S1	10	22	515,5	205	610
ML6014	U	K	8	18,5	287	89	495
ML6015	U	U	8	18,5	232,5	65	305
ML6016	U	S3	8	18,5	479	174	580
ML6017	U	U	8	18,5	604	225	510
ML6019	U	U	8	18,5	222,5	71	500
ML6020	S1	10	6	15	289	113	350
ML6021	1	1	14	28	347,5	91,5	1300
ML6022	U	C1	8	18,5	506,5	186	485
ML6023	U	C1	8	18,5	506,5	186	515
ML6024	P	13	8	18,5	533	216	330
ML6025	P	13	8	18,5	570	254	330
ML6026	U	13	8	18,5	394	149	400
ML6027	U	13	8	18,5	429	149	400
ML6028	S1	12	8	18,5	397	158	295
ML6029	U	13	10	22	301	92	730
ML6030	M	M	14	28	312,5	75,5	1450
ML6031	S1	10	6	15	242	74	325
ML6032	U	13	10	22	874	404	260
ML6033	U	U	8	18,5	338	119	420
ML6035	P	P	8	18,5	386,5	145	160
ML6036	U	U	8	18,5	495	190	370
ML6037	U	C1	8	18,5	241	76	700
ML6038	T1	T1	10	22	500	175	630
ML6039	T1	T1	10	22	742	277	400
ML6040	U	U	8	18,5	549	219	290
ML6041	T1	T1	10	22	600	220	325
ML6042	S1	S1	8	18,5	580	200	560
ML6043	U	U	8	18,5	499	145	150
ML6044	S1	S1	8	18,5	643	204	475
ML6046	U	U	8	18,5	431	173	320
ML6047	S1	S1	8	18,5	283	87	400
ML6049	U	U	8	18,5	721,5	313	180
ML6051	U	U	8	18,5	500	146	660
ML6053	U	C1	8	18,5	652	218	750
ML6055	U	U	10	22	661,5	260,5	800
ML6057	U	C1	10	22	598,5	186	700
ML6058	S1	S1	10	22	537	198	750
ML6060	S1	S1	8	18,5	584	250	150
ML6061	U	U	8	18,5	404	157	260
ML6062	S1	D	8	18,5	305	105	370
ML6063	S1	P	6	15	334	130	270
ML6065	U	C1	8	18,5	314,5	116	220
ML6066	S1	S1	6	15	195,5	60	350
ML6067	S1	S1	8	18,5	195,5	36	500
ML6068	U	C1	8	18,5	227	57	790
ML6069	U	P	8	18,5	585	246	260
ML6070	U	C1	8	18,5	585	250	430
ML6071	U	U	8	18,5	431	160	600
ML6072	U	U	8	18,5	664	275	265
ML6073	U	U	8	18,5	482,5	195	705
ML6074	U	Q	8	18,5	663,5	271	315

Monroe®	C	⌘	$\varnothing d$	$\varnothing D$	Ext. L	S	F1
ML6075	U	K	10	22	533	220	750
ML6076	U	T1	10	22	282	100	680
ML6079	P	U	8	18,5	728	310	315
ML6080	U	U	8	18,5	538	205	650
ML6081	S1	S1	8	18,5	404,5	160	310
ML6082	S1	S1	8	18,5	435	175	170
ML6083	S1	S3	8	18,5	445	176	90
ML6084	T1	T1	8	18,5	414	160	410
ML6085	11	11	8	18,5	587	235	100
ML6086	U	U	8	18,5	439,5	155	410
ML6087	S1	S1	8	18,5	495	180,5	510
ML6089	T1	T1	8	18,5	611	228	420
ML6090	I	H	6	15	359	150	180
ML6091	U	U	8	18,5	291	91	600
ML6092	O	M	14	28	308	88	1190
ML6094	S2	S2	8	18,5	299,5	88	370
ML6096	P	U	8	18,5	690	280	380
ML6097	S1	S1	8	18,5	334	120	610
ML6098	S1	U	8	18,5	344,5	88,5	450
ML6099	S1	U	8	18,5	344,5	88,5	565
ML6100	U	U	8	18,5	457	167	320
ML6101	S1	S1	6	15	285	100	300
ML6102	U	P	10	22	483,5	148	750
ML6103	U	C1	8	19	319,5	91	480
ML6104	U	C1	8	18,5	299	65,5	670
ML6105	S1	S1	6	15	445	175	110
ML6106	U	C1	8	18,5	287	96	520
ML6107	S1	S3	8	19	290	102	395
ML6108	S1	S1	8	19	345	128	450
ML6109	U	U	8	19	567	228	460
ML6110	S1	S3	8	18,5	283	84	570
ML6111	S1	C1	8	18,5	694	294	220
ML6112	U	C	8	18,5	298	94	430
ML6113	Q	Q	10	22	539	163	690
ML6114	S1	H1	6	15	310	122	255
ML6115	U	C1	8	18,5	492	175	475
ML6116	U	C1	8	18,5	527	163	610
ML6117	U	C1	8	18,5	527	163	535
ML6118	U	C1	8	18,5	340	113	430
ML6119	U	C1	8	18,5	480	189	600
ML6120	U	U	8	18,5	280	95	395
ML6121	U	C1	8	18,5	285	100	580
ML6122	P	P	8	19	588	204	400
ML6123	U	U	8	19	450	181	395
ML6124	U	P	8	19	590	225	590
ML6125	S1	S1	8	19	665	238	535
ML6126	S1	S1	8	18,5	505	210	300
ML6127	U	S1	8	19	264	88	355
ML6128	S1	S1	8	19	523	200	600
ML6129	U	U	8	19	488	195	510
ML6130	P	U	8	19	522	210	490
ML6131	U	U	8	18,5	378	146	300
ML6132	S1	S1	8	19	441	166	530
ML6133	S1	S1	8	19	337,5	120	365
ML6134	S1	S3	8	18,5	503,5	187	450
ML6135	S1	S3	8	18,5	473,5	162	535
ML6136	U	C1	8	18,5	285	90	410
ML6137	U	U	8	18,5	393	150	170
ML6138	U	U	8	18,5	669	186	200
ML6140	S1	U	8	18,5	406	160	335
ML6141	S1	S1	8	18,5	362	112	260
ML6142	U	C1	8	18,5	278	70	470
ML6143	U	U	8	18,5	547	222	535
ML6144	S1	C1	8	18,5	587,5	167,5	590

DIMENSION CHART

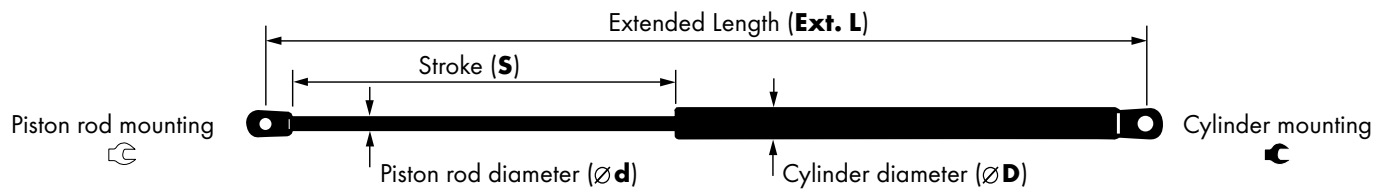

Monroe®	C	⊕	$\varnothing d$	$\varnothing D$	Ext. L	S	F1
ML6145	S1	S3	8	18,5	314	92	485
ML6146	S1	S1	6	15	375	118	180
ML6147	S1	S1	8	18,5	225	60	560
ML6148	S1	S1	8	18,5	274	95	320
ML6149	G	G	10	22	250	72	1180
ML6150	U	U	8	18,5	402,5	160	150
ML6151	S1	C1	8	18,5	517,5	191	295
ML6152	S1	P	8	18,5	361,5	121	540
ML6153	7b	44	8	19	515	210	600
ML6154	9	43	8	16	300	113	400
ML6155	7b	44	8	19	536	225	540
ML6156	13	44	8	19	740,5	280	210
ML6157	7b	44	8	19	500	195	560
ML6158	7b	44	8	19	281,5	77,5	590
ML6159	9	43	8	19	466,5	172	455
ML6160	7b	44	8	19	281,5	77,5	610
ML6161	7b	44	8	19	376	150	120
ML6162	7b	44	8	19	652	240	610
ML6163	7b	44	8	19	298	106	680
ML6164	7b	44	8	19	509,5	204	350
ML6165	7b	44	8	19	687	208	555
ML6166	7b	44	8	19	600	239	385
ML6167	7b	44	8	19	537	180	670
ML6168	13	44	8	19	703	282	530
ML6169	7b	13	8	19	452	170	660
ML6170	7b	13	8	19	370	131	480
ML6171	7b	13	8	19	486	185	500
ML6172	7b	13	8	19	520	198	540
ML6173	9	9	8	19	512	200	470
ML6176	7b	13	8	19	495	183	460
ML6177	7b	44	8	19	294	88	510
ML6178	7b	44	8	19	477	176	650
ML6179	13	25	10	22	482	155	700
ML6180	9	43	8	19	469	186	430
ML6181	28	9	8	19	477	191	100
ML6183	9	13	8	19	487	190	645
ML6184	9	43	8	19	416	158	395
ML6185	13	44	8	19	734	322	320
ML6186	7b	13	8	19	367	144	420
ML6187	7b	44	8	19	453	185	460
ML6188	7b	25	10	22	490	155	910
ML6189	7b	44	8	19	362,5	117	470
ML6190	S1	S3	8	18,5	500	204	420
ML6191	S1	S3	8	18,5	399	160	250
ML6192	U	C1	8	18,5	500	184	440
ML6193	U	C1	8	18,5	329	118	380
ML6194	U	C1	8	18,5	580	179	550
ML6195	U	U	10	22	656	186	880
ML6196	S1	S3	8	18,5	472	200	400
ML6197	S1	S3	8	18,5	422	160	365
ML6198	S1	S3	8	18,5	588	210	360
ML6199	S1	S3	8	18,5	579	248	330
ML6200	S1	S3	8	18,5	471	200	400
ML6201	U	K	10	22	796,5	246,5	720
ML6202	U	C1	8	18,5	554	239	550
ML6203	U	C1	8	18,5	475	150	610
ML6204	S1	S3	8	18,5	348	113	375
ML6205	U	C1	8	18,5	450	117	400
ML6206	U	C1	8	18,5	455	160	570
ML6207	U	C1	8	18,5	630	186	480
ML6209	U	U	10	22	655	195/260	770
ML6210	U	P	8	18,5	527	218	390
ML6211	S1	S3	8	18,5	648	270	260
ML6213	U	C1	8	18,5	550	173	715

Monroe®	C	⊕	$\varnothing d$	$\varnothing D$	Ext. L	S	F1
ML6214	S1	S3	8	18,5	470	165	510
ML6215	S1	S3	8	18,5	420	135	570
ML6216	S1	K	10	22	542	175	740
ML6217	U	C1	8	18,5	552	216	295
ML6218	U	C1	8	18,5	600	195	580
ML6219	U	C1	8	18,5	510	205	270
ML6220	S1	C1	8	18,5	519	185	530
ML6221	P	C1	8	18,5	779	360	285
ML6222	U	C1	8	18,5	295	95/108	380
ML6223	U	C1	8	18,5	561	215	445
ML6224	O	O	8	18,5	565	165	600
ML6225	S1	S3	8	18,5	388	151	480
ML6226	U	C1	8	18,5	500	184	530
ML6227	U	U	8	18,5	371	135	530
ML6228	U	C1	8	18,5	334	117	370
ML6229	S1	S3	8	18,5	486	189	363
ML6230	U	P	8	18,5	498	207	550
ML6231	U	U	8	18,5	686	295	700
ML6232	U	C1	8	18,5	504	215	355
ML6233	U	C1	8	18,5	535	194	455
ML6234	U	K	10	22	640	240	740
ML6235	U	C1	8	18,5	487,5	199	320
ML6236	U	C1	8	18,5	454	185	330
ML6237	S1	S3	8	18,5	440	150	775
ML6238	S1	S3	8	18,5	440	150	705
ML6239	U	C1	8	18,5	485	165	660
ML6240	U	C1	8	18,5	507	175	435
ML6241	S1	S3	8	18,5	632,5	216	550
ML6242	S1	S3	8	18,5	301	104	650
ML6243	U	C1	8	18,5	470	192	245
ML6244	U	K	10	22	391,5	158	880
ML6245	U	C1	8	18,5	362,5	117	390
ML6246	U	C1	8	18,5	550	235	260
ML6247	U	C1	8	18,5	489	151	110
ML6248	S1	S1	6	15	270	102	130
ML6249	S1	S1	10	22	287	107	700
ML6250	S1	S3	8	18,5	440	150	445
ML6251	Y5	X3	8	18,5	319	100	430
ML6253	S1	S3	8	18,5	288	94	260
ML6254	P	C1	8	18,5	730	315	210
ML6255	U	C1	8	18,5	365	139	360
ML6269	U	C1	8	18,5	402	160	390
ML6272	U	S2	8	18,5	305	105	412
ML6273	U	U	8	18,5	600	250	340
ML6276	U	13	8	18,5	558	216	470
ML6277	U	C1	8	18,5	554	200	670
ML6278	U	U	8	18,5	600	250	430
ML6279	U	U	8	18,5	450	175	430
ML6280	U	U	8	18,5	320	105	470
ML6281	S1	S3	8	18,5	369	110	210
ML6283	U	U	8	18,5	502	200	250
ML6284	P	C1	8	18,5	746	291	200
ML6285	S2	S2	10	22	495	145	830
ML6286	S1	S3	8	18,5	368	138	380
ML6287	U	K	10	22	743	237	670
ML6288	U	C1	8	18,5	660	276	500
ML6289	U	C1	8	18,5	499	206	540
ML6290	U	K	8	18,5	556,5	224	450
ML6291	U	C1	8	18,5	543,5	217	460
ML6292	S1	S3	8	18,5	234	60	600
ML6294	P	C1	8	18,5	647	259	275
ML6295	S1	P	8	18,5	605	240	325
ML6296	S1	S3	8	18,5	611	282	480
ML6297	U	U	10	22	650	260	690

DIMENSION CHART

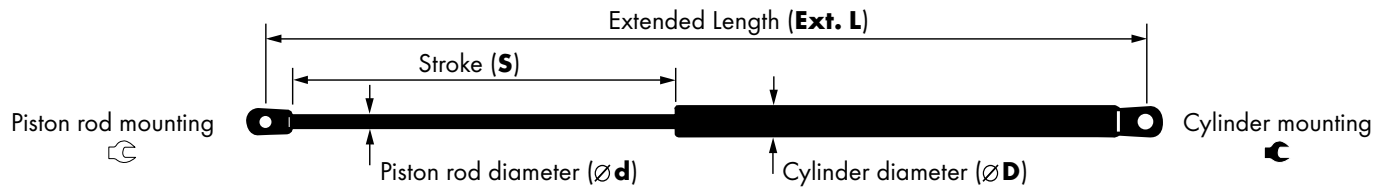

Monroe®	C	☞	Ød	ØD	Ext. L	S	F1
ML6298	U	U	10	22	650	260	745
ML6299	U	U	10	22	759	256	670
ML6300	U	U	10	22	739	202	700
ML6301	U	U	10	22	739	202	850
ML6302	S1	S3	6	15	442	162	160
ML6303	U	C1	8	18,5	565	210/250	360
ML6304	U	U	8	18,5	450	175	380
ML6305	U	C1	8	18,5	684	209	505
ML6306	U	P	10	22	555	202	585
ML6307	P	S3	8	18,5	455	152	200
ML6308	S1	S1	10	22	506	161	720
ML6309	U	C1	8	18,5	810	350	280
ML6310	U	13	8	18,5	610	234	300
ML6311	U	13	8	18,5	588	234	300
ML6312	P	13	8	18,5	568	254	355
ML6313	P	13	8	18,5	532	217	355
ML6314	S1	S3	8	18,5	495	202	475
ML6315	S1	S3	8	18,5	533	195	460
ML6316	P	P	8	18,5	526	207	555
ML6317	U	C1	8	18,5	380	110/120	310
ML6318	P	P	8	18,5	512	212	475
ML6319	U	C1	8	18,5	556	235	240
ML6320	U	C1	8	18,5	483	175/197	440
ML6321	U	P	8	18,5	589	170	540
ML6322	U	C1	8	18,5	540	182	420
ML6323	S1	S3	8	18,5	736	326	315
ML6324	T1	T1	10	22	436	160	363
ML6325	T1	T1	10	22	455	180	300
ML6326	U	C1	8	18,5	346,5	60	400
ML6327	U	C1	8	18,5	548	193	520
ML6328	U	C1	8	18,5	525	220	150
ML6329	S1	S3	8	18,5	445	180	220
ML6330	U	15	8	18,5	560	190	590
ML6331	U	U	10	22	520	180	660
ML6332	U	U	8	18,5	585,5	245	460
ML6333	U	M6	8	18,5	240	85	410
ML6335	S1	S3	8	18,5	439	177	100
ML6336	S1	S3	8	18,5	472,5	176	400
ML6337	S2	15	8	18,5	585	235	500
ML6338	S2	16	8	18,5	585	235	500
ML6339	S1	S3	8	18,5	512	200/225	310
ML6340	S1	S3	8	18,5	516	187	560
ML6341	U	C1	8	18,5	500	180	440
ML6342	P	C1	8	18,5	662	280	350
ML6343	P	C1	8	18,5	681	280	320
ML6344	U	C1	8	18,5	451	162	480
ML6345	T1	T1	8	18,5	632	232	280
ML6346	S1	C1	8	18,5	462	142	650
ML6347	S1	S3	8	18,5	365	107	450
ML6348	S1	S3	8	18,5	520	205	300
ML6349	U	C1	8	18,5	382	136	270
ML6350	S1	S3	8	18,5	367	105	280
ML6351	S1	S3	8	18,5	403	157	120
ML6352	S1	S3	8	18,5	535	210	380
ML6353	S1	S3	8	18,5	488	190	190
ML6354	U	U	10	22	657	200	540
ML6355	U	C1	8	18,5	363	130	150
ML6356	U	U	10	22	697	200	650
ML6357	P	C1	8	18,5	584	194	600
ML6358	P	C1	8	18,5	600	240	425
ML6359	S1	S3	8	18,5	437	157	525
ML6360	S1	S3	8	18,5	377	130	740
ML6361	P	P	8	18,5	610	252	275
ML6362	P	P	8	18,5	602	241	270

Monroe®	C	☞	Ød	ØD	Ext. L	S	F1
ML6363	S1	P	8	18,5	530	218	425
ML6364	P	C1	8	18,5	615	162/230	265
ML6365	P	C1	8	18,5	724	286	340
ML6366	P	C1	8	18,5	456	141	175
ML6367	U	P	8	18,5	476	176	530
ML6368	P	C1	8	18,5	693	304	145

EXTENSION FORCE WITH EXTENDED PISTON ROD

F1

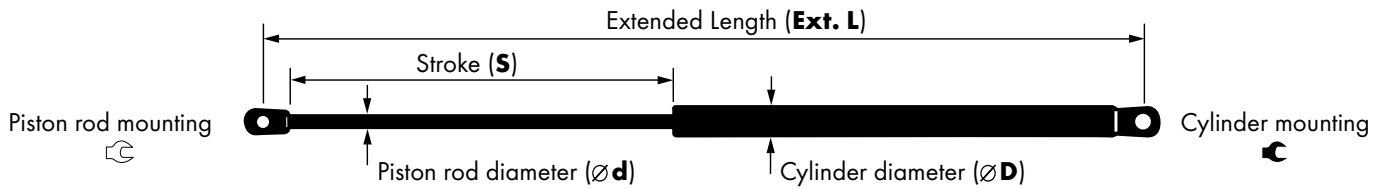

F1	Monroe®	↺	↻	Ød	ØD	Ext. L	S
45	ML5179	S1	S1	6	15	305,5	121
90	ML6083	S1	S3	8	18,5	445	176
100	ML5546	R	R	6	15	185	55
100	ML5629	R	R	6	15	225	80
100	ML5496	Y1	D	8	18,5	226	63
100	ML5823	S1	S1	6	15	362	138
100	ML5297	U	U	8	18,5	435	160
100	ML6335	S1	S3	8	18,5	439	177
100	ML5153	S1	S1	8	18,5	460	169
100	ML6181	28	9	8	19	477	191
100	ML6085	11	11	8	18,5	587	235
105	ML5733	S1	S1	6	15	435	180
110	ML6105	S1	S1	6	15	445	175
110	ML6247	U	C1	8	18,5	489	151
110	ML5548	S1	S1	6	15	530	213
110	ML5959	S1	S1	8	18,5	589	240
113	ML5492	Y1	D	8	18,5	465	169
115	ML5910	U	S1	8	18,5	355	135
120	ML6161	7b	44	8	19	376	150
120	ML6351	S1	S3	8	18,5	403	157
125	ML5547	S1	S1	6	15	502	200
125	ML5961	S1	S3	8	18,5	526,5	208
125	ML5357	U	U	8	18,5	538	190
130	ML6248	S1	S1	6	15	270	102
130	ML5640	T1	T1	6	15	305	109
130	ML5230	S1	S1	6	15	447	170
130	ML5812	U	U	8	18,5	520	208
135	ML5552	S1	S1	6	15	365	135
135	ML5700	U	U	8	18,5	480	173
135	ML5825	S1	S1	8	18,5	500	230
135	ML5493	S1	S1	8	18,5	558	200
140	ML5762	P	U	8	18,5	385	150
140	ML5340	U	U	8	18,5	525	210
140	ML5956	S1	S3	8	18,5	563	235
140	ML5726	U	U	8	18,5	730	316
145	ML6368	P	C1	8	18,5	693	304
150	ML5356	U	U	8	18,5	352	110
150	ML6355	U	C1	8	18,5	363	130
150	ML6150	U	U	8	18,5	402,5	160
150	ML5676	U	U	8	18,5	436	175
150	ML6043	U	U	8	18,5	499	145
150	ML6328	U	C1	8	18,5	525	220
150	ML6060	S1	S1	8	18,5	584	250
160	ML6035	P	P	8	18,5	386,5	145
160	ML6302	S1	S3	6	15	442	162
160	ML5116	U	U	8	18,5	450	175
160	ML5568	S1	S1	8	18,5	464	166
160	ML6008	S1	S1	8	18,5	516	184
160	ML5026	U	U	8	18,5	528	224
160	ML5055	Y1	X1	8	18,5	549,5	229,5
160	ML5598	S1	S1	8	18,5	600	250
160	ML5139	S1	S1	8	18,5	602	250
160	ML5565	P	S1	8	18,5	715	303
165	ML5810	U	U	8	18,5	238	62
165	ML5822	S1	S1	8	18,5	580	245
170	ML6137	U	U	8	18,5	393	150
170	ML6082	S1	S1	8	18,5	435	175
170	ML5739	U	P	8	18,5	485	200
170	ML5447	T1	T1	8	18,5	540	130
170	ML5551	S1	S1	6	15	547	190
175	ML6366	P	C1	8	18,5	456	141
180	ML5030	Y1	X1	8	18,5	256	86
180	ML6090	I	H	6	15	359	150
180	ML5365	U	U	8	18,5	365	135

F1	Monroe®	↺	↻	Ød	ØD	Ext. L	S
180	ML6146	S1	S1	6	15	375	118
180	ML5387	U	U	8	18,5	395	148
180	ML5623	S1	S1	8	18,5	398	120
180	ML5461	S1	S1	8	18,5	506	205
180	ML5009	Y1	X1	8	18,5	600	255
180	ML5938	S1	U	8	18,5	672	240
180	ML5268	U	U	8	18,5	685	285
180	ML5737	P	U	8	18,5	720	300
180	ML6049	U	U	8	18,5	721,5	313
185	ML6009	S1	S1	8	18,5	456	182
190	ML5017	U	X2	8	18,5	362	135
190	ML6353	S1	S3	8	18,5	488	190
190	ML5287	S1	U	8	18,5	500	200
190	ML5091	E4	T1	8	18,5	613,8	248
190	ML5092	E4	T1	8	18,5	613,8	248
190	ML5267	S1	S1	8	18,5	648	265
200	ML5998	C	U	8	18,5	380	127
200	ML6307	P	S3	8	18,5	455	152
200	ML5650	P	U	8	18,5	484	190
200	ML5509	T1	T1	8	18,5	534	217
200	ML5954	U	U	8	18,5	543	220
200	ML5788	T1	T1	8	18,5	554	185
200	ML5973	S1	S1	8	18,5	565	200
200	ML5034	Y1	X1	8	18,5	585	250
200	ML5010	Y1	X1	8	18,5	600	255
200	ML5567	S1	S1	8	18,5	635	225
200	ML6138	U	U	8	18,5	669	186
200	ML5470	S1	S1	8	18,5	685	265
200	ML5021	U	U	8	18,5	700	251
200	ML6284	P	C1	8	18,5	746	291
200	ML5638	U	U	8	18,5	765	324
210	ML6281	S1	S3	8	18,5	369	110
210	ML5081	U	C1	8	18,5	569	242
210	ML5608	N	N	8	18,5	675	279
210	ML6254	P	C1	8	18,5	730	315
210	ML6156	13	44	8	19	740,5	280
215	ML5399	U	U	8	18,5	570	230
220	ML6065	U	C1	8	18,5	314,5	116
220	ML6329	S1	S3	8	18,5	445	180
220	ML5028	U	U	8	18,5	460	170
220	ML5572	Y1	U	8	18,5	500	190
220	ML5036	Y1	X1	8	18,5	518	209
220	ML5099	U	U	8	18,5	528	224
220	ML5457	U	U	8	18,5	546	225
220	ML5659	S1	S1	8	18,5	553	225
220	ML6111	S1	C1	8	18,5	694	294
220	ML5022	Y1	X1	8	18,5	696	278
225	ML5306	U	U	8	18,5	500	196
225	ML5556	Y1	X1	6	15	547	214
230	ML5980	U	U	8	18,5	285	104
230	ML5472	S1	S1	8	18,5	395	150
230	ML5870	S1	S1	6	15	400	160
230	ML5587	S1	S1	8	18,5	459	172
230	ML5600	Y1	D	8	18,5	500	200
230	ML5056	Y1	X1	8	18,5	520	213
230	ML5597	U	X1	8	18,5	547	230
230	ML5006	Y2	X2	8	18,5	550	212
230	ML5620	U	U	8	18,5	580	205
235	ML5409	U	U	8	18,5	765	325
240	ML5813	S1	S1	6	15	297	112,5
240	ML5366	U	U	8	18,5	365	135
240	ML5939	U	U	8	18,5	427	165
240	ML5350	U	U	8	18,5	525	210
240	ML5636	U	U	8	18,5	525	210

EXTENSION FORCE WITH EXTENDED PISTON ROD

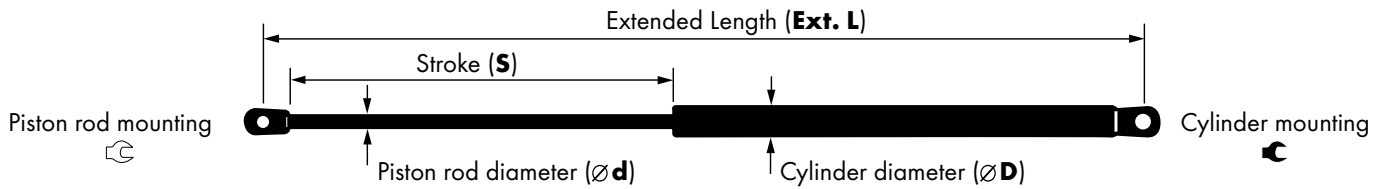
F1

F1	Monroe®	↻	↻	Ød	ØD	Ext. L	S
240	ML5016	Y1	X2	8	18,5	549	229,5
240	ML6319	U	C1	8	18,5	556	235
240	ML5827	U	U	8	18,5	603	255
240	ML5919	Y1	D	8	18,5	615	243
245	ML5992	P	U	8	18,5	436	154
245	ML6243	U	C1	8	18,5	470	192
245	ML5821	S1	U	8	18,5	500	203
245	ML5276	U	U	8	18,5	529	215
245	ML5807	U	U	8	18,5	609,5	251,5
250	ML5791	S1	U	8	18,5	201	52
250	ML5536	U	Q	8	18,5	288	95
250	ML5861	S1	S1	8	18,5	296	95
250	ML6191	S1	S3	8	18,5	399	160
250	ML5183	U	U	8	18,5	445	172
250	ML5180	U	U	8	18,5	490	190
250	ML5995	U	P	8	18,5	494	194
250	ML6283	U	U	8	18,5	502	200
250	ML5327	U	U	8	18,5	540	220
250	ML5607	S1	S1	8	18,5	544	224
250	ML5265	U	U	8	18,5	585	235
250	ML5133	U	U	8	18,5	600	250
250	ML5697	U	U	8	18,5	604	253
250	ML5976	N	N	8	18,5	673	276
250	ML5735	P	U	8	18,5	730	320
255	ML6114	S1	H1	6	15	310	122
260	ML6253	S1	S3	8	18,5	288	94
260	ML6141	S1	S1	8	18,5	362	112
260	ML6061	U	U	8	18,5	404	157
260	ML5025	U	U	8	18,5	450	175
260	ML5298	U	U	8	18,5	450	175
260	ML6246	U	C1	8	18,5	550	235
260	ML5143	U	U	8	18,5	574	235
260	ML6069	U	P	8	18,5	585	246
260	ML6211	S1	S3	8	18,5	648	270
260	ML5309	U	U	8	18,5	675	285
260	ML6032	U	I3	10	22	874	404
265	ML5926	U	C1	8	18,5	408	152
265	ML6364	P	C1	8	18,5	615	162/230
265	ML6072	U	U	8	18,5	664	275
265	ML5648	P	U	8	18,5	728	310
270	ML6063	S1	P	6	15	334	130
270	ML6349	U	C1	8	18,5	382	136
270	ML5846	U	D	8	18,5	405	164
270	ML5097	U	U	8	18,5	460	170
270	ML5098	P	P	8	18,5	496	188
270	ML5574	U	D	8	18,5	500	200
270	ML6219	U	C1	8	18,5	510	205
270	ML5564	U	P	8	18,5	577	225
270	ML6362	P	P	8	18,5	602	241
270	ML5393	U	U	8	18,5	678	270
270	ML5561	U	U	8	18,5	687	295
270	ML5337	U	U	8	18,5	691,5	285
275	ML5463	S1	S1	8	18,5	577	226
275	ML6361	P	P	8	18,5	610	252
275	ML6294	P	C1	8	18,5	647	259
280	ML5018	Y1	X1	8	18,5	256	86
280	ML5946	U	C	8	18,5	293	104
280	ML5670	S1	S1	8	18,5	366	117
280	ML6350	S1	S3	8	18,5	367	105
280	ML5924	U	C1	8	18,5	375	144
280	ML5484	S1	S1	8	18,5	400	150
280	ML5422	10	10	6	15	410	166
280	ML5035	U	U	8	18,5	450	175
280	ML5038	U	U	8	18,5	500	200

F1	Monroe®	↻	↻	Ød	ØD	Ext. L	S
280	ML5195	S1	U	8	18,5	500	200
280	ML5072	U	U	8	18,5	502	200
280	ML5101	S1	S1	8	18,5	502	199
280	ML5560	U	I3	8	18,5	525	200
280	ML5780	T1	T1	8	18,5	550	235
280	ML5577	U	I3	8	18,5	563	200
280	ML5040	U	U	8	18,5	569	220
280	ML5014	U	U	8	18,5	584	234
280	ML5134	U	U	8	18,5	585	222
280	ML5013	U	U	8	18,5	595	235
280	ML6345	T1	T1	8	18,5	632	232
280	ML5266	U	C1	8	18,5	722	306
280	ML5102	Y1	V	8	18,5	788	342
280	ML6309	U	C1	8	18,5	810	350
285	ML5292	U	U	8	18,5	550	220
285	ML6221	P	C1	8	18,5	779	360
290	ML5323	U	U	8	18,5	285	95
290	ML5095	U	U	8	18,5	324	115
290	ML5906	I	H	6	15	365,5	150
290	ML5651	P	U	8	18,5	544	218
290	ML6040	U	U	8	18,5	549	219
290	ML5850	S1	P	8	18,5	559	230
290	ML5705	S1	U	8	18,5	565	240
290	ML5066	U	U	8	18,5	584	234
290	ML5020	U	U	8	18,5	600	230
290	ML5450	U	U	8	18,5	635	259
290	ML5269	P	U	8	18,5	715	306
290	ML5790	P	S1	8	18,5	740	310
295	ML6028	S1	I2	8	18,5	397	158
295	ML6151	S1	C1	8	18,5	517,5	191
295	ML6217	U	C1	8	18,5	552	216
300	ML5404	U	U	8	18,5	240	74
300	ML6101	S1	S1	6	15	285	100
300	ML6131	U	U	8	18,5	378	146
300	ML5624	P	T1	8	18,5	392	150
300	ML5392	S1	S1	8	18,5	400	149
300	ML5649	U	U	8	18,5	405	160
300	ML5382	U	S1	8	18,5	440	155
300	ML5660	P	U	8	18,5	441	175
300	ML5079	U	U	8	18,5	445	180
300	ML5814	U	U	8	18,5	447	175
300	ML5003	U	U	8	18,5	450	180
300	ML6325	T1	T1	10	22	455	180
300	ML5270	U	U	8	18,5	460	160
300	ML5339	S1	U	8	18,5	480	180
300	ML6126	S1	S1	8	18,5	505	210
300	ML5645	Y1	U	8	18,5	512	200
300	ML6348	S1	S3	8	18,5	520	205
300	ML5271	U	U	8	18,5	522	210
300	ML5041	U	U	8	18,5	542	210
300	ML5312	U	U	8	18,5	545	230
300	ML6311	U	I3	8	18,5	588	234
300	ML5148	U	U	8	18,5	600	230
300	ML6310	U	I3	8	18,5	610	234
300	ML5820	U	U	8	18,5	613	260
300	ML5465	S1	S1	8	18,5	614	229
300	ML6003	U	P	8	18,5	644	265
300	ML5798	U	U	8	18,5	674	293
300	ML5738	P	U	8	18,5	735	321
300	ML5368	S1	S1	8	18,5	750	315
305	ML6015	U	U	8	18,5	232,5	65
305	ML5687	U	U	8	18,5	555	228
310	ML5471	S1	S1	8	18,5	286	100
310	ML5489	S1	S1	8	18,5	364	132

EXTENSION FORCE

EXTENSION FORCE WITH EXTENDED PISTON ROD

F1

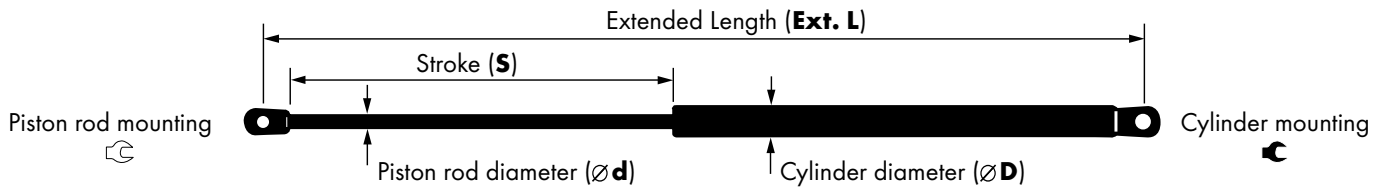

F1	Monroe®	↻	↻	Ø d	Ø D	Ext. L	S
310	ML6317	U	C1	8	18,5	380	110/120
310	ML6081	S1	S1	8	18,5	404,5	160
310	ML5275	U	U	8	18,5	405	160
310	ML5316	U	U	8	18,5	408	150
310	ML5136	U	U	8	18,5	448	180
310	ML5491	S1	U	8	18,5	500	200
310	ML6339	S1	S3	8	18,5	512	200/225
310	ML5347	U	U	8	18,5	525	205
310	ML5720	U	U	8	18,5	543	220
310	ML5869	U	P	8	18,5	569	240
310	ML5147	U	U	8	18,5	574	235
310	ML5842	S2	15	8	18,5	585	235
310	ML5843	S2	16	8	18,5	585	235
310	ML5042	Y1	X1	8	18,5	600	255
310	ML5345	U	U	8	18,5	650	270
310	ML5603	Y1	D	8	18,5	650	275
310	ML5605	S1	D	8	18,5	650	275
310	ML5679	L	L	8	18,5	722	306
315	ML5063	U	U	8	18,5	284	100
315	ML5730	U	U	8	18,5	565	215
315	ML6074	U	Q	8	18,5	663,5	271
315	ML6079	P	U	8	18,5	728	310
315	ML6323	S1	S3	8	18,5	736	326
320	ML6148	S1	S1	8	18,5	274	95
320	ML5163	S1	S1	8	18,5	350	100
320	ML5421	10	10	6	15	367	145
320	ML5658	S1	S1	8	18,5	369	110
320	ML5694	S1	S1	8	18,5	370	110
320	ML6046	U	U	8	18,5	431	173
320	ML5655	S1	U	8	18,5	456	165
320	ML6100	U	U	8	18,5	457	167
320	ML5420	Y1	D	8	18,5	465	187
320	ML5159	S1	S1	8	18,5	485	190
320	ML6235	U	C1	8	18,5	487,5	199
320	ML5284	S1	U	8	18,5	500	200
320	ML5361	U	U	8	18,5	510	200
320	ML5140	U	U	8	18,5	526	206
320	ML5242	U	U	8	18,5	543,5	206
320	ML5243	U	U	8	18,5	549	232
320	ML5464	S1	S1	8	18,5	577	226
320	ML5606	Y1	D	8	18,5	579	235
320	ML5255	U	U	8	18,5	600	250
320	ML5184	S1	P	8	18,5	600,5	223
320	ML6343	P	C1	8	18,5	681	280
320	ML5407	U	U	8	18,5	700	257
320	ML6185	13	44	8	19	734	322
325	ML6031	S1	10	6	15	242	74
325	ML5849	U	U	8	18,5	526	220
325	ML6041	T1	T1	10	22	600	220
325	ML6295	S1	P	8	18,5	605	240
325	ML5037	U	P	8	18,5	700	300
325	ML5057	P	S1	8	18,5	700	300
325	ML5386	U	U	8	18,5	722	315
330	ML5611	Y1	D	8	18,5	245	76
330	ML5562	S1	S1	8	18,5	313	112
330	ML5804	U	U	8	18,5	314,5	116
330	ML5689	S1	P	8	18,5	400	160
330	ML6236	U	C1	8	18,5	454	185
330	ML5164	U	U	8	18,5	472	180
330	ML5406	U	U	8	18,5	498	197
330	ML5731	S1	P	8	18,5	505	211
330	ML6024	P	13	8	18,5	533	216
330	ML5588	S1	S1	8	18,5	559	220
330	ML5819	U	U	8	18,5	568	233

F1	Monroe®	↻	↻	Ø d	Ø D	Ext. L	S
330	ML6025	P	13	8	18,5	570	254
330	ML5342	U	U	8	18,5	575	235
330	ML6199	S1	S3	8	18,5	579	248
330	ML5325	U	U	8	18,5	600	244
330	ML5023	U	U	8	18,5	614	230
330	ML5282	U	U	8	18,5	630	269
330	ML5799	U	U	8	18,5	674	293
335	ML6140	S1	U	8	18,5	406	160
335	ML5840	I	H	6	15	465	190
335	ML5708	U	U	8	18,5	480	195
335	ML5873	U	P	8	18,5	514	180
340	ML5639	Y1	D	8	18,5	254	85
340	ML5619	N	N	8	18,5	330	116
340	ML5999	U	U	6	15	346	136
340	ML5241	U	U	8	18,5	412	155
340	ML5024	U	C1	8	18,5	450	175
340	ML5114	U	U	8	18,5	450	175
340	ML5805	P	U	8	18,5	479	179
340	ML5909	I	U	8	18,5	496,5	195
340	ML5767	S1	U	8	18,5	500	195
340	ML5146	S1	S1	8	18,5	510	210
340	ML5398	U	U	8	18,5	580	245
340	ML6273	U	U	8	18,5	600	250
340	ML5534	S1	U	8	18,5	605	247
340	ML5631	T1	T1	8	18,5	677	274
340	ML6365	P	C1	8	18,5	724	286
340	ML5741	U	U	8	18,5	765	335
345	ML5499	Y1	D	8	18,5	700	295
350	ML6066	S1	S1	6	15	195,5	60
350	ML5596	Y4	X1	6	15	254	95
350	ML5922	S1	S3	8	18,5	255	78
350	ML6020	S1	10	6	15	289	113
350	ML5789	U	U	8	18,5	345	122
350	ML5696	P	U	8	18,5	355	120
350	ML5563	S1	S1	8	18,5	374	140
350	ML5714	U	P	8	18,5	386,5	150
350	ML5695	S1	U	8	18,5	425	165
350	ML5775	S1	S1	8	18,5	437	173
350	ML5480	S1	S1	8	18,5	452	177
350	ML5785	S1	S1	8	18,5	460	170
350	ML5867	U	U	8	18,5	460,5	174
350	ML5069	U	U	8	18,5	470	190
350	ML5920	U	U	8	18,5	470	180
350	ML5120	U	C1	8	18,5	475	195
350	ML5049	U	C1	8	18,5	500	212
350	ML5261	S1	U	8	18,5	500	200
350	ML5264	S1	U	8	18,5	500	200
350	ML5390	U	U	8	18,5	508	194
350	ML6164	7b	44	8	19	509,5	204
350	ML5359	U	U	8	18,5	513	215
350	ML5348	U	U	8	18,5	525	205
350	ML5211	U	U	8	18,5	527	210
350	ML5015	Y1	X1	8	18,5	549	229,5
350	ML5077	U	C1	8	18,5	591	240
350	ML5715	U	C1	8	18,5	650	270
350	ML6342	P	C1	8	18,5	662	280
350	ML5768	U	U	8	18,5	721,5	315
355	ML6127	U	S1	8	19	264	88
355	ML5945	P	U	6	15	314	110
355	ML6232	U	C1	8	18,5	504	215
355	ML6313	P	13	8	18,5	532	217
355	ML5031	U	U	8	18,5	549	222
355	ML6312	P	13	8	18,5	568	254
355	ML5149	U	U	8	18,5	611	230

EXTENSION FORCE WITH EXTENDED PISTON ROD

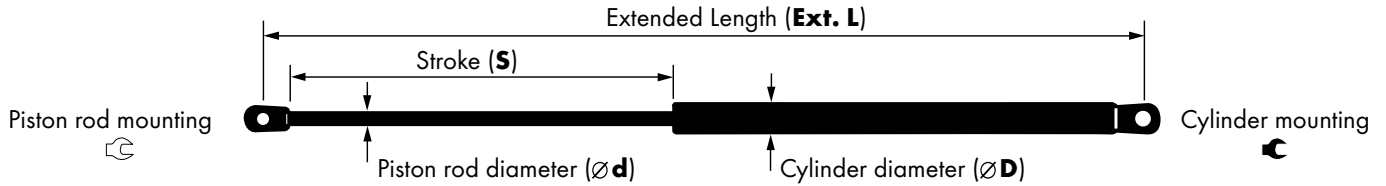
F1

F1	Monroe®	C	C	Ød	ØD	Ext. L	S
355	ML5369	U	U	8	18,5	828	249
360	ML5488	S1	S1	8	18,5	320	100
360	ML6255	U	C1	8	18,5	365	139
360	ML5832	U	P	8	18,5	390	155
360	ML5625	Y1	U	8	18,5	419	165
360	ML5796	S1	U	8	18,5	463	185
360	ML5093	S1	S1	8	18,5	471	191
360	ML5462	S1	S1	8	18,5	477	188
360	ML5907	S1	S3	8	18,5	481	183
360	ML5360	U	U	8	18,5	500	190
360	ML5784	U	U	8	18,5	510	213
360	ML5895	U	U	8	18,5	532,5	190
360	ML5054	U	U	8	18,5	543,5	206
360	ML5171	U	U	8	18,5	557	224
360	ML5144	U	U	8	18,5	565	216
360	ML6303	U	C1	8	18,5	565	210/250
360	ML5396	U	U	8	18,5	568	213
360	ML5191	U	U	8	18,5	585	235
360	ML6198	S1	S3	8	18,5	588	210
360	ML5434	U	U	8	18,5	599	220
360	ML5011	Y1	X1	8	18,5	600	255
360	ML5394	U	U	8	18,5	600	226
360	ML5815	U	U	8	18,5	600	228
360	ML5129	S1	S1	8	18,5	622	240
360	ML5364	U	U	8	18,5	635	248
360	ML5521	T1	Q	8	18,5	665	270
360	ML5589	S1	S1	8	18,5	671,5	270
360	ML5192	U	U	8	18,5	680	270
360	ML5634	T1	T1	8	18,5	680	270
360	ML5758	P	U	8	18,5	726,5	310
363	ML6324	T1	T1	10	22	436	160
363	ML6229	S1	S3	8	18,5	486	189
365	ML5259	U	U	8	18,5	287	99
365	ML6133	S1	S1	8	19	337,5	120
365	ML6197	S1	S3	8	18,5	422	160
365	ML5199	S1	U	8	18,5	500	200
365	ML5890	S1	S1	8	18,5	515	210
370	ML5595	Y5	X3	8	18,5	255	86
370	ML5215	S1	S1	8	18,5	264	82
370	ML6094	S2	S2	8	18,5	299,5	88
370	ML6062	S1	D	8	18,5	305	105
370	ML5411	S1	U	8	18,5	315	105
370	ML5646	Y5	X3	8	18,5	319	100
370	ML6228	U	C1	8	18,5	334	117
370	ML5490	S1	S1	8	18,5	363	132
370	ML5777	U	U	8	18,5	430	170
370	ML5222	S1	U	8	18,5	440	171
370	ML5210	U	U	8	18,5	440,5	158
370	ML5759	T1	T1	8	18,5	483	191
370	ML6036	U	U	8	18,5	495	190
370	ML5370	U	P	8	18,5	510	200
370	ML5068	U	U	8	18,5	515	202
370	ML5864	U	U	8	18,5	519	184
370	ML5208	U	U	8	18,5	552	205
370	ML5285	U	U	8	18,5	595	248
370	ML5448	U	U	10	22	866	350
370	ML5584	S1	U	10	22	870	370
375	ML6204	S1	S3	8	18,5	348	113
375	ML5752	U	U	8	18,5	500	208
375	ML5542	U	U	8	18,5	667	215
375	ML5333	Y1	D	8	18,5	668	280
375	ML5403	U	U	8	18,5	668	215
380	ML5803	S1	S1	8	18,5	240	70
380	ML5522	10	10	8	18,5	242	84

F1	Monroe®	C	C	Ød	ØD	Ext. L	S
380	ML5921	S1	S1	8	18,5	270	82
380	ML5975	S1	S3	8	18,5	288,5	100
380	ML5698	S1	U	8	18,5	291	107
380	ML5301	U	U	8	18,5	295	100
380	ML6222	U	C1	8	18,5	295	95/108
380	ML5766	S1	S1	8	18,5	318	120
380	ML6193	U	C1	8	18,5	329	118
380	ML6286	S1	S3	8	18,5	368	138
380	ML5145	U	C1	8	18,5	431	173
380	ML5599	Y1	X1	6	15	440	142
380	ML6304	U	U	8	18,5	450	175
380	ML5165	U	U	8	18,5	455	164
380	ML5453	U	U	8	18,5	460	180
380	ML5427	S1	U	8	18,5	471	185
380	ML5570	S1	S1	8	18,5	490	187
380	ML5712	P	U	8	18,5	490	200
380	ML5194	S1	U	8	18,5	500	200
380	ML5281	U	U	8	18,5	506	200
380	ML6352	S1	S3	8	18,5	535	210
380	ML5039	Y1	X2	8	18,5	550	229,5
380	ML5609	W	D	8	18,5	580	245
380	ML5235	U	U	8	18,5	596	190
380	ML6096	P	U	8	18,5	690	280
380	ML5829	P	U	8	18,5	730	310
380	ML5678	U	L	10	22	943	417
385	ML5725	S1	S1	8	18,5	451	185
385	ML5672	U	U	8	18,5	540	210
385	ML6166	7b	44	8	19	600	239
390	ML5419	S1	S1	8	18,5	280	95
390	ML6245	U	C1	8	18,5	362,5	117
390	ML5830	U	P	8	18,5	375	140
390	ML5943	S1	S3	8	18,5	376	145
390	ML5111	U	C1	8	18,5	402	160
390	ML6269	U	C1	8	18,5	402	160
390	ML5925	U	C1	8	18,5	408	152
390	ML5936	P	U	8	18,5	410	155
390	ML5977	S1	S1	8	18,5	418,5	155
390	ML5395	U	U	8	18,5	510	208
390	ML5300	U	U	8	18,5	527	202
390	ML6210	U	P	8	18,5	527	218
390	ML5763	T1	T1	8	18,5	540	225
390	ML5573	U	D	8	18,5	640	235
390	ML5162	S1	S1	8	18,5	666,5	275
390	ML5508	T1	T1	8	18,5	680	270
395	ML6120	U	U	8	18,5	280	95
395	ML6107	S1	S3	8	19	290	102
395	ML6184	9	43	8	19	416	158
395	ML6123	U	U	8	19	450	181
400	ML5974	T1	T1	6	15	155	40
400	ML5643	S1	S1	6	15	244	90
400	ML6047	S1	S1	8	18,5	283	87
400	ML6154	9	43	8	16	300	113
400	ML5729	U	U	8	18,5	310	110
400	ML6326	U	C1	8	18,5	346,5	60
400	ML6026	U	13	8	18,5	394	149
400	ML5855	S1	S1	8	18,5	400	139
400	ML5691	S1	U	8	18,5	412	163
400	ML6027	U	13	8	18,5	429	149
400	ML5981	U	U	8	18,5	431	100
400	ML6205	U	C1	8	18,5	450	117
400	ML6200	S1	S3	8	18,5	471	200
400	ML6196	S1	S3	8	18,5	472	200
400	ML6336	S1	S3	8	18,5	472,5	176
400	ML5371	U	U	8	18,5	499	195

EXTENSION FORCE

EXTENSION FORCE WITH EXTENDED PISTON ROD

F1

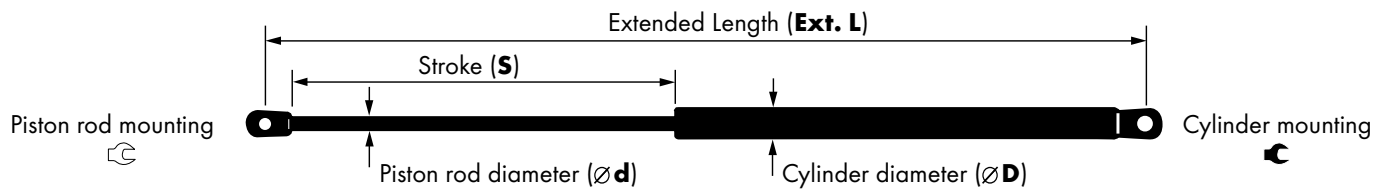

F1	Monroe®	↺	↻	$\text{Ø}d$	$\text{Ø}D$	Ext. L	S
400	ML5115	U	U	8	18,5	500	200
400	ML5196	S1	U	8	18,5	500	200
400	ML5358	U	U	8	18,5	500	171
400	ML5004	U	U	8	18,5	502	200
400	ML5615	U	P	8	18,5	502	195
400	ML5713	U	U	8	18,5	515	215
400	ML5272	U	U	8	18,5	522	210
400	ML5188	U	U	8	18,5	540	214
400	ML5201	U	U	8	18,5	577	226
400	ML6122	P	P	8	19	588	204
400	ML5286	U	U	8	18,5	591	239
400	ML5593	Y1	D	8	18,5	615	260
400	ML5432	S1	S1	8	18,5	624	260
400	ML5435	S1	S1	8	18,5	656	260
400	ML5494	Y1	D	8	18,5	700	295
400	ML6039	T1	T1	10	22	742	277
405	ML5665	U	U	8	18,5	585,5	245
410	ML6333	U	M6	8	18,5	240	85
410	ML6136	U	C1	8	18,5	285	90
410	ML6004	S1	S1	8	18,5	292	88
410	ML5182	S1	S1	8	18,5	300	100
410	ML5928	S1	S1	8	18,5	305	96
410	ML6006	U	U	8	18,5	319,5	120
410	ML5444	10	10	8	18,5	365	145
410	ML6084	T1	T1	8	18,5	414	160
410	ML6086	U	U	8	18,5	439,5	155
410	ML5749	U	P	8	18,5	530	210
410	ML5161	U	U	8	18,5	534	216
410	ML5809	S1	S1	8	18,5	536	204
410	ML5244	U	U	8	18,5	549	232
410	ML5209	U	U	8	18,5	552	200
410	ML5541	S1	S1	8	18,5	568	215
410	ML5317	U	U	8	18,5	590	215
410	ML5385	U	X1	10	22	885	380
412	ML6272	U	S2	8	18,5	305	105
415	ML5200	U	U	8	18,5	577	226
420	ML5389	S1	S1	8	18,5	215	48
420	ML5566	10	10	8	18,5	254	90
420	ML5481	S1	S1	8	18,5	270	75
420	ML6011	U	U	8	18,5	273	85
420	ML5467	S1	S1	8	18,5	280	80
420	ML5321	U	U	8	18,5	315	100
420	ML6033	U	U	8	18,5	338	119
420	ML6186	7b	13	8	19	367	144
420	ML5151	U	U	8	18,5	445	162
420	ML5779	U	U	8	18,5	445	160
420	ML5087	U	C1	8	18,5	473	172
420	ML5254	U	U	8	18,5	476,5	184
420	ML5703	P	U	8	18,5	480	190
420	ML5776	U	P	8	18,5	495	197
420	ML5197	S1	U	8	18,5	500	205
420	ML6190	S1	S3	8	18,5	500	204
420	ML5078	U	U	8	18,5	507	205
420	ML5005	U	U	8	18,5	509	200
420	ML5436	S1	S1	8	18,5	517	190
420	ML5048	U	U	8	18,5	527	219
420	ML5754	U	P	8	18,5	528	212
420	ML6322	U	C1	8	18,5	540	182
420	ML5862	S1	S1	8	19	548	220
420	ML5400	U	U	8	18,5	570	230
420	ML5664	U	U	8	18,5	585	240
420	ML5237	U	U	8	18,5	596	190
420	ML6089	T1	T1	8	18,5	611	228
420	ML5051	S1	E1	10	22	726	280

F1	Monroe®	↺	↻	$\text{Ø}d$	$\text{Ø}D$	Ext. L	S
425	ML5764	U	U	8	18,5	252	85
425	ML5158	U	U	8	18,5	465	178
425	ML5405	U	U	8	18,5	516	205
425	ML6363	S1	P	8	18,5	530	218
425	ML5474	S1	S1	8	18,5	535	220
425	ML5668	S1	U	8	18,5	545	195
425	ML5172	U	U	8	18,5	557	224
425	ML5206	U	U	8	18,5	599	190
425	ML6358	P	C1	8	18,5	600	240
430	ML5274	U	U	8	18,5	278	90
430	ML6112	U	C	8	18,5	298	94
430	ML5355	U	U	8	18,5	310	95
430	ML6251	Y5	X3	8	18,5	319	100
430	ML6118	U	C1	8	18,5	340	113
430	ML5868	U	P	8	18,5	414	150
430	ML6279	U	U	8	18,5	450	175
430	ML5160	S1	S1	8	18,5	458	176
430	ML6180	9	43	8	19	469	186
430	ML5717	P	U	8	18,5	497	200
430	ML5618	N	N	8	18,5	505	180
430	ML5166	U	C1	8	18,5	536,5	205
430	ML5367	U	U	8	18,5	567,5	183
430	ML6070	U	C1	8	18,5	585	250
430	ML5236	U	U	8	18,5	596	195
430	ML5065	U	U	8	18,5	600	245
430	ML6278	U	U	8	18,5	600	250
430	ML5107	U	U	8	18,5	602	252
430	ML5299	U	U	8	18,5	602	252
435	ML6240	U	C1	8	18,5	507	175
435	ML5296	U	U	8	18,5	520	197
435	ML5701	S1	U	8	18,5	590	176
436	ML5362	U	U	8	18,5	507	208
440	ML5740	S1	U	8	18,5	315	120
440	ML5680	U	U	8	18,5	350	130
440	ML5706	P	U	8	18,5	395	158
440	ML5734	S1	S1	8	18,5	460	180
440	ML5485	S1	U	8	18,5	468	163
440	ML6320	U	C1	8	18,5	483	175/197
440	ML5681	U	U	8	18,5	495	205
440	ML6192	U	C1	8	18,5	500	184
440	ML6341	U	C1	8	18,5	500	180
440	ML5252	U	U	8	18,5	544	210
440	ML5202	U	U	8	18,5	566	230
440	ML5482	S1	S1	8	18,5	575	230
440	ML5207	U	U	8	18,5	600	190
440	ML5795	U	U	8	18,5	628	272
440	ML5458	U	U	8	18,5	631	230
440	ML5315	U	U	8	18,5	675	275
445	ML6250	S1	S3	8	18,5	440	150
445	ML5917	S1	S1	8	18,5	493	195
445	ML5410	S1	S1	8	18,5	515	200
445	ML6223	U	C1	8	18,5	561	215
450	ML5978	S1	S1	8	18,5	201	60
450	ML5617	N	N	8	18,5	268	83,5
450	ML5663	U	U	8	18,5	283	101,5
450	ML6098	S1	U	8	18,5	344,5	88,5
450	ML6108	S1	S1	8	19	345	128
450	ML6347	S1	S3	8	18,5	365	107
450	ML5669	U	U	8	18,5	424,5	165
450	ML5131	U	C1	8	18,5	440	160
450	ML5307	U	U	8	18,5	485	189
450	ML5181	S1	U	8	18,5	500	200
450	ML5923	U	U	8	18,5	502	205
450	ML6134	S1	S3	8	18,5	503,5	187

EXTENSION FORCE WITH EXTENDED PISTON ROD

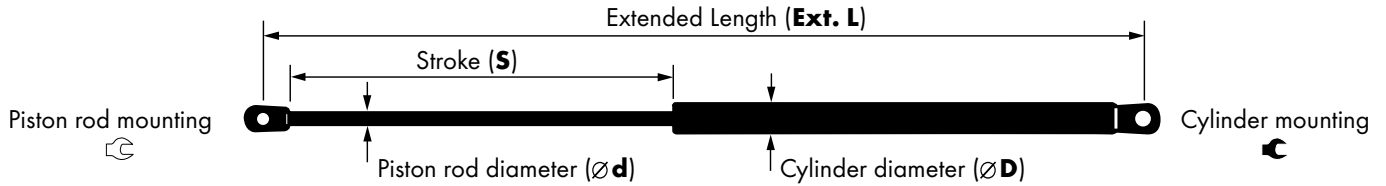
F1

F1	Monroe®	↶	↷	Ød	ØD	Ext. L	S
450	ML5044	U	U	8	18,5	527	219
450	ML5061	U	C1	8	18,5	527	210
450	ML5169	U	U	8	18,5	527	206
450	ML5157	U	U	10	22	540	200
450	ML5213	S1	S1	8	18,5	540	200
450	ML5692	U	U	8	18,5	545	210
450	ML5353	U	U	8	18,5	555	220
450	ML6290	U	K	8	18,5	556,5	224
450	ML5318	U	U	8	18,5	590	215
450	ML5262	U	U	8	18,5	595	250
450	ML5544	U	S1	8	18,5	596	210
450	ML5067	Y1	X1	8	18,5	600	255
450	ML5320	U	U	8	18,5	600	225
450	ML5418	U	U	8	18,5	645,5	275
455	ML5891	S1	S1	8	18,5	383	137
455	ML5900	S1	S1	8	18,5	443,5	165
455	ML6159	9	43	8	19	466,5	172
455	ML6233	U	C1	8	18,5	535	194
455	ML5851	S1	S1	8	18,5	631	265
460	ML5216	S1	S1	8	18,5	264	82
460	ML6000	U	U	8	18,5	285	105
460	ML5996	U	C1	8	18,5	300	106,5
460	ML5736	S1	U	8	18,5	404,5	163
460	ML5280	U	U	8	18,5	441,5	169
460	ML5108	U	U	8	18,5	450	170
460	ML6187	7b	44	8	19	453	185
460	ML5293	U	U	8	18,5	485	196
460	ML5459	S1	S1	8	18,5	485	193
460	ML6176	7b	13	8	19	495	183
460	ML5677	Y1	T1	8	18,5	499	205
460	ML5990	U	U	8	18,5	512	198
460	ML5214	S1	S1	8	18,5	517	200
460	ML6315	S1	S3	8	18,5	533	195
460	ML6291	U	C1	8	18,5	543,5	217
460	ML5718	U	U	10	22	547	220
460	ML5642	T1	T1	8	18,5	550	200
460	ML5248	U	U	10	22	567	225
460	ML6109	U	U	8	19	567	228
460	ML5288	U	U	8	18,5	570	230
460	ML5673	U	U	8	18,5	582	203
460	ML6332	U	U	8	18,5	585,5	245
460	ML5662	U	U	8	18,5	590	245
460	ML5578	U	U	8	18,5	650	250
460	ML5452	U	U	8	18,5	653	260
465	ML5466	S1	S1	8	18,5	280	80
465	ML5322	U	U	8	18,5	315	100
465	ML5967	S1	S1	8	18,5	387	139
465	ML5836	T1	T1	8	18,5	639	258
470	ML6142	U	C1	8	18,5	278	70
470	ML5727	U	U	8	18,5	320	105
470	ML6280	U	U	8	18,5	320	105
470	ML6189	7b	44	8	19	362,5	117
470	ML5473	S1	S1	8	18,5	395	150
470	ML5500	S1	S1	8	18,5	430	160
470	ML5661	U	U	8	18,5	440	170
470	ML5987	U	S1	8	18,5	449	160
470	ML5217	U	U	8	18,5	493	196
470	ML5185	S1	U	8	18,5	500	205
470	ML5198	S1	U	8	18,5	500	193
470	ML5225	S1	U	8	18,5	500	200
470	ML5391	U	U	8	18,5	510	208
470	ML6173	9	9	8	19	512	200
470	ML6276	U	13	8	18,5	558	216
470	ML5402	U	U	8	18,5	570	240

F1	Monroe®	↶	↷	Ød	ØD	Ext. L	S
470	ML5428	S1	S1	8	18,5	580	247
470	ML5279	S1	U	8	18,5	595	210
470	ML5311	U	U	8	18,5	640	190
470	ML5088	E2	E3	8	18,5	645	202,6
470	ML5089	E2	E3	8	18,5	645	202,6
475	ML6115	U	C1	8	18,5	492	175
475	ML6314	S1	S3	8	18,5	495	202
475	ML6318	P	P	8	18,5	512	212
475	ML5373	U	U	8	18,5	548	213
475	ML5571	T1	T1	8	18,5	550	222
475	ML5374	U	U	8	18,5	556	225
475	ML6044	S1	S1	8	18,5	643	204
475	ML5582	U	U	10	22	769	247
480	ML5526	S1	14	8	18,5	178	55
480	ML5273	U	U	8	18,5	278	90
480	ML5170	U	U	8	18,5	295	80
480	ML6103	U	C1	8	19	319,5	91
480	ML5445	10	10	8	18,5	365	145
480	ML6170	7b	13	8	19	370	131
480	ML6225	S1	S3	8	18,5	388	151
480	ML5723	S1	S1	8	18,5	405	160
480	ML5414	S1	S1	8	18,5	438	170
480	ML6344	U	C1	8	18,5	451	162
480	ML5702	P	S1	8	18,5	470	185
480	ML5871	S1	S1	8	18,5	480	185
480	ML5043	Y1	X1	8	18,5	490	180
480	ML5667	U	U	8	18,5	490,5	200
480	ML5100	S1	S1	8	18,5	500	204
480	ML5073	Y1	X1	8	18,5	501	207
480	ML5349	U	U	8	18,5	525	210
480	ML5440	S1	S1	8	18,5	534,5	220
480	ML5167	U	U	8	18,5	535	215
480	ML5388	U	U	8	18,5	565	215
480	ML5324	U	U	8	18,5	590	220
480	ML5430	U	U	8	18,5	590,5	245
480	ML6296	S1	S3	8	18,5	611	282
480	ML6207	U	C1	8	18,5	630	186
480	ML5654	U	U	8	18,5	657	275
480	ML5295	U	U	8	18,5	678	282
485	ML6145	S1	S3	8	18,5	314	92
485	ML6022	U	C1	8	18,5	506,5	186
485	ML5231	U	U	8	18,5	535	198
485	ML5173	U	U	8	18,5	555	228
485	ML5152	U	C1	8	18,5	595	250
490	ML5934	10	10	8	18,5	254	95
490	ML5135	U	U	8	18,5	279	95
490	ML5802	U	U	8	18,5	418	163
490	ML5894	U	U	8	18,5	446	170
490	ML5308	U	U	8	18,5	450	170
490	ML5460	S1	S1	8	18,5	494	185
490	ML5732	S1	S1	8	18,5	505	195
490	ML5478	S1	S1	8	18,5	515	200
490	ML5622	S1	S1	8	18,5	515	187
490	ML5684	U	U	8	18,5	515	190
490	ML5711	U	U	8	18,5	515	210
490	ML6130	P	U	8	19	522	210
490	ML5506	T1	T1	8	18,5	540	220
490	ML5378	U	S1	8	18,5	545	210
490	ML5354	U	U	8	18,5	570	230
495	ML6014	U	K	8	18,5	287	89
495	ML5962	U	C1	8	18,5	313,5	78,5
495	ML5652	J	S1	8	18,5	375	135
495	ML5109	U	U	8	18,5	544	207
500	ML6067	S1	S1	8	18,5	195,5	36

EXTENSION FORCE WITH EXTENDED PISTON ROD

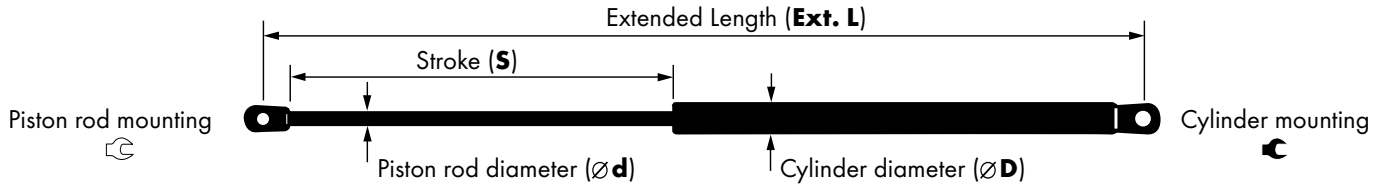
F1

F1	Monroe®	↺	↻	Ød	ØD	Ext. L	S
500	ML6019	U	U	8	18,5	222,5	71
500	ML5290	U	U	8	18,5	256	85
500	ML5483	S1	S1	8	18,5	280	95
500	ML5531	S1	T1	8	18,5	280	90
500	ML5154	U	U	8	18,5	298	83
500	ML5911	T1	T1	10	22	414	155
500	ML5212	U	U	8	18,5	417	155
500	ML5507	T1	T1	8	18,5	433	165
500	ML5096	U	U	8	18,5	447	172
500	ML6171	7b	13	8	19	486	185
500	ML5838	P	P	8	18,5	494	172
500	ML5080	U	U	8	18,5	495	192
500	ML5218	U	U	8	18,5	495	198
500	ML5094	U	U	8	18,5	500	204
500	ML5857	P	P	8	18,5	500	190
500	ML5132	S1	U	8	18,5	502	205
500	ML5123	S1	S1	8	18,5	515	210
500	ML5124	U	U	8	18,5	515	195
500	ML5372	U	U	8	18,5	546	215
500	ML5289	U	U	8	18,5	556	205
500	ML5782	T1	T1	8	18,5	558	235
500	ML5765	T1	T1	8	18,5	565	220
500	ML5138	U	U	8	18,5	566	204
500	ML5375	U	U	8	18,5	568	230
500	ML5437	S1	U	8	18,5	575	220
500	ML5940	S1	S1	8	18,5	585	246
500	ML6337	S2	15	8	18,5	585	235
500	ML6338	S2	16	8	18,5	585	235
500	ML5019	Y1	X1	8	18,5	600	250
500	ML5847	B2	A2	10	22	610	240
500	ML5848	B1	A1	10	22	610	240
500	ML6288	U	C1	8	18,5	660	276
500	ML5074	F1	Y3	10	22	798	350
505	ML6305	U	C1	8	18,5	684	209
510	ML5352	U	U	8	18,5	268	78
510	ML5786	U	U	8	18,5	280	90
510	ML6177	7b	44	8	19	294	88
510	ML5994	U	C1	8	18,5	345	119
510	ML5845	U	U	8	18,5	419	165
510	ML6214	S1	S3	8	18,5	470	165
510	ML5719	U	P	8	18,5	475	175
510	ML6129	U	U	8	19	488	195
510	ML6087	S1	S1	8	18,5	495	180,5
510	ML6005	S1	S1	8	18,5	538	220
510	ML5683	P	U	8	18,5	580	201
510	ML5888	T1	T1	8	18,5	585,5	235
510	ML5545	U	S1	8	18,5	596	210
510	ML5503	T1	T1	8	18,5	600	215
510	ML6017	U	U	8	18,5	604	225
510	ML5866	U	P	10	22	625	210
510	ML5344	U	U	8	18,5	632	230
510	ML5530	U	P	8	18,5	640	260
515	ML5219	U	U	8	18,5	495	182
515	ML6023	U	C1	8	18,5	506,5	186
515	ML5724	S1	S1	8	18,5	533	200
515	ML5126	S1	U	8	18,5	554	200
515	ML5130	U	C1	8	18,5	596,5	212
520	ML5341	U	U	8	18,5	263	80
520	ML5439	U	U	8	18,5	279	95
520	ML6106	U	C1	8	18,5	287	96
520	ML5930	U	U	8	18,5	331	115
520	ML5590	S1	12	8	18,5	346	100
520	ML5277	U	U	8	18,5	405	150
520	ML5941	S1	S1	8	18,5	449	179

F1	Monroe®	↺	↻	Ød	ØD	Ext. L	S
520	ML5294	U	U	8	18,5	485	196
520	ML5256	U	U	8	18,5	505	190
520	ML5377	U	S1	8	18,5	507	203
520	ML5408	U	U	8	18,5	511	199
520	ML5985	T1	T1	10	22	512	200
520	ML5064	U	U	8	18,5	527	219
520	ML5232	U	U	8	18,5	535	198
520	ML6327	U	C1	8	18,5	548	193
520	ML5122	U	U	8	18,5	570	232
520	ML5278	U	U	8	18,5	570	240
520	ML5401	U	U	8	18,5	570	230
525	ML6359	S1	S3	8	18,5	437	157
525	ML5774	T1	P	8	18,5	500	200
530	ML5193	U	U	8	18,5	279	90
530	ML6227	U	U	8	18,5	371	135
530	ML5801	U	U	8	18,5	415	160
530	ML6132	S1	S1	8	19	441	166
530	ML5032	U	U	8	18,5	473	188
530	ML6367	U	P	8	18,5	476	176
530	ML5416	U	U	8	18,5	481,5	199
530	ML5747	T1	T1	8	18,5	490	198
530	ML6226	U	C1	8	18,5	500	184
530	ML5227	S1	S1	8	18,5	502	200
530	ML5918	U	U	8	18,5	502	205
530	ML6220	S1	C1	8	18,5	519	185
530	ML5579	S1	S1	8	18,5	523	202
530	ML5690	S1	S1	8	18,5	530	175
530	ML5314	U	U	8	18,5	545	220
530	ML5379	U	S1	8	18,5	545	210
530	ML5824	S1	S1	8	18,5	558	235
530	ML5338	U	U	8	18,5	570	215
530	ML5476	S1	S1	8	18,5	574,5	230
530	ML5986	S1	C1	8	18,5	577	190
530	ML6168	13	44	8	19	703	282
530	ML5328	U	U	10	22	775	322
530	ML5621	U	U	10	22	775	322
535	ML5742	S1	U	8	18,5	450	180
535	ML5438	S1	S1	8	18,5	459,5	180
535	ML6135	S1	S3	8	18,5	473,5	162
535	ML5189	S1	S1	8	18,5	513	207
535	ML6117	U	C1	8	18,5	527	163
535	ML6143	U	U	8	18,5	547	222
535	ML5469	S1	S1	8	18,5	581,5	210
535	ML6125	S1	S1	8	19	665	238
540	ML5633	Y1	D	8	18,5	268	90
540	ML5549	T1	D	8	18,5	270	90
540	ML5932	S1	S1	8	18,5	291	65
540	ML6152	S1	P	8	18,5	361,5	121
540	ML5704	T1	T1	8	18,5	378	145
540	ML5757	U	U	8	18,5	473	182
540	ML5592	S1	S1	8	18,5	498	225
540	ML6289	U	C1	8	18,5	499	206
540	ML6172	7b	13	8	19	520	198
540	ML5983	U	P	10	22	524	212
540	ML6155	7b	44	8	19	536	225
540	ML5119	U	U	8	18,5	540	196
540	ML5424	U	S1	8	18,5	567	193
540	ML6321	U	P	8	18,5	589	170
540	ML5501	Y2	D	8	18,5	600	250
540	ML5384	U	S1	8	18,5	606,5	230
540	ML6354	U	U	10	22	657	200
540	ML5835	M	O	10	22	699	257
545	ML5641	S1	S1	8	18,5	511,5	172
545	ML5666	U	U	8	18,5	531	173

EXTENSION FORCE WITH EXTENDED PISTON ROD

F1

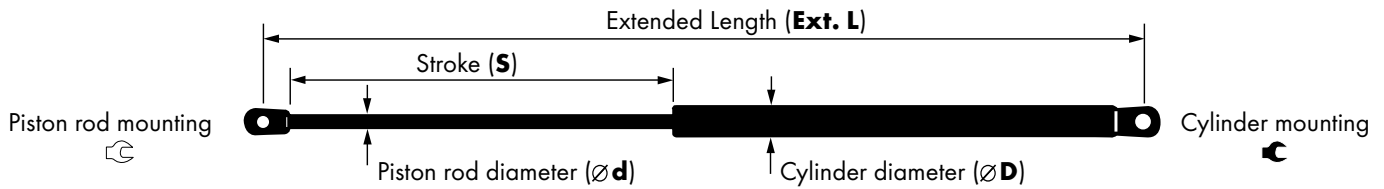

F1	Monroe®	C	C	Ød	ØD	Ext. L	S
550	ML5558	U	T1	8	18,5	280	90
550	ML5710	U	U	8	18,5	299	109
550	ML5761	U	U	8	18,5	305	105
550	ML5793	S1	S1	8	18,5	315	100
550	ML5045	U	C1	8	18,5	405	160
550	ML5653	S1	U	8	18,5	439,5	157
550	ML5699	P	S1	8	18,5	445	183
550	ML5831	U	S1	8	18,5	450	180
550	ML5792	U	P	8	18,5	480	200
550	ML6230	U	P	8	18,5	498	207
550	ML5178	U	U	8	18,5	507	207
550	ML5156	P	P	8	18,5	508	195
550	ML5168	U	U	8	18,5	512	200
550	ML5177	U	U	8	18,5	515	210
550	ML5644	T1	D	8	18,5	515	215
550	ML5828	U	P	8	18,5	547	220
550	ML6202	U	C1	8	18,5	554	239
550	ML5381	U	S1	8	18,5	557	215
550	ML5319	U	U	8	18,5	558	200
550	ML5912	S1	U	8	18,5	567	195
550	ML6194	U	C1	8	18,5	580	179
550	ML5504	T1	T1	8	18,5	600	215
550	ML6241	S1	S3	8	18,5	632,5	216
555	ML5351	U	U	8	18,5	357	128
555	ML6316	P	P	8	18,5	526	207
555	ML6165	7b	44	8	19	687	208
560	ML6147	S1	S1	8	18,5	225	60
560	ML5535	Y1	T1	8	18,5	241	70
560	ML5808	S1	S1	8	18,5	256	58
560	ML5818	U	U	8	18,5	282	98
560	ML5502	S1	S1	8	18,5	300	99
560	ML5302	U	U	8	18,5	385	138
560	ML5794	T1	T1	8	18,5	462,5	190
560	ML5082	U	U	8	18,5	469,5	171
560	ML5979	U	U	8	18,5	490	189
560	ML6157	7b	44	8	19	500	195
560	ML6340	S1	S3	8	18,5	516	187
560	ML5313	U	U	8	18,5	526	206
560	ML5176	S1	U	8	18,5	552	200
560	ML5412	S1	U	8	18,5	565	210
560	ML5397	U	U	8	18,5	568	230
560	ML6042	S1	S1	8	18,5	580	200
560	ML5305	U	U	8	18,5	610	200
560	ML5627	U	U	8	18,5	610	200
560	ML5585	O	O	10	22	613,5	248
560	ML5892	S1	S1	8	18,5	830	300
565	ML6099	S1	U	8	18,5	344,5	88,5
565	ML5647	P	S1	8	18,5	485	200
565	ML5221	U	U	8	18,5	495	182
565	ML5253	U	U	8	18,5	496,5	192
565	ML5756	U	P	8	18,5	640	255
570	ML6110	S1	S3	8	18,5	283	84
570	ML6215	S1	S3	8	18,5	420	135
570	ML6206	U	C1	8	18,5	455	160
570	ML5258	U	U	8	18,5	471	184
570	ML5721	U	U	8	18,5	474	190
570	ML5963	S1	S1	8	18,5	495	180,5
570	ML5086	S1	S1	8	18,5	526	207
570	ML5346	U	U	8	18,5	571	208
570	ML5283	U	U	8	18,5	627	230
570	ML5626	U	U	8	18,5	627	230
570	ML5505	T1	T1	8	18,5	630	220
575	ML5205	U	U	8	18,5	625	253
580	ML5376	U	S1	8	18,5	280	90

F1	Monroe®	C	C	Ød	ØD	Ext. L	S
580	ML6121	U	C1	8	18,5	285	100
580	ML5335	S1	S1	8	18,5	310	110
580	ML5263	S1	S1	8	18,5	319	110
580	ML5656	P	P	8	18,5	469,5	185
580	ML6016	U	S3	8	18,5	479	174
580	ML5569	S1	S1	8	18,5	485	185
580	ML5872	S1	S1	8	18,5	516,5	150
580	ML5991	U	U	8	18,5	557	220
580	ML5554	U	T1	10	22	573,5	215
580	ML6218	U	C1	8	18,5	600	195
585	ML5486	S1	S1	8	18,5	434	153
585	ML5632	Y1	D	8	18,5	486	170
585	ML5997	P	S1	8	18,5	505	205
585	ML5190	S1	S1	8	18,5	513	207
585	ML5760	P	U	8	18,5	515	196
585	ML5984	U	P	10	22	524	212
585	ML5233	U	U	8	18,5	535	198
585	ML5772	T1	P	8	18,5	539	218
585	ML6306	U	P	10	22	555	202
590	ML5417	S1	S1	8	18,5	275	90
590	ML6158	7b	44	8	19	281,5	77,5
590	ML5310	U	U	8	18,5	310	89
590	ML5844	U	U	8	18,5	310	110
590	ML5343	U	U	8	18,5	448	180
590	ML5413	S1	U	8	18,5	472	175
590	ML5383	U	S1	8	18,5	473,5	170
590	ML5137	U	U	8	18,5	542	193
590	ML6330	U	15	8	18,5	560	190
590	ML5141	U	U	10	22	567	221
590	ML6002	U	U	10	22	569,5	155
590	ML6144	S1	C1	8	18,5	587,5	167,5
590	ML6124	U	P	8	19	590	225
590	ML5693	P	S1	8	18,5	625	210
595	ML5291	U	U	8	18,5	501	175
595	ML5755	U	P	8	18,5	640	255
600	ML6292	S1	S3	8	18,5	234	60
600	ML5594	Y5	X3	8	18,5	255	86
600	ML5748	S1	U	8	18,5	255	85
600	ML5532	S1	T1	8	18,5	280	90
600	ML5778	S1	U	8	18,5	285	105
600	ML6091	U	U	8	18,5	291	91
600	ML5487	S1	S1	8	18,5	298	90
600	ML5008	Y1	X1	8	18,5	365	140
600	ML5682	U	U	8	18,5	420	162
600	ML6071	U	U	8	18,5	431	160
600	ML5175	U	C1	8	18,5	440	169
600	ML5121	S1	S1	8	18,5	450	175
600	ML5257	U	U	8	18,5	470	182
600	ML6119	U	C1	8	18,5	480	189
600	ML5425	U	C1	8	18,5	491	205
600	ML5613	Y1	D	8	18,5	500	201
600	ML5856	U	U	8	18,5	500	190
600	ML5125	U	U	8	18,5	508	195
600	ML6153	7b	44	8	19	515	210
600	ML6128	S1	S1	8	19	523	200
600	ML6224	O	O	8	18,5	565	165
600	ML6357	P	C1	8	18,5	584	194
600	ML5456	U	U	8	18,5	610	200
600	ML5363	U	U	8	18,5	632	215
600	ML5455	U	U	8	18,5	632	215
610	ML6160	7b	44	8	19	281,5	77,5
610	ML5260	U	U	8	18,5	293	80
610	ML6097	S1	S1	8	18,5	334	120
610	ML6203	U	C1	8	18,5	475	150

EXTENSION FORCE

EXTENSION FORCE WITH EXTENDED PISTON ROD

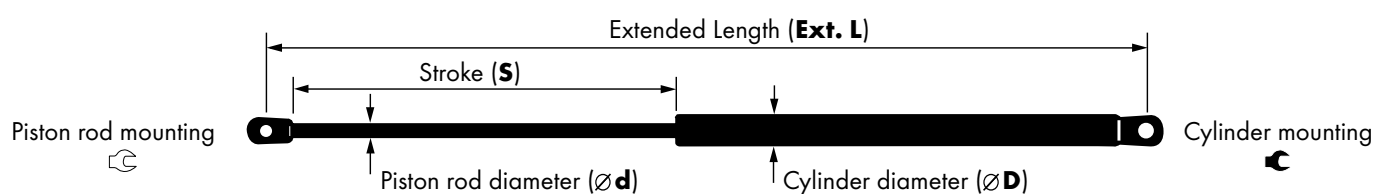
F1

F1	Monroe®	☺	☻	∅d	∅D	Ext. L	S
610	ML5380	U	S1	8	18,5	485	187
610	ML5495	U	U	8	18,5	490	195
610	ML5657	S1	S1	8	18,5	495	205
610	ML5722	U	U	10	22	505	205
610	ML5106	U	D	8	18,5	514,5	217
610	ML6013	S1	S1	10	22	515,5	205
610	ML6116	U	C1	8	18,5	527	163
610	ML5334	U	U	8	18,5	549,5	200
610	ML6162	7b	44	8	19	652	240
610	ML5528	M	O	10	22	697	257
610	ML5834	M	O	10	22	699	257
615	ML5728	U	U	8	18,5	375	145
620	ML5442	U	U	8	18,5	348	120
620	ML5303	S1	S1	8	18,5	365	135
620	ML5449	U	U	8	18,5	405	160
620	ML5103	U	U	8	18,5	510	202
620	ML5889	S1	S1	8	18,5	527	188
620	ML5707	U	U	8	18,5	545	210
620	ML5477	S1	S1	8	18,5	574,5	230
620	ML5527	O	O	10	22	613,5	248
625	ML5826	U	C1	8	18,5	520	180
625	ML5783	U	P	8	18,5	585	190
625	ML5948	U	S1	10	22	620	225
630	ML5431	U	U	8	18,5	256	85
630	ML5234	U	U	10	22	278	90
630	ML5104	U	S1	8	18,5	280	95,5
630	ML5753	U	U	8	18,5	470	160
630	ML5929	P	P	10	22	498	191
630	ML6038	T1	T1	10	22	500	175
630	ML5616	S1	U	8	18,5	570	200
630	ML5454	U	U	8	18,5	627	230
630	ML5128	S1	S1	10	22	690	280
630	ML5837	T1	T1	8	18,5	690	300
630	ML5329	U	U	10	22	772	322
635	ML6012	P	P	10	22	496	180
635	ML5110	U	U	8	18,5	500	170
635	ML5238	S1	P	8	18,5	500	200
635	ML5240	P	P	10	22	500	200
640	ML5688	S1	S1	8	18,5	288	104
640	ML5523	S1	12	8	18,5	312	100
640	ML5773	U	U	8	18,5	475	195
640	ML5332	U	U	8	18,5	485	165
640	ML5475	U	U	8	18,5	520	175
640	ML5586	O	O	10	22	613,5	248
640	ML5543	U	U	8	18,5	695	272
645	ML6183	9	13	8	19	487	190
645	ML5958	U	P	8	18,5	588	198
650	ML5686	U	U	8	18,5	165	40
650	ML5223	U	U	10	22	298	95
650	ML6242	S1	S3	8	18,5	301	104
650	ML5553	U	U	10	22	310	89
650	ML5800	U	U	8	18,5	333	117
650	ML6346	S1	C1	8	18,5	462	142
650	ML5746	U	P	8	18,5	475	184
650	ML6178	7b	44	8	19	477	176
650	ML5635	Y1	D	8	18,5	500	195
650	ML6080	U	U	8	18,5	538	205
650	ML5142	U	U	10	22	567	221
650	ML5816	T1	T1	10	22	570	240
650	ML6356	U	U	10	22	697	200
655	ML5224	U	K	10	22	465	140
655	ML5770	P	P	8	18,5	605	242
660	ML5330	U	U	10	22	250	74
660	ML5446	T1	T1	10	22	382	140

F1	Monroe®	☺	☻	∅d	∅D	Ext. L	S
660	ML5513	T1	T1	10	22	382	140
660	ML6169	7b	13	8	19	452	170
660	ML6239	U	C1	8	18,5	485	165
660	ML6051	U	U	8	18,5	500	146
660	ML6331	U	U	10	22	520	180
660	ML5581	U	U	10	22	527	200
660	ML5246	U	U	10	22	569	240
660	ML5671	U	U	8	18,5	627	205
665	ML5433	U	U	10	22	520	180
670	ML5533	T1	T1	10	22	272	90
670	ML6104	U	C1	8	18,5	299	65,5
670	ML6167	7b	44	8	19	537	180
670	ML6277	U	C1	8	18,5	554	200
670	ML5893	S1	S1	8	18,5	569	240
670	ML5555	U	T1	10	22	573,5	215
670	ML5968	U	U	8	18,5	600	225
670	ML5113	T1	T1	8	18,5	700	300
670	ML6287	U	K	10	22	743	237
670	ML6299	U	U	10	22	759	256
670	ML5514	U	U	10	22	850	340
680	ML5860	S1	S1	8	18,5	214	62
680	ML5524	T1	T1	10	22	273	92
680	ML6076	U	T1	10	22	282	100
680	ML6163	7b	44	8	19	298	106
680	ML5630	S1	S1	10	22	431	121
680	ML5989	U	K	10	22	595	205
690	ML5226	U	S1	10	22	260	89
690	ML5512	U	U	10	22	480	173
690	ML5511	U	U	10	22	483	175
690	ML5239	P	U	10	22	500	195
690	ML6113	Q	Q	10	22	539	163
690	ML6297	U	U	10	22	650	260
700	ML5675	U	U	10	22	175	45
700	ML6037	U	C1	8	18,5	241	76
700	ML6249	S1	S1	10	22	287	107
700	ML5745	U	U	10	22	298	80
700	ML5811	U	U	8	18,5	323	103
700	ML5336	S1	S1	10	22	333	100
700	ML5426	U	U	10	22	418	148
700	ML5415	U	U	10	22	455	127
700	ML5817	P	U	10	22	482	185,5
700	ML6179	13	25	10	22	482	155
700	ML6057	U	C1	10	22	598,5	186
700	ML6231	U	U	8	18,5	686	295
700	ML5518	U	U	10	22	730	200
700	ML6300	U	U	10	22	739	202
705	ML6238	S1	S3	8	18,5	440	150
705	ML6073	U	U	8	18,5	482,5	195
710	ML5751	T1	T1	10	22	300	70
710	ML5557	U	U	10	22	492	188
710	ML5781	U	S1	10	22	535	183
710	ML5787	T1	T1	10	22	550	160
710	ML5249	P	P	10	22	685	250
715	ML6213	U	C1	8	18,5	550	173
715	ML5797	T1	T1	10	22	556	224
720	ML5525	T1	T1	10	22	273	92
720	ML5769	U	S1	10	22	285	100
720	ML5539	U	U	10	22	489	144
720	ML6308	S1	S1	10	22	506	161
720	ML6201	U	K	10	22	796,5	246,5
725	ML5806	U	P	10	22	560	178
725	ML5709	U	U	10	22	736,5	310
730	ML5744	U	U	10	22	298	80
730	ML6029	U	13	10	22	301	92

EXTENSION FORCE WITH EXTENDED PISTON ROD

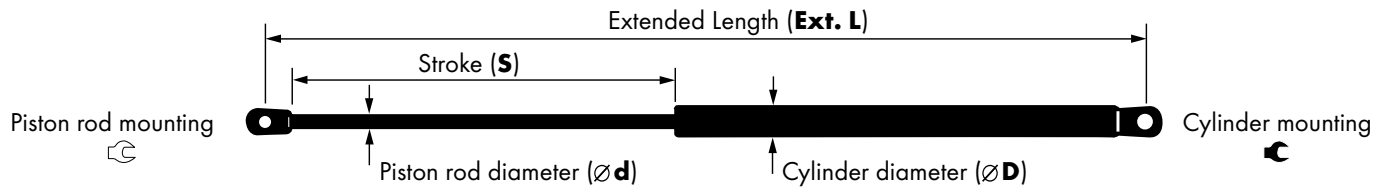
F1

F1	Monroe®	↺	↻	Ød	ØD	Ext. L	S
730	ML5580	U	U	10	22	520	185
730	ML5228	U	K	10	22	560	210
730	ML5516	T1	T1	10	22	905	307
730	ML5550	T1	T1	10	22	905	307
740	ML5927	U	T1	8	18,5	274	90
740	ML6360	S1	S3	8	18,5	377	130
740	ML5331	U	K	10	22	450	162
740	ML5510	U	U	10	22	483	175
740	ML6216	S1	K	10	22	542	175
740	ML5443	U	U	10	22	603	220
740	ML6234	U	K	10	22	640	240
745	ML6298	U	U	10	22	650	260
750	ML6102	U	P	10	22	483,5	148
750	ML6075	U	K	10	22	533	220
750	ML6058	S1	S1	10	22	537	198
750	ML5591	U	Q	10	22	545	195
750	ML5245	U	U	10	22	569	240
750	ML6053	U	C1	8	18,5	652	218
755	ML5716	U	U	10	22	667	255
760	ML5583	U	U	10	22	195	50
760	ML5519	U	U	10	22	730	200
765	ML5947	P	P	10	22	665	195
770	ML5743	U	P	10	22	505	170
770	ML6209	U	U	10	22	655	195/260
770	ML5118	P	P	10	22	685	250
775	ML6237	S1	S3	8	18,5	440	150
780	ML5612	U	U	10	22	501	175
790	ML6068	U	C1	8	18,5	227	57
800	ML5441	S1	S1	10	22	326	115
800	ML5540	S2	S2	10	22	364	130
800	ML5839	U	K	10	22	390	148
800	ML5229	U	U	10	22	560	210
800	ML6055	U	U	10	22	661,5	260,5
810	ML5429	U	U	10	22	550	235
810	ML5537	U	U	10	22	603	198
819	ML5515	U	U	10	22	722	210
820	ML5628	U	U	10	22	265	80
830	ML6285	S2	S2	10	22	495	145
830	ML5247	U	U	10	22	569	240
830	ML5127	U	U	10	22	591	200
830	ML5251	P	P	10	22	685	250
838	ML6001	Q	Q	10	22	429	136
850	ML5559	U	S2	10	22	235	52
850	ML5085	U	U	10	22	249	67
850	ML5076	U	U	10	22	550	235
850	ML5538	U	U	10	22	603	198
850	ML6301	U	U	10	22	739	202
870	ML5750	U	U	10	22	720	280
880	ML6244	U	K	10	22	391,5	158
880	ML6195	U	U	10	22	656	186
910	ML6188	7b	25	10	22	490	155
910	ML5105	U	U	10	22	569	240
910	ML5250	P	P	10	22	685	250
970	ML5575	U	P	10	22	755	210
990	ML5771	P	P	10	22	574	198
1050	ML5944	P	P	10	22	430,5	130
1050	ML5950	U	U	10	22	700	172
1080	ML5576	U	U	10	22	755	210
1080	ML5833	U	P	10	22	755	210
1100	ML5517	U	U	10	22	195	55
1180	ML6149	G	G	10	22	250	72
1190	ML6092	O	M	14	28	308	88
1200	ML5685	M	O	14	28	320	85
1200	ML5982	1	1	14	28	342	105

F1	Monroe®	↺	↻	Ød	ØD	Ext. L	S
1300	ML6021	1	1	14	28	347,5	91,5
1340	ML5852	G	G	14	28	399	86
1400	ML5674	1	1	14	28	325	100
1450	ML6030	M	M	14	28	312,5	75,5
1550	ML5637	O	O	14	28	396	108
1600	ML5529	O	M	14	28	270	70

EXTENDED LENGTH

Ext. L

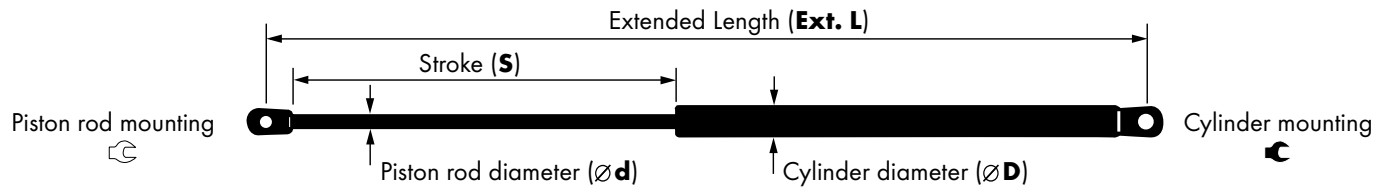

Ext. L	Monroe®	↺	↻	Ød	ØD	S	F1
155	ML5974	T1	T1	6	15	40	400
165	ML5686	U	U	8	18,5	40	650
175	ML5675	U	U	10	22	45	700
178	ML5526	S1	14	8	18,5	55	480
185	ML5546	R	R	6	15	55	100
195	ML5583	U	U	10	22	50	760
195	ML5517	U	U	10	22	55	1100
195,5	ML6066	S1	S1	6	15	60	350
195,5	ML6067	S1	S1	8	18,5	36	500
201	ML5791	S1	U	8	18,5	52	250
201	ML5978	S1	S1	8	18,5	60	450
214	ML5860	S1	S1	8	18,5	62	680
215	ML5389	S1	S1	8	18,5	48	420
222,5	ML6019	U	U	8	18,5	71	500
225	ML5629	R	R	6	15	80	100
225	ML6147	S1	S1	8	18,5	60	560
226	ML5496	Y1	D	8	18,5	63	100
227	ML6068	U	C1	8	18,5	57	790
232,5	ML6015	U	U	8	18,5	65	305
234	ML6292	S1	S3	8	18,5	60	600
235	ML5559	U	S2	10	22	52	850
238	ML5810	U	U	8	18,5	62	165
240	ML5404	U	U	8	18,5	74	300
240	ML5803	S1	S1	8	18,5	70	380
240	ML6333	U	M6	8	18,5	85	410
241	ML5535	Y1	T1	8	18,5	70	560
241	ML6037	U	C1	8	18,5	76	700
242	ML6031	S1	10	6	15	74	325
242	ML5522	10	10	8	18,5	84	380
244	ML5643	S1	S1	6	15	90	400
245	ML5611	Y1	D	8	18,5	76	330
249	ML5085	U	U	10	22	67	850
250	ML5330	U	U	10	22	74	660
250	ML6149	G	G	10	22	72	1180
252	ML5764	U	U	8	18,5	85	425
254	ML5639	Y1	D	8	18,5	85	340
254	ML5596	Y4	X1	6	15	95	350
254	ML5566	10	10	8	18,5	90	420
254	ML5934	10	10	8	18,5	95	490
255	ML5922	S1	S3	8	18,5	78	350
255	ML5595	Y5	X3	8	18,5	86	370
255	ML5594	Y5	X3	8	18,5	86	600
255	ML5748	S1	U	8	18,5	85	600
256	ML5030	Y1	X1	8	18,5	86	180
256	ML5018	Y1	X1	8	18,5	86	280
256	ML5290	U	U	8	18,5	85	500
256	ML5808	S1	S1	8	18,5	58	560
256	ML5431	U	U	8	18,5	85	630
260	ML5226	U	S1	10	22	89	690
263	ML5341	U	U	8	18,5	80	520
264	ML6127	U	S1	8	19	88	355
264	ML5215	S1	S1	8	18,5	82	370
264	ML5216	S1	S1	8	18,5	82	460
265	ML5628	U	U	10	22	80	820
268	ML5617	N	N	8	18,5	83,5	450
268	ML5352	U	U	8	18,5	78	510
268	ML5633	Y1	D	8	18,5	90	540
270	ML6248	S1	S1	6	15	102	130
270	ML5921	S1	S1	8	18,5	82	380
270	ML5481	S1	S1	8	18,5	75	420
270	ML5549	T1	D	8	18,5	90	540
270	ML5529	O	M	14	28	70	1600
272	ML5533	T1	T1	10	22	90	670
273	ML6011	U	U	8	18,5	85	420

Ext. L	Monroe®	↺	↻	Ød	ØD	S	F1
273	ML5524	T1	T1	10	22	92	680
273	ML5525	T1	T1	10	22	92	720
274	ML6148	S1	S1	8	18,5	95	320
274	ML5927	U	T1	8	18,5	90	740
275	ML5417	S1	S1	8	18,5	90	590
278	ML5274	U	U	8	18,5	90	430
278	ML6142	U	C1	8	18,5	70	470
278	ML5273	U	U	8	18,5	90	480
278	ML5234	U	U	10	22	90	630
279	ML5135	U	U	8	18,5	95	490
279	ML5439	U	U	8	18,5	95	520
279	ML5193	U	U	8	18,5	90	530
280	ML5419	S1	S1	8	18,5	95	390
280	ML6120	U	U	8	18,5	95	395
280	ML5467	S1	S1	8	18,5	80	420
280	ML5466	S1	S1	8	18,5	80	465
280	ML5483	S1	S1	8	18,5	95	500
280	ML5531	S1	T1	8	18,5	90	500
280	ML5786	U	U	8	18,5	90	510
280	ML5558	U	T1	8	18,5	90	550
280	ML5376	U	S1	8	18,5	90	580
280	ML5532	S1	T1	8	18,5	90	600
280	ML5104	U	S1	8	18,5	95,5	630
281,5	ML6158	7b	44	8	19	77,5	590
281,5	ML6160	7b	44	8	19	77,5	610
282	ML5818	U	U	8	18,5	98	560
282	ML6076	U	T1	10	22	100	680
283	ML6047	S1	S1	8	18,5	87	400
283	ML5663	U	U	8	18,5	101,5	450
283	ML6110	S1	S3	8	18,5	84	570
284	ML5063	U	U	8	18,5	100	315
285	ML5980	U	U	8	18,5	104	230
285	ML5323	U	U	8	18,5	95	290
285	ML6101	S1	S1	6	15	100	300
285	ML6136	U	C1	8	18,5	90	410
285	ML6000	U	U	8	18,5	105	460
285	ML6121	U	C1	8	18,5	100	580
285	ML5778	S1	U	8	18,5	105	600
285	ML5769	U	S1	10	22	100	720
286	ML5471	S1	S1	8	18,5	100	310
287	ML5259	U	U	8	18,5	99	365
287	ML6014	U	K	8	18,5	89	495
287	ML6106	U	C1	8	18,5	96	520
287	ML6249	S1	S1	10	22	107	700
288	ML5536	U	Q	8	18,5	95	250
288	ML6253	S1	S3	8	18,5	94	260
288	ML5688	S1	S1	8	18,5	104	640
288,5	ML5975	S1	S3	8	18,5	100	380
289	ML6020	S1	10	6	15	113	350
290	ML6107	S1	S3	8	19	102	395
291	ML5698	S1	U	8	18,5	107	380
291	ML5932	S1	S1	8	18,5	65	540
291	ML6091	U	U	8	18,5	91	600
292	ML6004	S1	S1	8	18,5	88	410
293	ML5946	U	C	8	18,5	104	280
293	ML5260	U	U	8	18,5	80	610
294	ML6177	7b	44	8	19	88	510
295	ML5301	U	U	8	18,5	100	380
295	ML6222	U	C1	8	18,5	95/108	380
295	ML5170	U	U	8	18,5	80	480
296	ML5861	S1	S1	8	18,5	95	250
297	ML5813	S1	S1	6	15	112,5	240
298	ML6112	U	C	8	18,5	94	430
298	ML5154	U	U	8	18,5	83	500

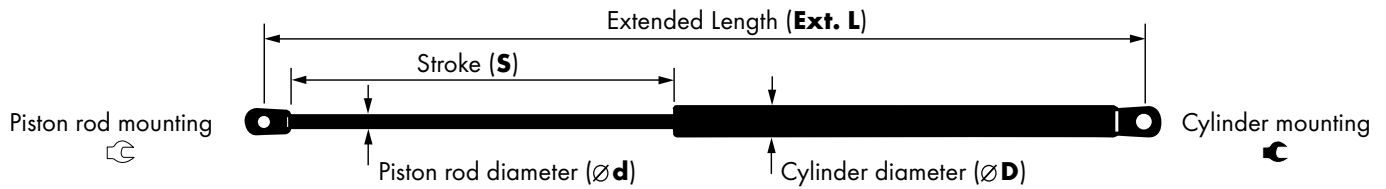

Ext. L	Monroe®	↺	↻	Ød	ØD	S	F1
298	ML5487	S1	S1	8	18,5	90	600
298	ML5223	U	U	10	22	95	650
298	ML6163	7b	44	8	19	106	680
298	ML5745	U	U	10	22	80	700
298	ML5744	U	U	10	22	80	730
299	ML5710	U	U	8	18,5	109	550
299	ML6104	U	C1	8	18,5	65,5	670
299,5	ML6094	S2	S2	8	18,5	88	370
300	ML6154	9	43	8	16	113	400
300	ML5182	S1	S1	8	18,5	100	410
300	ML5996	U	C1	8	18,5	106,5	460
300	ML5502	S1	S1	8	18,5	99	560
300	ML5751	T1	T1	10	22	70	710
301	ML6242	S1	S3	8	18,5	104	650
301	ML6029	U	13	10	22	92	730
305	ML5640	T1	T1	6	15	109	130
305	ML6062	S1	D	8	18,5	105	370
305	ML5928	S1	S1	8	18,5	96	410
305	ML6272	U	S2	8	18,5	105	412
305	ML5761	U	U	8	18,5	105	550
305,5	ML5179	S1	S1	6	15	121	45
308	ML6092	O	M	14	28	88	1190
310	ML6114	S1	H1	6	15	122	255
310	ML5729	U	U	8	18,5	110	400
310	ML5355	U	U	8	18,5	95	430
310	ML5335	S1	S1	8	18,5	110	580
310	ML5310	U	U	8	18,5	89	590
310	ML5844	U	U	8	18,5	110	590
310	ML5553	U	U	10	22	89	650
312	ML5523	S1	12	8	18,5	100	640
312,5	ML6030	M	M	14	28	75,5	1450
313	ML5562	S1	S1	8	18,5	112	330
313,5	ML5962	U	C1	8	18,5	78,5	495
314	ML5945	P	U	6	15	110	355
314	ML6145	S1	S3	8	18,5	92	485
314,5	ML6065	U	C1	8	18,5	116	220
314,5	ML5804	U	U	8	18,5	116	330
315	ML5411	S1	U	8	18,5	105	370
315	ML5321	U	U	8	18,5	100	420
315	ML5740	S1	U	8	18,5	120	440
315	ML5322	U	U	8	18,5	100	465
315	ML5793	S1	S1	8	18,5	100	550
318	ML5766	S1	S1	8	18,5	120	380
319	ML5646	Y5	X3	8	18,5	100	370
319	ML6251	Y5	X3	8	18,5	100	430
319	ML5263	S1	S1	8	18,5	110	580
319,5	ML6006	U	U	8	18,5	120	410
319,5	ML6103	U	C1	8	19	91	480
320	ML5488	S1	S1	8	18,5	100	360
320	ML5727	U	U	8	18,5	105	470
320	ML6280	U	U	8	18,5	105	470
320	ML5685	M	O	14	28	85	1200
323	ML5811	U	U	8	18,5	103	700
324	ML5095	U	U	8	18,5	115	290
325	ML5674	1	1	14	28	100	1400
326	ML5441	S1	S1	10	22	115	800
329	ML6193	U	C1	8	18,5	118	380
330	ML5619	N	N	8	18,5	116	340
331	ML5930	U	U	8	18,5	115	520
333	ML5800	U	U	8	18,5	117	650
333	ML5336	S1	S1	10	22	100	700
334	ML6063	S1	P	6	15	130	270
334	ML6228	U	C1	8	18,5	117	370
334	ML6097	S1	S1	8	18,5	120	610

Ext. L	Monroe®	↺	↻	Ød	ØD	S	F1
337,5	ML6133	S1	S1	8	19	120	365
338	ML6033	U	U	8	18,5	119	420
340	ML6118	U	C1	8	18,5	113	430
342	ML5982	1	1	14	28	105	1200
344,5	ML6098	S1	U	8	18,5	88,5	450
344,5	ML6099	S1	U	8	18,5	88,5	565
345	ML5789	U	U	8	18,5	122	350
345	ML6108	S1	S1	8	19	128	450
345	ML5994	U	C1	8	18,5	119	510
346	ML5999	U	U	6	15	136	340
346	ML5590	S1	12	8	18,5	100	520
346,5	ML6326	U	C1	8	18,5	60	400
347,5	ML6021	1	1	14	28	91,5	1300
348	ML6204	S1	S3	8	18,5	113	375
348	ML5442	U	U	8	18,5	120	620
350	ML5163	S1	S1	8	18,5	100	320
350	ML5680	U	U	8	18,5	130	440
352	ML5356	U	U	8	18,5	110	150
355	ML5910	U	S1	8	18,5	135	115
355	ML5696	P	U	8	18,5	120	350
357	ML5351	U	U	8	18,5	128	555
359	ML6090	1	H	6	15	150	180
361,5	ML6152	S1	P	8	18,5	121	540
362	ML5823	S1	S1	6	15	138	100
362	ML5017	U	X2	8	18,5	135	190
362	ML6141	S1	S1	8	18,5	112	260
362,5	ML6245	U	C1	8	18,5	117	390
362,5	ML6189	7b	44	8	19	117	470
363	ML6355	U	C1	8	18,5	130	150
363	ML5490	S1	S1	8	18,5	132	370
364	ML5489	S1	S1	8	18,5	132	310
364	ML5540	S2	S2	10	22	130	800
365	ML5552	S1	S1	6	15	135	135
365	ML5365	U	U	8	18,5	135	180
365	ML5366	U	U	8	18,5	135	240
365	ML6255	U	C1	8	18,5	139	360
365	ML5444	10	10	8	18,5	145	410
365	ML6347	S1	S3	8	18,5	107	450
365	ML5445	10	10	8	18,5	145	480
365	ML5008	Y1	X1	8	18,5	140	600
365	ML5303	S1	S1	8	18,5	135	620
365,5	ML5906	1	H	6	15	150	290
366	ML5670	S1	S1	8	18,5	117	280
367	ML6350	S1	S3	8	18,5	105	280
367	ML5421	10	10	6	15	145	320
367	ML6186	7b	13	8	19	144	420
368	ML6286	S1	S3	8	18,5	138	380
369	ML6281	S1	S3	8	18,5	110	210
369	ML5658	S1	S1	8	18,5	110	320
370	ML5694	S1	S1	8	18,5	110	320
370	ML6170	7b	13	8	19	131	480
371	ML6227	U	U	8	18,5	135	530
374	ML5563	S1	S1	8	18,5	140	350
375	ML6146	S1	S1	6	15	118	180
375	ML5924	U	C1	8	18,5	144	280
375	ML5830	U	P	8	18,5	140	390
375	ML5652	J	S1	8	18,5	135	495
375	ML5728	U	U	8	18,5	145	615
376	ML6161	7b	44	8	19	150	120
376	ML5943	S1	S3	8	18,5	145	390
377	ML6360	S1	S3	8	18,5	130	740
378	ML6131	U	U	8	18,5	146	300
378	ML5704	T1	T1	8	18,5	145	540
380	ML5998	C	U	8	18,5	127	200

EXTENDED LENGTH

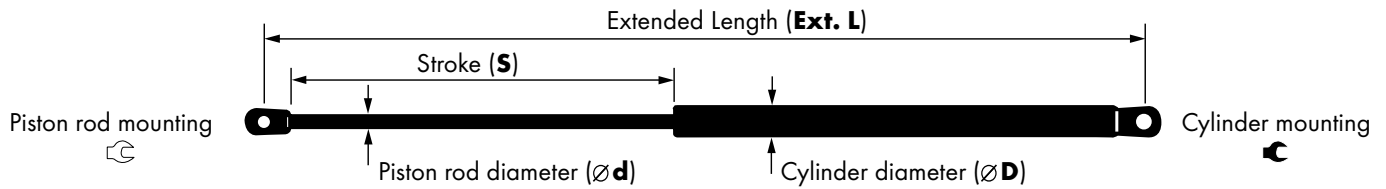

Ext. L	Monroe®	↺	↻	Ød	ØD	S	F1
380	ML6317	U	C1	8	18,5	110/120	310
382	ML6349	U	C1	8	18,5	136	270
382	ML5446	T1	T1	10	22	140	660
382	ML5513	T1	T1	10	22	140	660
383	ML5891	S1	S1	8	18,5	137	455
385	ML5762	P	U	8	18,5	150	140
385	ML5302	U	U	8	18,5	138	560
386,5	ML6035	P	P	8	18,5	145	160
386,5	ML5714	U	P	8	18,5	150	350
387	ML5967	S1	S1	8	18,5	139	465
388	ML6225	S1	S3	8	18,5	151	480
390	ML5832	U	P	8	18,5	155	360
390	ML5839	U	K	10	22	148	800
391,5	ML6244	U	K	10	22	158	880
392	ML5624	P	T1	8	18,5	150	300
393	ML6137	U	U	8	18,5	150	170
394	ML6026	U	13	8	18,5	149	400
395	ML5387	U	U	8	18,5	148	180
395	ML5472	S1	S1	8	18,5	150	230
395	ML5706	P	U	8	18,5	158	440
395	ML5473	S1	S1	8	18,5	150	470
396	ML5637	O	O	14	28	108	1550
397	ML6028	S1	12	8	18,5	158	295
398	ML5623	S1	S1	8	18,5	120	180
399	ML6191	S1	S3	8	18,5	160	250
399	ML5852	G	G	14	28	86	1340
400	ML5870	S1	S1	6	15	160	230
400	ML5484	S1	S1	8	18,5	150	280
400	ML5392	S1	S1	8	18,5	149	300
400	ML5689	S1	P	8	18,5	160	330
400	ML5855	S1	S1	8	18,5	139	400
402	ML5111	U	C1	8	18,5	160	390
402	ML6269	U	C1	8	18,5	160	390
402,5	ML6150	U	U	8	18,5	160	150
403	ML6351	S1	S3	8	18,5	157	120
404	ML6061	U	U	8	18,5	157	260
404,5	ML6081	S1	S1	8	18,5	160	310
404,5	ML5736	S1	U	8	18,5	163	460
405	ML5846	U	D	8	18,5	164	270
405	ML5649	U	U	8	18,5	160	300
405	ML5275	U	U	8	18,5	160	310
405	ML5723	S1	S1	8	18,5	160	480
405	ML5277	U	U	8	18,5	150	520
405	ML5045	U	C1	8	18,5	160	550
405	ML5449	U	U	8	18,5	160	620
406	ML6140	S1	U	8	18,5	160	335
408	ML5926	U	C1	8	18,5	152	265
408	ML5316	U	U	8	18,5	150	310
408	ML5925	U	C1	8	18,5	152	390
410	ML5422	10	10	6	15	166	280
410	ML5936	P	U	8	18,5	155	390
412	ML5241	U	U	8	18,5	155	340
412	ML5691	S1	U	8	18,5	163	400
414	ML6084	T1	T1	8	18,5	160	410
414	ML5868	U	P	8	18,5	150	430
414	ML5911	T1	T1	10	22	155	500
415	ML5801	U	U	8	18,5	160	530
416	ML6184	9	43	8	19	158	395
417	ML5212	U	U	8	18,5	155	500
418	ML5802	U	U	8	18,5	163	490
418	ML5426	U	U	10	22	148	700
418,5	ML5977	S1	S1	8	18,5	155	390
419	ML5625	Y1	U	8	18,5	165	360
419	ML5845	U	U	8	18,5	165	510

Ext. L	Monroe®	↺	↻	Ød	ØD	S	F1
420	ML6215	S1	S3	8	18,5	135	570
420	ML5682	U	U	8	18,5	162	600
422	ML6197	S1	S3	8	18,5	160	365
424,5	ML5669	U	U	8	18,5	165	450
425	ML5695	S1	U	8	18,5	165	350
427	ML5939	U	U	8	18,5	165	240
429	ML6027	U	13	8	18,5	149	400
429	ML6001	Q	Q	10	22	136	838
430	ML5777	U	U	8	18,5	170	370
430	ML5500	S1	S1	8	18,5	160	470
430,5	ML5944	P	P	10	22	130	1050
431	ML6046	U	U	8	18,5	173	320
431	ML5145	U	C1	8	18,5	173	380
431	ML5981	U	U	8	18,5	100	400
431	ML6071	U	U	8	18,5	160	600
431	ML5630	S1	S1	10	22	121	680
433	ML5507	T1	T1	8	18,5	165	500
434	ML5486	S1	S1	8	18,5	153	585
435	ML5297	U	U	8	18,5	160	100
435	ML5733	S1	S1	6	15	180	105
435	ML6082	S1	S1	8	18,5	175	170
436	ML5676	U	U	8	18,5	175	150
436	ML5992	P	U	8	18,5	154	245
436	ML6324	T1	T1	10	22	160	363
437	ML5775	S1	S1	8	18,5	173	350
437	ML6359	S1	S3	8	18,5	157	525
438	ML5414	S1	S1	8	18,5	170	480
439	ML6335	S1	S3	8	18,5	177	100
439,5	ML6086	U	U	8	18,5	155	410
439,5	ML5653	S1	U	8	18,5	157	550
440	ML5382	U	S1	8	18,5	155	300
440	ML5222	S1	U	8	18,5	171	370
440	ML5599	Y1	X1	6	15	142	380
440	ML6250	S1	S3	8	18,5	150	445
440	ML5131	U	C1	8	18,5	160	450
440	ML5661	U	U	8	18,5	170	470
440	ML5175	U	C1	8	18,5	169	600
440	ML6238	S1	S3	8	18,5	150	705
440	ML6237	S1	S3	8	18,5	150	775
440,5	ML5210	U	U	8	18,5	158	370
441	ML5660	P	U	8	18,5	175	300
441	ML6132	S1	S1	8	19	166	530
441,5	ML5280	U	U	8	18,5	169	460
442	ML6302	S1	S3	6	15	162	160
443,5	ML5900	S1	S1	8	18,5	165	455
445	ML6083	S1	S3	8	18,5	176	90
445	ML6105	S1	S1	6	15	175	110
445	ML6329	S1	S3	8	18,5	180	220
445	ML5183	U	U	8	18,5	172	250
445	ML5079	U	U	8	18,5	180	300
445	ML5151	U	U	8	18,5	162	420
445	ML5779	U	U	8	18,5	160	420
445	ML5699	P	S1	8	18,5	183	550
446	ML5894	U	U	8	18,5	170	490
447	ML5230	S1	S1	6	15	170	130
447	ML5814	U	U	8	18,5	175	300
447	ML5096	U	U	8	18,5	172	500
448	ML5136	U	U	8	18,5	180	310
448	ML5343	U	U	8	18,5	180	590
449	ML5987	U	S1	8	18,5	160	470
449	ML5941	S1	S1	8	18,5	179	520
450	ML5116	U	U	8	18,5	175	160
450	ML5025	U	U	8	18,5	175	260
450	ML5298	U	U	8	18,5	175	260

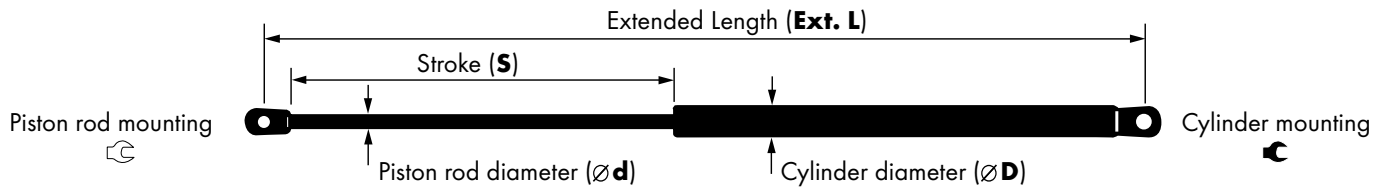

Ext. L	Monroe®	↙	↘	Ød	ØD	S	F1
450	ML5035	U	U	8	18,5	175	280
450	ML5003	U	U	8	18,5	180	300
450	ML5024	U	C1	8	18,5	175	340
450	ML5114	U	U	8	18,5	175	340
450	ML6304	U	U	8	18,5	175	380
450	ML6123	U	U	8	19	181	395
450	ML6205	U	C1	8	18,5	117	400
450	ML6279	U	U	8	18,5	175	430
450	ML5108	U	U	8	18,5	170	460
450	ML5308	U	U	8	18,5	170	490
450	ML5742	S1	U	8	18,5	180	535
450	ML5831	U	S1	8	18,5	180	550
450	ML5121	S1	S1	8	18,5	175	600
450	ML5331	U	K	10	22	162	740
451	ML5725	S1	S1	8	18,5	185	385
451	ML6344	U	C1	8	18,5	162	480
452	ML5480	S1	S1	8	18,5	177	350
452	ML6169	7b	13	8	19	170	660
453	ML6187	7b	44	8	19	185	460
454	ML6236	U	C1	8	18,5	185	330
455	ML6307	P	S3	8	18,5	152	200
455	ML6325	T1	T1	10	22	180	300
455	ML5165	U	U	8	18,5	164	380
455	ML6206	U	C1	8	18,5	160	570
455	ML5415	U	U	10	22	127	700
456	ML6366	P	C1	8	18,5	141	175
456	ML6009	S1	S1	8	18,5	182	185
456	ML5655	S1	U	8	18,5	165	320
457	ML6100	U	U	8	18,5	167	320
458	ML5160	S1	S1	8	18,5	176	430
459	ML5587	S1	S1	8	18,5	172	230
459,5	ML5438	S1	S1	8	18,5	180	535
460	ML5153	S1	S1	8	18,5	169	100
460	ML5028	U	U	8	18,5	170	220
460	ML5097	U	U	8	18,5	170	270
460	ML5270	U	U	8	18,5	160	300
460	ML5785	S1	S1	8	18,5	170	350
460	ML5453	U	U	8	18,5	180	380
460	ML5734	S1	S1	8	18,5	180	440
460,5	ML5867	U	U	8	18,5	174	350
462	ML6346	S1	C1	8	18,5	142	650
462,5	ML5794	T1	T1	8	18,5	190	560
463	ML5796	S1	U	8	18,5	185	360
464	ML5568	S1	S1	8	18,5	166	160
465	ML5492	Y1	D	8	18,5	169	113
465	ML5420	Y1	D	8	18,5	187	320
465	ML5840	I	H	6	15	190	335
465	ML5158	U	U	8	18,5	178	425
465	ML5224	U	K	10	22	140	655
466,5	ML6159	9	43	8	19	172	455
468	ML5485	S1	U	8	18,5	163	440
469	ML6180	9	43	8	19	186	430
469,5	ML5082	U	U	8	18,5	171	560
469,5	ML5656	P	P	8	18,5	185	580
470	ML6243	U	C1	8	18,5	192	245
470	ML5069	U	U	8	18,5	190	350
470	ML5920	U	U	8	18,5	180	350
470	ML5702	P	S1	8	18,5	185	480
470	ML6214	S1	S3	8	18,5	165	510
470	ML5257	U	U	8	18,5	182	600
470	ML5753	U	U	8	18,5	160	630
471	ML5093	S1	S1	8	18,5	191	360
471	ML5427	S1	U	8	18,5	185	380
471	ML6200	S1	S3	8	18,5	200	400

Ext. L	Monroe®	↙	↘	Ød	ØD	S	F1
471	ML5258	U	U	8	18,5	184	570
472	ML5164	U	U	8	18,5	180	330
472	ML6196	S1	S3	8	18,5	200	400
472	ML5413	S1	U	8	18,5	175	590
472,5	ML6336	S1	S3	8	18,5	176	400
473	ML5087	U	C1	8	18,5	172	420
473	ML5032	U	U	8	18,5	188	530
473	ML5757	U	U	8	18,5	182	540
473,5	ML6135	S1	S3	8	18,5	162	535
473,5	ML5383	U	S1	8	18,5	170	590
474	ML5721	U	U	8	18,5	190	570
475	ML5120	U	C1	8	18,5	195	350
475	ML5719	U	P	8	18,5	175	510
475	ML6203	U	C1	8	18,5	150	610
475	ML5773	U	U	8	18,5	195	640
475	ML5746	U	P	8	18,5	184	650
476	ML6367	U	P	8	18,5	176	530
476,5	ML5254	U	U	8	18,5	184	420
477	ML6181	28	9	8	19	191	100
477	ML5462	S1	S1	8	18,5	188	360
477	ML6178	7b	44	8	19	176	650
479	ML5805	P	U	8	18,5	179	340
479	ML6016	U	S3	8	18,5	174	580
480	ML5700	U	U	8	18,5	173	135
480	ML5339	S1	U	8	18,5	180	300
480	ML5708	U	U	8	18,5	195	335
480	ML5703	P	U	8	18,5	190	420
480	ML5871	S1	S1	8	18,5	185	480
480	ML5792	U	P	8	18,5	200	550
480	ML6119	U	C1	8	18,5	189	600
480	ML5512	U	U	10	22	173	690
481	ML5907	S1	S3	8	18,5	183	360
481,5	ML5416	U	U	8	18,5	199	530
482	ML5817	P	U	10	22	185,5	700
482	ML6179	13	25	10	22	155	700
482,5	ML6073	U	U	8	18,5	195	705
483	ML5759	T1	T1	8	18,5	191	370
483	ML6320	U	C1	8	18,5	175/197	440
483	ML5511	U	U	10	22	175	690
483	ML5510	U	U	10	22	175	740
483,5	ML6102	U	P	10	22	148	750
484	ML5650	P	U	8	18,5	190	200
485	ML5739	U	P	8	18,5	200	170
485	ML5159	S1	S1	8	18,5	190	320
485	ML5307	U	U	8	18,5	189	450
485	ML5293	U	U	8	18,5	196	460
485	ML5459	S1	S1	8	18,5	193	460
485	ML5294	U	U	8	18,5	196	520
485	ML5647	P	S1	8	18,5	200	565
485	ML5569	S1	S1	8	18,5	185	580
485	ML5380	U	S1	8	18,5	187	610
485	ML5332	U	U	8	18,5	165	640
485	ML6239	U	C1	8	18,5	165	660
486	ML6229	S1	S3	8	18,5	189	363
486	ML6171	7b	13	8	19	185	500
486	ML5632	Y1	D	8	18,5	170	585
487	ML6183	9	13	8	19	190	645
487,5	ML6235	U	C1	8	18,5	199	320
488	ML6353	S1	S3	8	18,5	190	190
488	ML6129	U	U	8	19	195	510
489	ML6247	U	C1	8	18,5	151	110
489	ML5539	U	U	10	22	144	720
490	ML5180	U	U	8	18,5	190	250
490	ML5570	S1	S1	8	18,5	187	380

EXTENDED LENGTH

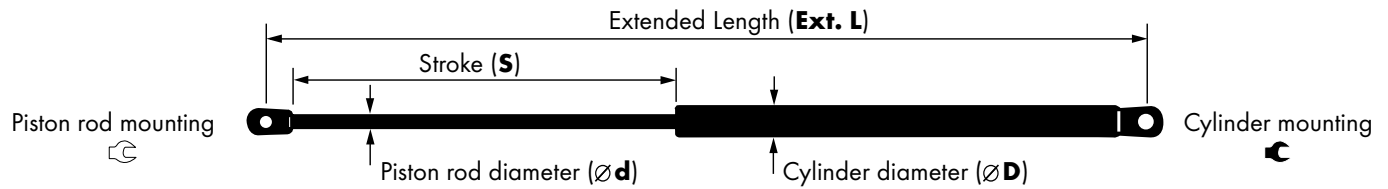

Ext. L	Monroe®	↺	↻	Ød	ØD	S	F1
490	ML5712	P	U	8	18,5	200	380
490	ML5043	Y1	X1	8	18,5	180	480
490	ML5747	T1	T1	8	18,5	198	530
490	ML5979	U	U	8	18,5	189	560
490	ML5495	U	U	8	18,5	195	610
490	ML6188	7b	25	10	22	155	910
490,5	ML5667	U	U	8	18,5	200	480
491	ML5425	U	C1	8	18,5	205	600
492	ML6115	U	C1	8	18,5	175	475
492	ML5557	U	U	10	22	188	710
493	ML5917	S1	S1	8	18,5	195	445
493	ML5217	U	U	8	18,5	196	470
494	ML5995	U	P	8	18,5	194	250
494	ML5460	S1	S1	8	18,5	185	490
494	ML5838	P	P	8	18,5	172	500
495	ML6036	U	U	8	18,5	190	370
495	ML5776	U	P	8	18,5	197	420
495	ML5681	U	U	8	18,5	205	440
495	ML6176	7b	13	8	19	183	460
495	ML6314	S1	S3	8	18,5	202	475
495	ML5080	U	U	8	18,5	192	500
495	ML5218	U	U	8	18,5	198	500
495	ML6087	S1	S1	8	18,5	180,5	510
495	ML5219	U	U	8	18,5	182	515
495	ML5221	U	U	8	18,5	182	565
495	ML5963	S1	S1	8	18,5	180,5	570
495	ML5657	S1	S1	8	18,5	205	610
495	ML6285	S2	S2	10	22	145	830
496	ML5098	P	P	8	18,5	188	270
496	ML6012	P	P	10	22	180	635
496,5	ML5909	I	U	8	18,5	195	340
496,5	ML5253	U	U	8	18,5	192	565
497	ML5717	P	U	8	18,5	200	430
498	ML5406	U	U	8	18,5	197	330
498	ML5592	S1	S1	8	18,5	225	540
498	ML6230	U	P	8	18,5	207	550
498	ML5929	P	P	10	22	191	630
499	ML6043	U	U	8	18,5	145	150
499	ML5371	U	U	8	18,5	195	400
499	ML5677	Y1	T1	8	18,5	205	460
499	ML6289	U	C1	8	18,5	206	540
500	ML5825	S1	S1	8	18,5	230	135
500	ML5287	S1	U	8	18,5	200	190
500	ML5572	Y1	U	8	18,5	190	220
500	ML5306	U	U	8	18,5	196	225
500	ML5600	Y1	D	8	18,5	200	230
500	ML5821	S1	U	8	18,5	203	245
500	ML5574	U	D	8	18,5	200	270
500	ML5038	U	U	8	18,5	200	280
500	ML5195	S1	U	8	18,5	200	280
500	ML5491	S1	U	8	18,5	200	310
500	ML5284	S1	U	8	18,5	200	320
500	ML5767	S1	U	8	18,5	195	340
500	ML5049	U	C1	8	18,5	212	350
500	ML5261	S1	U	8	18,5	200	350
500	ML5264	S1	U	8	18,5	200	350
500	ML5360	U	U	8	18,5	190	360
500	ML5199	S1	U	8	18,5	200	365
500	ML5752	U	U	8	18,5	208	375
500	ML5194	S1	U	8	18,5	200	380
500	ML5115	U	U	8	18,5	200	400
500	ML5196	S1	U	8	18,5	200	400
500	ML5358	U	U	8	18,5	171	400
500	ML5197	S1	U	8	18,5	205	420

Ext. L	Monroe®	↺	↻	Ød	ØD	S	F1
500	ML6190	S1	S3	8	18,5	204	420
500	ML6192	U	C1	8	18,5	184	440
500	ML6341	U	C1	8	18,5	180	440
500	ML5181	S1	U	8	18,5	200	450
500	ML5185	S1	U	8	18,5	205	470
500	ML5198	S1	U	8	18,5	193	470
500	ML5225	S1	U	8	18,5	200	470
500	ML5100	S1	S1	8	18,5	204	480
500	ML5094	U	U	8	18,5	204	500
500	ML5857	P	P	8	18,5	190	500
500	ML5774	T1	P	8	18,5	200	525
500	ML6226	U	C1	8	18,5	184	530
500	ML6157	7b	44	8	19	195	560
500	ML5613	Y1	D	8	18,5	201	600
500	ML5856	U	U	8	18,5	190	600
500	ML6038	T1	T1	10	22	175	630
500	ML5110	U	U	8	18,5	170	635
500	ML5238	S1	P	8	18,5	200	635
500	ML5240	P	P	10	22	200	635
500	ML5635	Y1	D	8	18,5	195	650
500	ML6051	U	U	8	18,5	146	660
500	ML5239	P	U	10	22	195	690
501	ML5073	Y1	X1	8	18,5	207	480
501	ML5291	U	U	8	18,5	175	595
501	ML5612	U	U	10	22	175	780
502	ML5547	S1	S1	6	15	200	125
502	ML6283	U	U	8	18,5	200	250
502	ML5072	U	U	8	18,5	200	280
502	ML5101	S1	S1	8	18,5	199	280
502	ML5004	U	U	8	18,5	200	400
502	ML5615	U	P	8	18,5	195	400
502	ML5923	U	U	8	18,5	205	450
502	ML5132	S1	U	8	18,5	205	500
502	ML5227	S1	S1	8	18,5	200	530
502	ML5918	U	U	8	18,5	205	530
503,5	ML6134	S1	S3	8	18,5	187	450
504	ML6232	U	C1	8	18,5	215	355
505	ML6126	S1	S1	8	18,5	210	300
505	ML5731	S1	P	8	18,5	211	330
505	ML5618	N	N	8	18,5	180	430
505	ML5732	S1	S1	8	18,5	195	490
505	ML5256	U	U	8	18,5	190	520
505	ML5997	P	S1	8	18,5	205	585
505	ML5722	U	U	10	22	205	610
505	ML5743	U	P	10	22	170	770
506	ML5461	S1	S1	8	18,5	205	180
506	ML5281	U	U	8	18,5	200	380
506	ML6308	S1	S1	10	22	161	720
506,5	ML6022	U	C1	8	18,5	186	485
506,5	ML6023	U	C1	8	18,5	186	515
507	ML5078	U	U	8	18,5	205	420
507	ML6240	U	C1	8	18,5	175	435
507	ML5362	U	U	8	18,5	208	436
507	ML5377	U	S1	8	18,5	203	520
507	ML5178	U	U	8	18,5	207	550
508	ML5390	U	U	8	18,5	194	350
508	ML5156	P	P	8	18,5	195	550
508	ML5125	U	U	8	18,5	195	600
509	ML5005	U	U	8	18,5	200	420
509,5	ML6164	7b	44	8	19	204	350
510	ML6219	U	C1	8	18,5	205	270
510	ML5361	U	U	8	18,5	200	320
510	ML5146	S1	S1	8	18,5	210	340
510	ML5784	U	U	8	18,5	213	360

EXTENDED LENGTH

Ext. L

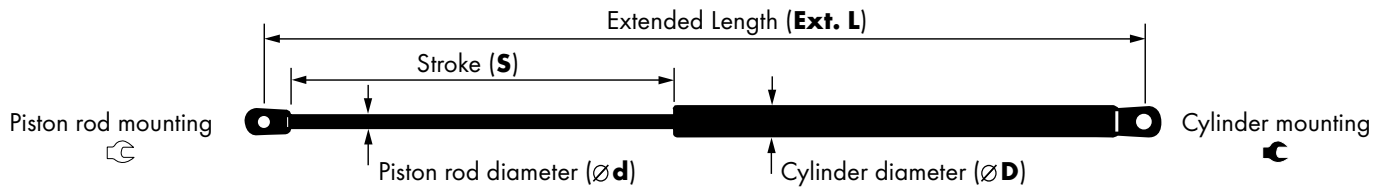

Ext. L	Monroe®	↙	↘	Ød	ØD	S	F1
510	ML5370	U	P	8	18,5	200	370
510	ML5395	U	U	8	18,5	208	390
510	ML5391	U	U	8	18,5	208	470
510	ML5103	U	U	8	18,5	202	620
511	ML5408	U	U	8	18,5	199	520
511,5	ML5641	S1	S1	8	18,5	172	545
512	ML5645	Y1	U	8	18,5	200	300
512	ML6339	S1	S3	8	18,5	200/225	310
512	ML5990	U	U	8	18,5	198	460
512	ML6173	9	9	8	19	200	470
512	ML6318	P	P	8	18,5	212	475
512	ML5985	T1	T1	10	22	200	520
512	ML5168	U	U	8	18,5	200	550
513	ML5359	U	U	8	18,5	215	350
513	ML5189	S1	S1	8	18,5	207	535
513	ML5190	S1	S1	8	18,5	207	585
514	ML5873	U	P	8	18,5	180	335
514,5	ML5106	U	D	8	18,5	217	610
515	ML5890	S1	S1	8	18,5	210	365
515	ML5068	U	U	8	18,5	202	370
515	ML5713	U	U	8	18,5	215	400
515	ML5410	S1	S1	8	18,5	200	445
515	ML5478	S1	S1	8	18,5	200	490
515	ML5622	S1	S1	8	18,5	187	490
515	ML5684	U	U	8	18,5	190	490
515	ML5711	U	U	8	18,5	210	490
515	ML5123	S1	S1	8	18,5	210	500
515	ML5124	U	U	8	18,5	195	500
515	ML5177	U	U	8	18,5	210	550
515	ML5644	T1	D	8	18,5	215	550
515	ML5760	P	U	8	18,5	196	585
515	ML6153	7b	44	8	19	210	600
515,5	ML6013	S1	S1	10	22	205	610
516	ML6008	S1	S1	8	18,5	184	160
516	ML5405	U	U	8	18,5	205	425
516	ML6340	S1	S3	8	18,5	187	560
516,5	ML5872	S1	S1	8	18,5	150	580
517	ML5436	S1	S1	8	18,5	190	420
517	ML5214	S1	S1	8	18,5	200	460
517,5	ML6151	S1	C1	8	18,5	191	295
518	ML5036	Y1	X1	8	18,5	209	220
519	ML5864	U	U	8	18,5	184	370
519	ML6220	S1	C1	8	18,5	185	530
520	ML5812	U	U	8	18,5	208	130
520	ML5056	Y1	X1	8	18,5	213	230
520	ML6348	S1	S3	8	18,5	205	300
520	ML5296	U	U	8	18,5	197	435
520	ML6172	7b	13	8	19	198	540
520	ML5826	U	C1	8	18,5	180	625
520	ML5475	U	U	8	18,5	175	640
520	ML6331	U	U	10	22	180	660
520	ML5433	U	U	10	22	180	665
520	ML5580	U	U	10	22	185	730
522	ML5271	U	U	8	18,5	210	300
522	ML5272	U	U	8	18,5	210	400
522	ML6130	P	U	8	19	210	490
523	ML5579	S1	S1	8	18,5	202	530
523	ML6128	S1	S1	8	19	200	600
524	ML5983	U	P	10	22	212	540
524	ML5984	U	P	10	22	212	585
525	ML5340	U	U	8	18,5	210	140
525	ML6328	U	C1	8	18,5	220	150
525	ML5350	U	U	8	18,5	210	240
525	ML5636	U	U	8	18,5	210	240

Ext. L	Monroe®	↙	↘	Ød	ØD	S	F1
525	ML5560	U	13	8	18,5	200	280
525	ML5347	U	U	8	18,5	205	310
525	ML5348	U	U	8	18,5	205	350
525	ML5349	U	U	8	18,5	210	480
526	ML5140	U	U	8	18,5	206	320
526	ML5849	U	U	8	18,5	220	325
526	ML6316	P	P	8	18,5	207	555
526	ML5313	U	U	8	18,5	206	560
526	ML5086	S1	S1	8	18,5	207	570
526,5	ML5961	S1	S3	8	18,5	208	125
527	ML5211	U	U	8	18,5	210	350
527	ML5300	U	U	8	18,5	202	390
527	ML6210	U	P	8	18,5	218	390
527	ML5048	U	U	8	18,5	219	420
527	ML5044	U	U	8	18,5	219	450
527	ML5061	U	C1	8	18,5	210	450
527	ML5169	U	U	8	18,5	206	450
527	ML5064	U	U	8	18,5	219	520
527	ML6117	U	C1	8	18,5	163	535
527	ML6116	U	C1	8	18,5	163	610
527	ML5889	S1	S1	8	18,5	188	620
527	ML5581	U	U	10	22	200	660
528	ML5026	U	U	8	18,5	224	160
528	ML5099	U	U	8	18,5	224	220
528	ML5754	U	P	8	18,5	212	420
529	ML5276	U	U	8	18,5	215	245
530	ML5548	S1	S1	6	15	213	110
530	ML5749	U	P	8	18,5	210	410
530	ML6363	S1	P	8	18,5	218	425
530	ML5690	S1	S1	8	18,5	175	530
531	ML5666	U	U	8	18,5	173	545
532	ML6313	P	13	8	18,5	217	355
532,5	ML5895	U	U	8	18,5	190	360
533	ML6024	P	13	8	18,5	216	330
533	ML6315	S1	S3	8	18,5	195	460
533	ML5724	S1	S1	8	18,5	200	515
533	ML6075	U	K	10	22	220	750
534	ML5509	T1	T1	8	18,5	217	200
534	ML5161	U	U	8	18,5	216	410
534,5	ML5440	S1	S1	8	18,5	220	480
535	ML6352	S1	S3	8	18,5	210	380
535	ML5474	S1	S1	8	18,5	220	425
535	ML6233	U	C1	8	18,5	194	455
535	ML5167	U	U	8	18,5	215	480
535	ML5231	U	U	8	18,5	198	485
535	ML5232	U	U	8	18,5	198	520
535	ML5233	U	U	8	18,5	198	585
535	ML5781	U	S1	10	22	183	710
536	ML5809	S1	S1	8	18,5	204	410
536	ML6155	7b	44	8	19	225	540
536,5	ML5166	U	C1	8	18,5	205	430
537	ML6167	7b	44	8	19	180	670
537	ML6058	S1	S1	10	22	198	750
538	ML5357	U	U	8	18,5	190	125
538	ML6005	S1	S1	8	18,5	220	510
538	ML6080	U	U	8	18,5	205	650
539	ML5772	T1	P	8	18,5	218	585
539	ML6113	Q	Q	10	22	163	690
540	ML5447	T1	T1	8	18,5	130	170
540	ML5327	U	U	8	18,5	220	250
540	ML5672	U	U	8	18,5	210	385
540	ML5763	T1	T1	8	18,5	225	390
540	ML5188	U	U	8	18,5	214	400
540	ML6322	U	C1	8	18,5	182	420

EXTENDED LENGTH

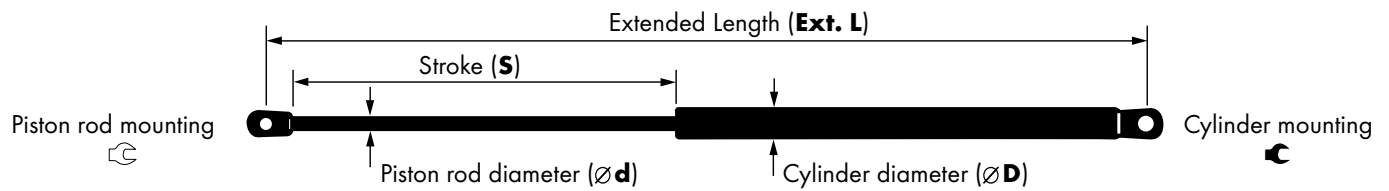

Ext. L	Monroe®	↺	↻	Ød	ØD	S	F1
540	ML5157	U	U	10	22	200	450
540	ML5213	S1	S1	8	18,5	200	450
540	ML5506	T1	T1	8	18,5	220	490
540	ML5119	U	U	8	18,5	196	540
542	ML5041	U	U	8	18,5	210	300
542	ML5137	U	U	8	18,5	193	590
542	ML6216	S1	K	10	22	175	740
543	ML5954	U	U	8	18,5	220	200
543	ML5720	U	U	8	18,5	220	310
543,5	ML5242	U	U	8	18,5	206	320
543,5	ML5054	U	U	8	18,5	206	360
543,5	ML6291	U	C1	8	18,5	217	460
544	ML5607	S1	S1	8	18,5	224	250
544	ML5651	P	U	8	18,5	218	290
544	ML5252	U	U	8	18,5	210	440
544	ML5109	U	U	8	18,5	207	495
545	ML5312	U	U	8	18,5	230	300
545	ML5668	S1	U	8	18,5	195	425
545	ML5692	U	U	8	18,5	210	450
545	ML5378	U	S1	8	18,5	210	490
545	ML5314	U	U	8	18,5	220	530
545	ML5379	U	S1	8	18,5	210	530
545	ML5707	U	U	8	18,5	210	620
545	ML5591	U	Q	10	22	195	750
546	ML5457	U	U	8	18,5	225	220
546	ML5372	U	U	8	18,5	215	500
547	ML5551	S1	S1	6	15	190	170
547	ML5556	Y1	X1	6	15	214	225
547	ML5597	U	X1	8	18,5	230	230
547	ML5718	U	U	10	22	220	460
547	ML6143	U	U	8	18,5	222	535
547	ML5828	U	P	8	18,5	220	550
548	ML5862	S1	S1	8	19	220	420
548	ML5373	U	U	8	18,5	213	475
548	ML6327	U	C1	8	18,5	193	520
549	ML5016	Y1	X2	8	18,5	229,5	240
549	ML6040	U	U	8	18,5	219	290
549	ML5243	U	U	8	18,5	232	320
549	ML5015	Y1	X1	8	18,5	229,5	350
549	ML5031	U	U	8	18,5	222	355
549	ML5244	U	U	8	18,5	232	410
549,5	ML5055	Y1	X1	8	18,5	229,5	160
549,5	ML5334	U	U	8	18,5	200	610
550	ML5006	Y2	X2	8	18,5	212	230
550	ML6246	U	C1	8	18,5	235	260
550	ML5780	T1	T1	8	18,5	235	280
550	ML5292	U	U	8	18,5	220	285
550	ML5039	Y1	X2	8	18,5	229,5	380
550	ML5642	T1	T1	8	18,5	200	460
550	ML5571	T1	T1	8	18,5	222	475
550	ML5787	T1	T1	10	22	160	710
550	ML6213	U	C1	8	18,5	173	715
550	ML5429	U	U	10	22	235	810
550	ML5076	U	U	10	22	235	850
552	ML6217	U	C1	8	18,5	216	295
552	ML5208	U	U	8	18,5	205	370
552	ML5209	U	U	8	18,5	200	410
552	ML5176	S1	U	8	18,5	200	560
553	ML5659	S1	S1	8	18,5	225	220
554	ML5788	T1	T1	8	18,5	185	200
554	ML5126	S1	U	8	18,5	200	515
554	ML6202	U	C1	8	18,5	239	550
554	ML6277	U	C1	8	18,5	200	670
555	ML5687	U	U	8	18,5	228	305

Ext. L	Monroe®	↺	↻	Ød	ØD	S	F1
555	ML5353	U	U	8	18,5	220	450
555	ML5173	U	U	8	18,5	228	485
555	ML6306	U	P	10	22	202	585
556	ML6319	U	C1	8	18,5	235	240
556	ML5374	U	U	8	18,5	225	475
556	ML5289	U	U	8	18,5	205	500
556	ML5797	T1	T1	10	22	224	715
556,5	ML6290	U	K	8	18,5	224	450
557	ML5171	U	U	8	18,5	224	360
557	ML5172	U	U	8	18,5	224	425
557	ML5381	U	S1	8	18,5	215	550
557	ML5991	U	U	8	18,5	220	580
558	ML5493	S1	S1	8	18,5	200	135
558	ML6276	U	13	8	18,5	216	470
558	ML5782	T1	T1	8	18,5	235	500
558	ML5824	S1	S1	8	18,5	235	530
558	ML5319	U	U	8	18,5	200	550
559	ML5850	S1	P	8	18,5	230	290
559	ML5588	S1	S1	8	18,5	220	330
560	ML6330	U	15	8	18,5	190	590
560	ML5806	U	P	10	22	178	725
560	ML5228	U	K	10	22	210	730
560	ML5229	U	U	10	22	210	800
561	ML6223	U	C1	8	18,5	215	445
563	ML5956	S1	S3	8	18,5	235	140
563	ML5577	U	13	8	18,5	200	280
565	ML5973	S1	S1	8	18,5	200	200
565	ML5705	S1	U	8	18,5	240	290
565	ML5730	U	U	8	18,5	215	315
565	ML5144	U	U	8	18,5	216	360
565	ML6303	U	C1	8	18,5	210/250	360
565	ML5388	U	U	8	18,5	215	480
565	ML5765	T1	T1	8	18,5	220	500
565	ML5412	S1	U	8	18,5	210	560
565	ML6224	O	O	8	18,5	165	600
566	ML5202	U	U	8	18,5	230	440
566	ML5138	U	U	8	18,5	204	500
567	ML5248	U	U	10	22	225	460
567	ML6109	U	U	8	19	228	460
567	ML5424	U	S1	8	18,5	193	540
567	ML5912	S1	U	8	18,5	195	550
567	ML5141	U	U	10	22	221	590
567	ML5142	U	U	10	22	221	650
567,5	ML5367	U	U	8	18,5	183	430
568	ML5819	U	U	8	18,5	233	330
568	ML6312	P	13	8	18,5	254	355
568	ML5396	U	U	8	18,5	213	360
568	ML5541	S1	S1	8	18,5	215	410
568	ML5375	U	U	8	18,5	230	500
568	ML5397	U	U	8	18,5	230	560
569	ML5081	U	C1	8	18,5	242	210
569	ML5040	U	U	8	18,5	220	280
569	ML5869	U	P	8	18,5	240	310
569	ML5246	U	U	10	22	240	660
569	ML5893	S1	S1	8	18,5	240	670
569	ML5245	U	U	10	22	240	750
569	ML5247	U	U	10	22	240	830
569	ML5105	U	U	10	22	240	910
569,5	ML6002	U	U	10	22	155	590
570	ML5399	U	U	8	18,5	230	215
570	ML6025	P	13	8	18,5	254	330
570	ML5400	U	U	8	18,5	230	420
570	ML5288	U	U	8	18,5	230	460
570	ML5402	U	U	8	18,5	240	470

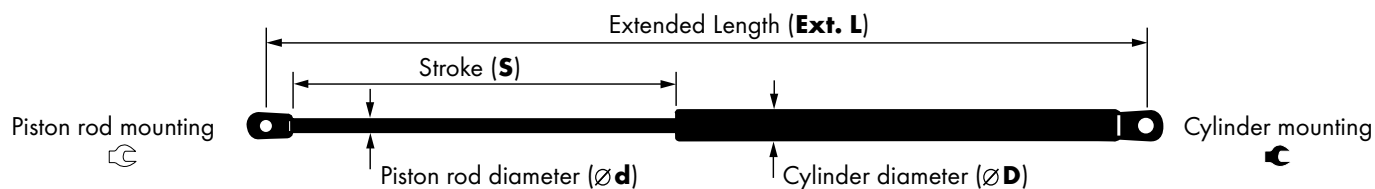

Ext. L	Monroe®	↺	↻	∅d	∅D	S	F1
570	ML5354	U	U	8	18,5	230	490
570	ML5122	U	U	8	18,5	232	520
570	ML5278	U	U	8	18,5	240	520
570	ML5401	U	U	8	18,5	230	520
570	ML5338	U	U	8	18,5	215	530
570	ML5616	S1	U	8	18,5	200	630
570	ML5816	T1	T1	10	22	240	650
571	ML5346	U	U	8	18,5	208	570
573,5	ML5554	U	T1	10	22	215	580
573,5	ML5555	U	T1	10	22	215	670
574	ML5143	U	U	8	18,5	235	260
574	ML5147	U	U	8	18,5	235	310
574	ML5771	P	P	10	22	198	990
574,5	ML5476	S1	S1	8	18,5	230	530
574,5	ML5477	S1	S1	8	18,5	230	620
575	ML5342	U	U	8	18,5	235	330
575	ML5482	S1	S1	8	18,5	230	440
575	ML5437	S1	U	8	18,5	220	500
577	ML5564	U	P	8	18,5	225	270
577	ML5463	S1	S1	8	18,5	226	275
577	ML5464	S1	S1	8	18,5	226	320
577	ML5201	U	U	8	18,5	226	400
577	ML5200	U	U	8	18,5	226	415
577	ML5986	S1	C1	8	18,5	190	530
579	ML5606	Y1	D	8	18,5	235	320
579	ML6199	S1	S3	8	18,5	248	330
580	ML5822	S1	S1	8	18,5	245	165
580	ML5620	U	U	8	18,5	205	230
580	ML5398	U	U	8	18,5	245	340
580	ML5609	W	D	8	18,5	245	380
580	ML5428	S1	S1	8	18,5	247	470
580	ML5683	P	U	8	18,5	201	510
580	ML6194	U	C1	8	18,5	179	550
580	ML6042	S1	S1	8	18,5	200	560
581,5	ML5469	S1	S1	8	18,5	210	535
582	ML5673	U	U	8	18,5	203	460
584	ML6060	S1	S1	8	18,5	250	150
584	ML5014	U	U	8	18,5	234	280
584	ML5066	U	U	8	18,5	234	290
584	ML6357	P	C1	8	18,5	194	600
585	ML5034	Y1	X1	8	18,5	250	200
585	ML5265	U	U	8	18,5	235	250
585	ML6069	U	P	8	18,5	246	260
585	ML5134	U	U	8	18,5	222	280
585	ML5842	S2	15	8	18,5	235	310
585	ML5843	S2	16	8	18,5	235	310
585	ML5191	U	U	8	18,5	235	360
585	ML5664	U	U	8	18,5	240	420
585	ML6070	U	C1	8	18,5	250	430
585	ML5940	S1	S1	8	18,5	246	500
585	ML6337	S2	15	8	18,5	235	500
585	ML6338	S2	16	8	18,5	235	500
585	ML5783	U	P	8	18,5	190	625
585,5	ML5665	U	U	8	18,5	245	405
585,5	ML6332	U	U	8	18,5	245	460
585,5	ML5888	T1	T1	8	18,5	235	510
587	ML6085	11	11	8	18,5	235	100
587,5	ML6144	S1	C1	8	18,5	167,5	590
588	ML6311	U	13	8	18,5	234	300
588	ML6198	S1	S3	8	18,5	210	360
588	ML6122	P	P	8	19	204	400
588	ML5958	U	P	8	18,5	198	645
589	ML5959	S1	S1	8	18,5	240	110
589	ML6321	U	P	8	18,5	170	540

Ext. L	Monroe®	↺	↻	∅d	∅D	S	F1
590	ML5317	U	U	8	18,5	215	410
590	ML5701	S1	U	8	18,5	176	435
590	ML5318	U	U	8	18,5	215	450
590	ML5662	U	U	8	18,5	245	460
590	ML5324	U	U	8	18,5	220	480
590	ML6124	U	P	8	19	225	590
590,5	ML5430	U	U	8	18,5	245	480
591	ML5077	U	C1	8	18,5	240	350
591	ML5286	U	U	8	18,5	239	400
591	ML5127	U	U	10	22	200	830
595	ML5013	U	U	8	18,5	235	280
595	ML5285	U	U	8	18,5	248	370
595	ML5262	U	U	8	18,5	250	450
595	ML5279	S1	U	8	18,5	210	470
595	ML5152	U	C1	8	18,5	250	485
595	ML5989	U	K	10	22	205	680
596	ML5235	U	U	8	18,5	190	380
596	ML5237	U	U	8	18,5	190	420
596	ML5236	U	U	8	18,5	195	430
596	ML5544	U	S1	8	18,5	210	450
596	ML5545	U	S1	8	18,5	210	510
596,5	ML5130	U	C1	8	18,5	212	515
598,5	ML6057	U	C1	10	22	186	700
599	ML5434	U	U	8	18,5	220	360
599	ML5206	U	U	8	18,5	190	425
600	ML5598	S1	S1	8	18,5	250	160
600	ML5009	Y1	X1	8	18,5	255	180
600	ML5010	Y1	X1	8	18,5	255	200
600	ML5133	U	U	8	18,5	250	250
600	ML5020	U	U	8	18,5	230	290
600	ML5148	U	U	8	18,5	230	300
600	ML5042	Y1	X1	8	18,5	255	310
600	ML5255	U	U	8	18,5	250	320
600	ML6041	T1	T1	10	22	220	325
600	ML5325	U	U	8	18,5	244	330
600	ML6273	U	U	8	18,5	250	340
600	ML5011	Y1	X1	8	18,5	255	360
600	ML5394	U	U	8	18,5	226	360
600	ML5815	U	U	8	18,5	228	360
600	ML6166	7b	44	8	19	239	385
600	ML6358	P	C1	8	18,5	240	425
600	ML5065	U	U	8	18,5	245	430
600	ML6278	U	U	8	18,5	250	430
600	ML5207	U	U	8	18,5	190	440
600	ML5067	Y1	X1	8	18,5	255	450
600	ML5320	U	U	8	18,5	225	450
600	ML5019	Y1	X1	8	18,5	250	500
600	ML5503	T1	T1	8	18,5	215	510
600	ML5504	T1	T1	8	18,5	215	550
600	ML5501	Y2	D	8	18,5	250	540
600	ML6218	U	C1	8	18,5	195	580
600	ML5968	U	U	8	18,5	225	670
600,5	ML5184	S1	P	8	18,5	223	320
602	ML5139	S1	S1	8	18,5	250	160
602	ML6362	P	P	8	18,5	241	270
602	ML5107	U	U	8	18,5	252	430
602	ML5299	U	U	8	18,5	252	430
603	ML5827	U	U	8	18,5	255	240
603	ML5443	U	U	10	22	220	740
603	ML5537	U	U	10	22	198	810
603	ML5538	U	U	10	22	198	850
604	ML5697	U	U	8	18,5	253	250
604	ML6017	U	U	8	18,5	225	510
605	ML6295	S1	P	8	18,5	240	325

EXTENDED LENGTH

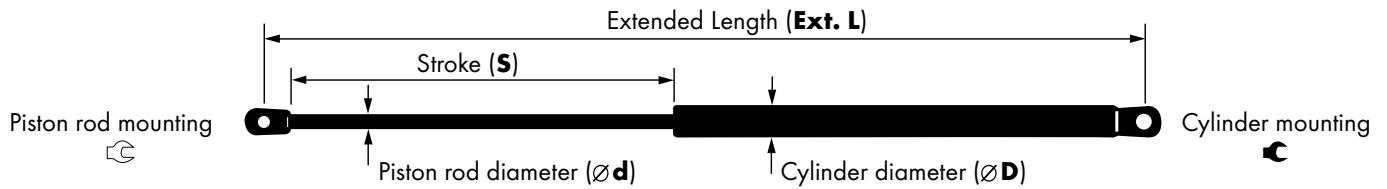

Ext. L	Monroe®			$\varnothing d$	$\varnothing D$	S	F1
605	ML5534	S1	U	8	18,5	247	340
605	ML5770	P	P	8	18,5	242	655
606,5	ML5384	U	S1	8	18,5	230	540
609,5	ML5807	U	U	8	18,5	251,5	245
610	ML6361	P	P	8	18,5	252	275
610	ML6310	U	I3	8	18,5	234	300
610	ML5847	B2	A2	10	22	240	500
610	ML5848	B1	A1	10	22	240	500
610	ML5305	U	U	8	18,5	200	560
610	ML5627	U	U	8	18,5	200	560
610	ML5456	U	U	8	18,5	200	600
611	ML5149	U	U	8	18,5	230	355
611	ML6089	T1	T1	8	18,5	228	420
611	ML6296	S1	S3	8	18,5	282	480
613	ML5820	U	U	8	18,5	260	300
613,5	ML5585	O	O	10	22	248	560
613,5	ML5527	O	O	10	22	248	620
613,5	ML5586	O	O	10	22	248	640
613,8	ML5091	E4	T1	8	18,5	248	190
613,8	ML5092	E4	T1	8	18,5	248	190
614	ML5465	S1	S1	8	18,5	229	300
614	ML5023	U	U	8	18,5	230	330
615	ML5919	Y1	D	8	18,5	243	240
615	ML6364	P	C1	8	18,5	162/230	265
615	ML5593	Y1	D	8	18,5	260	400
620	ML5948	U	S1	10	22	225	625
622	ML5129	S1	S1	8	18,5	240	360
624	ML5432	S1	S1	8	18,5	260	400
625	ML5866	U	P	10	22	210	510
625	ML5205	U	U	8	18,5	253	575
625	ML5693	P	S1	8	18,5	210	590
627	ML5283	U	U	8	18,5	230	570
627	ML5626	U	U	8	18,5	230	570
627	ML5454	U	U	8	18,5	230	630
627	ML5671	U	U	8	18,5	205	660
628	ML5795	U	U	8	18,5	272	440
630	ML5282	U	U	8	18,5	269	330
630	ML6207	U	C1	8	18,5	186	480
630	ML5505	T1	T1	8	18,5	220	570
631	ML5458	U	U	8	18,5	230	440
631	ML5851	S1	S1	8	18,5	265	455
632	ML6345	T1	T1	8	18,5	232	280
632	ML5344	U	U	8	18,5	230	510
632	ML5363	U	U	8	18,5	215	600
632	ML5455	U	U	8	18,5	215	600
632,5	ML6241	S1	S3	8	18,5	216	550
635	ML5567	S1	S1	8	18,5	225	200
635	ML5450	U	U	8	18,5	259	290
635	ML5364	U	U	8	18,5	248	360
639	ML5836	T1	T1	8	18,5	258	465
640	ML5573	U	D	8	18,5	235	390
640	ML5311	U	U	8	18,5	190	470
640	ML5530	U	P	8	18,5	260	510
640	ML5756	U	P	8	18,5	255	565
640	ML5755	U	P	8	18,5	255	595
640	ML6234	U	K	10	22	240	740
643	ML6044	S1	S1	8	18,5	204	475
644	ML6003	U	P	8	18,5	265	300
645	ML5088	E2	E3	8	18,5	202,6	470
645	ML5089	E2	E3	8	18,5	202,6	470
645,5	ML5418	U	U	8	18,5	275	450
647	ML6294	P	C1	8	18,5	259	275
648	ML5267	S1	S1	8	18,5	265	190
648	ML6211	S1	S3	8	18,5	270	260

Ext. L	Monroe®			$\varnothing d$	$\varnothing D$	S	F1
650	ML5345	U	U	8	18,5	270	310
650	ML5603	Y1	D	8	18,5	275	310
650	ML5605	S1	D	8	18,5	275	310
650	ML5715	U	C1	8	18,5	270	350
650	ML5578	U	U	8	18,5	250	460
650	ML6297	U	U	10	22	260	690
650	ML6298	U	U	10	22	260	745
652	ML6162	7b	44	8	19	240	610
652	ML6053	U	C1	8	18,5	218	750
653	ML5452	U	U	8	18,5	260	460
655	ML6209	U	U	10	22	195/260	770
656	ML5435	S1	S1	8	18,5	260	400
656	ML6195	U	U	10	22	186	880
657	ML5654	U	U	8	18,5	275	480
657	ML6354	U	U	10	22	200	540
660	ML6288	U	C1	8	18,5	276	500
661,5	ML6055	U	U	10	22	260,5	800
662	ML6342	P	C1	8	18,5	280	350
663,5	ML6074	U	Q	8	18,5	271	315
664	ML6072	U	U	8	18,5	275	265
665	ML5521	T1	Q	8	18,5	270	360
665	ML6125	S1	S1	8	19	238	535
665	ML5947	P	P	10	22	195	765
666,5	ML5162	S1	S1	8	18,5	275	390
667	ML5542	U	U	8	18,5	215	375
667	ML5716	U	U	10	22	255	755
668	ML5333	Y1	D	8	18,5	280	375
668	ML5403	U	U	8	18,5	215	375
669	ML6138	U	U	8	18,5	186	200
671,5	ML5589	S1	S1	8	18,5	270	360
672	ML5938	S1	U	8	18,5	240	180
673	ML5976	N	N	8	18,5	276	250
674	ML5798	U	U	8	18,5	293	300
674	ML5799	U	U	8	18,5	293	330
675	ML5608	N	N	8	18,5	279	210
675	ML5309	U	U	8	18,5	285	260
675	ML5315	U	U	8	18,5	275	440
677	ML5631	T1	T1	8	18,5	274	340
678	ML5393	U	U	8	18,5	270	270
678	ML5295	U	U	8	18,5	282	480
680	ML5192	U	U	8	18,5	270	360
680	ML5634	T1	T1	8	18,5	270	360
680	ML5508	T1	T1	8	18,5	270	390
681	ML6343	P	C1	8	18,5	280	320
684	ML6305	U	C1	8	18,5	209	505
685	ML5268	U	U	8	18,5	285	180
685	ML5470	S1	S1	8	18,5	265	200
685	ML5249	P	P	10	22	250	710
685	ML5118	P	P	10	22	250	770
685	ML5251	P	P	10	22	250	830
685	ML5250	P	P	10	22	250	910
686	ML6231	U	U	8	18,5	295	700
687	ML5561	U	U	8	18,5	295	270
687	ML6165	7b	44	8	19	208	555
690	ML6096	P	U	8	18,5	280	380
690	ML5128	S1	S1	10	22	280	630
690	ML5837	T1	T1	8	18,5	300	630
691,5	ML5337	U	U	8	18,5	285	270
693	ML6368	P	C1	8	18,5	304	145
694	ML6111	S1	C1	8	18,5	294	220
695	ML5543	U	U	8	18,5	272	640
696	ML5022	Y1	X1	8	18,5	278	220
697	ML5528	M	O	10	22	257	610
697	ML6356	U	U	10	22	200	650

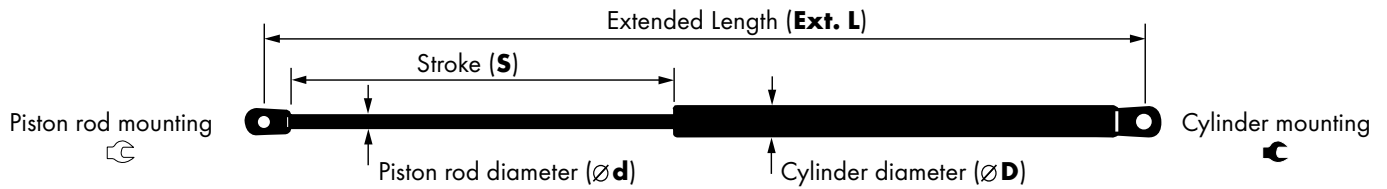

Ext. L	Monroe®	↺	↻	Ød	ØD	S	F1
699	ML5835	M	O	10	22	257	540
699	ML5834	M	O	10	22	257	610
700	ML5021	U	U	8	18,5	251	200
700	ML5407	U	U	8	18,5	257	320
700	ML5037	U	P	8	18,5	300	325
700	ML5057	P	S1	8	18,5	300	325
700	ML5499	Y1	D	8	18,5	295	345
700	ML5494	Y1	D	8	18,5	295	400
700	ML5113	T1	T1	8	18,5	300	670
700	ML5950	U	U	10	22	172	1050
703	ML6168	13	44	8	19	282	530
715	ML5565	P	S1	8	18,5	303	160
715	ML5269	P	U	8	18,5	306	290
720	ML5737	P	U	8	18,5	300	180
720	ML5750	U	U	10	22	280	870
721,5	ML6049	U	U	8	18,5	313	180
721,5	ML5768	U	U	8	18,5	315	350
722	ML5266	U	C1	8	18,5	306	280
722	ML5679	L	L	8	18,5	306	310
722	ML5386	U	U	8	18,5	315	325
722	ML5515	U	U	10	22	210	819
724	ML6365	P	C1	8	18,5	286	340
726	ML5051	S1	E1	10	22	280	420
726,5	ML5758	P	U	8	18,5	310	360
728	ML5648	P	U	8	18,5	310	265
728	ML6079	P	U	8	18,5	310	315
730	ML5726	U	U	8	18,5	316	140
730	ML6254	P	C1	8	18,5	315	210
730	ML5735	P	U	8	18,5	320	250
730	ML5829	P	U	8	18,5	310	380
730	ML5518	U	U	10	22	200	700
730	ML5519	U	U	10	22	200	760
734	ML6185	13	44	8	19	322	320
735	ML5738	P	U	8	18,5	321	300
736	ML6323	S1	S3	8	18,5	326	315
736,5	ML5709	U	U	10	22	310	725
739	ML6300	U	U	10	22	202	700
739	ML6301	U	U	10	22	202	850
740	ML5790	P	S1	8	18,5	310	290
740,5	ML6156	13	44	8	19	280	210
742	ML6039	T1	T1	10	22	277	400
743	ML6287	U	K	10	22	237	670
746	ML6284	P	C1	8	18,5	291	200
750	ML5368	S1	S1	8	18,5	315	300
755	ML5575	U	P	10	22	210	970
755	ML5576	U	U	10	22	210	1080
755	ML5833	U	P	10	22	210	1080
759	ML6299	U	U	10	22	256	670
765	ML5638	U	U	8	18,5	324	200
765	ML5409	U	U	8	18,5	325	235
765	ML5741	U	U	8	18,5	335	340
769	ML5582	U	U	10	22	247	475
772	ML5329	U	U	10	22	322	630
775	ML5328	U	U	10	22	322	530
775	ML5621	U	U	10	22	322	530
779	ML6221	P	C1	8	18,5	360	285
788	ML5102	Y1	V	8	18,5	342	280
796,5	ML6201	U	K	10	22	246,5	720
798	ML5074	F1	Y3	10	22	350	500
810	ML6309	U	C1	8	18,5	350	280
828	ML5369	U	U	8	18,5	249	355
830	ML5892	S1	S1	8	18,5	300	560
850	ML5514	U	U	10	22	340	670
866	ML5448	U	U	10	22	350	370

Ext. L	Monroe®	↺	↻	Ød	ØD	S	F1
870	ML5584	S1	U	10	22	370	370
874	ML6032	U	13	10	22	404	260
885	ML5385	U	X1	10	22	380	410
905	ML5516	T1	T1	10	22	307	730
905	ML5550	T1	T1	10	22	307	730
943	ML5678	U	L	10	22	417	380

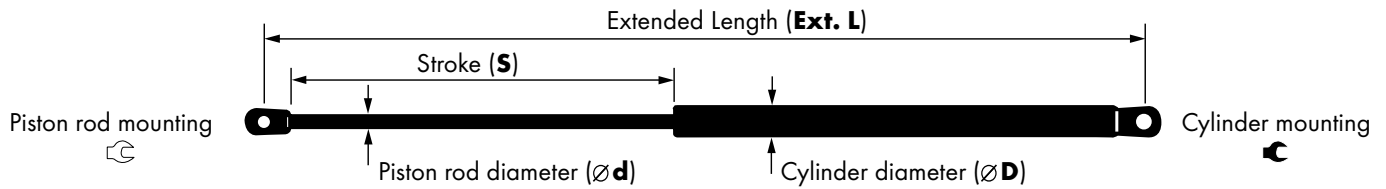

S	Monroe®	↺	↻	Ød	ØD	Ext. L	F1
36	ML6067	S1	S1	8	18,5	195,5	500
40	ML5974	T1	T1	6	15	155	400
40	ML5686	U	U	8	18,5	165	650
45	ML5675	U	U	10	22	175	700
48	ML5389	S1	S1	8	18,5	215	420
50	ML5583	U	U	10	22	195	760
52	ML5791	S1	U	8	18,5	201	250
52	ML5559	U	S2	10	22	235	850
55	ML5526	S1	14	8	18,5	178	480
55	ML5546	R	R	6	15	185	100
55	ML5517	U	U	10	22	195	1100
57	ML6068	U	C1	8	18,5	227	790
58	ML5808	S1	S1	8	18,5	256	560
60	ML6066	S1	S1	6	15	195,5	350
60	ML5978	S1	S1	8	18,5	201	450
60	ML6147	S1	S1	8	18,5	225	560
60	ML6292	S1	S3	8	18,5	234	600
60	ML6326	U	C1	8	18,5	346,5	400
62	ML5860	S1	S1	8	18,5	214	680
62	ML5810	U	U	8	18,5	238	165
63	ML5496	Y1	D	8	18,5	226	100
65	ML6015	U	U	8	18,5	232,5	305
65	ML5932	S1	S1	8	18,5	291	540
65,5	ML6104	U	C1	8	18,5	299	670
67	ML5085	U	U	10	22	249	850
70	ML5803	S1	S1	8	18,5	240	380
70	ML5535	Y1	T1	8	18,5	241	560
70	ML5529	O	M	14	28	270	1600
70	ML6142	U	C1	8	18,5	278	470
70	ML5751	T1	T1	10	22	300	710
71	ML6019	U	U	8	18,5	222,5	500
72	ML6149	G	G	10	22	250	1180
74	ML5404	U	U	8	18,5	240	300
74	ML6031	S1	10	6	15	242	325
74	ML5330	U	U	10	22	250	660
75	ML5481	S1	S1	8	18,5	270	420
75,5	ML6030	M	M	14	28	312,5	1450
76	ML6037	U	C1	8	18,5	241	700
76	ML5611	Y1	D	8	18,5	245	330
77,5	ML6158	7b	44	8	19	281,5	590
77,5	ML6160	7b	44	8	19	281,5	610
78	ML5922	S1	S3	8	18,5	255	350
78	ML5352	U	U	8	18,5	268	510
78,5	ML5962	U	C1	8	18,5	313,5	495
80	ML5629	R	R	6	15	225	100
80	ML5341	U	U	8	18,5	263	520
80	ML5628	U	U	10	22	265	820
80	ML5467	S1	S1	8	18,5	280	420
80	ML5466	S1	S1	8	18,5	280	465
80	ML5260	U	U	8	18,5	293	610
80	ML5170	U	U	8	18,5	295	480
80	ML5745	U	U	10	22	298	700
80	ML5744	U	U	10	22	298	730
82	ML5215	S1	S1	8	18,5	264	370
82	ML5216	S1	S1	8	18,5	264	460
82	ML5921	S1	S1	8	18,5	270	380
83	ML5154	U	U	8	18,5	298	500
83,5	ML5617	N	N	8	18,5	268	450
84	ML5522	10	10	8	18,5	242	380
84	ML6110	S1	S3	8	18,5	283	570
85	ML6333	U	M6	8	18,5	240	410
85	ML5764	U	U	8	18,5	252	425
85	ML5639	Y1	D	8	18,5	254	340
85	ML5748	S1	U	8	18,5	255	600

S	Monroe®	↺	↻	Ød	ØD	Ext. L	F1
85	ML5290	U	U	8	18,5	256	500
85	ML5431	U	U	8	18,5	256	630
85	ML6011	U	U	8	18,5	273	420
85	ML5685	M	O	14	28	320	1200
86	ML5595	Y5	X3	8	18,5	255	370
86	ML5594	Y5	X3	8	18,5	255	600
86	ML5030	Y1	X1	8	18,5	256	180
86	ML5018	Y1	X1	8	18,5	256	280
86	ML5852	G	G	14	28	399	1340
87	ML6047	S1	S1	8	18,5	283	400
88	ML6127	U	S1	8	19	264	355
88	ML6004	S1	S1	8	18,5	292	410
88	ML6177	7b	44	8	19	294	510
88	ML6094	S2	S2	8	18,5	299,5	370
88	ML6092	O	M	14	28	308	1190
88,5	ML6098	S1	U	8	18,5	344,5	450
88,5	ML6099	S1	U	8	18,5	344,5	565
89	ML5226	U	S1	10	22	260	690
89	ML6014	U	K	8	18,5	287	495
89	ML5310	U	U	8	18,5	310	590
89	ML5553	U	U	10	22	310	650
90	ML5643	S1	S1	6	15	244	400
90	ML5566	10	10	8	18,5	254	420
90	ML5633	Y1	D	8	18,5	268	540
90	ML5549	T1	D	8	18,5	270	540
90	ML5533	T1	T1	10	22	272	670
90	ML5927	U	T1	8	18,5	274	740
90	ML5417	S1	S1	8	18,5	275	590
90	ML5274	U	U	8	18,5	278	430
90	ML5273	U	U	8	18,5	278	480
90	ML5234	U	U	10	22	278	630
90	ML5193	U	U	8	18,5	279	530
90	ML5531	S1	T1	8	18,5	280	500
90	ML5786	U	U	8	18,5	280	510
90	ML5558	U	T1	8	18,5	280	550
90	ML5376	U	S1	8	18,5	280	580
90	ML5532	S1	T1	8	18,5	280	600
90	ML6136	U	C1	8	18,5	285	410
90	ML5487	S1	S1	8	18,5	298	600
91	ML6091	U	U	8	18,5	291	600
91	ML6103	U	C1	8	19	319,5	480
91,5	ML6021	1	1	14	28	347,5	1300
92	ML5524	T1	T1	10	22	273	680
92	ML5525	T1	T1	10	22	273	720
92	ML6029	U	13	10	22	301	730
92	ML6145	S1	S3	8	18,5	314	485
94	ML6253	S1	S3	8	18,5	288	260
94	ML6112	U	C	8	18,5	298	430
95	ML5596	Y4	X1	6	15	254	350
95	ML5934	10	10	8	18,5	254	490
95	ML6148	S1	S1	8	18,5	274	320
95	ML5135	U	U	8	18,5	279	490
95	ML5439	U	U	8	18,5	279	520
95	ML5419	S1	S1	8	18,5	280	390
95	ML6120	U	U	8	18,5	280	395
95	ML5483	S1	S1	8	18,5	280	500
95	ML5323	U	U	8	18,5	285	290
95	ML5536	U	Q	8	18,5	288	250
95	ML5861	S1	S1	8	18,5	296	250
95	ML5223	U	U	10	22	298	650
95	ML5355	U	U	8	18,5	310	430
95,5	ML5104	U	S1	8	18,5	280	630
96	ML6106	U	C1	8	18,5	287	520
96	ML5928	S1	S1	8	18,5	305	410

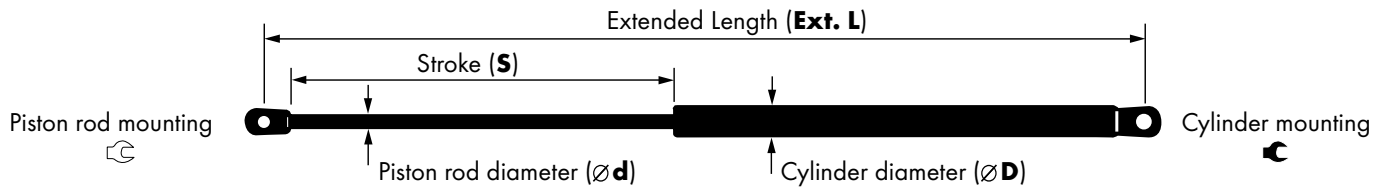

S	Monroe®	C	⌋	Ød	ØD	Ext. L	F1
98	ML5818	U	U	8	18,5	282	560
99	ML5259	U	U	8	18,5	287	365
99	ML5502	S1	S1	8	18,5	300	560
100	ML6076	U	T1	10	22	282	680
100	ML5063	U	U	8	18,5	284	315
100	ML6101	S1	S1	6	15	285	300
100	ML6121	U	C1	8	18,5	285	580
100	ML5769	U	S1	10	22	285	720
100	ML5471	S1	S1	8	18,5	286	310
100	ML5975	S1	S3	8	18,5	288,5	380
100	ML5301	U	U	8	18,5	295	380
100	ML5182	S1	S1	8	18,5	300	410
100	ML5523	S1	12	8	18,5	312	640
100	ML5321	U	U	8	18,5	315	420
100	ML5322	U	U	8	18,5	315	465
100	ML5793	S1	S1	8	18,5	315	550
100	ML5646	Y5	X3	8	18,5	319	370
100	ML6251	Y5	X3	8	18,5	319	430
100	ML5488	S1	S1	8	18,5	320	360
100	ML5674	1	1	14	28	325	1400
100	ML5336	S1	S1	10	22	333	700
100	ML5590	S1	12	8	18,5	346	520
100	ML5163	S1	S1	8	18,5	350	320
100	ML5981	U	U	8	18,5	431	400
101,5	ML5663	U	U	8	18,5	283	450
102	ML6248	S1	S1	6	15	270	130
102	ML6107	S1	S3	8	19	290	395
103	ML5811	U	U	8	18,5	323	700
104	ML5980	U	U	8	18,5	285	230
104	ML5688	S1	S1	8	18,5	288	640
104	ML5946	U	C	8	18,5	293	280
104	ML6242	S1	S3	8	18,5	301	650
105	ML6000	U	U	8	18,5	285	460
105	ML5778	S1	U	8	18,5	285	600
105	ML6062	S1	D	8	18,5	305	370
105	ML6272	U	S2	8	18,5	305	412
105	ML5761	U	U	8	18,5	305	550
105	ML5411	S1	U	8	18,5	315	370
105	ML5727	U	U	8	18,5	320	470
105	ML6280	U	U	8	18,5	320	470
105	ML5982	1	1	14	28	342	1200
105	ML6350	S1	S3	8	18,5	367	280
106	ML6163	7b	44	8	19	298	680
106,5	ML5996	U	C1	8	18,5	300	460
107	ML6249	S1	S1	10	22	287	700
107	ML5698	S1	U	8	18,5	291	380
107	ML6347	S1	S3	8	18,5	365	450
108	ML5637	O	O	14	28	396	1550
109	ML5710	U	U	8	18,5	299	550
109	ML5640	T1	T1	6	15	305	130
110	ML5729	U	U	8	18,5	310	400
110	ML5335	S1	S1	8	18,5	310	580
110	ML5844	U	U	8	18,5	310	590
110	ML5945	P	U	6	15	314	355
110	ML5263	S1	S1	8	18,5	319	580
110	ML5356	U	U	8	18,5	352	150
110	ML6281	S1	S3	8	18,5	369	210
110	ML5658	S1	S1	8	18,5	369	320
110	ML5694	S1	S1	8	18,5	370	320
112	ML5562	S1	S1	8	18,5	313	330
112	ML6141	S1	S1	8	18,5	362	260
112,5	ML5813	S1	S1	6	15	297	240
113	ML6020	S1	10	6	15	289	350
113	ML6154	9	43	8	16	300	400

S	Monroe®	C	⌋	Ød	ØD	Ext. L	F1
113	ML6118	U	C1	8	18,5	340	430
113	ML6204	S1	S3	8	18,5	348	375
115	ML5095	U	U	8	18,5	324	290
115	ML5441	S1	S1	10	22	326	800
115	ML5930	U	U	8	18,5	331	520
116	ML6065	U	C1	8	18,5	314,5	220
116	ML5804	U	U	8	18,5	314,5	330
116	ML5619	N	N	8	18,5	330	340
117	ML5800	U	U	8	18,5	333	650
117	ML6228	U	C1	8	18,5	334	370
117	ML6245	U	C1	8	18,5	362,5	390
117	ML6189	7b	44	8	19	362,5	470
117	ML5670	S1	S1	8	18,5	366	280
117	ML6205	U	C1	8	18,5	450	400
118	ML6193	U	C1	8	18,5	329	380
118	ML6146	S1	S1	6	15	375	180
119	ML6033	U	U	8	18,5	338	420
119	ML5994	U	C1	8	18,5	345	510
120	ML5740	S1	U	8	18,5	315	440
120	ML5766	S1	S1	8	18,5	318	380
120	ML6006	U	U	8	18,5	319,5	410
120	ML6097	S1	S1	8	18,5	334	610
120	ML6133	S1	S1	8	19	337,5	365
120	ML5442	U	U	8	18,5	348	620
120	ML5696	P	U	8	18,5	355	350
120	ML5623	S1	S1	8	18,5	398	180
121	ML5179	S1	S1	6	15	305,5	45
121	ML6152	S1	P	8	18,5	361,5	540
121	ML5630	S1	S1	10	22	431	680
122	ML6114	S1	H1	6	15	310	255
122	ML5789	U	U	8	18,5	345	350
127	ML5998	C	U	8	18,5	380	200
127	ML5415	U	U	10	22	455	700
128	ML6108	S1	S1	8	19	345	450
128	ML5351	U	U	8	18,5	357	555
130	ML6063	S1	P	6	15	334	270
130	ML5680	U	U	8	18,5	350	440
130	ML6355	U	C1	8	18,5	363	150
130	ML5540	S2	S2	10	22	364	800
130	ML6360	S1	S3	8	18,5	377	740
130	ML5944	P	P	10	22	430,5	1050
130	ML5447	T1	T1	8	18,5	540	170
131	ML6170	7b	13	8	19	370	480
132	ML5490	S1	S1	8	18,5	363	370
132	ML5489	S1	S1	8	18,5	364	310
135	ML5910	U	S1	8	18,5	355	115
135	ML5017	U	X2	8	18,5	362	190
135	ML5552	S1	S1	6	15	365	135
135	ML5365	U	U	8	18,5	365	180
135	ML5366	U	U	8	18,5	365	240
135	ML5303	S1	S1	8	18,5	365	620
135	ML6227	U	U	8	18,5	371	530
135	ML5652	J	S1	8	18,5	375	495
135	ML6215	S1	S3	8	18,5	420	570
136	ML5999	U	U	6	15	346	340
136	ML6349	U	C1	8	18,5	382	270
136	ML6001	Q	Q	10	22	429	838
137	ML5891	S1	S1	8	18,5	383	455
138	ML5823	S1	S1	6	15	362	100
138	ML6286	S1	S3	8	18,5	368	380
138	ML5302	U	U	8	18,5	385	560
139	ML6255	U	C1	8	18,5	365	360
139	ML5967	S1	S1	8	18,5	387	465
139	ML5855	S1	S1	8	18,5	400	400

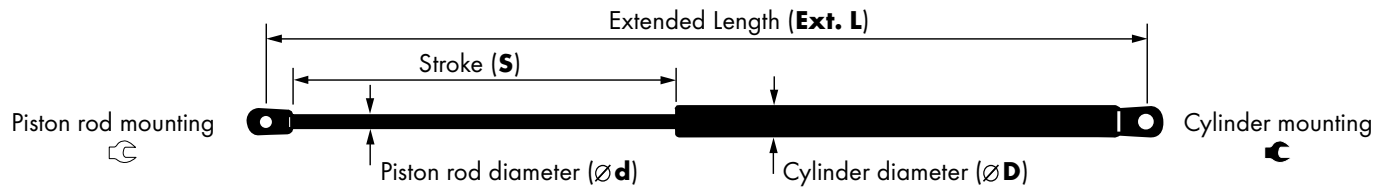

S	Monroe®	C	C	Ød	ØD	Ext. L	F1
140	ML5008	Y1	X1	8	18,5	365	600
140	ML5563	S1	S1	8	18,5	374	350
140	ML5830	U	P	8	18,5	375	390
140	ML5446	T1	T1	10	22	382	660
140	ML5513	T1	T1	10	22	382	660
140	ML5224	U	K	10	22	465	655
141	ML6366	P	C1	8	18,5	456	175
142	ML5599	Y1	X1	6	15	440	380
142	ML6346	S1	C1	8	18,5	462	650
144	ML6186	7b	13	8	19	367	420
144	ML5924	U	C1	8	18,5	375	280
144	ML5539	U	U	10	22	489	720
145	ML5444	10	10	8	18,5	365	410
145	ML5445	10	10	8	18,5	365	480
145	ML5421	10	10	6	15	367	320
145	ML5728	U	U	8	18,5	375	615
145	ML5943	S1	S3	8	18,5	376	390
145	ML5704	T1	T1	8	18,5	378	540
145	ML6035	P	P	8	18,5	386,5	160
145	ML6285	S2	S2	10	22	495	830
145	ML6043	U	U	8	18,5	499	150
146	ML6131	U	U	8	18,5	378	300
146	ML6051	U	U	8	18,5	500	660
148	ML5839	U	K	10	22	390	800
148	ML5387	U	U	8	18,5	395	180
148	ML5426	U	U	10	22	418	700
148	ML6102	U	P	10	22	483,5	750
149	ML6026	U	13	8	18,5	394	400
149	ML5392	S1	S1	8	18,5	400	300
149	ML6027	U	13	8	18,5	429	400
150	ML6090	I	H	6	15	359	180
150	ML5906	I	H	6	15	365,5	290
150	ML6161	7b	44	8	19	376	120
150	ML5762	P	U	8	18,5	385	140
150	ML5714	U	P	8	18,5	386,5	350
150	ML5624	P	T1	8	18,5	392	300
150	ML6137	U	U	8	18,5	393	170
150	ML5472	S1	S1	8	18,5	395	230
150	ML5473	S1	S1	8	18,5	395	470
150	ML5484	S1	S1	8	18,5	400	280
150	ML5277	U	U	8	18,5	405	520
150	ML5316	U	U	8	18,5	408	310
150	ML5868	U	P	8	18,5	414	430
150	ML6250	S1	S3	8	18,5	440	445
150	ML6238	S1	S3	8	18,5	440	705
150	ML6237	S1	S3	8	18,5	440	775
150	ML6203	U	C1	8	18,5	475	610
150	ML5872	S1	S1	8	18,5	516,5	580
151	ML6225	S1	S3	8	18,5	388	480
151	ML6247	U	C1	8	18,5	489	110
152	ML5926	U	C1	8	18,5	408	265
152	ML5925	U	C1	8	18,5	408	390
152	ML6307	P	S3	8	18,5	455	200
153	ML5486	S1	S1	8	18,5	434	585
154	ML5992	P	U	8	18,5	436	245
155	ML5832	U	P	8	18,5	390	360
155	ML5936	P	U	8	18,5	410	390
155	ML5241	U	U	8	18,5	412	340
155	ML5911	T1	T1	10	22	414	500
155	ML5212	U	U	8	18,5	417	500
155	ML5977	S1	S1	8	18,5	418,5	390
155	ML6086	U	U	8	18,5	439,5	410
155	ML5382	U	S1	8	18,5	440	300
155	ML6179	13	25	10	22	482	700

S	Monroe®	C	C	Ød	ØD	Ext. L	F1
155	ML6188	7b	25	10	22	490	910
155	ML6002	U	U	10	22	569,5	590
157	ML6351	S1	S3	8	18,5	403	120
157	ML6061	U	U	8	18,5	404	260
157	ML6359	S1	S3	8	18,5	437	525
157	ML5653	S1	U	8	18,5	439,5	550
158	ML6244	U	K	10	22	391,5	880
158	ML5706	P	U	8	18,5	395	440
158	ML6028	S1	12	8	18,5	397	295
158	ML6184	9	43	8	19	416	395
158	ML5210	U	U	8	18,5	440,5	370
160	ML6191	S1	S3	8	18,5	399	250
160	ML5870	S1	S1	6	15	400	230
160	ML5689	S1	P	8	18,5	400	330
160	ML5111	U	C1	8	18,5	402	390
160	ML6269	U	C1	8	18,5	402	390
160	ML6150	U	U	8	18,5	402,5	150
160	ML6081	S1	S1	8	18,5	404,5	310
160	ML5649	U	U	8	18,5	405	300
160	ML5275	U	U	8	18,5	405	310
160	ML5723	S1	S1	8	18,5	405	480
160	ML5045	U	C1	8	18,5	405	550
160	ML5449	U	U	8	18,5	405	620
160	ML6140	S1	U	8	18,5	406	335
160	ML6084	T1	T1	8	18,5	414	410
160	ML5801	U	U	8	18,5	415	530
160	ML6197	S1	S3	8	18,5	422	365
160	ML5500	S1	S1	8	18,5	430	470
160	ML6071	U	U	8	18,5	431	600
160	ML5297	U	U	8	18,5	435	100
160	ML6324	T1	T1	10	22	436	363
160	ML5131	U	C1	8	18,5	440	450
160	ML5779	U	U	8	18,5	445	420
160	ML5987	U	S1	8	18,5	449	470
160	ML6206	U	C1	8	18,5	455	570
160	ML5270	U	U	8	18,5	460	300
160	ML5753	U	U	8	18,5	470	630
160	ML5787	T1	T1	10	22	550	710
161	ML6308	S1	S1	10	22	506	720
162	ML5682	U	U	8	18,5	420	600
162	ML6302	S1	S3	6	15	442	160
162	ML5151	U	U	8	18,5	445	420
162	ML5331	U	K	10	22	450	740
162	ML6344	U	C1	8	18,5	451	480
162	ML6135	S1	S3	8	18,5	473,5	535
163	ML5736	S1	U	8	18,5	404,5	460
163	ML5691	S1	U	8	18,5	412	400
163	ML5802	U	U	8	18,5	418	490
163	ML5485	S1	U	8	18,5	468	440
163	ML6117	U	C1	8	18,5	527	535
163	ML6116	U	C1	8	18,5	527	610
163	ML6113	Q	Q	10	22	539	690
164	ML5846	U	D	8	18,5	405	270
164	ML5165	U	U	8	18,5	455	380
165	ML5625	Y1	U	8	18,5	419	360
165	ML5845	U	U	8	18,5	419	510
165	ML5669	U	U	8	18,5	424,5	450
165	ML5695	S1	U	8	18,5	425	350
165	ML5939	U	U	8	18,5	427	240
165	ML5507	T1	T1	8	18,5	433	500
165	ML5900	S1	S1	8	18,5	443,5	455
165	ML5655	S1	U	8	18,5	456	320
165	ML6214	S1	S3	8	18,5	470	510
165	ML5332	U	U	8	18,5	485	640

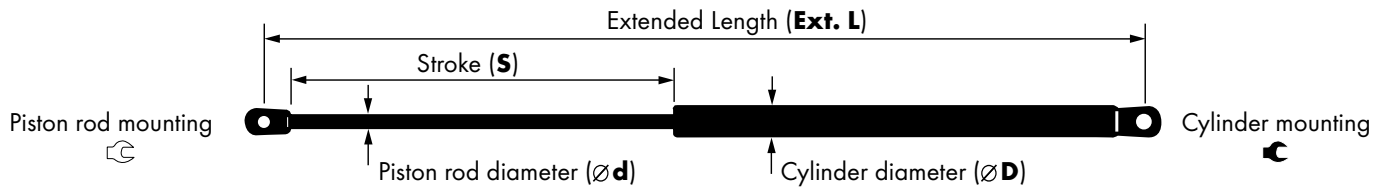

S	Monroe®	C	⌄	∅d	∅D	Ext. L	F1
165	ML6239	U	C1	8	18,5	485	660
165	ML6224	O	O	8	18,5	565	600
166	ML5422	10	10	6	15	410	280
166	ML6132	S1	S1	8	19	441	530
166	ML5568	S1	S1	8	18,5	464	160
167	ML6100	U	U	8	18,5	457	320
167,5	ML6144	S1	C1	8	18,5	587,5	590
169	ML5175	U	C1	8	18,5	440	600
169	ML5280	U	U	8	18,5	441,5	460
169	ML5153	S1	S1	8	18,5	460	100
169	ML5492	Y1	D	8	18,5	465	113
170	ML5777	U	U	8	18,5	430	370
170	ML5414	S1	S1	8	18,5	438	480
170	ML5661	U	U	8	18,5	440	470
170	ML5894	U	U	8	18,5	446	490
170	ML5230	S1	S1	6	15	447	130
170	ML5108	U	U	8	18,5	450	460
170	ML5308	U	U	8	18,5	450	490
170	ML6169	7b	13	8	19	452	660
170	ML5028	U	U	8	18,5	460	220
170	ML5097	U	U	8	18,5	460	270
170	ML5785	S1	S1	8	18,5	460	350
170	ML5383	U	S1	8	18,5	473,5	590
170	ML5632	Y1	D	8	18,5	486	585
170	ML5110	U	U	8	18,5	500	635
170	ML5743	U	P	10	22	505	770
170	ML6321	U	P	8	18,5	589	540
171	ML5222	S1	U	8	18,5	440	370
171	ML5082	U	U	8	18,5	469,5	560
171	ML5358	U	U	8	18,5	500	400
172	ML5183	U	U	8	18,5	445	250
172	ML5096	U	U	8	18,5	447	500
172	ML5587	S1	S1	8	18,5	459	230
172	ML6159	9	43	8	19	466,5	455
172	ML5087	U	C1	8	18,5	473	420
172	ML5838	P	P	8	18,5	494	500
172	ML5641	S1	S1	8	18,5	511,5	545
172	ML5950	U	U	10	22	700	1050
173	ML6046	U	U	8	18,5	431	320
173	ML5145	U	C1	8	18,5	431	380
173	ML5775	S1	S1	8	18,5	437	350
173	ML5700	U	U	8	18,5	480	135
173	ML5512	U	U	10	22	480	690
173	ML5666	U	U	8	18,5	531	545
173	ML6213	U	C1	8	18,5	550	715
174	ML5867	U	U	8	18,5	460,5	350
174	ML6016	U	S3	8	18,5	479	580
175	ML6082	S1	S1	8	18,5	435	170
175	ML5676	U	U	8	18,5	436	150
175	ML5660	P	U	8	18,5	441	300
175	ML6105	S1	S1	6	15	445	110
175	ML5814	U	U	8	18,5	447	300
175	ML5116	U	U	8	18,5	450	160
175	ML5025	U	U	8	18,5	450	260
175	ML5298	U	U	8	18,5	450	260
175	ML5035	U	U	8	18,5	450	280
175	ML5024	U	C1	8	18,5	450	340
175	ML5114	U	U	8	18,5	450	340
175	ML6304	U	U	8	18,5	450	380
175	ML6279	U	U	8	18,5	450	430
175	ML5121	S1	S1	8	18,5	450	600
175	ML5413	S1	U	8	18,5	472	590
175	ML5719	U	P	8	18,5	475	510
175	ML5511	U	U	10	22	483	690

S	Monroe®	C	⌄	∅d	∅D	Ext. L	F1
175	ML5510	U	U	10	22	483	740
175	ML6115	U	C1	8	18,5	492	475
175	ML6038	T1	T1	10	22	500	630
175	ML5291	U	U	8	18,5	501	595
175	ML5612	U	U	10	22	501	780
175	ML6240	U	C1	8	18,5	507	435
175	ML5475	U	U	8	18,5	520	640
175	ML5690	S1	S1	8	18,5	530	530
175	ML6216	S1	K	10	22	542	740
176	ML6083	S1	S3	8	18,5	445	90
176	ML5160	S1	S1	8	18,5	458	430
176	ML6336	S1	S3	8	18,5	472,5	400
176	ML6367	U	P	8	18,5	476	530
176	ML6178	7b	44	8	19	477	650
176	ML5701	S1	U	8	18,5	590	435
177	ML6335	S1	S3	8	18,5	439	100
177	ML5480	S1	S1	8	18,5	452	350
178	ML5158	U	U	8	18,5	465	425
178	ML5806	U	P	10	22	560	725
179	ML5941	S1	S1	8	18,5	449	520
179	ML5805	P	U	8	18,5	479	340
179	ML6194	U	C1	8	18,5	580	550
180	ML5733	S1	S1	6	15	435	105
180	ML6329	S1	S3	8	18,5	445	220
180	ML5079	U	U	8	18,5	445	300
180	ML5136	U	U	8	18,5	448	310
180	ML5343	U	U	8	18,5	448	590
180	ML5003	U	U	8	18,5	450	300
180	ML5742	S1	U	8	18,5	450	535
180	ML5831	U	S1	8	18,5	450	550
180	ML6325	T1	T1	10	22	455	300
180	ML5438	S1	S1	8	18,5	459,5	535
180	ML5453	U	U	8	18,5	460	380
180	ML5734	S1	S1	8	18,5	460	440
180	ML5920	U	U	8	18,5	470	350
180	ML5164	U	U	8	18,5	472	330
180	ML5339	S1	U	8	18,5	480	300
180	ML5043	Y1	X1	8	18,5	490	480
180	ML6012	P	P	10	22	496	635
180	ML6341	U	C1	8	18,5	500	440
180	ML5618	N	N	8	18,5	505	430
180	ML5873	U	P	8	18,5	514	335
180	ML5826	U	C1	8	18,5	520	625
180	ML6331	U	U	10	22	520	660
180	ML5433	U	U	10	22	520	665
180	ML6167	7b	44	8	19	537	670
180,5	ML6087	S1	S1	8	18,5	495	510
180,5	ML5963	S1	S1	8	18,5	495	570
181	ML6123	U	U	8	19	450	395
182	ML6009	S1	S1	8	18,5	456	185
182	ML5257	U	U	8	18,5	470	600
182	ML5757	U	U	8	18,5	473	540
182	ML5219	U	U	8	18,5	495	515
182	ML5221	U	U	8	18,5	495	565
182	ML6322	U	C1	8	18,5	540	420
183	ML5699	P	S1	8	18,5	445	550
183	ML5907	S1	S3	8	18,5	481	360
183	ML6176	7b	13	8	19	495	460
183	ML5781	U	S1	10	22	535	710
183	ML5367	U	U	8	18,5	567,5	430
184	ML5258	U	U	8	18,5	471	570
184	ML5746	U	P	8	18,5	475	650
184	ML5254	U	U	8	18,5	476,5	420
184	ML6192	U	C1	8	18,5	500	440

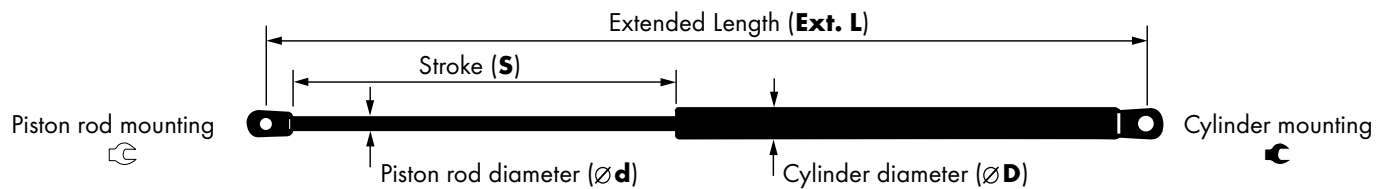

S	Monroe®	C	↻	$\varnothing d$	$\varnothing D$	Ext. L	F1
184	ML6226	U	C1	8	18,5	500	530
184	ML6008	S1	S1	8	18,5	516	160
184	ML5864	U	U	8	18,5	519	370
185	ML5725	S1	S1	8	18,5	451	385
185	ML6187	7b	44	8	19	453	460
185	ML6236	U	C1	8	18,5	454	330
185	ML5796	S1	U	8	18,5	463	360
185	ML5656	P	P	8	18,5	469,5	580
185	ML5702	P	S1	8	18,5	470	480
185	ML5427	S1	U	8	18,5	471	380
185	ML5871	S1	S1	8	18,5	480	480
185	ML5569	S1	S1	8	18,5	485	580
185	ML6171	7b	13	8	19	486	500
185	ML5460	S1	S1	8	18,5	494	490
185	ML6220	S1	C1	8	18,5	519	530
185	ML5580	U	U	10	22	520	730
185	ML5788	T1	T1	8	18,5	554	200
185,5	ML5817	P	U	10	22	482	700
186	ML6180	9	43	8	19	469	430
186	ML6022	U	C1	8	18,5	506,5	485
186	ML6023	U	C1	8	18,5	506,5	515
186	ML6057	U	C1	10	22	598,5	700
186	ML6207	U	C1	8	18,5	630	480
186	ML6195	U	U	10	22	656	880
186	ML6138	U	U	8	18,5	669	200
187	ML5420	Y1	D	8	18,5	465	320
187	ML5380	U	S1	8	18,5	485	610
187	ML5570	S1	S1	8	18,5	490	380
187	ML6134	S1	S3	8	18,5	503,5	450
187	ML5622	S1	S1	8	18,5	515	490
187	ML6340	S1	S3	8	18,5	516	560
188	ML5032	U	U	8	18,5	473	530
188	ML5462	S1	S1	8	18,5	477	360
188	ML5557	U	U	10	22	492	710
188	ML5098	P	P	8	18,5	496	270
188	ML5889	S1	S1	8	18,5	527	620
189	ML6119	U	C1	8	18,5	480	600
189	ML5307	U	U	8	18,5	485	450
189	ML6229	S1	S3	8	18,5	486	363
189	ML5979	U	U	8	18,5	490	560
190	ML5794	T1	T1	8	18,5	462,5	560
190	ML5840	I	H	6	15	465	335
190	ML5069	U	U	8	18,5	470	350
190	ML5721	U	U	8	18,5	474	570
190	ML5703	P	U	8	18,5	480	420
190	ML5650	P	U	8	18,5	484	200
190	ML5159	S1	S1	8	18,5	485	320
190	ML6183	9	13	8	19	487	645
190	ML6353	S1	S3	8	18,5	488	190
190	ML5180	U	U	8	18,5	490	250
190	ML6036	U	U	8	18,5	495	370
190	ML5572	Y1	U	8	18,5	500	220
190	ML5360	U	U	8	18,5	500	360
190	ML5857	P	P	8	18,5	500	500
190	ML5856	U	U	8	18,5	500	600
190	ML5256	U	U	8	18,5	505	520
190	ML5684	U	U	8	18,5	515	490
190	ML5436	S1	S1	8	18,5	517	420
190	ML5895	U	U	8	18,5	532,5	360
190	ML5357	U	U	8	18,5	538	125
190	ML5551	S1	S1	6	15	547	170
190	ML6330	U	15	8	18,5	560	590
190	ML5986	S1	C1	8	18,5	577	530
190	ML5783	U	P	8	18,5	585	625

S	Monroe®	C	↻	$\varnothing d$	$\varnothing D$	Ext. L	F1
190	ML5235	U	U	8	18,5	596	380
190	ML5237	U	U	8	18,5	596	420
190	ML5206	U	U	8	18,5	599	425
190	ML5207	U	U	8	18,5	600	440
190	ML5311	U	U	8	18,5	640	470
191	ML5093	S1	S1	8	18,5	471	360
191	ML6181	28	9	8	19	477	100
191	ML5759	T1	T1	8	18,5	483	370
191	ML5929	P	P	10	22	498	630
191	ML6151	S1	C1	8	18,5	517,5	295
192	ML6243	U	C1	8	18,5	470	245
192	ML5080	U	U	8	18,5	495	500
192	ML5253	U	U	8	18,5	496,5	565
193	ML5459	S1	S1	8	18,5	485	460
193	ML5198	S1	U	8	18,5	500	470
193	ML5137	U	U	8	18,5	542	590
193	ML6327	U	C1	8	18,5	548	520
193	ML5424	U	S1	8	18,5	567	540
194	ML5995	U	P	8	18,5	494	250
194	ML5390	U	U	8	18,5	508	350
194	ML6233	U	C1	8	18,5	535	455
194	ML6357	P	C1	8	18,5	584	600
195	ML5120	U	C1	8	18,5	475	350
195	ML5773	U	U	8	18,5	475	640
195	ML5708	U	U	8	18,5	480	335
195	ML6073	U	U	8	18,5	482,5	705
195	ML6129	U	U	8	19	488	510
195	ML5495	U	U	8	18,5	490	610
195	ML5917	S1	S1	8	18,5	493	445
195	ML5909	I	U	8	18,5	496,5	340
195	ML5371	U	U	8	18,5	499	400
195	ML5767	S1	U	8	18,5	500	340
195	ML6157	7b	44	8	19	500	560
195	ML5635	Y1	D	8	18,5	500	650
195	ML5239	P	U	10	22	500	690
195	ML5615	U	P	8	18,5	502	400
195	ML5732	S1	S1	8	18,5	505	490
195	ML5156	P	P	8	18,5	508	550
195	ML5125	U	U	8	18,5	508	600
195	ML5124	U	U	8	18,5	515	500
195	ML6315	S1	S3	8	18,5	533	460
195	ML5668	S1	U	8	18,5	545	425
195	ML5591	U	Q	10	22	545	750
195	ML5912	S1	U	8	18,5	567	550
195	ML5236	U	U	8	18,5	596	430
195	ML6218	U	C1	8	18,5	600	580
195	ML5947	P	P	10	22	665	765
196	ML5293	U	U	8	18,5	485	460
196	ML5294	U	U	8	18,5	485	520
196	ML5217	U	U	8	18,5	493	470
196	ML5306	U	U	8	18,5	500	225
196	ML5760	P	U	8	18,5	515	585
196	ML5119	U	U	8	18,5	540	540
197	ML5776	U	P	8	18,5	495	420
197	ML5406	U	U	8	18,5	498	330
197	ML5296	U	U	8	18,5	520	435
198	ML5747	T1	T1	8	18,5	490	530
198	ML5218	U	U	8	18,5	495	500
198	ML5990	U	U	8	18,5	512	460
198	ML6172	7b	13	8	19	520	540
198	ML5231	U	U	8	18,5	535	485
198	ML5232	U	U	8	18,5	535	520
198	ML5233	U	U	8	18,5	535	585
198	ML6058	S1	S1	10	22	537	750

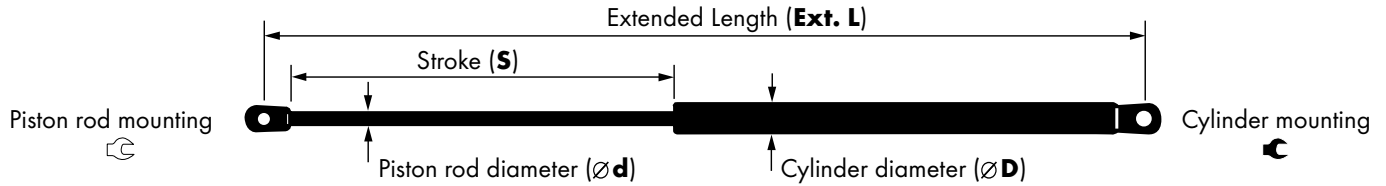

S	Monroe®	↺	↻	∅d	∅D	Ext. L	F1
198	ML5771	P	P	10	22	574	990
198	ML5958	U	P	8	18,5	588	645
198	ML5537	U	U	10	22	603	810
198	ML5538	U	U	10	22	603	850
199	ML5416	U	U	8	18,5	481,5	530
199	ML6235	U	C1	8	18,5	487,5	320
199	ML5101	S1	S1	8	18,5	502	280
199	ML5408	U	U	8	18,5	511	520
200	ML6200	S1	S3	8	18,5	471	400
200	ML6196	S1	S3	8	18,5	472	400
200	ML5792	U	P	8	18,5	480	550
200	ML5739	U	P	8	18,5	485	170
200	ML5647	P	S1	8	18,5	485	565
200	ML5712	P	U	8	18,5	490	380
200	ML5667	U	U	8	18,5	490,5	480
200	ML5717	P	U	8	18,5	497	430
200	ML5287	S1	U	8	18,5	500	190
200	ML5600	Y1	D	8	18,5	500	230
200	ML5574	U	D	8	18,5	500	270
200	ML5038	U	U	8	18,5	500	280
200	ML5195	S1	U	8	18,5	500	280
200	ML5491	S1	U	8	18,5	500	310
200	ML5284	S1	U	8	18,5	500	320
200	ML5261	S1	U	8	18,5	500	350
200	ML5264	S1	U	8	18,5	500	350
200	ML5199	S1	U	8	18,5	500	365
200	ML5194	S1	U	8	18,5	500	380
200	ML5115	U	U	8	18,5	500	400
200	ML5196	S1	U	8	18,5	500	400
200	ML5181	S1	U	8	18,5	500	450
200	ML5225	S1	U	8	18,5	500	470
200	ML5774	T1	P	8	18,5	500	525
200	ML5238	S1	P	8	18,5	500	635
200	ML5240	P	P	10	22	500	635
200	ML5547	S1	S1	6	15	502	125
200	ML6283	U	U	8	18,5	502	250
200	ML5072	U	U	8	18,5	502	280
200	ML5004	U	U	8	18,5	502	400
200	ML5227	S1	S1	8	18,5	502	530
200	ML5281	U	U	8	18,5	506	380
200	ML5005	U	U	8	18,5	509	420
200	ML5361	U	U	8	18,5	510	320
200	ML5370	U	P	8	18,5	510	370
200	ML5645	Y1	U	8	18,5	512	300
200	ML6173	9	9	8	19	512	470
200	ML5985	T1	T1	10	22	512	520
200	ML5168	U	U	8	18,5	512	550
200	ML5410	S1	S1	8	18,5	515	445
200	ML5478	S1	S1	8	18,5	515	490
200	ML5214	S1	S1	8	18,5	517	460
200	ML6128	S1	S1	8	19	523	600
200	ML5560	U	13	8	18,5	525	280
200	ML5581	U	U	10	22	527	660
200	ML5724	S1	S1	8	18,5	533	515
200	ML5157	U	U	10	22	540	450
200	ML5213	S1	S1	8	18,5	540	450
200	ML5334	U	U	8	18,5	549,5	610
200	ML5642	T1	T1	8	18,5	550	460
200	ML5209	U	U	8	18,5	552	410
200	ML5176	S1	U	8	18,5	552	560
200	ML5126	S1	U	8	18,5	554	515
200	ML6277	U	C1	8	18,5	554	670
200	ML5493	S1	S1	8	18,5	558	135
200	ML5319	U	U	8	18,5	558	550

S	Monroe®	↺	↻	∅d	∅D	Ext. L	F1
200	ML5577	U	13	8	18,5	563	280
200	ML5973	S1	S1	8	18,5	565	200
200	ML5616	S1	U	8	18,5	570	630
200	ML6042	S1	S1	8	18,5	580	560
200	ML5127	U	U	10	22	591	830
200	ML5305	U	U	8	18,5	610	560
200	ML5627	U	U	8	18,5	610	560
200	ML5456	U	U	8	18,5	610	600
200	ML6354	U	U	10	22	657	540
200	ML6356	U	U	10	22	697	650
200	ML5518	U	U	10	22	730	700
200	ML5519	U	U	10	22	730	760
201	ML5613	Y1	D	8	18,5	500	600
201	ML5683	P	U	8	18,5	580	510
202	ML6314	S1	S3	8	18,5	495	475
202	ML5103	U	U	8	18,5	510	620
202	ML5068	U	U	8	18,5	515	370
202	ML5579	S1	S1	8	18,5	523	530
202	ML5300	U	U	8	18,5	527	390
202	ML6306	U	P	10	22	555	585
202	ML6300	U	U	10	22	739	700
202	ML6301	U	U	10	22	739	850
202,6	ML5088	E2	E3	8	18,5	645	470
202,6	ML5089	E2	E3	8	18,5	645	470
203	ML5821	S1	U	8	18,5	500	245
203	ML5377	U	S1	8	18,5	507	520
203	ML5673	U	U	8	18,5	582	460
204	ML6190	S1	S3	8	18,5	500	420
204	ML5100	S1	S1	8	18,5	500	480
204	ML5094	U	U	8	18,5	500	500
204	ML6164	7b	44	8	19	509,5	350
204	ML5809	S1	S1	8	18,5	536	410
204	ML5138	U	U	8	18,5	566	500
204	ML6122	P	P	8	19	588	400
204	ML6044	S1	S1	8	18,5	643	475
205	ML5425	U	C1	8	18,5	491	600
205	ML5681	U	U	8	18,5	495	440
205	ML5657	S1	S1	8	18,5	495	610
205	ML5677	Y1	T1	8	18,5	499	460
205	ML5197	S1	U	8	18,5	500	420
205	ML5185	S1	U	8	18,5	500	470
205	ML5923	U	U	8	18,5	502	450
205	ML5132	S1	U	8	18,5	502	500
205	ML5918	U	U	8	18,5	502	530
205	ML5997	P	S1	8	18,5	505	585
205	ML5722	U	U	10	22	505	610
205	ML5461	S1	S1	8	18,5	506	180
205	ML5078	U	U	8	18,5	507	420
205	ML6219	U	C1	8	18,5	510	270
205	ML6013	S1	S1	10	22	515,5	610
205	ML5405	U	U	8	18,5	516	425
205	ML6348	S1	S3	8	18,5	520	300
205	ML5347	U	U	8	18,5	525	310
205	ML5348	U	U	8	18,5	525	350
205	ML5166	U	C1	8	18,5	536,5	430
205	ML6080	U	U	8	18,5	538	650
205	ML5208	U	U	8	18,5	552	370
205	ML5289	U	U	8	18,5	556	500
205	ML5620	U	U	8	18,5	580	230
205	ML5989	U	K	10	22	595	680
205	ML5671	U	U	8	18,5	627	660
206	ML6289	U	C1	8	18,5	499	540
206	ML5140	U	U	8	18,5	526	320
206	ML5313	U	U	8	18,5	526	560

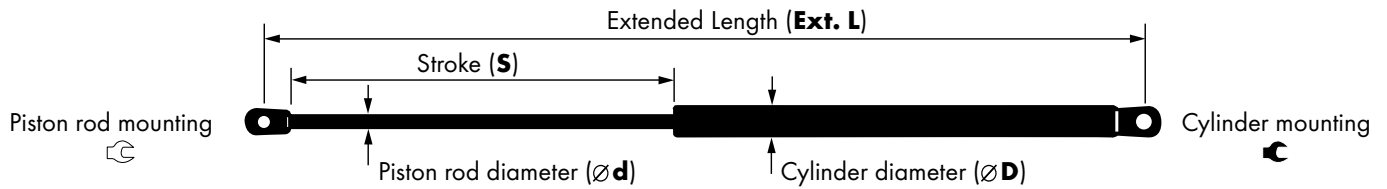

S	Monroe®	C	C	Ød	ØD	Ext. L	F1
206	ML5169	U	U	8	18,5	527	450
206	ML5242	U	U	8	18,5	543,5	320
206	ML5054	U	U	8	18,5	543,5	360
207	ML6230	U	P	8	18,5	498	550
207	ML5073	Y1	X1	8	18,5	501	480
207	ML5178	U	U	8	18,5	507	550
207	ML5189	S1	S1	8	18,5	513	535
207	ML5190	S1	S1	8	18,5	513	585
207	ML6316	P	P	8	18,5	526	555
207	ML5086	S1	S1	8	18,5	526	570
207	ML5109	U	U	8	18,5	544	495
208	ML5752	U	U	8	18,5	500	375
208	ML5362	U	U	8	18,5	507	436
208	ML5395	U	U	8	18,5	510	390
208	ML5391	U	U	8	18,5	510	470
208	ML5812	U	U	8	18,5	520	130
208	ML5961	S1	S3	8	18,5	526,5	125
208	ML5346	U	U	8	18,5	571	570
208	ML6165	7b	44	8	19	687	555
209	ML5036	Y1	X1	8	18,5	518	220
209	ML6305	U	C1	8	18,5	684	505
210	ML6126	S1	S1	8	18,5	505	300
210	ML5146	S1	S1	8	18,5	510	340
210	ML5890	S1	S1	8	18,5	515	365
210	ML5711	U	U	8	18,5	515	490
210	ML5123	S1	S1	8	18,5	515	500
210	ML5177	U	U	8	18,5	515	550
210	ML6153	7b	44	8	19	515	600
210	ML5271	U	U	8	18,5	522	300
210	ML5272	U	U	8	18,5	522	400
210	ML6130	P	U	8	19	522	490
210	ML5340	U	U	8	18,5	525	140
210	ML5350	U	U	8	18,5	525	240
210	ML5636	U	U	8	18,5	525	240
210	ML5349	U	U	8	18,5	525	480
210	ML5211	U	U	8	18,5	527	350
210	ML5061	U	C1	8	18,5	527	450
210	ML5749	U	P	8	18,5	530	410
210	ML6352	S1	S3	8	18,5	535	380
210	ML5672	U	U	8	18,5	540	385
210	ML5041	U	U	8	18,5	542	300
210	ML5252	U	U	8	18,5	544	440
210	ML5692	U	U	8	18,5	545	450
210	ML5378	U	S1	8	18,5	545	490
210	ML5379	U	S1	8	18,5	545	530
210	ML5707	U	U	8	18,5	545	620
210	ML5228	U	K	10	22	560	730
210	ML5229	U	U	10	22	560	800
210	ML5412	S1	U	8	18,5	565	560
210	ML5469	S1	S1	8	18,5	581,5	535
210	ML6198	S1	S3	8	18,5	588	360
210	ML5279	S1	U	8	18,5	595	470
210	ML5544	U	S1	8	18,5	596	450
210	ML5545	U	S1	8	18,5	596	510
210	ML5866	U	P	10	22	625	510
210	ML5693	P	S1	8	18,5	625	590
210	ML5515	U	U	10	22	722	819
210	ML5575	U	P	10	22	755	970
210	ML5576	U	U	10	22	755	1080
210	ML5833	U	P	10	22	755	1080
211	ML5731	S1	P	8	18,5	505	330
212	ML5049	U	C1	8	18,5	500	350
212	ML6318	P	P	8	18,5	512	475
212	ML5983	U	P	10	22	524	540

S	Monroe®	C	C	Ød	ØD	Ext. L	F1
212	ML5984	U	P	10	22	524	585
212	ML5754	U	P	8	18,5	528	420
212	ML5006	Y2	X2	8	18,5	550	230
212	ML5130	U	C1	8	18,5	596,5	515
213	ML5784	U	U	8	18,5	510	360
213	ML5056	Y1	X1	8	18,5	520	230
213	ML5548	S1	S1	6	15	530	110
213	ML5373	U	U	8	18,5	548	475
213	ML5396	U	U	8	18,5	568	360
214	ML5188	U	U	8	18,5	540	400
214	ML5556	Y1	X1	6	15	547	225
215	ML6232	U	C1	8	18,5	504	355
215	ML5359	U	U	8	18,5	513	350
215	ML5713	U	U	8	18,5	515	400
215	ML5644	T1	D	8	18,5	515	550
215	ML5276	U	U	8	18,5	529	245
215	ML5167	U	U	8	18,5	535	480
215	ML5372	U	U	8	18,5	546	500
215	ML5381	U	S1	8	18,5	557	550
215	ML6223	U	C1	8	18,5	561	445
215	ML5730	U	U	8	18,5	565	315
215	ML5388	U	U	8	18,5	565	480
215	ML5541	S1	S1	8	18,5	568	410
215	ML5338	U	U	8	18,5	570	530
215	ML5554	U	T1	10	22	573,5	580
215	ML5555	U	T1	10	22	573,5	670
215	ML5317	U	U	8	18,5	590	410
215	ML5318	U	U	8	18,5	590	450
215	ML5503	T1	T1	8	18,5	600	510
215	ML5504	T1	T1	8	18,5	600	550
215	ML5363	U	U	8	18,5	632	600
215	ML5455	U	U	8	18,5	632	600
215	ML5542	U	U	8	18,5	667	375
215	ML5403	U	U	8	18,5	668	375
216	ML6024	P	13	8	18,5	533	330
216	ML5161	U	U	8	18,5	534	410
216	ML6217	U	C1	8	18,5	552	295
216	ML6276	U	13	8	18,5	558	470
216	ML5144	U	U	8	18,5	565	360
216	ML6241	S1	S3	8	18,5	632,5	550
217	ML5106	U	D	8	18,5	514,5	610
217	ML6313	P	13	8	18,5	532	355
217	ML5509	T1	T1	8	18,5	534	200
217	ML6291	U	C1	8	18,5	543,5	460
218	ML6210	U	P	8	18,5	527	390
218	ML6363	S1	P	8	18,5	530	425
218	ML5772	T1	P	8	18,5	539	585
218	ML5651	P	U	8	18,5	544	290
218	ML6053	U	C1	8	18,5	652	750
219	ML5048	U	U	8	18,5	527	420
219	ML5044	U	U	8	18,5	527	450
219	ML5064	U	U	8	18,5	527	520
219	ML6040	U	U	8	18,5	549	290
220	ML6328	U	C1	8	18,5	525	150
220	ML5849	U	U	8	18,5	526	325
220	ML6075	U	K	10	22	533	750
220	ML5440	S1	S1	8	18,5	534,5	480
220	ML5474	S1	S1	8	18,5	535	425
220	ML6005	S1	S1	8	18,5	538	510
220	ML5327	U	U	8	18,5	540	250
220	ML5506	T1	T1	8	18,5	540	490
220	ML5954	U	U	8	18,5	543	200
220	ML5720	U	U	8	18,5	543	310
220	ML5314	U	U	8	18,5	545	530

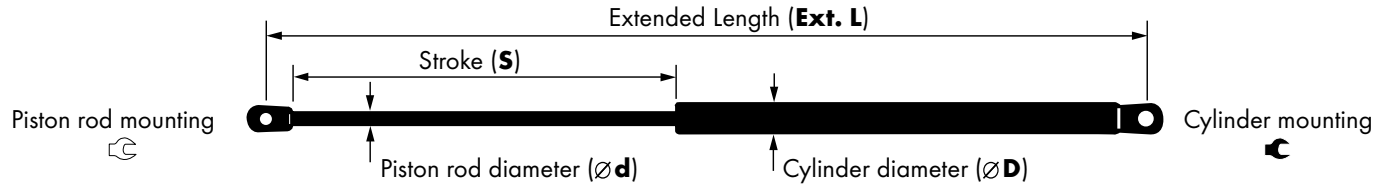

S	Monroe®	↺	↻	Ød	ØD	Ext. L	F1
220	ML5718	U	U	10	22	547	460
220	ML5828	U	P	8	18,5	547	550
220	ML5862	S1	S1	8	19	548	420
220	ML5292	U	U	8	18,5	550	285
220	ML5353	U	U	8	18,5	555	450
220	ML5991	U	U	8	18,5	557	580
220	ML5588	S1	S1	8	18,5	559	330
220	ML5765	T1	T1	8	18,5	565	500
220	ML5040	U	U	8	18,5	569	280
220	ML5437	S1	U	8	18,5	575	500
220	ML5324	U	U	8	18,5	590	480
220	ML5434	U	U	8	18,5	599	360
220	ML6041	T1	T1	10	22	600	325
220	ML5443	U	U	10	22	603	740
220	ML5505	T1	T1	8	18,5	630	570
221	ML5141	U	U	10	22	567	590
221	ML5142	U	U	10	22	567	650
222	ML6143	U	U	8	18,5	547	535
222	ML5031	U	U	8	18,5	549	355
222	ML5571	T1	T1	8	18,5	550	475
222	ML5134	U	U	8	18,5	585	280
223	ML5184	S1	P	8	18,5	600,5	320
224	ML5026	U	U	8	18,5	528	160
224	ML5099	U	U	8	18,5	528	220
224	ML5607	S1	S1	8	18,5	544	250
224	ML5797	T1	T1	10	22	556	715
224	ML6290	U	K	8	18,5	556,5	450
224	ML5171	U	U	8	18,5	557	360
224	ML5172	U	U	8	18,5	557	425
225	ML5592	S1	S1	8	18,5	498	540
225	ML6155	7b	44	8	19	536	540
225	ML5763	T1	T1	8	18,5	540	390
225	ML5457	U	U	8	18,5	546	220
225	ML5659	S1	S1	8	18,5	553	220
225	ML5374	U	U	8	18,5	556	475
225	ML5248	U	U	10	22	567	460
225	ML5564	U	P	8	18,5	577	270
225	ML6124	U	P	8	19	590	590
225	ML5320	U	U	8	18,5	600	450
225	ML5968	U	U	8	18,5	600	670
225	ML6017	U	U	8	18,5	604	510
225	ML5948	U	S1	10	22	620	625
225	ML5567	S1	S1	8	18,5	635	200
226	ML5463	S1	S1	8	18,5	577	275
226	ML5464	S1	S1	8	18,5	577	320
226	ML5201	U	U	8	18,5	577	400
226	ML5200	U	U	8	18,5	577	415
226	ML5394	U	U	8	18,5	600	360
228	ML5687	U	U	8	18,5	555	305
228	ML5173	U	U	8	18,5	555	485
228	ML6109	U	U	8	19	567	460
228	ML5815	U	U	8	18,5	600	360
228	ML6089	T1	T1	8	18,5	611	420
229	ML5465	S1	S1	8	18,5	614	300
229,5	ML5016	Y1	X2	8	18,5	549	240
229,5	ML5015	Y1	X1	8	18,5	549	350
229,5	ML5055	Y1	X1	8	18,5	549,5	160
229,5	ML5039	Y1	X2	8	18,5	550	380
230	ML5825	S1	S1	8	18,5	500	135
230	ML5312	U	U	8	18,5	545	300
230	ML5597	U	X1	8	18,5	547	230
230	ML5850	S1	P	8	18,5	559	290
230	ML5202	U	U	8	18,5	566	440
230	ML5375	U	U	8	18,5	568	500

S	Monroe®	↺	↻	Ød	ØD	Ext. L	F1
230	ML5397	U	U	8	18,5	568	560
230	ML5399	U	U	8	18,5	570	215
230	ML5400	U	U	8	18,5	570	420
230	ML5288	U	U	8	18,5	570	460
230	ML5354	U	U	8	18,5	570	490
230	ML5401	U	U	8	18,5	570	520
230	ML5476	S1	S1	8	18,5	574,5	530
230	ML5477	S1	S1	8	18,5	574,5	620
230	ML5482	S1	S1	8	18,5	575	440
230	ML5020	U	U	8	18,5	600	290
230	ML5148	U	U	8	18,5	600	300
230	ML5384	U	S1	8	18,5	606,5	540
230	ML5149	U	U	8	18,5	611	355
230	ML5023	U	U	8	18,5	614	330
230	ML5283	U	U	8	18,5	627	570
230	ML5626	U	U	8	18,5	627	570
230	ML5454	U	U	8	18,5	627	630
230	ML5458	U	U	8	18,5	631	440
230	ML5344	U	U	8	18,5	632	510
232	ML5243	U	U	8	18,5	549	320
232	ML5244	U	U	8	18,5	549	410
232	ML5122	U	U	8	18,5	570	520
232	ML6345	T1	T1	8	18,5	632	280
233	ML5819	U	U	8	18,5	568	330
234	ML5014	U	U	8	18,5	584	280
234	ML5066	U	U	8	18,5	584	290
234	ML6311	U	13	8	18,5	588	300
234	ML6310	U	13	8	18,5	610	300
235	ML6246	U	C1	8	18,5	550	260
235	ML5780	T1	T1	8	18,5	550	280
235	ML5429	U	U	10	22	550	810
235	ML5076	U	U	10	22	550	850
235	ML6319	U	C1	8	18,5	556	240
235	ML5782	T1	T1	8	18,5	558	500
235	ML5824	S1	S1	8	18,5	558	530
235	ML5956	S1	S3	8	18,5	563	140
235	ML5143	U	U	8	18,5	574	260
235	ML5147	U	U	8	18,5	574	310
235	ML5342	U	U	8	18,5	575	330
235	ML5606	Y1	D	8	18,5	579	320
235	ML5265	U	U	8	18,5	585	250
235	ML5842	S2	15	8	18,5	585	310
235	ML5843	S2	16	8	18,5	585	310
235	ML5191	U	U	8	18,5	585	360
235	ML6337	S2	15	8	18,5	585	500
235	ML6338	S2	16	8	18,5	585	500
235	ML5888	T1	T1	8	18,5	585,5	510
235	ML6085	11	11	8	18,5	587	100
235	ML5013	U	U	8	18,5	595	280
235	ML5573	U	D	8	18,5	640	390
237	ML6287	U	K	10	22	743	670
238	ML6125	S1	S1	8	19	665	535
239	ML6202	U	C1	8	18,5	554	550
239	ML5286	U	U	8	18,5	591	400
239	ML6166	7b	44	8	19	600	385
240	ML5705	S1	U	8	18,5	565	290
240	ML5869	U	P	8	18,5	569	310
240	ML5246	U	U	10	22	569	660
240	ML5893	S1	S1	8	18,5	569	670
240	ML5245	U	U	10	22	569	750
240	ML5247	U	U	10	22	569	830
240	ML5105	U	U	10	22	569	910
240	ML5402	U	U	8	18,5	570	470
240	ML5278	U	U	8	18,5	570	520

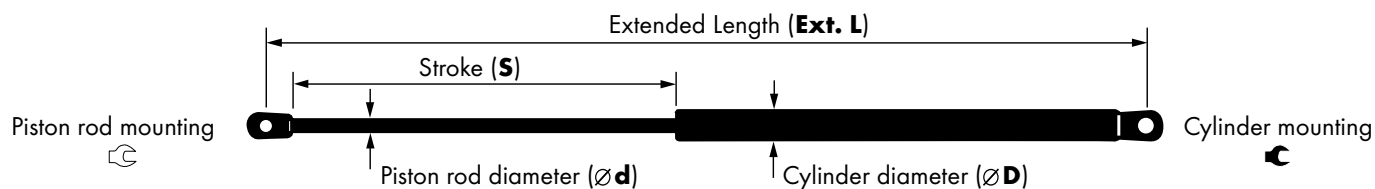

S	Monroe®	⌋	⌍	ød	øD	Ext. L	F1
240	ML5816	T1	T1	10	22	570	650
240	ML5664	U	U	8	18,5	585	420
240	ML5959	S1	S1	8	18,5	589	110
240	ML5077	U	C1	8	18,5	591	350
240	ML6358	P	C1	8	18,5	600	425
240	ML6295	S1	P	8	18,5	605	325
240	ML5847	B2	A2	10	22	610	500
240	ML5848	B1	A1	10	22	610	500
240	ML5129	S1	S1	8	18,5	622	360
240	ML6234	U	K	10	22	640	740
240	ML6162	7b	44	8	19	652	610
240	ML5938	S1	U	8	18,5	672	180
241	ML6362	P	P	8	18,5	602	270
242	ML5081	U	C1	8	18,5	569	210
242	ML5770	P	P	8	18,5	605	655
243	ML5919	Y1	D	8	18,5	615	240
244	ML5325	U	U	8	18,5	600	330
245	ML5822	S1	S1	8	18,5	580	165
245	ML5398	U	U	8	18,5	580	340
245	ML5609	W	D	8	18,5	580	380
245	ML5665	U	U	8	18,5	585,5	405
245	ML6332	U	U	8	18,5	585,5	460
245	ML5662	U	U	8	18,5	590	460
245	ML5430	U	U	8	18,5	590,5	480
245	ML5065	U	U	8	18,5	600	430
246	ML6069	U	P	8	18,5	585	260
246	ML5940	S1	S1	8	18,5	585	500
246,5	ML6201	U	K	10	22	796,5	720
247	ML5428	S1	S1	8	18,5	580	470
247	ML5534	S1	U	8	18,5	605	340
247	ML5582	U	U	10	22	769	475
248	ML6199	S1	S3	8	18,5	579	330
248	ML5285	U	U	8	18,5	595	370
248	ML5585	O	O	10	22	613,5	560
248	ML5527	O	O	10	22	613,5	620
248	ML5586	O	O	10	22	613,5	640
248	ML5091	E4	T1	8	18,5	613,8	190
248	ML5092	E4	T1	8	18,5	613,8	190
248	ML5364	U	U	8	18,5	635	360
249	ML5369	U	U	8	18,5	828	355
250	ML6060	S1	S1	8	18,5	584	150
250	ML5034	Y1	X1	8	18,5	585	200
250	ML6070	U	C1	8	18,5	585	430
250	ML5262	U	U	8	18,5	595	450
250	ML5152	U	C1	8	18,5	595	485
250	ML5598	S1	S1	8	18,5	600	160
250	ML5133	U	U	8	18,5	600	250
250	ML5255	U	U	8	18,5	600	320
250	ML6273	U	U	8	18,5	600	340
250	ML6278	U	U	8	18,5	600	430
250	ML5019	Y1	X1	8	18,5	600	500
250	ML5501	Y2	D	8	18,5	600	540
250	ML5139	S1	S1	8	18,5	602	160
250	ML5578	U	U	8	18,5	650	460
250	ML5249	P	P	10	22	685	710
250	ML5118	P	P	10	22	685	770
250	ML5251	P	P	10	22	685	830
250	ML5250	P	P	10	22	685	910
251	ML5021	U	U	8	18,5	700	200
251,5	ML5807	U	U	8	18,5	609,5	245
252	ML5107	U	U	8	18,5	602	430
252	ML5299	U	U	8	18,5	602	430
252	ML6361	P	P	8	18,5	610	275
253	ML5697	U	U	8	18,5	604	250

S	Monroe®	⌋	⌍	ød	øD	Ext. L	F1
253	ML5205	U	U	8	18,5	625	575
254	ML6312	P	13	8	18,5	568	355
254	ML6025	P	13	8	18,5	570	330
255	ML5009	Y1	X1	8	18,5	600	180
255	ML5010	Y1	X1	8	18,5	600	200
255	ML5042	Y1	X1	8	18,5	600	310
255	ML5011	Y1	X1	8	18,5	600	360
255	ML5067	Y1	X1	8	18,5	600	450
255	ML5827	U	U	8	18,5	603	240
255	ML5756	U	P	8	18,5	640	565
255	ML5755	U	P	8	18,5	640	595
255	ML5716	U	U	10	22	667	755
256	ML6299	U	U	10	22	759	670
257	ML5528	M	O	10	22	697	610
257	ML5835	M	O	10	22	699	540
257	ML5834	M	O	10	22	699	610
257	ML5407	U	U	8	18,5	700	320
258	ML5836	T1	T1	8	18,5	639	465
259	ML5450	U	U	8	18,5	635	290
259	ML6294	P	C1	8	18,5	647	275
260	ML5820	U	U	8	18,5	613	300
260	ML5593	Y1	D	8	18,5	615	400
260	ML5432	S1	S1	8	18,5	624	400
260	ML5530	U	P	8	18,5	640	510
260	ML6297	U	U	10	22	650	690
260	ML6298	U	U	10	22	650	745
260	ML5452	U	U	8	18,5	653	460
260	ML5435	S1	S1	8	18,5	656	400
260,5	ML6055	U	U	10	22	661,5	800
265	ML5851	S1	S1	8	18,5	631	455
265	ML6003	U	P	8	18,5	644	300
265	ML5267	S1	S1	8	18,5	648	190
265	ML5470	S1	S1	8	18,5	685	200
269	ML5282	U	U	8	18,5	630	330
270	ML6211	S1	S3	8	18,5	648	260
270	ML5345	U	U	8	18,5	650	310
270	ML5715	U	C1	8	18,5	650	350
270	ML5521	T1	Q	8	18,5	665	360
270	ML5589	S1	S1	8	18,5	671,5	360
270	ML5393	U	U	8	18,5	678	270
270	ML5192	U	U	8	18,5	680	360
270	ML5634	T1	T1	8	18,5	680	360
270	ML5508	T1	T1	8	18,5	680	390
271	ML6074	U	Q	8	18,5	663,5	315
272	ML5795	U	U	8	18,5	628	440
272	ML5543	U	U	8	18,5	695	640
274	ML5631	T1	T1	8	18,5	677	340
275	ML5418	U	U	8	18,5	645,5	450
275	ML5603	Y1	D	8	18,5	650	310
275	ML5605	S1	D	8	18,5	650	310
275	ML5654	U	U	8	18,5	657	480
275	ML6072	U	U	8	18,5	664	265
275	ML5162	S1	S1	8	18,5	666,5	390
275	ML5315	U	U	8	18,5	675	440
276	ML6288	U	C1	8	18,5	660	500
276	ML5976	N	N	8	18,5	673	250
277	ML6039	T1	T1	10	22	742	400
278	ML5022	Y1	X1	8	18,5	696	220
279	ML5608	N	N	8	18,5	675	210
280	ML6342	P	C1	8	18,5	662	350
280	ML5333	Y1	D	8	18,5	668	375
280	ML6343	P	C1	8	18,5	681	320
280	ML6096	P	U	8	18,5	690	380
280	ML5128	S1	S1	10	22	690	630

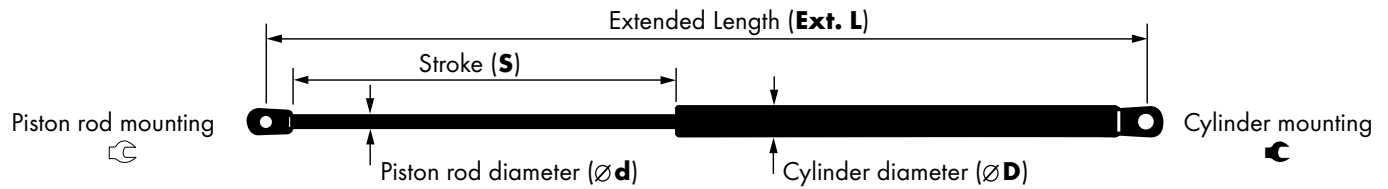

S	Monroe®	↺	↻	Ød	ØD	Ext. L	F1
280	ML5750	U	U	10	22	720	870
280	ML5051	S1	E1	10	22	726	420
280	ML6156	13	44	8	19	740,5	210
282	ML6296	S1	S3	8	18,5	611	480
282	ML5295	U	U	8	18,5	678	480
282	ML6168	13	44	8	19	703	530
285	ML5309	U	U	8	18,5	675	260
285	ML5268	U	U	8	18,5	685	180
285	ML5337	U	U	8	18,5	691,5	270
286	ML6365	P	C1	8	18,5	724	340
291	ML6284	P	C1	8	18,5	746	200
293	ML5798	U	U	8	18,5	674	300
293	ML5799	U	U	8	18,5	674	330
294	ML6111	S1	C1	8	18,5	694	220
295	ML6231	U	U	8	18,5	686	700
295	ML5561	U	U	8	18,5	687	270
295	ML5499	Y1	D	8	18,5	700	345
295	ML5494	Y1	D	8	18,5	700	400
300	ML5837	T1	T1	8	18,5	690	630
300	ML5037	U	P	8	18,5	700	325
300	ML5057	P	S1	8	18,5	700	325
300	ML5113	T1	T1	8	18,5	700	670
300	ML5737	P	U	8	18,5	720	180
300	ML5892	S1	S1	8	18,5	830	560
303	ML5565	P	S1	8	18,5	715	160
304	ML6368	P	C1	8	18,5	693	145
306	ML5269	P	U	8	18,5	715	290
306	ML5266	U	C1	8	18,5	722	280
306	ML5679	L	L	8	18,5	722	310
307	ML5516	T1	T1	10	22	905	730
307	ML5550	T1	T1	10	22	905	730
310	ML5758	P	U	8	18,5	726,5	360
310	ML5648	P	U	8	18,5	728	265
310	ML6079	P	U	8	18,5	728	315
310	ML5829	P	U	8	18,5	730	380
310	ML5709	U	U	10	22	736,5	725
310	ML5790	P	S1	8	18,5	740	290
313	ML6049	U	U	8	18,5	721,5	180
315	ML5768	U	U	8	18,5	721,5	350
315	ML5386	U	U	8	18,5	722	325
315	ML6254	P	C1	8	18,5	730	210
315	ML5368	S1	S1	8	18,5	750	300
316	ML5726	U	U	8	18,5	730	140
320	ML5735	P	U	8	18,5	730	250
321	ML5738	P	U	8	18,5	735	300
322	ML6185	13	44	8	19	734	320
322	ML5329	U	U	10	22	772	630
322	ML5328	U	U	10	22	775	530
322	ML5621	U	U	10	22	775	530
324	ML5638	U	U	8	18,5	765	200
325	ML5409	U	U	8	18,5	765	235
326	ML6323	S1	S3	8	18,5	736	315
335	ML5741	U	U	8	18,5	765	340
340	ML5514	U	U	10	22	850	670
342	ML5102	Y1	V	8	18,5	788	280
350	ML5074	F1	Y3	10	22	798	500
350	ML6309	U	C1	8	18,5	810	280
350	ML5448	U	U	10	22	866	370
360	ML6221	P	C1	8	18,5	779	285
370	ML5584	S1	U	10	22	870	370
380	ML5385	U	X1	10	22	885	410
404	ML6032	U	13	10	22	874	260
417	ML5678	U	L	10	22	943	380
110/120	ML6317	U	C1	8	18,5	380	310

S	Monroe®	↺	↻	Ød	ØD	Ext. L	F1
162/230	ML6364	P	C1	8	18,5	615	265
175/197	ML6320	U	C1	8	18,5	483	440
195/260	ML6209	U	U	10	22	655	770
200/225	ML6339	S1	S3	8	18,5	512	310
210/250	ML6303	U	C1	8	18,5	565	360
95/108	ML6222	U	C1	8	18,5	295	380

MOUNTING TYPES

MOUNTING

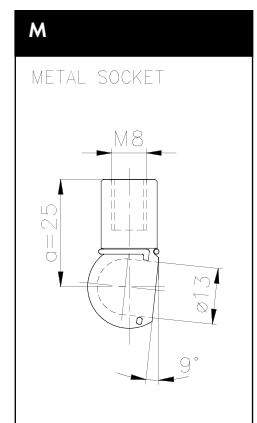
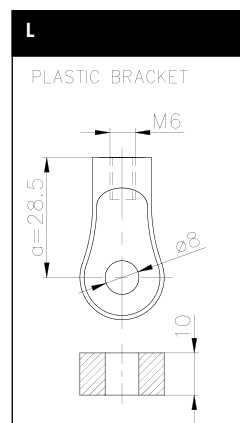
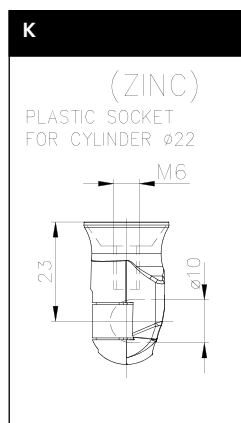
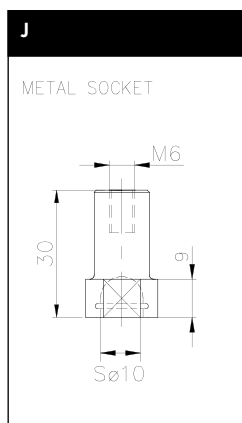
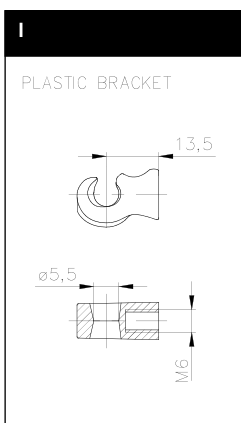
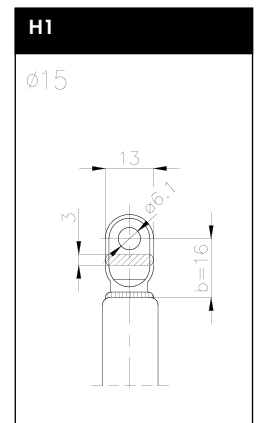
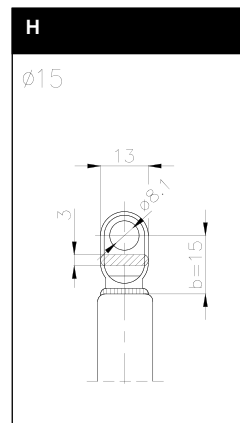
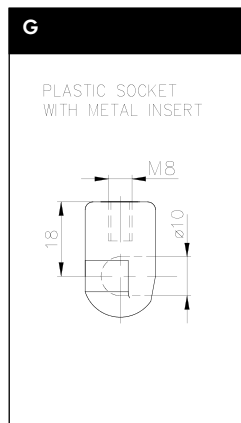
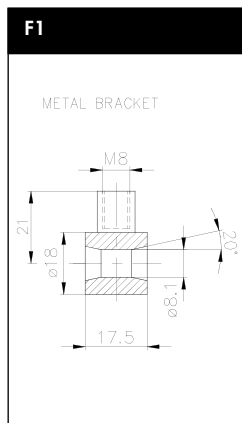
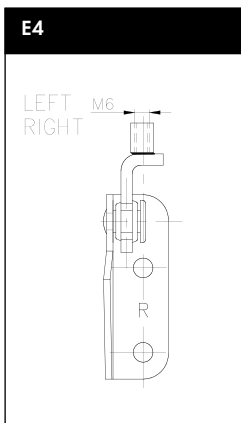
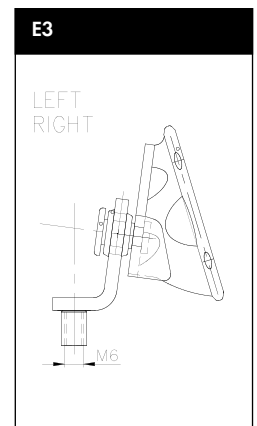
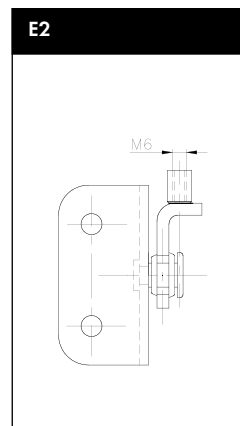
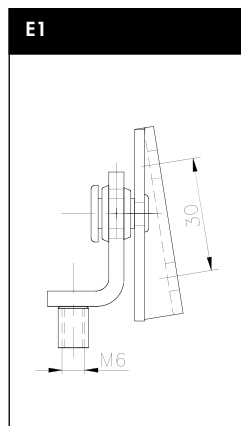
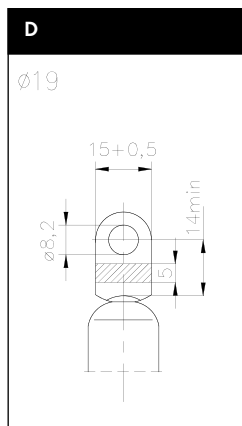
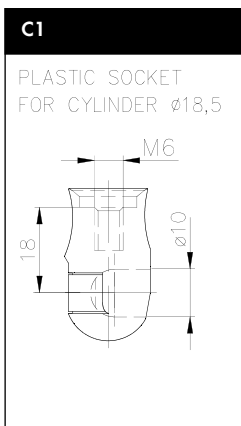
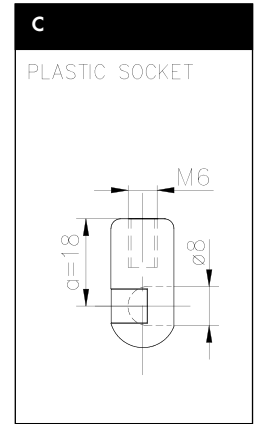
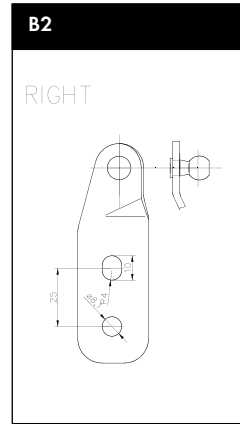
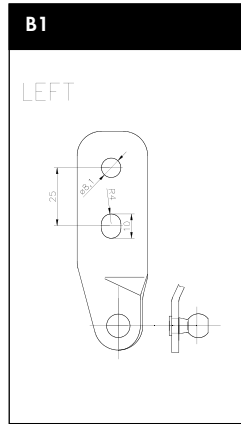
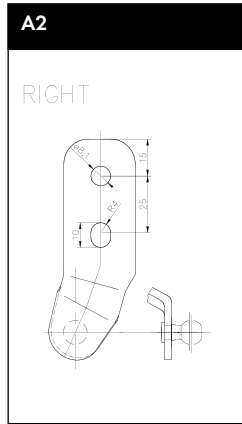
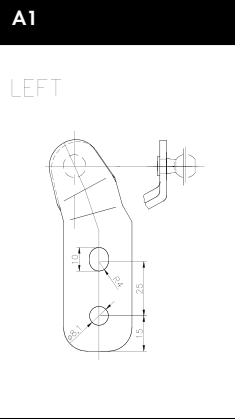

MOUNTING TYPES

MOUNTING

<p>Z</p> <p>METAL SOCKET</p>	<p>O</p> <p>METAL SOCKET</p>	<p>P</p> <p>PLASTIC SOCKET</p>	<p>Q</p>	
<p>R</p> <p>METAL BRACKET</p>	<p>S1</p> <p>(ZINC L) PLASTIC SOCKET</p>	<p>S2</p> <p>METAL SOCKET</p>	<p>S3</p> <p>PLASTIC SOCKET</p>	<p>T1</p> <p>METAL SOCKET</p>
<p>U</p> <p>PLASTIC SOCKET</p>	<p>V</p>	<p>W</p>	<p>X1</p>	<p>X2</p>
<p>X3</p>	<p>Y1</p> <p>METAL BRACKET</p>	<p>Y2</p> <p>METAL BRACKET</p>	<p>Y3</p> <p>METAL BRACKET</p>	<p>Y4</p> <p>METAL BRACKET</p>

MOUNTING TYPES

MOUNTING

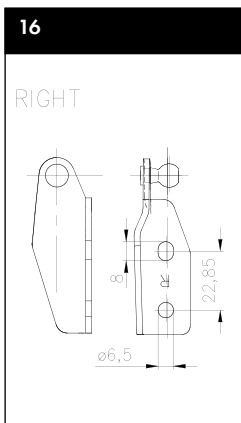
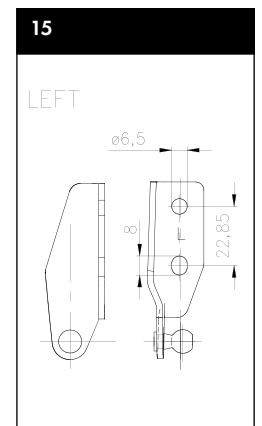
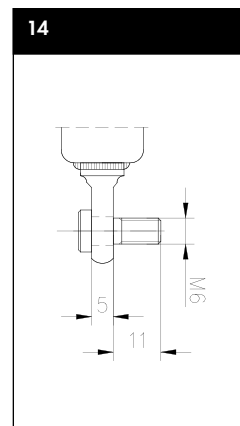
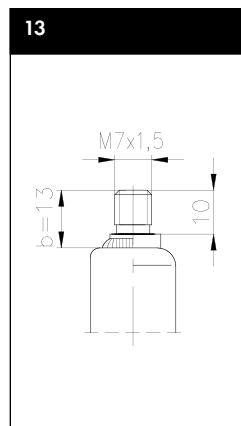
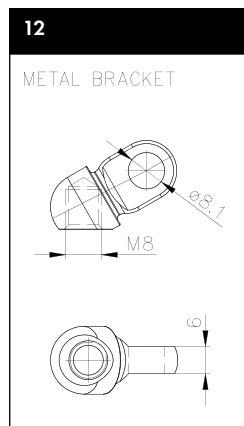
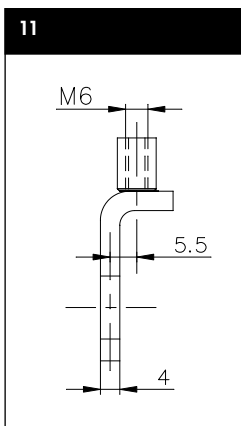
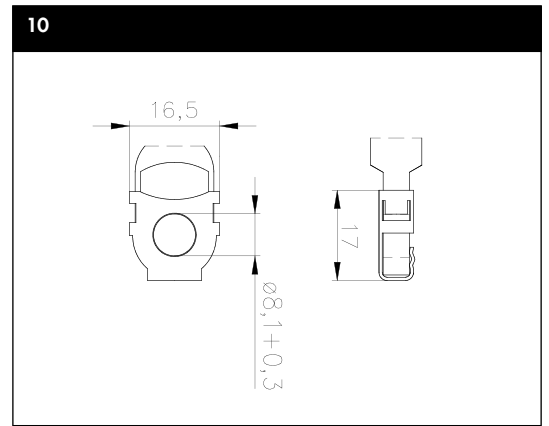
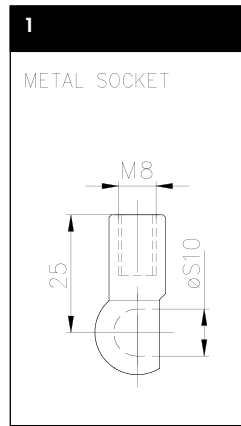
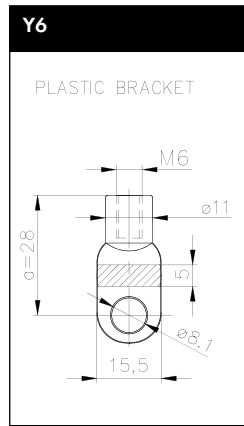
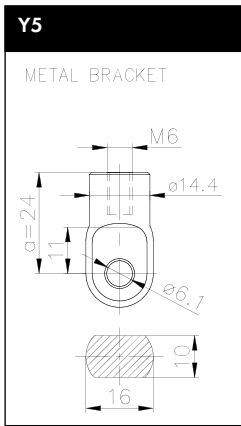

GAS SPRINGS ON DEMAND

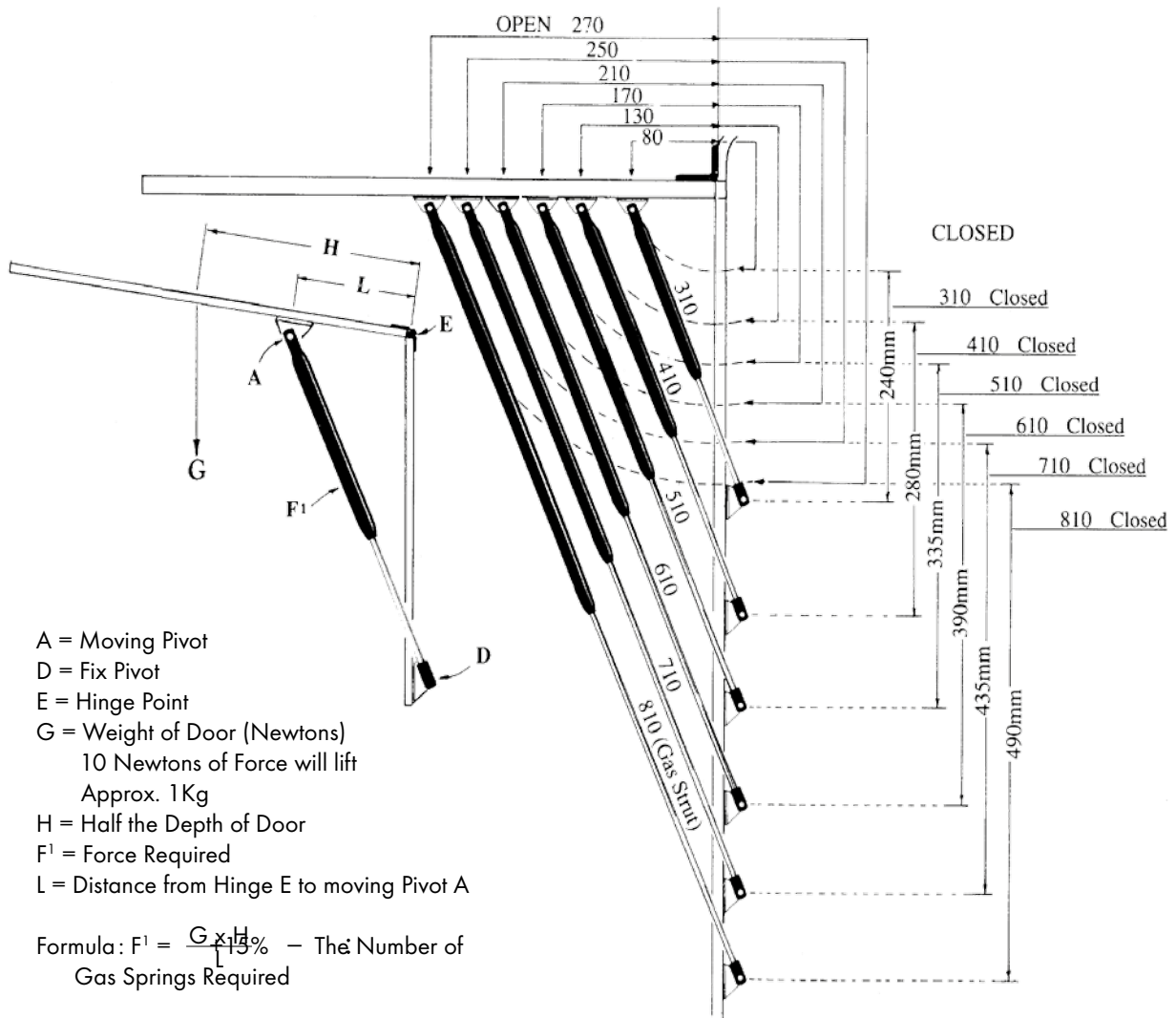

Special Note.

By reducing the measurement from Point A to Hinge Point E by 20mm, this will give you an extra 10° (degrees) lift.

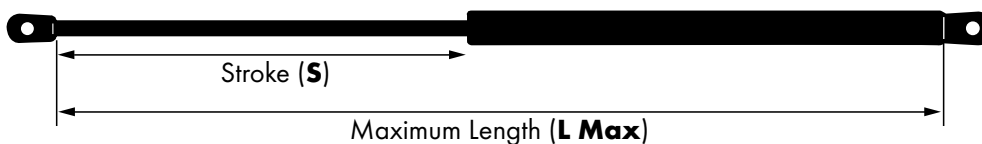

BUILD TO ORDER - REQUEST FORM

Monroe® may be able to fulfill your need for special order applications.
Use the following form to prepare information and accurate data.
Please send this form to your  representative

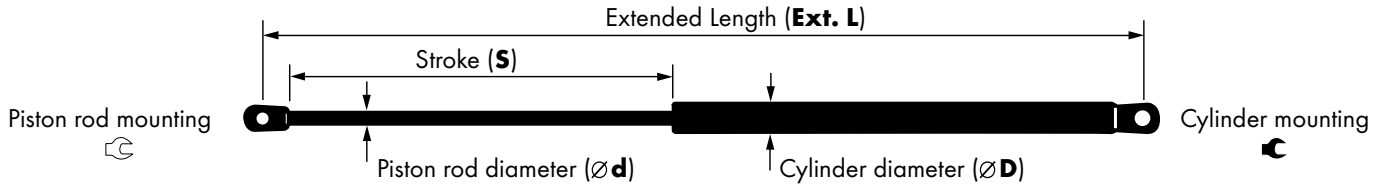

Piston rod mounting	SPECIFICATIONS		Cylinder mounting
	OE N°		
	Ød / ØD:	6/15 mm	
		8/19 mm	
		10/22 mm	
		14/28 mm	
	Ext. L mm	
	S mm	
	F1 N	
Annual Volumes			
Packaging Type	Carton box		
	Plastic bag		
	Bulk		

CUSTOMER INFORMATION

Company name: _____ Phone: _____
 Name: _____ Mobile: _____
 Street: _____ Email: _____
 Zip code: _____
 City: _____
 Country: _____

Warranty Terms

(valid in Europe only)

**MONROE® Europe warrants the listed
MONROE® products to the original retail purchaser
against functional and/or material defects:**



**MONROE® OESpectrum
MONROE® OESpectrum Springs**

*Limited warranty. Terms and Conditions apply.
Available on www.monroe-oespectrum.com



**MONROE® Adventure
MONROE® Gas-Magnum
MONROE® Level-Light
MONROE® Load-Leveler
MONROE® Magic Camber
MONROE® Magnum**

**MONROE® Max Lift
MONROE® Mounting Kit
MONROE® Original
MONROE® Protection Kit
MONROE® Ride-Leveler
MONROE® RoadMatic**

**MONROE® Sensa-Trac
MONROE® Spheres
MONROE® Springs
MONROE® Suspension parts
MONROE® Van-Magnum**

MONROE® Europe provides a 2 year warranty without mileage limitation.

(5 year warranty for MONROE® OESpectrum Springs)

The Warranty of MONROE® Europe is limited to the delivery of a new MONROE® product.

All claims are first handled by the MONROE® distributor and then honoured by MONROE®.

The reseller/installer will provide the MONROE® distributor with all relevant information such as:

- consumer's name and address
- fitting or sales dates
- MONROE® product part number
- vehicle identification data
- proof of purchase documents
- description of the defect.

Excluded from warranty are:

1. Regular wear-out.
2. MONROE® products fitted contrary to application information in the MONROE® catalogue or its subsequent amendments.
3. MONROE® products which have been modified or damaged by incorrect mounting or incorrect use of the vehicle, contrary to the car manufacturers' specifications or MONROE®'s.
4. MONROE® products damaged by mounting on another car than indicated in the MONROE® catalogue or its subsequent amendments.
5. Shock absorbers with damaged piston rod or damaged oil seal due to holding the piston rod with a wrench or pliers instead of the correct tool.
6. Premature wear-out caused by re-use of damaged mounting parts such as: rubber dirt shields, damaged bump stops, etc.
7. Damages caused by an accident.
8. MONROE® products damaged while used in rally or racing sports.
9. Ride-Levelers with air sleeve abrasion caused by incorrect mounting.
10. Reconditioned or recycled MONROE® products.
11. Defects caused by lack of maintenance or maintenance wrongly executed on the vehicle.

In addition: All MONROE® products are developed and manufactured according to original suspension specifications from car manufacturers. MONROE® indicates in its catalogue the originally lowered models on which its products fit.

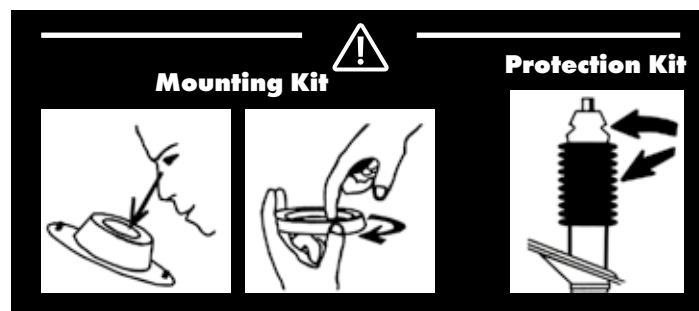
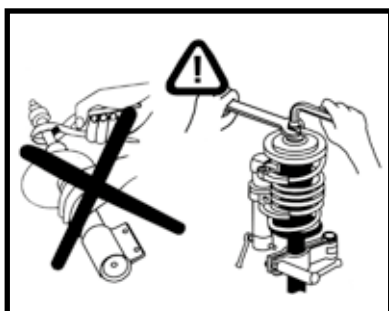

Garantie

(gilt nur für Europa)

Bei Materialschäden und/oder Funktionsfehlern übernimmt **MONROE® Europe** gegenüber den Vertragshändlern für die im folgenden aufgeführten **MONROE®-Produkte** die **Garantie**:



MONROE® OESpectrum
MONROE® OESpectrum Springs

*Limited warranty. Terms and Conditions apply.
Available on www.monroe-oespectrum.com



MONROE® Adventure
MONROE® Gas-Magnum
MONROE® Level-Light
MONROE® Load-Leveler
MONROE® Magic Camber
MONROE® Magnum

MONROE® Max Lift
MONROE® Mounting Kit
MONROE® Original
MONROE® Protection Kit
MONROE® Ride-Leveler
MONROE® RoadMatic

MONROE® Sensa-Trac
MONROE® Spheres
MONROE® Springs
MONROE® Suspension parts
MONROE® Van-Magnum

MONROE® Europe übernimmt eine zweijährige Garantie ohne Kilometerbegrenzung.
(5 Jahre Garantie auf MONROE® OESpectrum Springs)

Die Garantie von MONROE® Europe beschränkt sich auf die Lieferung eines neuen MONROE® Produktes.

Alle Garantieansprüche werden zuerst vom MONROE®-Werksvertreter bearbeitet und dann von MONROE® abgewickelt.

Der Weiterverkäufer/Einbaubetrieb übermittelt dem MONROE®-Werksvertreter alle zweckdienlichen Informationen wie:

- Kundenname und Anschrift
- Einbau- oder Verkaufsdatum
- MONROE® Artikelnummer
- Kfz-Daten
- Kaufbeleg
- Beschreibung des Defekts.

Von der Garantie ausgeschlossen sind:

1. Normale Abnutzung.
2. eingebaute MONROE® Produkte, bei denen die korrekte Zuordnung im MONROE® Katalog oder seiner Nachträge nicht beachtet wurde.
3. MONROE® Produkte, welche verändert oder beschädigt wurden aufgrund von Einbaufehlern oder inkorrektem Fahrzeugeinsatz, im Gegensatz zu den Spezifikationen der Fahrzeughersteller oder MONROE®.
4. MONROE® Produkte, die beschädigt wurden aufgrund Einbaus in einem anderen als im MONROE® Katalog oder seiner Nachträge zugeordneten Fahrzeugs.
5. Stoßdämpfer, deren Kolbenstange oder Öldichtung statt mit dem dafür vorgesehenen Werkzeug mit einem Schraubenschlüssel oder einer Zange gehalten und damit beschädigt wurden.
6. Vorzeitiger Verschleiß aufgrund der Wiederverwendung von beschädigten Befestigungselementen wie Gummi-Schutzbälgen, beschädigten Anschlagpuffern usw.
7. Beschädigungen aufgrund eines Unfalls.
8. MONROE® Produkte, die beschädigt wurden aufgrund Einsatz im Rallye- oder Rennsport.
9. Abschleiß der Luftmanschette des Ride-Levelers, verursacht durch unsachgemäßen Einbau.
10. Von einem Drittanbieter – nicht von MONROE® oder einem seiner Lizenznehmer – überholte oder wiederaufgearbeitete Stoßdämpfer.
11. Defekte, die als Folgeschaden anderer falsch verwendeter oder beschädigter Komponenten im Fahrzeug herrühren.

Außerdem: Alle Produkte von MONROE® werden nach den technischen Spezifikationen der Autohersteller für die Originalradaufhängung entwickelt und gefertigt. Im MONROE®-Katalog ist genau angegeben, für welche tiefergelegten Originalmodelle MONROE®-Produkte passen.

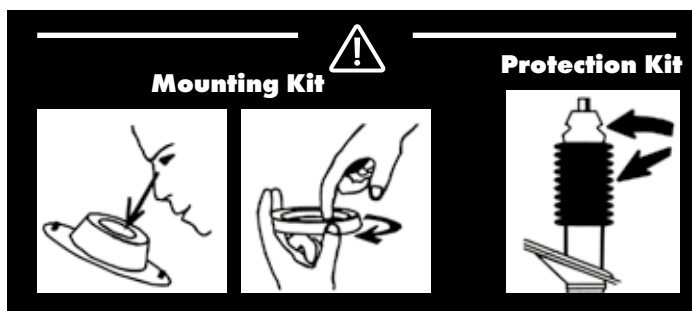
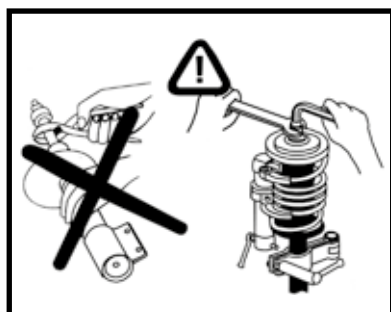

Términos de la Garantía

m

(válida sólo en Europa)

MONROE® Europa facilita una garantía que cubre sus productos contra defectos funcionales y/o de materiales.



MONROE® OESpectrum
MONROE® OESpectrum Springs

*Limited warranty. Terms and Conditions apply.
Available on www.monroe-oespectrum.com



MONROE® Adventure
MONROE® Gas-Magnum
MONROE® Level-Light
MONROE® Load-Leveler
MONROE® Magic Camber
MONROE® Magnum

MONROE® Max Lift
MONROE® Mounting Kit
MONROE® Original
MONROE® Protection Kit
MONROE® Ride-Leveler
MONROE® RoadMatic

MONROE® Sensa-Trac
MONROE® Spheres
MONROE® Springs
MONROE® Suspension parts
MONROE® Van-Magnum

MONROE® Europa ofrece 2 años de garantía sin límite de kilometraje.

(5 años para el MONROE® OESpectrum Springs)

La Garantía de MONROE® Europa se limita al suministro de productos nuevos MONROE®.

Todas las reclamaciones se efectuarán a través del distribuidor MONROE®, y serán satisfechas por MONROE®.

El vendedor/instalador proporcionará al distribuidor autorizado toda la información pertinente:

- nombre y dirección del consumidor
- fecha de instalación o venta
- Referencia de producto MONROE®
- identificación del vehículo
- comprobantes de la adquisición
- descripción del defecto.

Quedan excluidos de la garantía:

1. El desgaste normal del amortiguador.
2. Productos MONROE® montados sin hacer caso a la información especificada sobre aplicación en el catálogo MONROE® o en sus posteriores modificaciones.
3. Productos MONROE® que han sido modificados o dañados por un montaje incorrecto o uso incorrecto del vehículo, no siguiendo las especificaciones del fabricante del vehículo o de MONROE®.
4. Productos MONROE® dañados por haber sido montados en un vehículo diferente al indicado en el catálogo MONROE® o sus posteriores modificaciones.
5. Los amortiguadores con el vástago del pistón o el retén de aceite deteriorados debido a que dicho vástago se sujetó con unos alicates, y no con la herramienta adecuada para tal fin.
6. El desgaste prematuro causado por volver a usar piezas de montaje desgastadas o deterioradas tales como: el conjunto, limitador de carrera en compresión + cubre-polvos de caucho (Protection Kit) y el cojinete de torreta superior (Mounting Kit).
7. Los daños causados por un accidente.
8. Productos MONROE® dañados durante el uso del vehículo en un rally u otro deporte de competición.
9. Los Ride-Levelers que presenten abrasión en el fuelle de caucho que hace las veces de amortiguador neumático debido a un uso o montaje incorrecto.
10. Productos MONROE® reciclados o reacondicionados.
11. Los defectos provocados por la falta de mantenimiento o por errores en el mantenimiento del vehículo.

Además: Todos los productos de MONROE® están desarrollados y fabricados según las especificaciones para equipos de suspensión establecidas por los fabricantes de automóviles. MONROE® incluye en este catálogo los modelos con suspensiones rebajadas de origen en los que sus productos pueden instalarse.

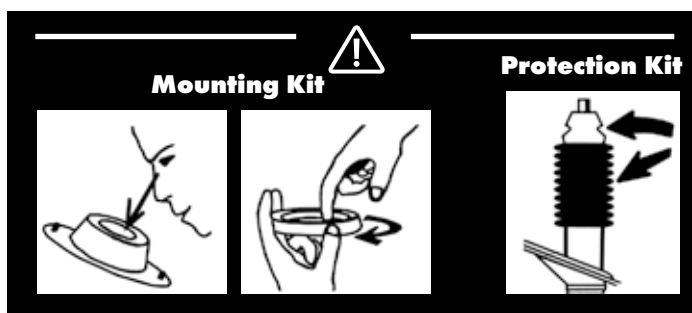
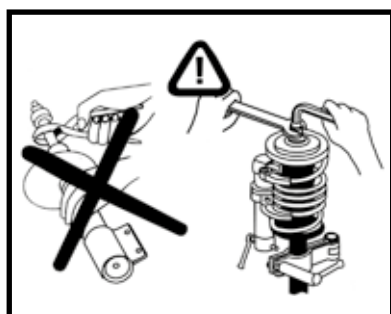

Clauses de Garantie

(valable uniquement en Europe)

MONROE® Europe garantit au client final ses produits contre tous défauts de fabrication et/ou de fonctionnement.



**MONROE® OESpectrum
MONROE® OESpectrum Springs**

*Limited warranty. Terms and Conditions apply.
Available on www.monroe-oespectrum.com



**MONROE® Adventure
MONROE® Gas-Magnum
MONROE® Level-Light
MONROE® Load-Leveler
MONROE® Magic Camber
MONROE® Magnum**

**MONROE® Max Lift
MONROE® Mounting Kit
MONROE® Original
MONROE® Protection Kit
MONROE® Ride-Leveler
MONROE® RoadMatic**

**MONROE® Sensa-Trac
MONROE® Spheres
MONROE® Springs
MONROE® Suspension parts
MONROE® Van-Magnum**

MONROE® Europe assure une garantie de 2 ans sans limitation de kilométrage, à compter de la date de facture constatant l'achat (5 ans sur la gamme MONROE® OESpectrum Springs)

La Garantie MONROE® Europe est limitée à la livraison d'un nouveau produit MONROE®.

L'exercice du droit à la garantie est soumis au respect absolu des dispositions propres à sa mise en oeuvre.

Le vendeur / installateur devra fournir au distributeur MONROE® l'ensemble des informations suivantes :

- Nom et adresse du client final
- Dates de vente et de montage
- Référence précise du produit MONROE®
- Identification du véhicule
- Preuves d'achat
- Description du défaut

Ne sont pas couverts par la garantie :

1. L'usure normale.
2. Montage des Produits MONROE® non conformes aux spécificités de l'application indiquées dans le catalogue MONROE®, ou de ses conséquences ultérieures.
3. Produits MONROE® ayant été modifiés ou endommagés par un montage incorrect ou une utilisation non appropriée du véhicule, non-conforme au cahier des charges constructeur ou de MONROE®.
4. Produits MONROE® endommagés par un montage sur un autre véhicule que celui indiqué dans le catalogue MONROE®, ou ses conséquences ultérieures.
5. Les amortisseurs dont la tige ou le joint ont été endommagés du fait de l'utilisation d'outillage non adéquat.
6. L'usure prématurée due à une réutilisation d'éléments d'assemblage endommagés : soufflet de protection en caoutchouc, butées d'amortisseur abîmées, etc.
7. Les dommages dus à un accident.
8. Produits MONROE® endommagés lors d'utilisation en rallye ou en courses sportives.
9. Les dispositifs de correction d'assiette dont le soufflet présente une usure anormale due à un montage non conforme.
10. Produits MONROE® reconditionnés ou recyclés.
11. Les défauts dus à un entretien insuffisant ou exécuté de manière non conforme sur le véhicule.

En outre : Tous les produits MONROE® sont développés et fabriqués conformément aux cahiers des charges d'origine des suspensions, fournis par les constructeurs automobiles. Les modèles surbaissés d'origine, sur lesquels peuvent être installés les produits MONROE®, sont spécifiés dans le catalogue.

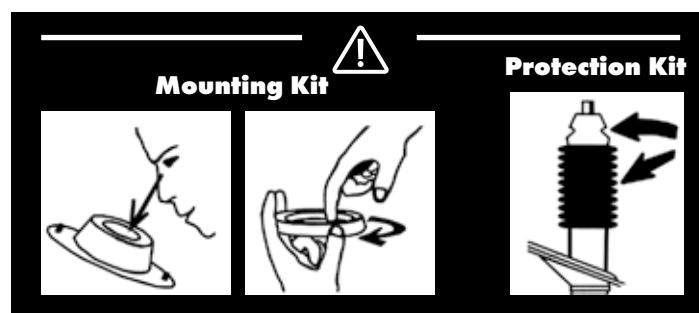
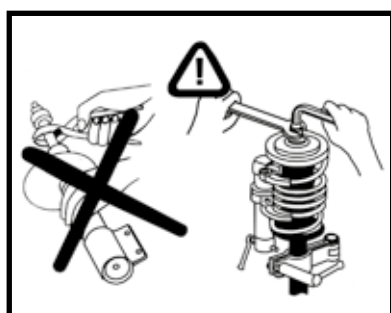

Condizioni di Garanzia

(Valida solo per l'Europa)

La **MONROE®** Europa garantisce i suoi prodotti
contro ogni difetto di fabbricazione:



MONROE® OESpectrum
MONROE® OESpectrum Springs

*Limited warranty. Terms and Conditions apply.
Available on www.monroe-oespectrum.com



MONROE® Adventure
MONROE® Gas-Magnum
MONROE® Level-Light
MONROE® Load-Leveler
MONROE® Magic Camber
MONROE® Magnum

MONROE® Max Lift
MONROE® Mounting Kit
MONROE® Original
MONROE® Protection Kit
MONROE® Ride-Leveler
MONROE® RoadMatic

MONROE® Sensa-Trac
MONROE® Spheres
MONROE® Springs
MONROE® Suspension parts
MONROE® Van-Magnum

La **MONROE®** Europa offre una garanzia di due anni con chilometraggio illimitato
(garanzia di tre anni per **MONROE® OESpectrum Springs**)

La garanzia della **MONROE®** Europa è limitata alla consegna di un nuovo prodotto **MONROE®**.

Tutti i reclami vanno presentati ai distributori della **MONROE®** e saranno successivamente soddisfatti dal distributore stesso.

Il rivenditore/installatore fornirà al distributore **MONROE®** tutte le informazioni inerenti, quali:

- nome e indirizzo dell'utente
- data di vendita o di installazione
- numero di partita prodotti **MONROE®**
- dati di riconoscimento del veicolo
- documenti e prova d'acquisto
- descrizione del difetto.

La garanzia non comprende:

1. L'usura normale.
2. Prodotti **MONROE®** installati al contrario di come indicato nel catalogo o sue appendici
3. Prodotti **MONROE®** che sono stati alterati o danneggiati da una installazione non appropriata o da un uso del veicolo non conforme alle specifiche fornite dal costruttore della vettura o da **MONROE®**
4. Prodotti **MONROE®** danneggiati a causa del montaggio su una vettura diversa da quella indicata nel catalogo **MONROE®** o nei suoi addendum.
5. Gli ammortizzatori con stelo del pistone o con paraolio danneggiati in seguito all'utilizzo di attrezzi non adatti in fase di montaggio.
6. L'usura precoce causata dal riutilizzo di parti di assemblaggio danneggiate, come ad esempio i parapolvere in gomma, il dado autobloccante, ecc.
7. I danni causati da incidenti.
8. Prodotti **MONROE®** danneggiati a causa di un uso non appropriato o sportivo.
9. I Ride-Levelers con abrasione dei manicotti per l'aria, dovuta ad un errato montaggio.
10. Prodotti **MONROE®** ricondizionati o riciclati
11. I danni dovuti ad una manutenzione insufficiente o non corretta del veicolo.

Inoltre: Tutti i prodotti **MONROE®** sono sviluppati e fabbricati conformemente alle specifiche relative alle sospensioni originali fornite dai costruttori di auto. Nel catalogo **MONROE®** sono indicati i modelli ribassati in origine sui quali è possibile installare i prodotti **MONROE®**.

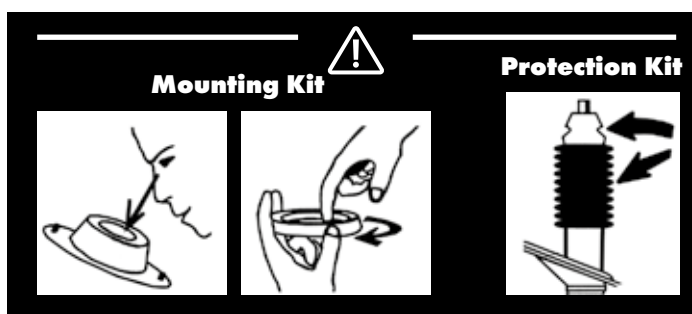
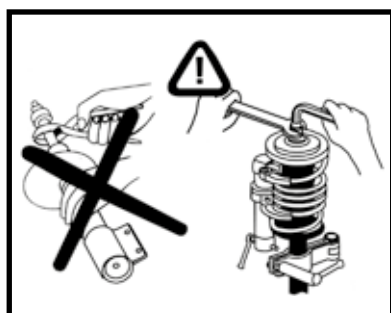

Condições de Garantia

(válidas apenas na Europa)

Os produtos MONROE® incluídos na lista para o retalhista original têm a garantia da MONROE® Europa contra defeitos do material e/ou de funcionamento.



MONROE® OESpectrum
MONROE® OESpectrum Springs

*Limited warranty. Terms and Conditions apply.
Available on www.monroe-oespectrum.com



MONROE® Adventure
MONROE® Gas-Magnum
MONROE® Level-Light
MONROE® Load-Leveler
MONROE® Magic Camber
MONROE® Magnum

MONROE® Max Lift
MONROE® Mounting Kit
MONROE® Original
MONROE® Protection Kit
MONROE® Ride-Leveler
MONROE® RoadMatic

MONROE® Sensa-Trac
MONROE® Spheres
MONROE® Springs
MONROE® Suspension parts
MONROE® Van-Magnum

A MONROE® Europa dá uma garantia de dois anos sem limitação de quilometragem (5 anos para o MONROE® OESpectrum Springs)

A garantia de MONROE® Europa limita-se à entrega de um novo produto MONROE®.

Todas as reclamações são primeiramente tratadas pelo distribuidor MONROE® e, seguidamente, honradas pela MONROE®.

O revendedor/ instalador fornecerá ao distribuidor MONROE® todas as informações necessárias designadamente:

- o nome e a morada do consumidor
- a data de aplicação ou de venda
- Referência do produto MONROE®
- os dados identificativos do veículo
- o comprovante do documento de compra
- a descrição do defeito.

Excluem-se da garantia:

1. Desgaste regular.
2. Produtos MONROE® instalado em contradição com as informações prestadas pelo catálogo MONROE® e suas actualizações posteriores.
3. Produtos MONROE® que foram alterados ou danificados pelo uso, ou montagem, incorreta no veículo e em contradição com as especificações dos fabricantes de automóveis, ou da MONROE®.
4. Produtos MONROE® danificados por montagem em viatura diferente da indicada no catálogo MONROE® ou por actualizações posteriores.
5. Amortecedores com hastes de pistão danificadas ou vedante de óleo danificado devido à utilização de chave inglesa ou alicate em vez da ferramenta adequada.
6. O desgaste prematuro provocado pela reciclagem de peças sobressalentes danificadas, designadamente: protecção de borracha, batentes dos amortecedores, etc.
7. Danos provocados por acidente.
8. Produtos MONROE® danificados quando usados em rally ou eventos desportivos.
9. Niveladores com abrasão provocada por montagem incorrecta.
10. Produtos MONROE® reconicionados ou reciclados.
11. Defeitos causados pela ausência de manutenção ou pela manutenção incorrecta do veículo.

E ainda: Todos os produtos da MONROE® são desenvolvidos e fabricados em conformidade com as especificações de origem dos fabricantes de automóveis. A MONROE® indica no seu catálogo os modelos com suspensões rebaixasadas de origem nos quais os seus produtos são aplicáveis.

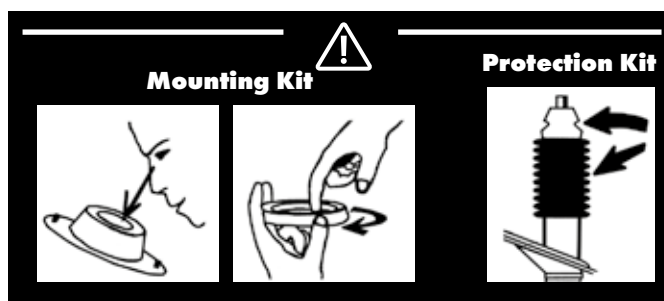
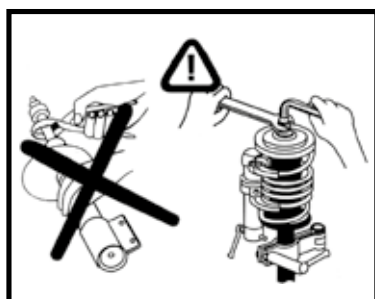

Warunki Gwarancji

(ważne wyłącznie w Europie)

MONROE® Europe gwarantuje odpowiedzialność wobec pierwotnego nabywcy detalicznego za wady eksploatacyjne lub materiałowe wyrobów objętych wykazem.



**MONROE® OESpectrum
MONROE® OESpectrum Springs**

*Limited warranty. Terms and Conditions apply.
Available on www.monroe-oespectrum.com



**MONROE® Adventure
MONROE® Gas-Magnum
MONROE® Level-Light
MONROE® Load-Leveler
MONROE® Magic Camber
MONROE® Magnum**

**MONROE® Max Lift
MONROE® Mounting Kit
MONROE® Original
MONROE® Protection Kit
MONROE® Ride-Leveler
MONROE® RoadMatic**

**MONROE® Sensa-Trac
MONROE® Spheres
MONROE® Springs
MONROE® Suspension parts
MONROE® Van-Magnum**

MONROE® Europe zapewnia 2-letnią gwarancję bez ograniczenia przebiegu.
(5-letnia gwarancja na MONROE® OESpectrum Springs)

Gwarancja MONROE® Europe ograniczona jest do zakupu nowego amortyzatora produkt MONROE®.

Wszelkie reklamacje z tytułu gwarancji muszą być zgłoszone najpierw do dystrybutora MONROE®, zanim będą honorowane przez MONROE®.

Sprzedawca lub instalujący amortyzatory dostarczy dystrybutorowi wszelkich wymaganych informacji, takich jak:

- nazwisko i adres klienta
- dane identyfikacyjne samochodu
- data instalacji lub sprzedaży
- kopię dokumentu zakupu
- MONROE® numer referencyjny
- opis wady.

Gwarancja nie obejmuje:

1. Normalnego zużycia.
2. Produkty MONROE® zamontowane niezgodnie z zaleceniami w katalogu MONROE®, lub też w późniejszych informacjach.
3. Produkty MONROE®, które zostały zmodyfikowane lub uszkodzone w wyniku nieprawidłowego montażu lub niewłaściwego użytkowania pojazdu, niezgodnie z zaleceniami producentów samochodów lub firmy MONROE®.
4. Produkty MONROE® uszkodzone przez montaż w niewłaściwym pojeździe niż wskazany w katalogu MONROE®, lub też w późniejszych informacjach.
5. Amortyzatorów, których tłoczysko lub uszczelnienie olejowe zostało uszkodzone, ponieważ do przytrzymania amortyzatora użyto klucza lub kleszczy zamiast wskazanego narzędzia montażowego.
6. Przedwczesnego zużycia spowodowanego przez ponowne wykorzystanie uszkodzonych elementów montażowych.
7. Uszkodzeń powstałych na skutek wypadku.
8. Produkty MONROE® uszkodzone w wyniku użytkowania w sportach rajdowych i wyścigowych.
9. Amortyzatorów Ride-Leveler z uszkodzeniami pneumatycznej osłony, spowodowanymi niewłaściwym montażem.
10. Produkty MONROE® regenerowane
11. Uszkodzeń spowodowanych brakiem konserwacji lub niewłaściwą konserwacją pojazdu.

Dodatkowo: Wszystkie produkty firmy MONROE® są opracowywane i produkowane zgodnie z oryginalnymi specyfikacjami zawieszenia pochodzącymi od producentów samochodów. W katalogu zaznaczone są modele z fabrycznie obniżonym zawieszeniem, do których pasują produkty firmy MONROE®.

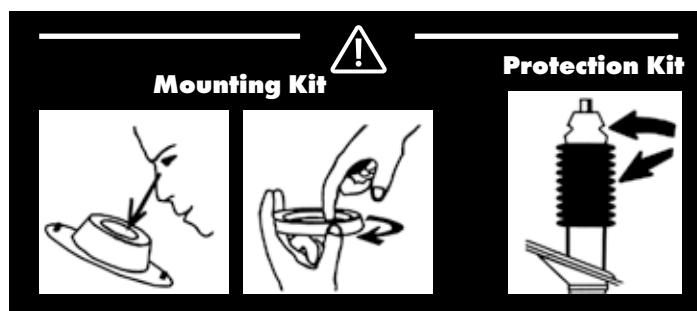
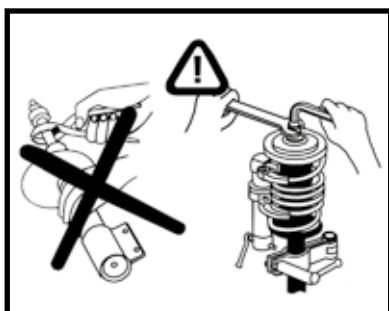

Условия гарантии

(действительны только в странах Европейского Союза)

В случае обнаружения функциональных или физических дефектов MONROE® Europe обеспечивает гарантию реальному розничному покупателю на изделия MONROE®, перечисленные ниже:



**MONROE® OESpectrum
MONROE® OESpectrum Springs**

*Limited warranty. Terms and Conditions apply.
Available on www.monroe-oespectrum.com



**MONROE® Adventure
MONROE® Gas-Magnum
MONROE® Level-Light
MONROE® Load-Leveler
MONROE® Magic Camber
MONROE® Magnum**

**MONROE® Max Lift
MONROE® Mounting Kit
MONROE® Original
MONROE® Protection Kit
MONROE® Ride-Leveler
MONROE® RoadMatic**

**MONROE® Sensa-Trac
MONROE® Spheres
MONROE® Springs
MONROE® Suspension parts
MONROE® Van-Magnum**

MONROE® Europe обеспечивает гарантию 2 года без ограничения пробега.

(5 года гарантии для MONROE® OESpectrum Springs)

Гарантийные обязательства MONROE® Europe распространяются лишь на новые изделия MONROE®.

Все претензии сначала рассматриваются дистрибьютором MONROE®, а затем утверждаются компанией MONROE®

При предъявлении рекламации розничный продавец или установщик должен предоставить дистрибьютору MONROE® следующую информацию:

- имя и адрес покупателя
- дата установки или продажи
- ассортиментный номер MONROE®
- данные техпаспорта транспортного средства
- документы, подтверждающие покупку
- описание дефекта

Гарантийные обязательства не распространяются на:

1. Естественный износ.
2. Изделия MONROE®, установленные вопреки рекомендациям, приведенным в каталоге MONROE® или последующих приложениях к нему.
3. Изделия MONROE®, которые были модифицированы или повреждены в результате неправильной установки или неправильного использования транспортного средства, вопреки спецификациям производителя или рекомендациям MONROE®.
4. Изделия MONROE®, поврежденные в результате установки на автомобиль, отличный от того, что указан в каталоге MONROE® или последующих дополнениях к нему.
5. Амортизаторы, поршневый шток или масляный затвор которых был поврежден в результате использования для захвата штока гаечного ключа или плоскогубцев вместо специально предназначенного для этого инструмента.
6. Преждевременный износ вследствие повторного использования крепежных деталей: например, резиновых защитных щитков, поврежденных отбойников, и т.п.
7. Повреждения в результате аварии.
8. Изделия MONROE®, поврежденные в результате участия автомобиля в ралли или спортивных гонках.
9. Изделия Ride-Levelers с истертым в результате неправильной установки пневморукавом.
10. Восстановленные или отремонтированные изделия MONROE®.
11. Дефекты, возникшие вследствие несвоевременного технического обслуживания или неправильно проведенного технического обслуживания транспортного средства.

Примечание: Все изделия MONROE® разрабатываются и изготавливаются в соответствии с оригинальными спецификациями производителей автомобилей. В каталоге обозначены модели с опущенной подвеской, для которых подходят изделия MONROE®.

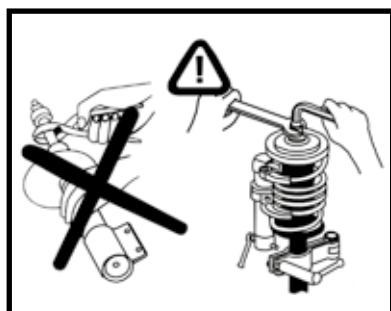



Image Courtesy of Audi 2016®

MONROE
OESpectrum®

REVOLUTIONARY SHOCK ABSORBER

MR-TECH²

OESpectrum
5-YEAR
WARRANTY

TAKE CONTROL

Limited warranty. Terms and Conditions apply. Available on www.monroe-oespectrum.com

Start stocking Monroe® shocks and struts today.
Contact your representative for details.
www.monroe-oespectrum.com

MONROE

USEFUL LINKS

FITTING INSTRUCTION

TA.TENNECO-EMEA.INFO/SCORM/FITTING/

NEW ITEMS

MONROE.COM/EN-UK/SUPPORT/CATALOGUE/NEWS-ITEMS/

MONROE 360°

MONROE.SPSBE.COM/DOCUMENTS/360MONROE

TECHLINE

WWW.MONROE-WALKER-TECHLINE.COM



CATALOGUE

TA.TENNECO-EMEA.INFO/SCORM/TADIS/#/GRID-MENUS/1-1-1.HTML



WWW.MONROE.COM



[HTTP://TA.TENNECO-EMEA.INFO/TECHNICAL.PHP](http://TA.TENNECO-EMEA.INFO/TECHNICAL.PHP)



[HTTP://TV.TENNECO-EMEA.INFO/](http://TV.TENNECO-EMEA.INFO/)



[HTTP://MONROE.COM/EN-UK/SUPPORT/CUSTOMER-SERVICE/](http://MONROE.COM/EN-UK/SUPPORT/CUSTOMER-SERVICE/)

NO ONE BUT

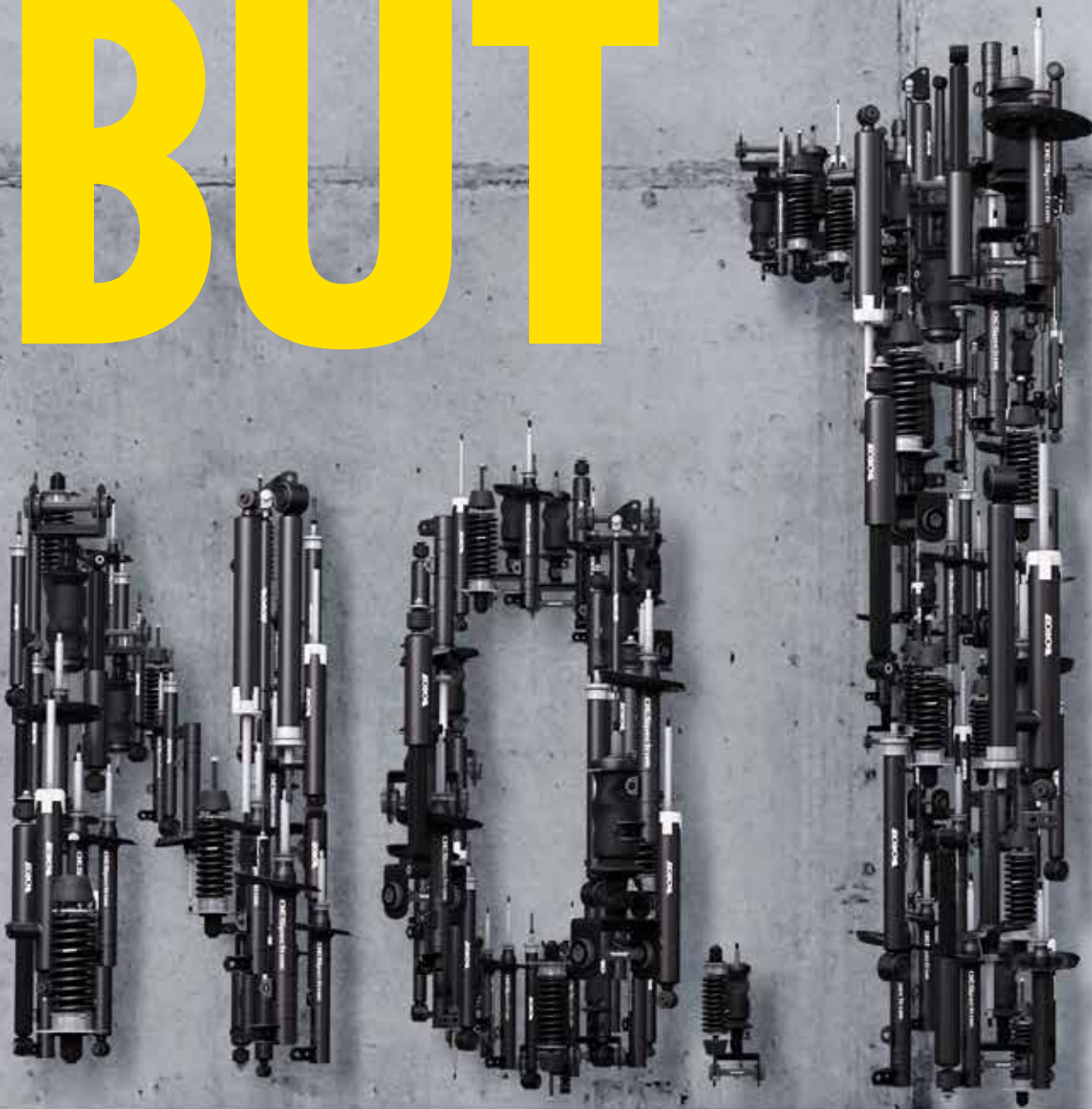

CAN SAY

**WE HAVE THE LARGEST COVERAGE
OF LIGHT VEHICLE SHOCKS IN EUROPE***

Start stocking Monroe® shocks and struts today.
Contact your representative for details. www.monroe.com

* Source TecAlliance 2016 - 92% coverage for light vehicles in Europe, Middle East & Africa.

MONROE

Tenneco Customer services

Customer Service

All regions except: France, Spain, UK
T +32 11 703 164 North and West Europe
T +32 11 703 335 South and East Europe
F +32 11 703 310

Customer Service France

T +33 (0)970 80 96 85
F +33 (0)2 43 66 64 58
F +33 (0)2 43 66 64 59

Customer Service Southern Africa

Orders: +27 (0)41 401 7352
Technical: +27 (0)11 574 5603

Customer Service Spain/Portugal

T +34 902 197 300
F +34 916 710 800

Customer Service UK/Ireland

T +44 (0)121 609 3000
F +44 (0)121 609 3037
salesUK@tenneco.com

Tenneco Aftermarket offices

Tenneco Europe - Tenneco Benelux

Avenue du Bourgetlaan 50
1130 Brussels, Belgium

Tenneco CEE South

Prekratova 39
10020 Zagreb, Croatia

Tenneco Czech Republic

Rychnovska 383
463 42 Hodkovice nad Mohelkou
Czech Republic

Tenneco Denmark

Sjællandsvvej 2
5500 Middelfart, Denmark

Tenneco France

ZA des Giraumeries
BP4149 Route d'Ahuillé
53941 Saint-Berthevin cedex

Tenneco Germany

Luitpoldstrasse 83
67480 Edenkoben, Deutschland

Tenneco Iberica

Avda. de la Cañada, 64-66
posterior - P.I. Coslada
28820 Coslada, Madrid, Spain

Tenneco Italy

Via W. Tobagi, 13
20068 Peschiera Borromeo
(Milano) Italia

Tenneco Middle East, Africa

Tenneco Automotive Europe bvba

Avenue du Bourgetlaan 50
1130 Brussels, Belgium

Tenneco Poland & CEE

ul. Bojkowska 59B
44-100 Gliwice, Poland

Tenneco Portugal

Parque Industrial da Autoeuropa
2950-403 Pamela, Portugal

Tenneco Russia and CIS

Glazovsky pereulok 7
Moscow, 119002, Russian Federation

Tenneco Southern Africa

Block B, 2nd Floor, Pellmeadow Office Park,
60 Civin Drive, Essexwold, Bedfordview
2007 Johannesburg, South Africa

Tenneco Sweden & Baltics

Rosendalsvägen 5
340 15 Vittaryd, Sweden

Tenneco Turkey

Çavuşoğlu Mah. Spor Cad.
No: 86 34873 Kartal - İstanbul, Türkiye

Tenneco UK

Wharfdale Road
Birmingham B11 2DF, England
T +44 (0)121 609 3000
F +44 (0)121 609 3037

Tenneco Ukraine (Russia and CIS)

Kudryashova 3, office 130(15)
03035, Kyiv, Ukraine

Tenneco Original Equipment - Ride Control Plants Worldwide

ASIA

Beijing, China
Suzhou, China
Bawal, India
Hosur, India
Pondicherry, India
Chonburi, Thailand

AUSTRALIA

Adelaide, Australia
Sydney, Australia

EUROPE - SOUTH AFRICA

Sint-Truiden, Belgium
Hodkovice, Czech Republic
Hannover, Germany
Bologna, Italy
Gliwice, Poland
Ermua, Spain
Port Elizabeth, South Africa

NORTH AMERICA

Paragould, Arkansas
Long Beach, California
Hartwell, Georgia
Angola, Indiana
Kettering, Ohio
Napoleon, Ohio
Owen Sound, Ontario
Celaya, Mexico
Reynosa, Mexico

SOUTH AMERICA

Rosário, Argentina
Cotia, Brazil
Magi Mirim, Brazil



Tenneco only uses paper that is recyclable and from responsibly managed sustainable forestry sources.

