

MONROE



**CATALOGUE FOR
SHOCK AND STRUTS
INCLUDING MOUNTING
AND PROTECTION KITS**















2024-2025











South Africa

www.monroe.com/en-za/

Catalogue key: body types

 All vehicle types	 Horse	 Sedan
 Bus	 Minibus	 Stationwagon
 Cabriolet	 MPV	 SUV/4x4
 Coupe	 Panelvan	 Trailer
 Hatchback	 Pickup	 Truck

Catalogue key: mounting guide

 Telescopic stud; Upper mounting	 Telescopic eye; Metal sleeve	 Telescopic eye; Special mounting
 Telescopic stud; Lower mounting	 Telescopic eye; Cross stem	 Strut insert/cartridge
 Telescopic eye; Rubber	 Telescopic eye; Bolt	 Sealed strut

Contents

Alphabetical listing: passenger and light commercial vehicles.....	2
Alphabetical listing: heavy commercial vehicles.....	114
Numerical listing: seat dampers.....	158
Alphabetical listing: Maxlift.....	160
Universal applications: Maxlift.....	188
Numerical listing: passenger.....	192
Numerical listing: commercial and cab dampers.....	275
Numerical listing: Maxlift.....	296
Numerical listing: protection kits, mounting kits, springs.....	314
Identification of shock absorber mountings.....	374
Shock grouping by closed length.....	376
The Monroe® Range.....	398
Product warranty.....	Inside back cover

Supplementary information













!	Excluding self levelling suspension
~	Imported
“ .. ” “ ... ”	Special order – phone 010 900 1850 6-12 week waiting period
bold	Heavy duty
<u>underlined</u>	Not immediately available
> <i>italic</i>	While stocks last
	Steering damper
PK...	Protection kit part number
MK...	Mounting kit part number
AK...	Replacement bolt or spring part number
#	Internal bump-stop

Important installation information

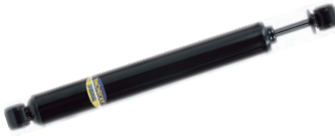
*1	Re-use original locking screw from vehicle
*2	Balancing weights may need to be transferred from the old shocks to the new
*3	Certain '84-'92 models may need spacers placed below the cartridge in the strut tube
*4	Contact our help desk on 011 574 5603 if you require assistance with rod top end diameter and length
*5	When replacing Original Equipment with replacement market shocks the indicated Monroe springs must be fitted as well or the vehicle will sag
*6	If the vehicle uses Nivomat levelling shocks (no pipes) as original equipment then it is agents only
*7	Re-use existing original equipment top rubbers
*8	Re-use existing spring seat/pan
*9	Use correct torque
*10	Mounting angle critical, use tool K81
*11	If the OE shocks have weights in the upper mounting area, these are to be removed for the replacement part to fit in upper mounting
*12	SA1942 does not fit directly in place of the original equipment, but attaches to the drag link
*13	Check the original equipment part number on the old shock for the correct application
*14	Excluding bump stop and gaiter – use protection kit
*15	Shocks shorter due to internal rebound spring
*16	Remove second from the top spigot (curved) washer under the top rubber, just above the vehicle body

MONROE RANGE GUIDE

CHOOSE QUALITY THAT ENDURES FOR YOUR SHOCK & STRUT REPLACEMENTS

PASSENGER VEHICLES	 <p>Monroe shocks & struts</p> <ul style="list-style-type: none"> • High-quality premium shocks & struts for light vehicles • Built for safety: stop sooner, drive safer with new shocks • Designed for durability: key features make Monroe shocks last longer • Advanced technologies adapted to the type of vehicle: combustion and electric cars and bakkies • Five year warranty against manufacture or material defect.* 		
	 <p>Monroe Magnum – axle dampers</p> <ul style="list-style-type: none"> • Tough and reliable ultra-heavy-duty technology for medium and heavy commercial vehicles (trucks, buses, trailers) • Two year warranty against manufacture or material defect. 		
COMMERCIAL VEHICLES	 <p>Monroe Magnum – cabin dampers</p> <ul style="list-style-type: none"> • Heavy duty dampers to assist in maintaining the comfort and safety of the driver over bumpy roads • Helps support the weight of the truck cabin, and controls the swaying motion • Seat dampers also available • Two year warranty against manufacture or material defect. 		
	<p>Maxlift</p> <ul style="list-style-type: none"> • Gas charged lift supports • Functions like a gas spring to hold open doors, boots, bonnets, windows, hatches, etc. • Two year warranty against manufacture or material defect. 	<p>Protection Kits & Mounting Kits</p> <ul style="list-style-type: none"> • Extends the life of the shock, less claims, better handling, reduced noise • Five year warranty against manufacture or material defect.* 	<p>Steering Dampers</p> <ul style="list-style-type: none"> • Well priced, quality steering control in off-road and normal driving conditions. 
LIGHT COMMERCIAL VEHICLES	 <p>Monroe Gas-Magnum</p> <ul style="list-style-type: none"> • Value for money, advanced heavy-duty gas technology for bakkies, 4x4s and SUVs • Part numbers start with M... • Five year warranty against manufacture or material defect.* 		
	 <p>Monroe Adventure</p> <ul style="list-style-type: none"> • For drivers who want more. High pressure, mainly mono-tube, heavy-duty gas technology for SUVs, 4x4s and bakkies • Part numbers start with D... • Five year warranty against manufacture or material defect.* 		
	 <p>Rancho</p> <ul style="list-style-type: none"> • <i>Designed for hard-working vehicles</i> • RS9000 series is adjustable to <i>nine levels of performance</i>, with a nine-position easy-to-adjust knob for customised damping control and firmness for both on- and off-road flexibility • RS5000X series uses a unique, patented valving system and advanced compression functionality • Robust Tri-Tube (RS9000) and Twin-Tube (RS5000) designs • Three year warranty against manufacture or material defect. 		

*Terms & conditions apply – Visit the Monroe website for details



Passenger and light commercial

Part number [alphabetical listing]

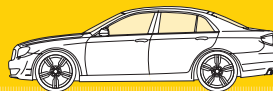

Year	Application	Front					Rear				
		Entry shocks	Premium shocks	Springs	Protection kits/ Mounting kits	Mounting information	Entry shocks	Premium shocks	Springs	Protection kits/ Mounting kits	Mounting information
ALFA ROMEO											
145 / 146											
94-97	145 & 146 1.3, 1.6, 1.7 16v	—	—	—	"PK024" / "MK007"		G1264	—	—	"PK130" (Bump rubber only)	
94-June 01	145 & 146 1.4TS, 1.6TS, 1.8TS, 1.9TDS & 2.0 TS	"G16598"	—	—	"PK024" / "MK007"		G1264	—	—	"PK130" (Bump rubber only)	
147											
June 01-10	147 1.6TS, 1.9JTD & 2.0TS hatch	45009	—	—	"PK092" / "MK349"		G8019	—	—	PK023 / MK200	
155											
91-97	155 (EXC) 2500 V6, 2.5TD, 2.0 Turbo AWD, elec susp)	"G16598"	—	—	"PK024" / "MK007"		G11031 > G1264	—	—	"PK130" (Bump rubber only)	
91-97	155 2500 V6, 2.5TD (EXC) elec susp)	"16599"	—	—	"PK024" / "MK007"		G11031 > G1264	—	—	"PK130" (Bump rubber only)	
156											
97-05	156 ALL (EXC) GTA, Sport susp)	45009	—	—	"PK092" / "MK349"		"16406"	742216SP >	—	PK023 / MK200	
97-05	156 GTA & Sport Susp (EXC) 3.2 GTA)	45009 (EXC) GTA)	—	—	"PK092" / "MK349"		"G8350"	—	—	PK023 / MK200	
00-06	156 Sportwagon (EXC) GTA / elec susp / self leveling rears)	45009	—	—	"PK092" / "MK349"		"16406" !	E4940 > / 742047SP > !	—	PK023	
159											
05-11	159	"G2243"	—	—	"PK275" / "MK362"		"G1343"	—	—	—	
164											
90-98	164 (EXC) elec. susp. / leveling systems)	—	—	—	—	Check OE #'s	"16538" !	—	—	"PK007" /	
166											
99-07	166 3.0 V6 & 3.2 V6 (EXC) 2.0, 2.4, 2.5)	"G1260"	—	—	"PK092" / "MK349"		"G1261"	—	—	—	
Brera											
06-10	Brera 2.2 JTS & 3.2 V6	"G2243"	—	—	—		"G1646"	—	—	—	
Giulia											
66-77	Giulia 1300, 1600, 1750, 2000 & Super T.I. Bertina & Coupe	"R1549"	—	—	—		"R2554"	—	—	—	
15-on	Giulia (952) 2.0T, 2.9 V6 Quadrifoglio	—	—	—	—	—	—	—	—	—	—
Giulietta											
10-20	Giulietta (940) All	G8312 R G8313 I	—	—	"PK355" / "MK473R" & "MK474L"		G2524	—	—	"PK460"	
GT											
05-10	2.0 & 1.9JTD & 3.2 V6 GTA	45009	—	—	"PK092" / "MK349"		"G8617" (EXC) GTA) / or GTA 3.2 V6 = "G8350" >	—	—	PK023 / MK200	
MiTo											
09-18	MiTo hatch 1.4, 1.4T, 1.6JTD (EXC) 1.4T QV sport, 1.8T GTA & Elec susp)	G8112 R G8113 I	—	—	"SP4017" R "SP4018" !!	PK140 / MK305		G1091 !	—	"SP4019"	PK018 / MK384R & MK385L
Spider / Junior											
68-81	Spider 1.3, 1.6, 1750 & 2.0 Junior & Veloce	"R1549"	—	—	—		"R2554"	—	—	—	

Key

*	See important installation information on inside front cover
!	Excluding self-leveling suspension
"..."	Special order - phone 010 900 1850. 6-12 week waiting period

~	Imported
#	Internal bump stop
	Steering damper

- It is recommended that all new shock absorbers are fitted in pairs
- Do not mix gas and non-gas units on the same axle
- **Bold** part numbers indicate heavy-duty shocks
- Underlined part numbers indicate parts not immediately available
- *Italic* part numbers followed by > indicate parts to be discontinued

Passenger and light commercial

Part number [alphabetical listing]

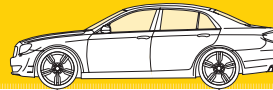

Year	Application	Front					Rear				
		Entry shocks	Premium shocks	Springs	Protection kits/ Mounting kits	Mounting information	Entry shocks	Premium shocks	Springs	Protection kits/ Mounting kits	Mounting information
ALFA ROMEO <i>continued</i>											
Stelvio											
17-on	Alfa Stelvio SUV										
Tonale											
23-on	Tonale 1.5T Hybrid		-	-	-			-	-	-	

AUDI											
80											
75-Mid 81	80 Sedan & S/Wagon	GT0102	-	-	"PK047" / "MK032" (78-81 only)		"R3738"	-	-	PK015	⊥ ⊕
100 / 200											
70-77	100	-	-	-	-		-	-	-	-	⊥ ⊕
77-83	100, 200	MR315	-	-	Recommended the PK & MK's are replaced with Audi OE units		-	-	-	"PK014"	⊥ ⊕
400 / 500											
83-94	400, 500 Quattro, sport susp & S4)	MR315		-	"PK038" / "MK044"		"R6335"	-	-	<i>PK094</i> > PK078 / "MK119"	⊥ ⊕
91-94	500 Quattro sedan and Avant S/W std susp S4 & sport susp)	MR315		-	"PK038" /		"26339" !	-	-	-	⊥ ⊕
91-94	500 Quattro sport suspension sedan and Avant S/W S4)	MR315	-	-	/ "MK043"		"26340" !	-	-	-	⊥ ⊕
91-94	S4 2.2 4.2 & sports susp)	MR315	-	-	-		"26340" !	-	-	-	⊥ ⊕
Audi 80 / 100 / 500											
92-01	80 / 100 / 500 Cabriolet	"MR967"	-	-	"MK032"		"G55015"	-	-	-	⊥ ⊕
A1											
11-May 18	A1 Gen 1 (8X) Sport susp (122 PS)	GT8123	-	SP3983 (Manual)	PK076 / MK077		G1339	-	SP3984	PK078 / MK118	⊥ ⊕
11-May '18	A1 Gen 1 (8X) Sport susp & 1.4 TFSi (185 PS)		742044SP		PK076 / MK077		G1339	-		PK078 / MK118	⊥ ⊕
June 18-on	A1 Sportback Gen 2 (6B) 30TFSi (1.0), 35TFSi (1.5), 40TFSi (2.0) Sport susp)	GT8625	-		PK422 / MK411		GT1376	-		MK436	⊥ ⊕
A3											
98-April'03	A3 1.8 & 1.8T turbo, 1.9TDi Sport Susp, Quattro & S3)	GT8020	-	SP0335 > SE0335	PK076 / MK077 OE# = 8L0 823 359 B		GT1002	-	SP0653	PK078 / MK118	⊥ ⊕
98-April'03	A3 Sport Susp Quattro)	GT8020	-		PK076 / MK077 OE# = 8L0 823 359 B		"G1368"	-		PK078 / MK118	⊥ ⊕
99-April'03	A3 Quattro Sport Susp)	"G8378"	-				G1236	<i>376055SP</i> >			⊕ ⊕
00-April'03	S3 Quattro sport)	"G8618"	-				G1236	<i>376055SP</i> >	-		⊕ ⊕
May'03-12	A3 all Sportback Quattro, Sport Susp & S3) OE Strut leg bottom outer diam = 50mm	GT8058	<i>742243SP</i> >	SP3423 (2.0 Fsi) SP3422 > SE3422 (2.0 Tdi) SP3424 (HD) (2.0 Tdi 103kw-125kw)	PK163 / MK194		GT2210	<i>376027SP</i> >	SP3425 (2.0 Fsi) SP3427 (2.0 Tdi) SP3428 (2.0 Tdi 103kw-125kw)	Oval = PK135 / MK386 OR Round = PK277 / MK203	⊥ ⊕ Select either round or oval PK / MK's
	OE Strut leg bottom outer diam = 55mm	<i>GT8056</i> > GT8057	<i>742247SP</i> >	SP3423 (2.0 Fsi) SP3422 > SE3422 (2.0 Tdi) SP3424 (HD) (2.0 Tdi 103kw-125kw)	PK163 / MK194		GT2210	<i>376027SP</i> >	SP3425 (2.0 Fsi) SP3427 (2.0 Tdi) SP3428 (2.0 Tdi 103kw-125kw)	Oval = PK135 / MK386 OR Round = PK277 / MK203	⊥ ⊕ Select either round or oval PK / MK's

Key

*	See important installation information on inside front cover
!	Excluding self-leveling suspension
"..."	Special order - phone 010 900 1850. 6-12 week waiting period

~	Imported
#	Internal bump stop
⊕	Steering damper

- It is recommended that all new shock absorbers are fitted in pairs
- Do not mix gas and non-gas units on the same axle
- **Bold** part numbers indicate heavy-duty shocks
- Underlined part numbers indicate parts not immediately available
- *Italic* part numbers followed by > indicate parts to be discontinued

Passenger and light commercial

Part number [alphabetical listing]



Year	Application	Front					Rear				
		Entry shocks	Premium shocks	Springs	Protection kits/ Mounting kits	Mounting information	Entry shocks	Premium shocks	Springs	Protection kits/ Mounting kits	Mounting information
AUDI continued											
A3 continued											
May'03-12	A3 & S3 Quattro and sport suspension 2.0 & 3.2 : 55mm OD strut only (EXC) S3 front & all RS3)	"G8388"	—	—	PK163 / MK194	55mm OD strut only (EXC) OE # 1T0413031HS)	GT2210	376027SP >	—	Oval = PK135 / MK386 OR Round = PK277 / MK203	Select either round or oval PK / MK's
Late '12-20	(EXC) Sportback, Quattro, Sport Susp (EXC) S3 & Elec susp) . OE Strut leg outer diam = 50mm	—	742116SP	—	PK422 / MK411	Check OE #	—	376193SP OR 376194SP OR 376195SP !	PK442 / MK503	376193SP = 11mm rod & 45mm btm sleeve / 376194SP = 13mm rod & 45mm btm sleeve / 376195SP = 13mm rod & 59mm btm sleeve	
	OE Strut leg outer diam = 55mm	—	742117SP	—	PK422 / MK411	Check OE #	—	376193SP OR 376194SP OR 376195SP !	PK442 / MK503	E1387 = 11mm rod & 45mm btm sleeve / 376194SP = 13mm rod & 45mm btm sleeve / 376195SP = 13mm rod & 59mm btm sleeve	
21-on	(EXC) Sportback, Quattro, Sport Susp, S3 (EXC) elec susp) . OE Strut leg outer diam = 50mm	—	742116SP OR 742117SP	—	PK422 / MK411	Check OE # 742116SP = 50mm strut leg OD & 742117SP = 55mm strut leg OD	—	376195SP !	PK442 / MK503	376195SP = 13mm rod & 59mm btm sleeve	
	OE Strut leg outer diam = 55mm	—	—	—	—	—	—	—	—	—	
A3											
12-on	A3 Cabriolet (EXC) Quattro Gen 3 (8V)	—	742116SP OR 742117SP	—	PK422 / MK411	Check OE # 742116SP = 50mm strut leg OD & 742117SP = 55mm strut leg OD	—	376195SP !	PK442 / MK503	376195SP = 13mm rod & 59mm btm sleeve	
A4											
95-Jan'99	(EXC) Quattro, Sport) 8D, B5	GT2201	—	SP0068	PK088 / MK190	Confirm year / S/pan unit / Btm U brkt	GT1001 *10	—	SP0675	PK016 / MK188	S/pan unit Confirm year OE# 8D0513031A or 8D5513031H
95-Jan'99	(EXC) Sport,) 8D, B5	GT2201	—	—	PK088 / MK190	Confirm year / S/pan unit / Btm U brkt	"G2251"	—	—	—	Confirm year
96-Jan'99	(EXC) Quattro, Sport) 8D, B5	GT2201	—	SP0068	PK088 / MK190	Confirm year / S/pan unit / Btm U brkt	"23842" *10	376057SP > *10	"SP0667"	PK016 / MK188	Confirm year S/pan unit
Feb'99- Nov'00	(EXC) : Sport susp, Avant S/W & Quattro) B5, 8D	GT2201	376028SP >	SP0068	PK088 / MK190	S/pan unit / Confirm year / Check OE#'s / Btm U brkt	23905	376232SP > *10	SP0675	PK016 / MK188	Confirm year S/pan unit
Feb'99- Nov'00	(EXC) S4) B5, 8D	26654	376028SP >	—	PK088 / MK190	Confirm year	"G2252" (Sport Quattro)	"G2251" (Quattro) & "376238SP" > (Sport Quattro)	—	—	Confirm year

Key

*	See important installation information on inside front cover
!	Excluding self-leveling suspension
"..."	Special order - phone 010 900 1850. 6-12 week waiting period

~	Imported
#	Internal bump stop
⊕	Steering damper

- It is recommended that all new shock absorbers are fitted in pairs
- Do not mix gas and non-gas units on the same axle
- **Bold** part numbers indicate heavy-duty shocks
- Underlined part numbers indicate parts not immediately available
- *Italic* part numbers followed by > indicate parts to be discontinued

Passenger and light commercial

Part number [alphabetical listing]

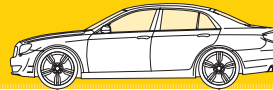

Year	Application	Front					Rear				
		Entry shocks	Premium shocks	Springs	Protection kits/ Mounting kits	Mounting information	Entry shocks	Premium shocks	Springs	Protection kits/ Mounting kits	Mounting information
AUDI continued											
A4 continued											
Feb'99- Nov'00	A4 Avant [Exc] : Sport susp, sedan & Quattro) B5, 8D	GT2201	376028SP >	SP0068	PK088 / MK190	⊥ ⊗ S/pan unit / Confirm year / Check OE#s / Btm U brkt	"23906" *10	—	"SP0667"	MK188	⊥ ⊕ S/pan unit / Confirm year
Feb'99- Nov'00	A4 Avant Quattro [Exc] S4 & Sport suspension)	26654	376028SP >	—	Confirm year PK088 / MK190	⊥ ⊗	"G2252"	"376238SP" >	—	Confirm year	⊕ ⊕ S/pan unit
Dec'00-04	A4 Sedan & Avant + Quattro [Exc] Sport Susp, S4, & RS4) B6, 8E	GT2202	376006SP > (firmer ride)	SP3364 [Exc] Quattro)	PK175 / MK207	⊥ ⊗ S/pan unit OE # 8E0413031AR / 8E0413031BJ s/pan unit	GT1006 *10	—	SP3381 [Exc] Quattro)	PK137 [Exc] Quattro (Quattro = "PK101") / MK297	⊥ ⊕ No s/pan OE # 8E0513033J / 8D0513031D
Dec'00-04	A4 Sedan and Avant Sport Suspension [Exc] Quattro sport [Exc] S4 & RS4) B6, 8E	"G2248"	—	—	PK175 / MK207	⊥ ⊗ OE # 8E0413031BN / ...BG / ...BH / ...BN / ...BP / ...BS / ...CL / ...CK	"G1362"	—	—	PK137 [Exc] Quattro (Quattro = "PK101") / MK297	⊥ ⊕ OE # 8E0513033 G ...H / ...N
05-07	A4 [Exc] Quattro, Avant & Allroad [Exc] Sport susp, S4 & RS4) B7	GT2202	376006SP >	—	PK175 / MK207	⊥ ⊗ S/pan unit	GT1006	—	—	PK137 [Exc] Quattro (Quattro = "PK101") / MK297	⊥ ⊕
05-07	A4 Sport susp [Exc] Quattro, Avant & Allroad [Exc] S4 & RS4) B7	"G2248"	—	—	PK175 / MK207	⊥ ⊗ S/pan unit	"G1055A"	—	—	PK137 [Exc] Quattro (Quattro = "PK101") / MK297	⊥ ⊕
02-08	A4 Cabriolet [Exc] Sport susp	"G2248"	—	—	PK175	⊥ ⊗	"23956"	E1283 >	—	"PK101" / MK297	⊥ ⊕
08-Jan 16	A4 Sedan & Avant [Exc] Sport susp, Quattro, Elec susp & S4) B8	—	376042SP !	"SP3923" (1.8 TFSi & 2.0 TFSi) OR "SP3924" (2.0 Tdi)	PK281 / MK361	⊥ ⊗ re-use OE s/seat	G2514	—	"SP3925" OR "SP3926"	PK279 / MK388	⊥ ⊕
08-Jan 16	A4 Sedan & Avant Sport Susp, [Exc] Quattro [Exc] S4 & Elec susp) B8	—	376042SP !	—	PK281 / MK361	⊥ ⊗	—	"376214SP" !	—	PK279 / MK388	⊥ ⊕
Feb 16-on	A4 Sedan [Exc] Quattro (8W) [Exc] Sport susp & S4) B9 (53mm btm mtng housing diam)	—	376255SP	—	PK471 / MK489	⊥ ⊗ (Check btm mtng housing diam)	—	376248SP [Exc] sport susp)	—	/ MK493	⊥ ⊕
Feb 16-on	A4 Sedan [Exc] Quattro (8W) Sport susp [Exc] S4) B9 (48mm btm mtng housing diam)	—	"376254SP"	—	PK471 / MK489	⊥ ⊗ (Check btm mtng housing diam)	—	376248SP [Exc] sport susp)	—	/ MK493	⊥ ⊕
A5											
08-Jan '16	A5 Sportback Coupe, Cabrio & Quattro [Exc] Sport Susp, S5 & RS5) (8T, B8)	—	376042SP	—	PK281 / MK361	⊥ ⊗	G2514 !	—	—	PK279 / MK388	⊥ ⊕
Feb '16-on	A5 Sportback Coupe, Cabrio & Quattro [Exc] RS5) (F5, B9)	—	376255SP (53mm housing) / OR "376254SP" (48mm housing)	—	PK471 / MK489	⊥ ⊗ (Check btm mtng housing diam)	—	376248SP [Exc] sport susp)	—	/ MK493	⊥ ⊕
S5 & RS5											
08-Jan 16	S5 Sportback Coupe & Cabrio [Exc] A5 Sport Susp, Quattro [Exc] RS5 4.2 V8 (8T)	—	"376178SP" > 376042SP !	—	PK281 / MK361	⊥ ⊗	—	"376214SP"	—	PK279 / MK388	⊥ ⊕
Feb 16-on	S5 Sportback Coupe & Cabrio [Exc] A5 Sport Susp, Quattro [Exc] RS5 4.2 V8 (B9)	—	376255SP (53mm housing) / OR "376254SP" (48mm housing)	—	PK471 / MK489	⊥ ⊗ (Check btm mtng housing diam)	—	376248SP [Exc] sport susp)	—	/ MK493	⊥ ⊕

Key	
*	See important installation information on inside front cover
!	Excluding self-levelling suspension
"..."	Special order - phone 010 900 1850, 6-12 week waiting period

~	Imported
#	Internal bump stop
⊕	Steering damper

- It is recommended that all new shock absorbers are fitted in pairs
- Do not mix gas and non-gas units on the same axle
- **Bold** part numbers indicate heavy-duty shocks
- Underlined part numbers indicate parts not immediately available
- *Italic* part numbers followed by > indicate parts to be discontinued

Passenger and light commercial

Part number [alphabetical listing]

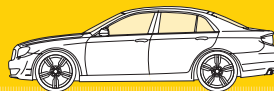

Year	Application	Front					Rear				
		Entry shocks	Premium shocks	Springs	Protection kits/ Mounting kits	Mounting information	Entry shocks	Premium shocks	Springs	Protection kits/ Mounting kits	Mounting information
AUDI continued											
A6											
94-July 97	A6 Sedan & Avant (EXC) Quattro, Sport susp., & S6)	MR315	—	—	"PK038" / "MK043"		"R6335" !*10	—	—	PK094 > PK078 / "MK119"	⊥ ⊕
94-July 97	A6 Sedan & Avant Quattro (EXC) Sport suspension & S6)	MR315	—	—	"MK043"		"26339" !*10	—	—	/ "MK119"	⊥ ⊕
94-July 97	A6 & S6 4.2 Sedan & Avant Quattro Sport suspension (EXC) S6)	MR315	—	—	"MK043"		"26340" !*10	—	—		⊥ ⊕
97-Jan'99	A6 Sedan & Avant (EXC) 2.7 Turbo, Quattro, Allroad & 4.2 V8) Only up to -> chassis No's 4B#X#070 000	26654	376028SP >	—	PK088 / MK190	⊥ ⊗ Check Chassis #	45008 !*10	376081SP > !*10	—	"PK101" / "MK187"	⊥ ⊕ No s/pan Check Chassis #
97-April'00	A6 2.7 Turbo (EXC) Quattro, Allroad & 8 cyl) Up to -> chassis No's 4B#Y#200 000	—	376104SP >	—	PK088 / MK190	⊥ ⊗ Check Chassis #	45008 !*10	376081SP > !*10	—	"PK101" / "MK187"	⊥ ⊕ No s/pan Check Chassis #
97-Jan'99	A6 Quattro sedan & Avant S/W (EXC) 2.7 turbo, Allroad & 4.2 V8) Only up to -> chassis No's 4B#X#070 000	26654	376028SP >	—	PK088 / MK190	⊥ ⊗ Check Chassis #	62246 !*10	376058SP > !*10	—		⊥ ⊕ No s/pan Check Chassis #
Feb'99-April'00	A6 Sedan & Avant S/W (EXC) Quattro, Allroad & 8cyl) (EXC) 2.7 Turbo From chassis No's 4B#X#070 000 -> 4B#Y#200 000	—	376104SP >	—	PK088 / MK190	⊥ ⊗ Check Chassis #	45008 !*10	376081SP > !*10	—	"PK101" / "MK187"	⊥ ⊕ No s/pan Check Chassis #
Feb'99-April'00	A6 Quattro sedan & Avant (EXC) 2.7 turbo, Allroad & 4.2 V8) From chassis No's 4B#X#070 000 -> 4B#Y#200 000	—	376104SP >	—	PK088 / MK190	⊥ ⊗ Check Chassis #	62246 !*10	376058SP > !*10	—		⊥ ⊕ S/pan unit Check Chassis #
97-April'00	A6 2.7 Quattro Turbo, (EXC) Allroad 4WD & 4.2 V8) Up to -> chassis No's 4B#Y#200 000	—	376104SP >	—	PK088 / MK190	⊥ ⊗ Check Chassis #	62246 !*10	376058SP > !*10	—		⊥ ⊕ S/pan unit Check Chassis #
May'00-March'04	A6 Sedan & Avant (EXC) Quattro, Allroad, 8cyl & Air Susp) From Ch# : 4B#1#000 001 -on	26655	376030SP >	—	PK088 / MK190	⊥ ⊗ Check Chassis # OE# = 4B0412031CB / CA / BT	45008 !*10	376081SP > !*10	—	"PK101" / "MK187"	⊥ ⊕ No s/pan Check Chassis #
May'00-May'01	A6 Quattro sedan & Avant (EXC) Allroad & 4.2 V8)	26655	376030SP >	—	PK088 / MK190	⊥ ⊗ Check Chassis # OE# = 4B0412031CB / CA / BT	62246 ! (EXC) air susp)	—	—	—	⊥ ⊕ Check Chassis #
June'01-'04	A6 Quattro Sedan & Avant (EXC) All Road & 4.2 V8)	26663	376054SP >	—	PK088 / MK190	⊥ ⊗ Check Chassis #	62246 ! (EXC) air susp)	—	—	—	⊥ ⊕ Check Chassis #
July'04-11	A6 Sedan & Avant (EXC) Quattro (EXC) Air susp) C6 Typ 4F	—	376024SP	—	PK363 / MK299	⊥ ⊗	—	376213SP ! (EXC) air susp)	—	MK297	⊥ ⊕
11-19	A6 Sedan & Avant (EXC) Quattro (EXC) Air & Elec susp) C7 Typ 4G	—	E8504 > / 376243SP	—	PK391 / MK207 (EXC) bearings)	⊥ ⊗	—	376025SP ! (EXC) air susp)	—	PK279 / MK443 (EXC) bearings) / MK425 (bearings only)	⊥ ⊕
20-on	A6 Sedan & Avant (EXC) Quattro (EXC) Air & Elec susp) C8 Typ 4A	—	—	—	—	—	—	—	—	—	—
A7											
11-early '18	A7 Sportback (EXC) Quattro (EXC) Air or elec susp, and S7 or RS7 4.0 V8) 468	—	376244SP	—	PK281 / MK207 (EXC) bearings)	⊥ ⊗	—	376025SP !	—	MK443 (EXC) bearings)	⊥ ⊕
early '18-on	A7 Sportback (EXC) Quattro (EXC) Air or elec susp, and S7 or RS7 4.0 V8) 469	—	—	—	—	—	—	—	—	—	—
e-Tron											
23-on	e-Tron electric	—	—	—	—	—	—	—	—	—	—
Q2											
17-23	Q2 (35) 1.0, 1.4 (GAB & GAG)	—	742117SP	—	PK422 / MK411 (EXC) bearings)		—	376277SP	—	MK517 (EXC) bearings)	⊥ ⊕

Key

*	See important installation information on inside front cover
!	Excluding self-leveling suspension
"..."	Special order - phone 010 900 1850. 6-12 week waiting period

~	Imported
#	Internal bump stop
⊕	Steering damper

- It is recommended that all new shock absorbers are fitted in pairs
- Do not mix gas and non-gas units on the same axle
- **Bold** part numbers indicate heavy-duty shocks
- Underlined part numbers indicate parts not immediately available
- *Italic* part numbers followed by > indicate parts to be discontinued

Passenger and light commercial

Part number [alphabetical listing]

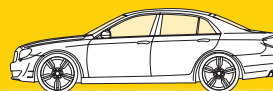

Year	Application	Front					Rear				
		Entry shocks	Premium shocks	Springs	Protection kits/ Mounting kits	Mounting information	Entry shocks	Premium shocks	Springs	Protection kits/ Mounting kits	Mounting information
AUDI <i>continued</i>											
Q3											
11-Sept '18	Q3 2.0TDI, 2.0T 4x2 & 4x4 Quattro (EXC) RS 2.5 sport or elec susp) 8U	GT8056 > GT8057	742000SP > 742247SP >	–	PK163 / MK194 (INC) bearings)		–	376000SP !	–	PK137 / MK203 (EXC) bearings)	\perp \ominus
Oct 18-on	Q3 1.4, 2.0 4x2 & 4x4 Quattro (EXC) RS 2.5 sport or elec susp) F3	–	742117SP	–	PK468 / MK411 (INC) bearings)		–	376246SP !	–	PK424 / MK517 (EXC) bearings)	\perp \ominus
Q5											
08-17	Q5 4x4 Quattro (EXC) sport susp) Typ 8R	–	376049SP	SP3944	PK278 / MK361 (EXC) bearings)	\perp \otimes	–	376048SP !	SP3945	PK279 / MK388 (EXC) bearings)	\perp \ominus
18-on	Q5 4x4 Quattro (EXC) sport susp, S or HD) FY	–	–	–	PK474 (std susp) OR PK471 (elec susp)		!	!	–	–	
Q7											
06-June '15	Q7 4x4 Quattro (EXC) sport or air susp) Gen one 4L (INC) facelift	–	D0301R / D0302L	–	PK280 / MK341	\perp \otimes	–	D8071 > D8071S !	–	PK276 / MK341	\perp \ominus
July '15-on	Q7 4x4 Quattro (EXC) sport or air susp) 4M	–	–	–	–		–	–	–	–	
Q8											
19-on	Q8 SUV	–	–	–	–		–	–	–	–	
TT											
00-06	TT 1.8 Turbo Coupe & Roadster/Cabriolet (8N) (EXC) Sport Susp & 3.2 V6 Quattro (8N)	"G8618"	–	–	PK076 / MK077		G1236 (Quattro) / G1368 (EXC) Quattro)	376055SP > (Quattro)	–	Quattro = MK118 / (EXC) Quattro = PK078 / MK118	G1236 = \ominus \ominus G1368 = \perp \ominus
07-March '15	TT 1.8T, 2.0T, 3.2 V6 Coupe & Roadster/Cabriolet, (INC) Quattro & Sport susp (8J) (EXC) elec susp & 2,5RS Quattro) (8J)	–	742253SP	–	PK345 / MK194		–	376228SP !	–	MK426 > MK426A	\perp \ominus
April '15-on	TT 1.8, 2.0, 2.0 Quattro, 2.5 Quattro Coupe & Roadster/Cabriolet, (INC) Quattro & Sport susp (8S) (EXC) elec susp & RS) (FV)	–	–	–	–		–	!	–	–	

AUSTIN

Mini (old)

59-84	Mini (INC) Cooper (MKIII)	GT1015	–	–	–	\ominus \ominus	GT1014	–	–	–	\perp \ominus
59-84	Mini	GT1015	–	–	–	\ominus \ominus	–	–	–	–	\perp \ominus

For new Mini ... see "Mini"

BAIC

B40

20-on	B40 plus 2.0 SUV	–	–	–	–		–	–	–	–	
-------	------------------	---	---	---	---	--	---	---	---	---	--

X55

22-on	X55 1.5T SUV	–	–	–	–		–	–	–	–	
-------	--------------	---	---	---	---	--	---	---	---	---	--

BAW (CAM) BEIJING AUTO WORKS

Indlovu

11-13	Indlovu minibus Taxi LWB 2.4l high roof		–	–	–			–	–	–	
-------	---	--	---	---	---	--	--	---	---	---	--

Inyati

07-13	Inyati minibus Taxi	GT2084 / M5464	–	–	–	\perp \ominus	GT2102 / M8074	–	–	–	\circ \circ
-------	---------------------	----------------	---	---	---	-------------------	----------------	---	---	---	-----------------

Leo

07-13	Leo LDV		–	–	–			–	–	–	
-------	---------	--	---	---	---	--	--	---	---	---	--

Key

*	See important installation information on inside front cover
!	Excluding self-leveling suspension
"..."	Special order – phone 010 900 1850, 6-12 week waiting period

~	Imported
#	Internal bump stop
\oplus	Steering damper

- It is recommended that all new shock absorbers are fitted in pairs
- Do not mix gas and non-gas units on the same axle
- **Bold** part numbers indicate heavy-duty shocks
- Underlined part numbers indicate parts not immediately available
- *Italic* part numbers followed by > indicate parts to be discontinued

Passenger and light commercial

Part number [alphabetical listing]

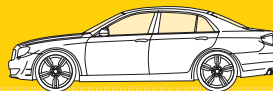

Year	Application	Front					Rear				
		Entry shocks	Premium shocks	Springs	Protection kits/ Mounting kits	Mounting information	Entry shocks	Premium shocks	Springs	Protection kits/ Mounting kits	Mounting information
BAW continued											
Sasuka											
13-on	BAW Sasuka 16 seater Taxi / 009 minibus		—	—	—			—	—		○ ○ (top 16mm ID & Btm 14mm ID, Closed 355mm, Open 560mm)
Rhino											
07-15	Rhino LDV	GT2023	—	—		⊥ ⊕	GT2024	—	—		

BMW											
1 Series											
E81 (3 door) E87 (5 door) E88 , E82											
End 04- Oct'11	1 Series 116i, 118i, 120i, 130i & 120d (EXCL Sport Susp, xDrive & 135i Coupe)	<i>G8212 R</i> > <i>G8213 L</i> > <i>G8292 R</i> <i>G8293 L</i>	<i>742040SP R</i> > <i>742041SP L</i> >	SP3431	PK012 / MK136		G2232	—	SP3434	PK167 / *MK379 OR *MK380 OR *MK444 (*Compare orig MK to photos prior to ordering, all EXCL bearings)	⊥ T
End 04- Oct'11	1 Series 116i, 118i, 120i, 130i, 135i & 120d Sport Susp EXCL std 135i Coupe (EXCL xDrive)	<i>G8292 R</i> <i>G8293 L</i>	<i>742069SP R</i> > <i>742070SP L</i> >	—	PK012 / MK136		G2232	—	—	PK167 / *MK379 OR *MK380 OR *MK444 (*Compare orig MK to photos prior to ordering, All EXCL bearings)	⊥ T
		MK379		MK380		MK444					

F20 5 door & F21 3 door											
Nov'11-19	1 series 116i, 118i, 120i, 125i & 120d (EXCL Sport Susp, Elec susp, x-Drive, 135i, M135i & M140i)		742132SP	—	PK372 / MK415			<i>376210SP ></i> <i>376211SP !</i>	—	PK379 / MK427 (bearing only) / MK446A (EXCL bearing)	⊥ ○
Nov'11-19	1 series Sport Susp (EXCL elec susp, x-Drive, M135i & M140i)		<i>742132SP</i> EXCL 135i) / <i>742133SP =</i> 135i only	—	PK372 / MK415			<i>376211SP !</i> EXCL 135i) / <i>376212SP =</i> 135i only	—	PK379 / MK427 (bearing only) / MK446A EXCL bearing)	⊥ ○
F40 1 Series											
Nov'19-on	1 series 118i, 120i & 120d (EXCL Sport Susp, Elec susp, x-Drive, M140i)			—					—		
2 Series											
F22 F23											
April'14-on	2 Series 220i, 228i, 230i, 220d (EXCL elec susp, 235i, M235i, M240i, M2 & Sport Susp)	—	742132SP	—	PK372 / MK415			<i>376211SP !</i>	—	PK379 / MK446A EXCL bearing)	⊥ ⊕

Key

*	See important installation information on inside front cover
!	Excluding self-levelling suspension
"..."	Special order – phone 010 900 1850. 6-12 week waiting period

~	Imported
#	Internal bump stop
⊕	Steering damper

- It is recommended that all new shock absorbers are fitted in pairs
- Do not mix gas and non-gas units on the same axle
- **Bold** part numbers indicate heavy-duty shocks
- Underlined part numbers indicate parts not immediately available
- *Italic* part numbers followed by > indicate parts to be discontinued

Passenger and light commercial

Part number [alphabetical listing]

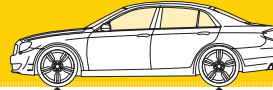

Year	Application	Front					Rear				
		Entry shocks	Premium shocks	Springs	Protection kits/ Mounting kits	Mounting information	Entry shocks	Premium shocks	Springs	Protection kits/ Mounting kits	Mounting information
BMW continued											
2 Series continued											
F22 F23 continued											
April'14-on	2 Series Sport Susp elec susp & M2	—	742132SP 235i, M235, M240 / 742133SP =235i, M235 & M240i only	—	PK358 / MK415		—	376212SP	—	PK379 / MK446A bearing	⊥ ⊕
F45											
April'14-17	2 Series Active Tourer MPV 218i, 220i, 225i, 220d M Tech & Sport Susp	G8640 G8641	—	—	PK421 / MK450 bearings		—	376260SP	—	PK475 / MK446A bearing	⊥ ⊕
3 Series											
E30											
84-91	318i, 320i, 323i & 325i (E30) iS & cabrio (51mm strut OD)	GT0702	—	SP0069 = 316, 318 SP0085 = 320, 323, 325	PK012 / MK036	(re-use BMW OE gandscrew locking nut)	GT2027	—	SP0480	MK120	⊥ ⊕
87-91	325iS Evo I & II std and E30 Cabriolet (51mm strut OD)	GT0702	—	—	PK012 / MK036	(re-use BMW OE gandscrew locking nut)	GT2027	—	—	MK120	⊥ ⊕
E36											
91-99	316i, 318i, 318is, 318tds, 320i, 323i, 325i, 325td, 325tds, 328i Imported & Local Strut. Cabrio. M. Tech). (E36)	—	742032SP 742033SP *4 *15	SP0100 = 316, 318 "SP0166" = 320, 323, 325	PK012 / MK045	(short neck)	GT2043	376021SP >	SP0498	PK096 / MK121	⊗ ⊕
91-92	320i, 325i & 325td Imported M. Tech. (E36)	G8615 G8616 *4 *15	742034SP 742035SP *4 *15	SP0100 = 316, 318 "SP0166" = 320, 323, 325	PK012 / MK045	(long neck)	GT2043	376021SP >	SP0498	PK096 / MK121	⊗ ⊕
90-99	E36 M Tech (BMW Motorsport)	—	"742030S P" "742031SP" *4 *15	—	PK012 / MK045		"G1365"	"376018SP" >	—	PK096 / MK121	⊗ ⊕
90-99	M3 (E36)	—	—	—	PK012 / MK045		G55016 >	—	—	PK096 / MK121	⊗ ⊕
E36											
93-99	M3 (E36)	—	—	—	PK012 / MK045		G55016 >	—	—	PK096 / MK121	⊗ ⊕
93-99	323i, 325i & 328i Cabriolet M Tech) (E36)	—	742032SP 742033SP *4 *15	SP0100 = 316, 318 "SP0166" = 320, 323, 325	PK012 / MK045		GT2043	376021SP >	SP0498	PK096 / MK121	⊗ ⊕
E46											
99-Sept'01	318i & 320d (E46) M3, cabrio, coupe, & sport susp)	G16772 G16773 G8613 G8614	742004SP 742005SP *15	SP2274 = 318i SP2275 = 320d	PK012 / MK136	Check OE #s	23468 > G1235	376003SP >	SP2277 > SN2277	PK096 / MK121	⊗ ⊕
99-Sept'01	320i, 323i, 325i & 328i (E46) M3, cabrio, coupe & sport susp)	G8613 G8614 *15	—	SP2275	PK012 / MK136	Check OE #s	23468 > G1235	376003SP >	SP2277 > SN2277	PK096 / MK121	⊗ ⊕
99-April'01	330i & 330d (E46) M3, cabrio, coupe & sport)	G8613 G8614 *15	—	SP2282	PK012 / MK136	Check OE #s	G1235	376003SP >	SP2277 > SN2277	PK096 / MK121	⊗ ⊕
Sept'01- Feb'05	318i (E46) : Compact, M3, cabrio, coupe, sport susp & S/W)	G16772 G16773 G8613 G8614	742008SP 742009SP *15	SP2274	PK012 / MK136	Check OE #s	23468 > G1235	376003SP >	SP2277 > SN2277	PK096 / MK121	⊗ ⊕
Sept'01- Feb'05	320i, 320d, 325i (E46) Compact, M3, cabrio, coupe & sport susp)	G7513 G7514 G8613 G8614	742010SP 742011SP *15	SP2275	PK012 / MK136	Check OE #s	23468 > G1235	376003SP >	SP2277 > SN2277	PK096 / MK121	⊗ ⊕
April'01- Feb'05	330i & 330d (E46) 325ti compact M3, cabrio, coupe, sport susp & S/W)	G8294 G8295	742012SP 742013SP *15	SP2282	PK012 / MK136	Check OE #s	G1235	376003SP >	SP2277 > SN2277	PK096 / MK121	⊗ ⊕
98-05	E46 – Sport Pack II for BMW OE Sport Susp Ci	G8294 G8295	"E4983" > / 742012SP 742013SP *15	—	PK012 / MK136	Check OE #s	G1235	376077SP > 376003SP >	—	PK096 / MK121	⊗ ⊕

Key

*	See important installation information on inside front cover
!	Excluding self-levelling suspension
"..."	Special order – phone 010 900 1850. 6-12 week waiting period

~	Imported
#	Internal bump stop
⊕	Steering damper

- It is recommended that all new shock absorbers are fitted in pairs
- Do not mix gas and non-gas units on the same axle
- **Bold** part numbers indicate heavy-duty shocks
- Underlined part numbers indicate parts not immediately available
- *Italic* part numbers followed by > indicate parts to be discontinued

Passenger and light commercial

Part number [alphabetical listing]

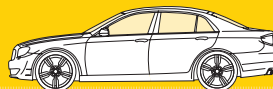

Year	Application	Front					Rear				
		Entry shocks	Premium shocks	Springs	Protection kits/ Mounting kits	Mounting information	Entry shocks	Premium shocks	Springs	Protection kits/ Mounting kits	Mounting information
BMW continued											
3 Series continued											
E46 Compact											
Nov 01-05	318ti Compact (E46) Sport susp	G16772 R > G16773 L > G8613 R G8614 L	742008SP R > 742009SP L > *15	SP2274	PK012 / MK136		G1235	376003SP >	SP2277 > SN2277	PK096 / MK121	⊗ ⊕
Nov 01-05	325ti Compact (E46) Sport susp	G8294 R G8295 L	742012SP R > 742013SP L > *15	SP2275	PK012 / MK136		G1235	376003SP >	SP2277 > SN2277	PK096 / MK121	⊗ ⊕
E46											
00-05	318i Touring (E46) Sport susp	G16772 R > G16773 L > G8613 R G8614 L	742004SP R > 742005SP L > *15	SP2274	PK012 / MK136		G1235	376003SP >	—	PK096 / MK121	⊗ ⊕
00-05	320i, 325i Touring (E46) Sport susp	G8613 R G8614 L *15	—	SP2275	PK012 / MK136		G1235	376003SP >	—	PK096 / MK121	⊗ ⊕
E46											
00-07	M3 (E46)	—	—	—	—		—	—	—	—	⊗ ⊕
00-06	330Ci Cabriolet Sport Pac II & M3 (E46)	G8613 R G8614 L *15	—	SP2282	PK012 / MK136		23919 > G1235	376003SP >	SP2277 > SN2277	PK096 / MK121	⊗ ⊕
99-Sept 01	325Ci, 330Ci Coupe Sport Pac II & M3 (E46)	G7513 R > G7514 L > G8613 R G8614 L	742010SP R > 742011SP L > *15	SP2275 = 325i SP2282 = 330i	PK012 / MK136		23919 > G1235	376003SP >	SP2277 > SN2277	PK096 / MK121	⊗ ⊕
Oct 01-06	325Ci, 330 Ci Coupe Sport Pac II & M3 (E46)	G8294 R G8295 L	742012SP R > 742013SP L > *15	SP2275 = 325i SP2282 = 330i	PK012 / MK136		23919 > G1235	376003SP >	SP2277 > SN2277	PK096 / MK121	⊗ ⊕
00-06	325Ci, 330 Ci Coupe Sport Pac II M3 (E46)	G8294 R G8295 L	"E4983" > *15 / 742012SP R > 742013SP L > *15	—	PK012 / MK136		G1235	376077SP > 376003SP >	—	PK096 / MK121	⊗ ⊕
E90 & E91											
March '05-12	3 series (E90 & E91) 320i, 320d, 323i, 325i, 330d, 330i & 335i Sport susp, M3, Cabrio & Coupe)	G8212 R > G8213 L > G8292 R G8293 L	742040SP R > 742041SP L >	SP3430 > SE3430 = 318, 320, 323 SP3432 > SP3431 = 325, 330	PK012 / MK136	 Check OE#'s: 31316768916 / 31316771178 / ...553 / ...723 / 31316772918 / ...921 / ...31316780075 / ...782329 / ...783988 / 783995	G2232	—	SP3479 = Sedan SP3482 > = S/W	PK167 / *MK379 OR *MK380 (*Compare MK to photos prior to ordering)	⊥ ⊤ Check OE#'s: 33526768917 / ...771555 / ...725 / ...772916 / ...926 / ...780077 / ...195 / ...782859 / ...783989 / ...997
March '05-12	3 series Sport susp, (E90 & E91) 320i, 320d, 323i, 325i, 330d, 330i & 335i M3, Cabrio & Coupe)	G8292 R G8293 L	742069SP R > 742070SP L >	—	PK012 / MK136		G2232	—	—	PK167 / *MK379 OR *MK380 (*Compare MK to photos prior to ordering)	⊥ ⊤

Key

*	See important installation information on inside front cover
!	Excluding self-leveling suspension
"..."	Special order – phone 010 900 1850. 6-12 week waiting period

~	Imported
#	Internal bump stop
⊕	Steering damper

- It is recommended that all new shock absorbers are fitted in pairs
- Do not mix gas and non-gas units on the same axle
- **Bold** part numbers indicate heavy-duty shocks
- Underlined part numbers indicate parts not immediately available
- *Italic* part numbers followed by > indicate parts to be discontinued

Passenger and light commercial

Part number [alphabetical listing]

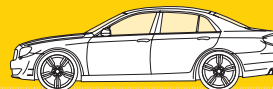

Year	Application	Front					Rear				
		Entry shocks	Premium shocks	Springs	Protection kits/ Mounting kits	Mounting information	Entry shocks	Premium shocks	Springs	Protection kits/ Mounting kits	Mounting information
BMW continued											
3 Series continued											
E90 E92 E93											
08-12	M3 (E90)	—	—	—	—		—	—	—	—	—
07-12	330i, 335i Cabriolet M3, Coupe (E93)	G8292 G8293 (Sport susp)	742040SP > 742041SP > (Std susp) 742069SP > 742070SP > (Sport susp)	—	PK012 / MK136		G2232 (Std & Sport susp)	—	—	PK167 / *MK379 OR *MK380 OR *MK444 (*Compare orig MK to photos prior to ordering, All bearings)	⊥ T
07-12	320i, 325i, 335i Coupe M3, Cabrio (E92)	G8292 G8293 (Std & Sport susp)	742069SP > 742070SP > (Std & Sport susp)	—	PK012 / MK136		G2232 (Std & Sport susp)	—	—	PK167 / *MK379 OR *MK380 OR *MK444 (*Compare orig MK to photos prior to ordering, All bearings)	⊥ T
		MK379			MK380			MK444			
F30 F31											
13-Feb 18	3 Series F30 sedan GT Gran Turismo 5 door liftback/hatch, S/W, Sport susp, Elec Susp, X-Drive and M series) Gen 6	—	742132SP	—	PK372 / MK415		—	376211SP !	—	PK379 / MK446A	⊥ ○
13-Feb 18	3 Series F30 sedan Sport Susp & F31 S/W std & Sport GT Gran Turismo 5 door liftback/hatch, and M series) Gen 6	—	742133SP	—	PK372 / MK415		—	376211SP !	—	PK379 / MK446A	⊥ ○
F80 M3											
13-18	F80 M3 sedan	—	—	—	—	—	—	—	—	—	—
F34 Grand Turismo											
13-on	F34 Gran Turismo GT 3 series 5 door liftback/hatch Sedan, station wagon, Sport susp and M series)	—	742132SP	—	PK372 / MK415		—	376211SP ! Std susp OR 376212SP Sport susp	—	PK379	⊥ ○
G20											
March 19-on	3 Series G20 sedan GT Gran Turismo 5 door liftback/hatch, S/W, Sport susp, Elec Susp, X-Drive and M series) Gen 7	—	—	—	—	—	!	!	—	PK379 (Elec susp)	—
March 19-on	3 Series G20 sedan Sport Susp GT Gran Turismo 5 door liftback/hatch, and M series) Gen 7	—	—	—	—	—	!	!	—	PK379 (Elec susp)	—

Key	
*	See important installation information on inside front cover
!	Excluding self-levelling suspension
"..."	Special order – phone 010 900 1850. 6-12 week waiting period

~	Imported
#	Internal bump stop
	Steering damper

- It is recommended that all new shock absorbers are fitted in pairs
- Do not mix gas and non-gas units on the same axle
- **Bold** part numbers indicate heavy-duty shocks
- Underlined part numbers indicate parts not immediately available
- *Italic* part numbers followed by > indicate parts to be discontinued

Passenger and light commercial

Part number [alphabetical listing]

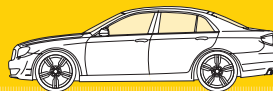

Year	Application	Front					Rear					
		Entry shocks	Premium shocks	Springs	Protection kits/ Mounting kits	Mounting information	Entry shocks	Premium shocks	Springs	Protection kits/ Mounting kits	Mounting information	
BMW continued												
4 Series												
F32 F33 F36												
13-on	4 Series Coupe, Gran Coupe (liftback) & Cabriolet SDrive Sport susp, M4, Elec susp & Grand Coupe XDrive	—	742132SP	—	PK372 / MK415		—	376211SP ! F33 Cabrio	—	PK379 / MK446A	⊥ ○	
13-on	4 Series Coupe, Gran Coupe (liftback) & Cabriolet Sport susp SDrive elec susp, XDrive & M4	—	742133SP	—	PK372 / MK415		—	376212SP ! F33 Cabrio	—	PK379 / MK446A	⊥ ○	
13-on	M4 Coupe, Cabriolet & GTS Xdrive	—	—	—	PK372 / MK415		—	376212SP !	—	PK379 / MK446A	⊥ ○	
5 Series												
E12												
74-75	518, 520 (E12)	"MG971"	—	—	PK012		—	—	—	"PK019"	⊥ ⊕	
74-76	525, 528 (E12) – 518, 520 '76 model only	"MG971"	—	—	PK012		—	—	—	"PK019"	⊗ ⊕ S/pan unit	
77-Mid 85	518, 520, 525, 528 (E12)	"MG971"	—	—	PK012		—	—	—	"PK019"	⊗ ⊕ S/pan unit	
E28												
Mid 85-89	518, 520, 525, 525e, 528 & 535e (E28) M Tech	GT0118 >	—	—	PK012 / MK036		"26624"	—	—	"PK019"	⊗ ⊕ S/pan unit	
E34												
88-95	5 Series (E34) Sport Susp, M Tech & M5) Note: See the INFO column for front shock selection details. Check OE #'s	MG318 *4 (12mm rod OD & short "neck") or MG308 > *4 (12mm rod OD & long "neck")	—	—	PK012 / MK036 (MK036 for MG318 only, For MG308 use the OE BMW mounting)	MG318 OE #'s = 31321135416 / 31321135674 / 31321135858 / 31321092283 / 31321139407 / 31321139410 / 31321134565 / 31321135675 / 31321134573 / 31321091000 MG308 OE #'s = 31321134565 / 31321134573 / 31321135675 / 31211134565 / 31322980538 MG318 has a 12mm OD rod thread and a short 16mm "neck" / MG308 has a 12mm OD rod thread & long 41mm "neck"	26635	—	—	"MK122"	⊗ ⊕	
Mid 90-95	5 Series (E34) Std. & Sport Susp M Tech & M5) Note: See the INFO column for front shock selection details. Check OE numbers	"MG312" > *4 (14mm rod OD & long "neck")	—	—	PK012 / MK036	OE #'s = 31321139408 / 31321139409 / 31321092284 / 31321139411 E3805 & MG312 have a 14mm OD rod thread and a long 44mm "neck"	26635	—	—	"MK122"	⊗ ⊕	
E39												
96-'03	520i, 523i, 525i, 528i, 530d & 530i (E39) 535i, 540i, Sport susp, M5, Air Susp, M Tech, Elec susp & S/W	G8427 G8428	742026SP > 742027SP <	—	"PK125" / MK136		—	376033SP !	—	"MK123"	⊗ ⊕	
96-'03	535i & 540i (E39) "protection", M5, Air Susp, M Tech, Sport susp, Elec susp & S/W	—	742065SP > 742066SP <	—	"PK125" / MK136		Shorter than 742026SP (R) / 742027SP (L)	—	376033SP !	—	"MK123"	⊗ ⊕
E39												
97-'03	5 Series Touring S/W 540i and Sport susp	G8427 G8428	742026SP > 742027SP <	—	"PK125" / MK136		—	376020SP !	—	"MK162"	⊗ ⊕	

Key

*	See important installation information on inside front cover
!	Excluding self-levelling suspension
"..."	Special order – phone 010 900 1850. 6-12 week waiting period

~	Imported
#	Internal bump stop
⊕	Steering damper

- It is recommended that all new shock absorbers are fitted in pairs
- Do not mix gas and non-gas units on the same axle
- **Bold** part numbers indicate heavy-duty shocks
- Underlined part numbers indicate parts not immediately available
- *Italic* part numbers followed by > indicate parts to be discontinued

Passenger and light commercial

Part number [alphabetical listing]

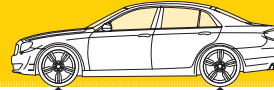

Year	Application	Front					Rear				
		Entry shocks	Premium shocks	Springs	Protection kits/ Mounting kits	Mounting information	Entry shocks	Premium shocks	Springs	Protection kits/ Mounting kits	Mounting information
BMW continued											
5 Series continued											
E60											
Nov'03- May'10	All E60 5 Series sedan (EXC) Touring S/W, M5 & Sport susp)	-	742016SP R 742017SP L	Petrol (EXC) 540i, 545i & 550i = "SP3591" / Diesel + 540i, 545i & 550i = "SP3593"	PK176 / MK136		-	376029SP !	"SP3596"	"PK166" / "MK279"	⊥ ⊕
Nov'03- May'10	All E60 5 Series sedan Sport susp (EXC) Touring S/W, & M5)	-	742020SP R 742021SP L	-	PK176 / MK136		-	"376016SP"	-	"PK166" / "MK279"	⊥ ⊕
E61											
04-May'10	All E61 5 Series Touring (EXC) Sedan, M5 & Sport susp)	-	742018SP R 742019SP L	-	PK176 / MK136		-	"376204SP"	-	"PK177" / "MK279"	⊥ ⊕
F10											
June'10- 16	All F10 5 Series sedan (EXC) Sport susp & M-Tech (EXC) GT liftback, F11 Touring S/W, elec susp & M5)	-	376219SP R 376220SP L	-	"PK374" / "MK390"	⊥ ⊗	-	376014SP !	-	"PK377" / "MK397"	⊥ ⊕
F07 GT Gran Turismo											
June'10- 16	All F07 Gran Turismo GT 5 Series Liftback (EXC) Sedan, F11 Touring S/W, xDrive & M5)	-	-	-	"PK374" / "MK390"	⊥ ⊗	-	376015SP !	-	"MK391"	⊥ ⊕
G30											
16-on	All G30 5 Series sedan (EXC) Sport susp, M-Tech, GT liftback, Touring S/W, elec susp & M5)	-	-	-	"MK519"	-	-	!	-	"MK513"	-
6 Series											
E24											
76-6/78	630CS, 633CSi, 635CSi (E24)	-	-	-	PK012		-	-	-	"PK019"	⊗ ⊕
6/78-5/82	628CSi, 630CSi, 633CSi, 635CSi (E24)	"MG971"	-	-	PK012		-	-	-	"PK019"	⊗ ⊕
6/82-'90	628CSi, 635CSi (E24) (EXC) elec suspension)	GT0118 >	-	-	PK012 / MK036		"26624" !	-	-	"PK019"	⊗ ⊕
E63 E64											
04-10	645i, 650i Coupe & Cabrio (EXC) M6)	-	-	-	MK136 (INC) bearings)	-	-	-	-	"MK279" (EXC) bearings)	-
F12 F13 FO6											
11-18	640i, 645i, 650i Coupe (F13), Cabrio (F12) & Gran Coupe (FO6) (EXC) M6)	-	-	-	"MK390" (EXC) bearings)	-	-	-	-	-	-
G32 Gran Turismo											
18-on	640, 650 Gran Coupe (G32), 6 Series Gran Turismo, 5 door fastback (EXC) M6)	-	-	-	-	-	-	-	-	-	-
7 Series											
E23											
78-87	728, 730, 733, 735 (E23)	"MG971"	-	-	PK012		-	-	-	-	⊗ ⊕
84-86	745i (E23)	"MG971"	-	-	PK012		-	-	-	-	-
E32											
86-88	730, 735 (E32) (EXC) elec suspension & M Tech)	-	-	-	PK012		"26634" !	-	-	"MK124"	⊗ ⊕
89-90	730, 735 (E32) (EXC) elec suspension & M Tech)	-	-	-	PK012		"26634" !	-	-	"MK124"	⊗ ⊕
91-94	730, 735 & 740 (E32) (EXC) 750 & elec suspension & M Tech)	-	-	-	PK012		"26634" !	-	-	"MK124"	⊗ ⊕
E38											
94-02	728i, 730d, 735i, 740i & 750i & Limo (E38) (EXC) Air Susp. & elec susp)	-	E4608 - / 742059SP R > 742060SP L >	-	PK012 / "MK135"		-	E2030 > !	-	"MK189"	⊗ ⊕

Key

*	See important installation information on inside front cover
!	Excluding self-levelling suspension
"..."	Special order - phone 010 900 1850. 6-12 week waiting period



-	Imported
#	Internal bump stop
⊕	Steering damper

- It is recommended that all new shock absorbers are fitted in pairs
- Do not mix gas and non-gas units on the same axle
- **Bold** part numbers indicate heavy-duty shocks
- Underlined part numbers indicate parts not immediately available
- *Italic* part numbers followed by > indicate parts to be discontinued

Passenger and light commercial

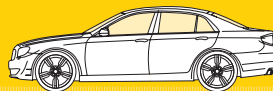
Part number [alphabetical listing]



Year	Application	Front					Rear				
		Entry shocks	Premium shocks	Springs	Protection kits/ Mounting kits	Mounting information	Entry shocks	Premium shocks	Springs	Protection kits/ Mounting kits	Mounting information
BMW continued											
7 Series continued											
E65											
Mid 02- Feb'09	730d, 735i, 740i, 745i, 750i (E65)	-		-			-	-	-	"MK279"	⊥ ⊕
F01											
09-Jan 16	7 Series (F01) F02 Limo	-		-			-	!	-		
G11											
Feb 16-April 22	7 Series (G11) G12 Limo	-		-			-	!	-		
G70											
May '22-on	7 Series (G70) i7 elec	-		-			-	!	-		
i3											
15-on	i3 Hatch urban electric vehicle (i01)	-		-	"PK469"		-		-		
i7											
23-on	i7 electric sedan	-		-			-		-		
iX1											
2022-on	iX & iX1 electric SUV										
iX3											
2022-on	iX3 electric SUV										
X1 E84											
10-Oct 15	X1 (E84) sDrive FWD	-	<u>D0038</u> > <u>D0038R</u> / <u>D0039L</u>	"SP4214"	PK176 / MK136 		-	<u>D8080</u> > <u>D8080S</u>	"SP4216"	PK167 / *MK379 OR *MK380 OR *MK444 All	⊥ T
10-Oct 15	X1 (E84) xDrive AWD	-	<u>D0036</u> > <u>D0036R</u> / <u>D0037L</u>	"SP4215"	PK176 / MK136 		-	<u>D8080</u> > <u>D8080S</u>	"SP4216"	PK167 / *MK379 OR *MK380 OR *MK444 All	⊥ T
<div style="display: flex; justify-content: space-around; align-items: center;"> <div style="text-align: center;">  MK379 </div> <div style="text-align: center;">  MK380 </div> <div style="text-align: center;">  MK444 </div> </div>											
X1 F48											
Nov 15- Oct 22	X1 (F48) sDrive FWD & xDrive AWD 1.8i, 2.0i, 2.0d LWB F49	<u>G8640</u>	-		PK477 / MK450		-	<u>376260SP</u>		PK476 / MK446A	⊥ ⊕
X1 U11											
Nov 22-on	X1 (U11) sDrive 1.8i, 18d FWD LWB U12, iX & iX1	-					-				

Key

*	See important installation information on inside front cover
!	Excluding self-levelling suspension
"..."	Special order – phone 010 900 1850. 6-12 week waiting period

~	Imported
#	Internal bump stop
⊕	Steering damper

- It is recommended that all new shock absorbers are fitted in pairs
- Do not mix gas and non-gas units on the same axle
- **Bold** part numbers indicate heavy-duty shocks
- Underlined part numbers indicate parts not immediately available
- *Italic* part numbers followed by > indicate parts to be discontinued

Passenger and light commercial

Part number [alphabetical listing]

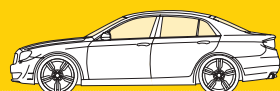

Year	Application	Front					Rear				
		Entry shocks	Premium shocks	Springs	Protection kits/ Mounting kits	Mounting information	Entry shocks	Premium shocks	Springs	Protection kits/ Mounting kits	Mounting information
BMW continued											
X2 F39											
Nov 18-on	X2 (F39) 1.8i, 2.0i sDrive FWD & 2.0d xDrive AWD	G8640 R G8641 L	—	—	PK477 / MK450		—	376260SP	PK476 / MK446A	⊥ ⊕	
X3 E83											
04-10	X3 (E83) 2.5, 3.0 & 2.0 d MCI Sport susp SXI elec susp	—	D0405 > D0405 R D0406 L	SP3617	PK089 > / PK189 / MK136		—	D4005S!	SN3619	⊥ ⊕ (Groove on OE bracket must be aligned with dimples on the Monroe shock)	
X3 F25											
11-17	X3 (F25) 2.0i, 2.8i, 3.0i, 3.5i & 2.0d, 30d MCI Sport susp sDrive & xDrive AWD SXI elec susp	—	D0414 R D0415 L	SP4007 SXI 3.0 & 3.5 above 150kw	PK373 / MK419		—	D0311S!	SP4008	⊥ ⊕ S/pan unit	
11-17	X3 (F25) Elec susp	—	C2525 R C2526 L	—	—		—	C1532S	—	⊥ ⊕ S/pan unit	
X3 G01											
18-on	X3 (G01) 3.0i, 2.0d & 30d sDrive & xDrive AWD SXI elec susp & M40i MCI 2021 facelift	—	—	—	—	—	—	!	—	—	
X4 F26											
14-Sept 18	X4 (F26) 2.0i, 2.8i, 3.5i, 2.0d & 3.0d MCI Sport susp xDrive AWD SXI elec susp & M40i	—	D0414 R D0415 L	—	PK373 / MK419		—	D0311S!	—	PK376	
14-Sept 18	X4 (F26) Elec susp	—	C2525 R C2526 L	—	—		—	C1532S	—	⊥ ⊕ S/pan unit	
X4 G02											
Oct 18-on	X4 (G02) 2.0i & 2.0d MCI Sport susp xDrive AWD SXI elec susp & M40i	—	—	—	—	—	—	!	—	—	
X5 E53											
01-06	X5 (E53) 3.0i, 3.0d, 4.4iV8, 4.8 V8 4x4, MCI rear air susp SXI elec or self leveling susp & SXI front air susp	—	D0407 > D0407 R D0408 L	"SP3621"	PK151 / MK273	 SXI front air susp	—	D4003 > D4003S!	"SP3622"	PK152 / MK274	⊥ ⊕
X5 E70											
07-13	X5 (E70) 3.5i xDrive, 5.0i V8 xDrive, 3.0d xDrive, 4.0d xDrive 4x4, MCI sport susp SXI Mtech M5.0d, Elec or Self Leveling susp	—	D0305S	—	MK392		—	D0306R / D0307L!	—	—	⊥ ⊕ SXI Self Leveling rear susp *Longer than D0309/10
07-13	X5 (E70) 3.5i xDrive, 5.0i V8 xDrive, 3.0d xDrive, 4.0d xDrive 4x4, MCI Self Leveling & sport susp SXI Mtech M5.0d or Elec susp	—	D0305S	—	MK392		—	D0309 > D0309R / D0310L	—	—	⊥ ⊕ MCI Self Leveling rear susp *Shorter than D0306/7
X5 F15											
13-18	X5 (F15) 3.5i xDrive, 5.0i V8 xDrive, 3.0d xDrive, 4.0d xDrive 4x4, MCI Self Leveling & sport susp SXI Mtech M50d or Elec susp	G7944	—	—	MK456		G7931 R G7932 L	—	—	—	⊥ ⊕
X5 G05											
19-on	X5 (G05) 3.0d xDrive 4x4, MCI Self Leveling & sport susp SXI Mtech M50d or Elec susp	—	—	—	—	—	—	—	—	—	—
X6 E71											
09-Jan15	X6 (E71) Cross-over SUV SXI Mtech M5.0d, X6M, Elec or Self Leveling susp	—	D0305 > D0305S	—	MK392		—	D0306R / D0307L!	—	—	⊥ ⊕ SXI Self Leveling rear susp *Longer than D0309/10
09-Jan15	X6 (E71) Cross-over SUV MCI Self Leveling SXI Mtech M5.0d, X6M or Elec susp	—	D0305 > D0305S	—	MK392		—	D0309 > D0309R / D0310L	—	—	⊥ ⊕ MCI Self Leveling rear susp *Shorter than D0306/7

Key

*	See important installation information on inside front cover
!	Excluding self-leveling suspension
"..."	Special order – phone 010 900 1850. 6-12 week waiting period

~	Imported
#	Internal bump stop
⊕	Steering damper

- It is recommended that all new shock absorbers are fitted in pairs
- Do not mix gas and non-gas units on the same axle
- **Bold** part numbers indicate heavy-duty shocks
- Underlined part numbers indicate parts not immediately available
- *Italic* part numbers followed by > indicate parts to be discontinued

Passenger and light commercial

Part number [alphabetical listing]

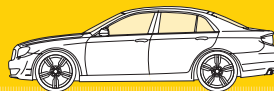

Year	Application	Front					Rear				
		Entry shocks	Premium shocks	Springs	Protection kits/ Mounting kits	Mounting information	Entry shocks	Premium shocks	Springs	Protection kits/ Mounting kits	Mounting information
BMW <i>continued</i>											
X6 F16											
Feb'15-on	X6 (F16) Cross-over SUV	G7944		-	MK456		G7931 G7932		-		
Z3 E36/8 E36/7											
97-'03	Z3 1.8, 1.9, 2.8 & 3.0 (E36) M-Tech & M Coupe	-	742038SP 742039SP	-	PK012 / MK045		-	376032SP	-	PK096 / MK121	
Z4 E86 E85											
04-09	Z4 2.0, 2.5 & 3.0 M-Tech 3.2M & Sport susp)	G8163 G8164		-	PK012 / MK045		G1136		-	/ MK121	
Z4 E89											
09-16	Z4 (E89) sDrive, 2.0i, 23i, 2.8i, 30i, 35i, 353is, Sport susp & M-Tech)	-		-	/ MK045		-		-	/ MK121	
Z4 G29											
18-on	Z4 (G29) M40i	-	-	-			-	-	-		

For CAM ... see BAW

CHERY											
QQ3											
08-on	QQ3 (S11) 0.8, 1.1	11377 11378	-	-	PK054 > PK004 / MK410		R1643A	-	-	PK385	
Tiggo & Tiggo 3											
08-Jan'14	Tiggo	-	D0011R / D0012L	-	-		-	D8020 > D8020S	-	-	 Slightly shorter & firmer than OE/ Additional washer to be fitted over the top rod spacer
Feb'15-20	Tiggo 3	-		-			-		-		
Tiggo 4 Pro											
21-on	Tiggo 4 Pro 1.5		-	-				-	-		
Tiggo 7 Pro											
22-on	Tiggo 7 Pro 1.5		-	-				-	-		
Tiggo 8 Pro & Pro Max											
22-on	Tiggo 8 Pro & Pro Max 1.6T & 2.0Tgd		-	-				-	-		

CHEVROLET (Also see Opel)											
2500 / 3800 / 4100											
72-78	2500, 3800 & 4100 Sedan	V1063	-	-	-		R1566	-	-	-	
75-78	2500 & 3800 S/Wagon	V1063	-	-	-		GA2056 > *7	-	-	-	
Aveo											
03-11	Aveo gen one & two (T200 & T250 facelift)	R7213 R7214	-	SP3231	MK275		-	5794ST	SP3232	PK078 / MK276	
Captiva											
07-18	Captiva SUV 4x2 & 4x4 Gen 1 facelift (C100) Elec or air susp, or self leveling rear ie on Diesel	-	D0409 > D0409R / D0410L	"SP3810" (2.4) / "SP3811" (2.0d, 3.0, 3.2)	-		-	D8079S !	"SP3812"	-	
Chevaire / Ascona											
76-82	Chevaire & Ascona Sedan	-	-	-	-		R1566	-	-	-	
Constantia / Kommando											
69-72	Constantia & Kommando	-	-	-	-		"R3216" ~	-	-	-	
72-79	Constantia, Kommando & De Ville Sedan & S/Wagon	V1063	-	-	-		"R3216" ~	-	-	-	

Key

*	See important installation information on inside front cover
!	Excluding self-leveling suspension
"..."	Special order - phone 010 900 1850. 6-12 week waiting period

~	Imported
#	Internal bump stop
	Steering damper

- It is recommended that all new shock absorbers are fitted in pairs
- Do not mix gas and non-gas units on the same axle
- **Bold** part numbers indicate heavy-duty shocks
- Underlined part numbers indicate parts not immediately available
- *Italic* part numbers followed by > indicate parts to be discontinued

Passenger and light commercial

Part number [alphabetical listing]

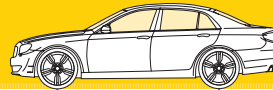

Year	Application	Front					Rear				
		Entry shocks	Premium shocks	Springs	Protection kits/ Mounting kits	Mounting information	Entry shocks	Premium shocks	Springs	Protection kits/ Mounting kits	Mounting information
CHEVROLET continued											
Corsa											
Aug'04-11	Corsa Utility LDV	G77263 R G77264 L	–	–	PK173 / MK149	 (PK173 – no dust cover)	G12082	–	–	–	⊕ ⊖
For new Corsa bakkie ... see Utility											
Cruze											
09-18	Cruze J300 (gen one) & J400 (gen two) Sedan & Hatch Sport susp, OPC	G8195 R G8196 L	–	"SP4010" (Gen one 1.4 & 1.6) / "SP4009" (Gen one 1.7 & 2.0)	PK447 / MK381		G1154	–	"SP3987" Gen one	PK361 / MK472	⊥ ○
El Camino											
68-72	El Camino	–	–	–	–	⊥ ⊕	GA2068 > / "R3216" –	–	–	–	⊥ ○
72-78	El Camino 6 or 8 Cylinder & El Toro	V1063	–	–	–	⊥ ⊕	–	–	–	–	⊕ ⊖
K-1500 / K2500											
92-99	K-1500 1/2 ton pick-up ext cab 4x4 (Ex-Namibian Govt) WZ71 off road package	–	–	–	–	⊕ ⊖	–	911044MM >	–	–	⊕ ⊖
92-99	K-2500 3/4 ton pick-up 4x4 (Ex-Namibian Govt) 8600 GWW	–	–	–	–	⊕ ⊖	–	911044MM >	–	–	⊕ ⊖
LUV											
72-78	LUV	GA2009 > / GT2009	–	–	–	⊥ ⊕	M8038	–	–	–	○ ○
Opra											
03-09	Opra J200	G8089 R G8090 L	–	"SP0219"	"PK282"		G7288 R G7289 L	–	"SP3497"	"PK283" / "MK505"	
Orlando											
11-18	Orlando MPV (J309)	G8195 R G8196 L	–	–	MK381		G1226	–	–	–	⊥ ○
Rekord / Commodore											
78-92	Rekord & Commodore Sedan	GT0116	–	–	PK005		R1566	–	–	–	⊥ ⊕
78-89	Rekord & Commodore S/Wagon	GT0116	–	–	PK005		GA2056 > *7	–	–	–	⊥ ○
Senator											
79-82	Senator	GT0116	–	–	PK005		–	–	–	–	⊥ ○
Sonic / Aveo											
11-18	Sonic sedan & hatch 1.4 & 1.6 (T300) EXCL RS 1.4 Turbo	G7468 R G7469 L	–	SP4063 (1.4) / SP4065 (1.6)	–		G1037	376130SP >	SP4067 / SP4066	PK018 / MK384R & MK385L	⊥ ○
Spark (Beat in India)											
03-05	Spark (M100, M150)	11377 R 11378 L	–	"SP0385"	PK054 > PK004 / MK410		R1643A	–	"SP0723"	PK385	○ ○
05-July'10	Spark (M200, M250) Lite 2010-on	G7097 R G7098 L	–	"SP3653"	MK275		G1084	–	"SP3654"	PK385	○ ○
Aug'10-17	Spark LITE (M200, M250)	G7097 R G7098 L	–	"SP3653"	MK275		G1084	–	"SP3654"	PK385	○ ○
Aug'10-17	Spark (M300) EXCL Lite	G7483 R G7484 L	–	SP4013	–	 (Ind)	G1241	–	SP4014	–	⊥ ○
Trailblazer											
12-18	Trailblazer SUV 7 seater (RG)	M8088	–	–	–	⊥ ○ S/pan unit / Reuse OE washers	AU160939	–	–	–	○ ○ (no s/pan)
Utility											
11-18	Utility LDV Petrol EXCL Diesel front – will fit but may be a bit soft – Rear is ok for the Diesel / EXCL Sport susp rear	GT7417	–	–	–		GT2082	–	–	–	⊕ ⊖
Vivante											
10/03-05	Vivante MPV (Was Tacuma)	–	–	–	PK004		"G43153"	–	–	–	⊕ ⊖

Key	
*	See important installation information on inside front cover
!	Excluding self-levelling suspension
"..."	Special order – phone 010 900 1850. 6-12 week waiting period

~	Imported
#	Internal bump stop
⊕	Steering damper

- It is recommended that all new shock absorbers are fitted in pairs
- Do not mix gas and non-gas units on the same axle
- **Bold** part numbers indicate heavy-duty shocks
- Underlined part numbers indicate parts not immediately available
- *Italic* part numbers followed by > indicate parts to be discontinued

Passenger and light commercial

Part number [alphabetical listing]

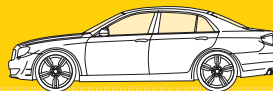

Year	Application	Front					Rear				
		Entry shocks	Premium shocks	Springs	Protection kits/ Mounting kits	Mounting information	Entry shocks	Premium shocks	Springs	Protection kits/ Mounting kits	Mounting information
CHRYSLER											
Crossfire											
04-08	Crossfire	G43141	—	—	—	⊥ ⊕	G43142	—	—	—	⊥ ⊕

For Chrysler Jeep ... see section J

For Jeep CJ ... see Willys at the end of the alphabetical section, after Volvo

Neon											
96-99	Neon 1.8 & 2.0, SE, LE.(PL) Gen 1	—	—	—	—	⊥	—	—	—	—	⊥
'00-07	Neon 1.6 & 2.0 Gen 2	—	—	—	—	⊥	—	—	—	—	⊥
PT Cruiser											
01-10	PT Cruiser (cabriolet)	—	"71592"	—	—	⊥	—	"5989ST"	—	—	○ / ○
Voyager											
95-00	Voyager 2.0 SWB & Grand Voyager (GS) 3.3 V6 & 2.5 TD LWB Rear Nivomat leveling susp & 4x4)	—	71964	—	"MK262"	⊥	—	"37123ST" *6 ! self leveling systems)	—	—	⊕ ⊕
01-07	Voyager 2.0 & 2.4 SWB; & Grand Voyager 2.8, 3.3 V6 & 2.5TD LWB Rear Nivomat leveling susp & AWD 4x4)	—	71572	—	"MK278"	⊥	—	"37123ST" *6 ! self leveling systems)	—	—	⊕ ⊕
08-16	All Voyager; and Grand Voyager (Check for Rear Nivomat self leveling susp)	—	71128ST	—	—	⊥	—	37290ST ! self leveling systems) / 58648ST self leveling systems)	—	—	⊕ ⊕ Check for Rear Nivomat self leveling susp Note 58648ST will not adjust height, but includes coilover spring

CITROEN											
Berlingo											
96-02	Berlingo Multispace MPV & P/Van	R8001 R R8002 L	—	—	PK006 / MK001 (bearing only)	⊥	43104	—	—	—	○ ○
03-April'08	Berlingo Multispace MPV & P/Van	G8007 R G8008 L	—	—	PK006 / "MK097" / MK001 (bearing only)	⊥	43104	—	—	—	○ ○
April'08-18	Berlingo Multispace MPV & P/Van 800kg to 1000kg payload	G7323 R G7324 L	—	—	"PK124" / "MK196"	⊥	G1118	—	—	—	○ ○
C1											
08-14	C1 1.0 & 1.4 Hdi Gen 1 (PM)	G7019 R G7020 L	—	1.0 = "SP3456" 1.4 = "SP3457"	PK178 / MK351	⊥	G1075	—	"SP3458"	PK333 / MK471	⊥ ○
C2											
04-11	C2 1.1i, 1.4i, 1.6i Sport Susp) (JM)	G16449 R G16450 L	—	—	PK104 / MK184 bearings)	⊥	23966	—	—	"PK459"	○ ○
C3											
02-May'06	C3 1.4i, 1.6i manual. 1.6 auto, Hdi 80kw & 82kw 51mm OD strut base (FC / FN)	G16449 R G16450 L	—	SP2347	PK104 / MK184 bearings)	⊥ (Thinner 46mm strut base)	23966	—	SP2351	"PK459"	○ ○
02-May'06	C3 1.6i 16v auto & Hdi 80kw & 82kw 46mm OD strut base. (FC / FN)	G8147 R G8148 L	—	SP2347	PK104 / MK184 bearings)	⊥ (Thicker 51mm OD strut base) OE# 9680262680	23966	—	SP2351	"PK459"	○ ○
June'06-Nov'09	C3 (facelift) 1.4, 1.6 (FC / FN)	G16449 R G16450 L	—	SP2347	PK104 / MK001 (Bearing only) / "MK445" bearing)	⊥	23966	—	SP2351	"PK459"	○ ○

Key

*	See important installation information on inside front cover
!	Excluding self-leveling suspension
"..."	Special order - phone 010 900 1850. 6-12 week waiting period

~	Imported
#	Internal bump stop
⊕	Steering damper

- It is recommended that all new shock absorbers are fitted in pairs
- Do not mix gas and non-gas units on the same axle
- **Bold** part numbers indicate heavy-duty shocks
- Underlined part numbers indicate parts not immediately available
- *Italic* part numbers followed by > indicate parts to be discontinued

Passenger and light commercial

Part number [alphabetical listing]



C

Year	Application	Front					Rear				
		Entry shocks	Premium shocks	Springs	Protection kits/ Mounting kits	Mounting information	Entry shocks	Premium shocks	Springs	Protection kits/ Mounting kits	Mounting information
CITROEN continued											
C3 continued											
02-09	C3 Pluriel & Enterprise models - Convertible (HB)	G16449 R G16450 L	-	-	PK104 / MK184 up to 2004 (incl) bearings)		"23985"	-	-	"PK459"	○ ○
Dec'09-16	C3 II (excl DS3 & Sport) (SC) 46mm OD strut base	G8204 R G8205 L	-	SP3957 > (1.4 & 1.6 VTI 120 excl 1.4 HDi Auto) SP3958 > (1.4 HDi Auto & 1.6 HDi excl 1.6 VTI 120))	PK150 / MK321A (excl) bearing) / MK001 (Bearing only)	 (46mm OD strut base)	G1168	-	SP3959 >	-	○ ○
Dec'09-16	C3 II (excl DS3 & Sport) (SC) 51mm OD strut base	G8206 R G8207 L	-	SP3957 > (1.4 & 1.6 VTI 120 excl 1.4 HDi Auto) SP3958 > (1.4 HDi Auto & 1.6 HDi excl 1.6 VTI 120))	PK150 / MK321A (excl) bearing) / MK001 (Bearing only)	 (51mm OD strut base)	G1168	-	SP3959 >	-	○ ○
16-on	C3 III (SX, SY)	G8649 R G8650 L (lower strut outer diameter is 51mm)	742267SP R 742268SP L (lower strut outer diameter is 47mm)	-	PK410 / MK001 (Bearing only)	 (Select the correct front based on the lower strut outer diameter)	G1257	-	-	-	⊕ ⊕
C3											
10-13	C3 Picasso	G8099 R G8100 L	-	-	PK150 / MK321A (excl) bearing) / MK001 (Bearing only)		G2108	-	-	-	○ ○
C3 Aircross											
19-on	C3 Aircross SUV 1.2, 1.6 (2R, 2C)	G8649 R G8650 L	-	-	PK410 / MK509 (incl) bearings)		G1257	-	-	-	⊕ ⊕
C4											
05-Oct'10	C4 (Gen 1) 1.6i, 2.0i, 2.0HDI (incl) Coupe (excl) DS4 & sport susp)	G7204 R G7205 L	742160SP R > 742161SP L >	SP3391	"PK124" / "MK196"		25504	376085SP >	SP3460	"PK131" / "MK205"	⊥ ○
Nov'10-16	C4 (Gen 2) 1.6i, 2.0, 2.0 HDi (excl) DS4 & sport susp)	G8379 R G8380 L	742186SP R > 742187SP L >	SP3391	"PK124" / MK322		"25505"	376155SP >	SP3460	"PK131"	⊥ ○
C4 Picasso											
08-12	C4 Picasso MPV (incl) air susp	"G7327" R "G7328" L	-	-	"PK124" / "MK196"		"G2226"	-	-	-	○ ○
C4 Aircross											
13-17	C4 Aircross SUV 2.0, 1.6HDI 4x2 & 4x4	G8353 R G8354 L	-	-	MK333 (incl) bearings)		G1321	-	-	-	⊥ ⊕ S/pan unit

Key	
*	See important installation information on inside front cover
!	Excluding self-levelling suspension
"..."	Special order - phone 010 900 1850, 6-12 week waiting period

~	Imported
#	Internal bump stop
⊕	Steering damper

- It is recommended that all new shock absorbers are fitted in pairs
- Do not mix gas and non-gas units on the same axle
- **Bold** part numbers indicate heavy-duty shocks
- Underlined part numbers indicate parts not immediately available
- *Italic* part numbers followed by > indicate parts to be discontinued

Passenger and light commercial

Part number [alphabetical listing]



Year	Application	Front					Rear				
		Entry shocks	Premium shocks	Springs	Protection kits/ Mounting kits	Mounting information	Entry shocks	Premium shocks	Springs	Protection kits/ Mounting kits	Mounting information
CITROEN <i>continued</i>											
C4 Cactus											
13-17	C4 Cactus crossover SUV	—	"742267SP" R "742268SP" L Bottom OE strut OD = 47mm OR "742265SP" R "742266SP" L Bottom OE strut OD = 51mm	—	MK382 [EXC] (bearings) OR MK001 (bearings only)	⚙️ Check bottom OE strut outer diameter for correct part selection	—	"376245SP"	—	—	○ ○
C5											
01-13	NOTE: C5 shocks, spheres and regulators are special order parts from Monroe Europe with an 8 week lead time. Contact customer services for further information should you wish to order.										
C5 Aircross											
19-on	C5 Aircross SUV (A..)	—		—	"MK433" [EXC] (bearings)		—	—	—		
DS3											
11-18	DS3 1.2 & 1.6 46mm OD strut base	G8204 R G8205 L	—	"SP4052" = 1.4 & 1.6 VTi 120 manual [EXC] 1.2 & 1.4 Hdi 70 with stop/start "SP4053" 1.4Hdi 70 with stop/start & 1.6 [EXC] 1.2 & 1.6VTi 120 manual)	PK150 / MK321A	⚙️ (47mm OD strut base)	61170	"SP4054"	—	—	○ ○
11-18	DS3 1.2 & 1.6 51mm OD strut base	G8206 R G8207 L	—	"SP4052" = 1.4 & 1.6 VTi 120 manual [EXC] 1.2 & 1.4 Hdi 70 with stop/start "SP4053" 1.4Hdi 70 with stop/start & 1.6 [EXC] 1.2 & 1.6VTi 120 manual)	PK150 / MK321A	⚙️ (51mm OD strut base)	61170	"SP4054"	—	—	○ ○
DS4											
11-16	DS4 1.6, 2.0	G8383 R G8384 L	742190SP R > 742191SP L	—	"PK124" / MK322	⚙️	62230	—	—	"PK131"	⊥ ○
DS5											
12-16	DS5 1.6, 2.0		—	—	/"MK196"			—	—	—	
Dispatch / Jumpy											
11-16	Dispatch Multispace Minibus & panel van	"G8167" R "G8168" L	—	—	"MK269R" (right) & "MK270L" (left)	⚙️	"V2517"	—	—	—	○ ○
Jumper / Relay											
11-18	Jumper Van (Check original front piston rod outer diameters, & original rear open and closed lengths for correct shock selection)	V4512 (Check piston rod outer diameter)	—	—	"PK285" / "MK308R" & "MK309L"	⚙️ (Rod outer diameter = 25mm)	V2130 (Check OE lengths)	—	—	—	⊖ ⊖ V2130 = Closed: 283mm, Open: 418mm
		V4513 (Check piston rod outer diameter)	—	—		⚙️ (Rod outer diameter = 28mm)	V2131 (Check OE lengths)	—	—	—	⊖ ⊖ V2131 = Closed: 315mm, Open: 476mm
							V2132 (Check OE lengths)	—	—	—	⊖ ⊖ V2132 = Closed: 293mm, Open: 444mm

Key

*	See important installation information on inside front cover
!	Excluding self-leveling suspension
"..."	Special order – phone 010 900 1850. 6-12 week waiting period

~	Imported
#	Internal bump stop
⊖	Steering damper

- It is recommended that all new shock absorbers are fitted in pairs
- Do not mix gas and non-gas units on the same axle
- **Bold** part numbers indicate heavy-duty shocks
- Underlined part numbers indicate parts not immediately available
- *Italic* part numbers followed by > indicate parts to be discontinued

Passenger and light commercial

Part number [alphabetical listing]

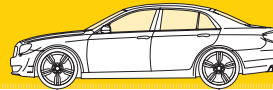

Year	Application	Front					Rear				
		Entry shocks	Premium shocks	Springs	Protection kits/ Mounting kits	Mounting information	Entry shocks	Premium shocks	Springs	Protection kits/ Mounting kits	Mounting information
CITROEN <i>continued</i>											
Xsara											
01-05	Xsara II	G8007 R G8008 L (1.4) / "G16422" R "G16423" L (1.6, 2.0 & 2.0d)	-	-	PK006 / "MK097"		42041	-	-		○ ○
Xsara Picasso											
01-07	Xsara Picasso MPV	G8007 R G8008 L	-	-	PK006 / "MK097"		43114	-	-		○ ○
CMC											
Amandla											
12-on	Amandla 2.2 15 seater minibus taxi		-	-	-			-	-		
Lifan											
12-14	Lifan sedan		-	-	-			-	-		
Plutus											
11-on	Plutus 2.2, 2.4 S/C & D/C LCV		-	-	-			-	-		
Ses'buyile											
12-on	Ses'buyile 16 seater minibus taxi		-	-	-			-	-		
DAEWOO											
Cielo											
95-98	Cielo	GT0117	-	-	PK004 / MK037	 INCL Centralsing Ring	GT1025 *7	-	-		⊥ ⊕
Espero											
96-98	Espero	GT0117	-	-	PK004 / MK037	 INCL Centralsing Ring	GT1025 *7	-	-		⊥ ⊕
Lanos											
98-03	Lanos T100	GT0117	-	-	PK004 / MK037	 INCL Centralsing Ring	GT1025 *7	-	-		⊥ ⊕
Matiz											
99-03	Matiz hatch M100	11377 R 11378 L	-	-	PK004 / "MK410"		R1643A	-	-		○ ○
Nubira											
97-03	Nubira I & II INCL S/W EXCL ABS (J100)	11744 R > 11745 L >	-	-	-	 This unit has no bracket for the ABS	11290 R > 11291 L >	-	-		
97-03	Nubira I & II INCL S/W & with ABS brakes (J100)	11456 R > 11457 L >	-	-	-		11290 R > 11291 L >	-	-		
Tacuma											
01-03	Tacuma MPV		-	-	PK004		"G43153"	-	-		○ ○
DAIHATSU											
Charade											
03-06	Charade / Mira (L250) / Cuore (L251)		-	-	-	 Check model code / OE#	"G1122"	-	-		○ ○
Cuore / Mira											
98-04	Cuore L700 & L701 gen 5 EXCL L710 AWD)		-	-	-		R3469	-	-	Check OE numbers	○ ○
03-08	Cuore L251 gen 6 EXCL L260 AWD)		-	-	-		"G1122"	-	-	Check OE numbers	○ ○

Key

*	See important installation information on inside front cover
!	Excluding self-levelling suspension
"..."	Special order - phone 010 900 1850. 6-12 week waiting period

~	Imported
#	Internal bump stop
⊕	Steering damper

- It is recommended that all new shock absorbers are fitted in pairs
- Do not mix gas and non-gas units on the same axle
- **Bold** part numbers indicate heavy-duty shocks
- Underlined part numbers indicate parts not immediately available
- *Italic* part numbers followed by > indicate parts to be discontinued

Passenger and light commercial

Part number [alphabetical listing]

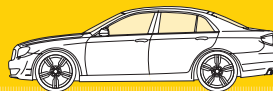

Year	Application	Front					Rear				
		Entry shocks	Premium shocks	Springs	Protection kits/ Mounting kits	Mounting information	Entry shocks	Premium shocks	Springs	Protection kits/ Mounting kits	Mounting information
DAIHATSU continued											
Feroza											
98-09	Feroza F300 4x4 (300 F310)	-	"D8465S"	-	-	⊥ ⊕	-	"D4442S"	-	-	⊥ ⊕
Grand Max											
10-16	Grand Max 1 ton drop side pick-up 1.5 (S402 - Toyota LiteAce)	-	-	-	-		-	-	-	-	
Materia											
07-13	Materia Minii MPV (M4...)	-	-	-	-		-	-	-	-	○ ○
Move/Grand Move											
98-01	Move L901	-	-	-	-		R3469	-	-	-	○ ○
98-02	Grand Move G301, G303	-	-	-	-		-	-	-	-	
Rocky											
98-09	Rocky 4x4 F73, F78, F98	-	"D5476" >	-	-	⊥ ⊕ No S/pan	-	"D8477" > "D8477S"	-	-	⊥ ⊕
Sirion / Storia / Boon											
98-Feb'05	Sirion hatch (M100 / M101) - Cross border = Storia / Toyota Duet	-	-	-	-		R3469	-	-	-	○ ○
March '05-10	Sirion 1.3 & 1.5 hatch 4x2, 300 4x4 (M300) - Cross border = Boon	G9505 >	-	-	-		150734R > "G1146"	-	-	-	○ ○ (Thailand)
11-early '16	Sirion 1.3 & 1.5 hatch gen 2 4x2, 300 4x4 (M600) - Cross border = Boon	G9505 >	-	-	-		150734R > "G1146"	-	-	-	○ ○ (Thailand)
Terios											
98-May'00	Terios 4x2 & 4x4 (J100) Generation One	-	D0001R / D0002L	-	-		-	D7639 > D7639S	-	-	○ ○
May'00-May'06	Terios 4x2 & 4x4 (J100) Generation One	-	D0001R / D0002L	-	-		-	D7011 > D7011S	-	-	○ ○
June'06-17	Terios 4x2 & 4x4 (J200 SWB 5 seater & J700 LWB 7 seater) Generation Two	-	D0308S (with a "flat" on the threads, 300 OE units with a flat on the "shoulder" of the rod below the threads)	-	-	 300 models with Stabiliser bars or a "flat" area below the threads: OE# 48520BZ150A, 48510B4011, 48510B4061	GT1069 - !	D7021S > !	-	-	○ ○
YRV											
01-07	YRV mini-MPV M2, 100 Turbo, 300 AWD	-	-	-	-		R3469	-	-	-	○ ○

For Daimler ... see Jaguar

For Nissan ... see Nissan

DATSUN

1200											
71-75	1200 Sedan (100 GX Sedan)	GT0401	-	-	-		-	-	-	-	⊥ ⊕
72-75	1200 GX Coupe	GT0401	-	-	-		-	-	-	-	⊥ ○
120 / 140 / 160 / Sunny											
75-80	120Y & 140 SDX Sedan - 12" Wheels (300 160 & 13" Wheels)	GT0401	-	-	-		-	-	-	-	⊥ ⊕
75-80	140Y & 160Y S/Wagon	-	-	-	-		GT2006	-	-	-	○ ○
75-80	140GX, 160GX, 140Z & 160Z Coupe	-	-	-	-		42022 (Firm ride)	-	-	-	⊥ ○
120Y / B120 / B140											
71-79	B120 LDV, 120Y LDV	GT0401	-	-	-		GT2006	-	-	-	○ ○
76-83	120Y Panel Van (12" wheels)	GT0401	-	-	-		GT2006	-	-	-	○ ○
80-08	B140 1400 LDV & Panel Van	GT0401	-	-	-	 (EXCL slimline units)	GT2006	-	-	-	○ ○

Key

*	See important installation information on inside front cover
!	Excluding self-levelling suspension
"..."	Special order - phone 010 900 1850. 6-12 week waiting period

~	Imported
#	Internal bump stop
⊕	Steering damper

- It is recommended that all new shock absorbers are fitted in pairs
- Do not mix gas and non-gas units on the same axle
- **Bold** part numbers indicate heavy-duty shocks
- Underlined part numbers indicate parts not immediately available
- *Italic* part numbers followed by > indicate parts to be discontinued

Passenger and light commercial

Part number [alphabetical listing]

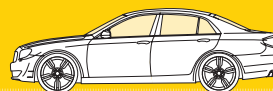

Year	Application	Front					Rear				
		Entry shocks	Premium shocks	Springs	Protection kits/ Mounting kits	Mounting information	Entry shocks	Premium shocks	Springs	Protection kits/ Mounting kits	Mounting information
DATSUN continued											
160J / 180J Stanza											
78-84	160J & 180J Stanza Sedan (S/Wagon)	-	-	-	-		GT2086 >	-	-	-	\perp \ominus
240 / 260 / 300 C											
71-78	240C, 260C, & 300C	-	-	-	-	\perp \ominus	GT2024	-	-	-	\circ \circ
620 / 680 / 720 One ton											
65-80	1200, 1300, 1500, 1600, 620, 680 LDV (520, 521, 620 series)	M4462	-	-	-	\perp \ominus	V1029 > D4437S	AU161712 >	-	-	\circ T
80-87	720 Series, 1800, 2200 LDV	M4462	-	-	-	\perp \ominus	M4441 / GT2006	-	-	-	\circ \circ
For Datsun E20 ... see Nissan E20											
Go											
2015-22	Go hatch (Go+ (7 seater))	G9028 R G9029 L	-	-	-		G1282	-	-	-	\circ \circ
For Datsun Skyline ... see Nissan Skyline											
DODGE											
Caliber											
06-12	Caliber 1.8, 2.0 & 2.4 cross-over hatch	-	72367ST R 72368ST L	-	MK = 907994MM		-	72401ST	-	-	\perp \ominus S/pan unit
Journey											
08-11	Journey MPV (JC49) self leveling susp	-	72509ST R 72510ST L	-	-		-	72511ST !	-	-	\perp \ominus S/pan unit (64mm longer than later model open)
11-17	Journey MPV (JC49 facelift) self leveling susp	-	72509ST R 72510ST L	-	-		-	72896ST !	-	-	\perp \ominus S/pan unit (64mm shorter than earlier model open)
Nitro											
07-11	Nitro SUV AWD	-	71577ST	-	MK = 905902MM (right) & 905903 (left)		-	37203	-	-	\ominus \ominus
Ram											
03-07	Ram 2500 D 3/4 ton 4x2	-	-	-	-	\perp \ominus	"911222MM" >	-	-	-	\ominus \ominus
03-06	Ram 2500 W 3/4 ton 4x4 Power wagon)	-	-	-	-	\perp \ominus	"911222MM" >	-	-	-	\ominus \ominus
FIAT-PASSENGER											
124											
69-79	124 Sedan	"R2559"	-	-	-	\perp \circ	"R3274"	-	-	-	\perp \circ
69-79	124 S/Wagon	"R2559"	-	-	-	\perp \circ	"G22563"	-	-	-	\circ \circ
128											
71-84	128 All	"R11003"	-	-	-		"R11004"	-	-	-	
131											
74-84	131 All	"R11002"	-	-	-		"R3274"	-	-	-	\perp \circ
500											
08-on	500 0.9, 1.2, 1.4 (3 door) Abarth / sport susp, "L" & "X" models (312)	G7305 R G7306 L	-	-	PK148 / MK095		G1083	-	-	PK332	\circ \circ (Rear PK332 is bump rubber only)
500L											
14-18	500L 1.4, 1.6 (5 door) Std 500 models, "X" models, Abarth / sport susp (351 & 352)	G8381 R G8382 L	742222SP R > 742223SP L >	-	PK148 / "MK451"		G1345	-	-	PK332	\perp \ominus (Rear PK332 is bump rubber only)

Key

*	See important installation information on inside front cover
!	Excluding self-levelling suspension
"..."	Special order - phone 010 900 1850. 6-12 week waiting period

~	Imported
#	Internal bump stop
	Steering damper

- It is recommended that all new shock absorbers are fitted in pairs
- Do not mix gas and non-gas units on the same axle
- **Bold** part numbers indicate heavy-duty shocks
- Underlined part numbers indicate parts not immediately available
- *Italic* part numbers followed by > indicate parts to be discontinued

Passenger and light commercial

Part number [alphabetical listing]

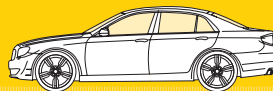

Year	Application	Front					Rear				
		Entry shocks	Premium shocks	Springs	Protection kits/ Mounting kits	Mounting information	Entry shocks	Premium shocks	Springs	Protection kits/ Mounting kits	Mounting information
FIAT-PASSENGER continued											
500X											
15-on	500X 1.4, 1.6 5 door Cross over SUV (FWD)	—	742290SP R 742291SP L	—	PK426 /		—	742292SP R 742293SP L	—	PK427 / PK332 /	 (Rear PK332 is bump rubber only)
15-on	500X 1.4, 1.6 5 door Cross over SUV (AWD)	—	742296SP R 742297SP L	—	PK426 /		—	742294SP R 742295SP L	—	PK427 / PK332 /	 (Rear PK332 is bump rubber only)
Bravo											
07-15	Bravo (198 generation II) 1.4, 1.9 (EXC sport susp)	G8110	—	—	"PK334" / "MK302"		23963	—	—	"PK108"	
Croma											
06-09	Croma (generation II)	"16475" R "16476" L	—	—	PK164 / "MK208" (mount) & "MK342" (bearings only)		"43124"	—	—	—	
Doblo											
03-early 10	Doblo 1.3, 1.4 & 1.9 Cargo panel Van (119) (223)	"16470"	—	—	PK109 / MK374R & MK375L		"25506"	—	—	—	
10-22	Doblo 1.6 Panorama MPV (152) & Cargo panel van (263)	"G8208" R "G8209" L	—	—	"MK313R" & "MK314L"		"G1171"	—	—	—	
Ducato											
02- June'06	Ducato 10, 14 Van 2.3JTD, 2.8JTD - 1.0 ton & 1.5 ton Gen 2	V4501	—	—	"PK074" / "MK308R" & "MK309L"		"V2506" (1 ton)	—	—	—	 OE#1303682080
							V2507 (1.5 ton)	—	—	—	 OE#1312314080 or 1314562081
July'06-on	Ducato SWB & LWB Van & Minibus (Q11, Q15, Q17, Q20) Gen 3	V4512	—	—	"PK285" / "MK308R" & "MK309L"	 (Rod outer diameter = 25mm)	V2130 ! (Check OE lengths)	—	—	"PK457"	 V2130 = Closed: 283mm, Open: 418mm
	(Check rear open and closed lengths, and front rod outer diameter)	V4513	—	—	"PK285" / "MK308R" & "MK309L"	 (Rod outer diameter = 28mm)	V2131 ! (Check OE lengths)	—	—	"PK457"	 V2131 = Closed: 315mm, Open: 476mm
							V2132 ! (Check OE lengths)	—	—	"PK457"	 V2132 = Closed: 293mm, Open: 444mm
Fiorino											
13-21	Fiorino cargo panel van (327)	"G8107" R "G8108" L	—	—	PK140 / "MK313R" & "MK314L"		"G1090A"	—	—	"PK335"	
Fullback											
16-on	Fiat Fullback LCV 4x2	—	—	—	—	—	—	—	—	—	—
16-on	Fiat Fullback LCV ALL 4x2 raised body & 4x4	"AU360921"	RS55801B	—	—		AU160922	—	—	—	
Linea											
09-14	Linea sedan 1.4 8v (304 T-Jet)	G8063 R G8064 L	—	—	PK140 / "MK313R" & "MK314L"		G1249	—	—	—	
Multipia											
03-10	Multipia MPV 1.6, 1.9JTD (304 Bi-power)	G8325	—	—	"PK288" / "MK048"		G1264	—	—	—	
Palio											
00-03	Palio hatch Type 1X MkI	16776	—	—	PK109 / MK374R & MK375L		23965	—	—	PK110	
03-10	Palio II hatch Type 2H MkIV	94155A	—	—	MK374R & MK375L	 Smaller s/pan	23965	—	—	PK110	

Key

*	See important installation information on inside front cover
!	Excluding self-levelling suspension
"..."	Special order - phone 010 900 1850. 6-12 week waiting period

~	Imported
#	Internal bump stop
⊕	Steering damper

- It is recommended that all new shock absorbers are fitted in pairs
- Do not mix gas and non-gas units on the same axle
- **Bold** part numbers indicate heavy-duty shocks
- Underlined part numbers indicate parts not immediately available
- *Italic* part numbers followed by > indicate parts to be discontinued

Passenger and light commercial

Part number [alphabetical listing]

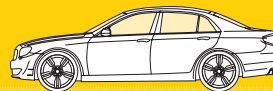

Year	Application	Front					Rear				
		Entry shocks	Premium shocks	Springs	Protection kits/ Mounting kits	Mounting information	Entry shocks	Premium shocks	Springs	Protection kits/ Mounting kits	Mounting information
FIAT-PASSENGER continued											
Palio											
00-02	Palio Weekend S/Wagon Type PY & 1Y	16776	—	—	PK109 / MK374R & MK375L		<i>GT1031 > / 25485 > / G1264</i>	—	—	—	⊕ ⊕
02-10	Palio II Weekend S/Wagon Type ZG & 2K 1.4 [EXCL] 2K 1.6	"G16356"	—	—	PK109 / MK374R & MK375L	 Smaller s/pan	<i>GT1031 > / 25485 > / G1264</i>	—	—	—	⊕ ⊕
Palio											
01-10	Palio Expresso panel Van	94155A	—	—	MK374R & MK375L		23965	—	—	PK110	⊥ ⊕
Panda											
04-10	Panda 1.2, 1.3 [EXCL] AWD & 1.4 100HP (169)	16381 R 16382 L	—	—	PK148 / MK095		23977	—	—	PK332	⊕ ⊕
04-10	Panda 1.3 Climbing AWD (169)	"G8174" R "G8175" L	—	—			"G1121"	—	—		⊕ ⊕
11-22	Panda 0.9, 1.2 [EXCL] AWD & 1.4 100HP (319) mk4	G8282 R G8283 L	—	—	"PK428" / MK095		G2510	—	—	"PK455"	⊕ ⊕
11-22	Panda 0.9, 1.2 Climbing / Cross AWD [EXCL] 1.4 100HP (319) mk4	"G8284" R "G8285" L	—	—	"PK428" / MK095		"G2508"	—	—	"PK455"	⊕ ⊕
Punto											
04-Feb'12	Punto 1.2, 1.3 JTD, 1.4 Hatch (MkII) (188)	16306	—	—	"PK161" / MK095	 No bracket under the springseat. (Check rear shock mounting - eye/eye)	23473	—	—	—	⊕ ⊕
04-05	Punto 1.8 HGT 1.6v 3 door Hatch, plus 1.4 Sport Susp (MkII) (188)	"16417"	—	—	"PK161" / MK095		23473	—	—	—	⊕ ⊕
March '12-16	Punto 1.2, 1.3 JTD, 1.4 Hatch (199) [EXCL] sport susp [EXCL] turbo	G8063 R G8064 L	—	—	PK140 / MK305	 Bracket under the springseat. (Check rear shock - stud/eye mountings)	G1037	—	—	PK018 / MK384R & MK385L	⊥ ⊕
Grand Punto											
06-16	Grand Punto 1.2, 1.3, 1.4 & 1.9 (199)	G8063 R G8064 L	—	—	PK140 / MK305	 Bracket under the springseat	G1037	—	—	PK018 / MK384R & MK385L	⊥ ⊕
Qubo											
13-17	Qubo mini MPV	"G8107" R "G8108" L	—	—	PK140 / "MK313R" & "MK314L"		"G1090A"	—	—	"PK335"	⊕ ⊕
Scudo											
08-16	Scudo 7 seater (gen 2)	"G8167" R "G8168" L	—	—	"MK269R" (right) & "MK270L" (left)		"V2517"	—	—	—	⊕ ⊕
Seicento											
01-06	Seicento 1100	10053	—	—	"PK056" / "MK049"		R3472	—	—	"PK126"	⊕ ⊕
Siena 178											
00-02	Siena sedan Type 2A	16776	—	—	PK109 / MK374R & MK375L		23965	—	—	PK110	⊥ ⊕
02-10	Siena II sedan	94155A	—	—	MK374R & MK375L	 Smaller s/pan	23965	—	—	PK110	⊥ ⊕
Stilo											
03-10	Stilo 1.6 Hatch	16454	<i>E7001 ></i>	—	"PK093" / "MK302"		23963	—	—	"PK108"	⊥ ⊕
03-10	Stilo 1.8, 1.9 JTD Hatch	16455	—	—	"PK093" / "MK302"		23963	—	—	"PK108"	⊥ ⊕
03-10	Stilo 2.4 Abarth Hatch	"G8320"	—	—	"PK093" / "MK302"		23963	—	—	"PK108"	⊥ ⊕

Key

*	See important installation information on inside front cover
!	Excluding self-levelling suspension
"..."	Special order - phone 010 900 1850. 6-12 week waiting period

~	Imported
#	Internal bump stop
⊕	Steering damper

- It is recommended that all new shock absorbers are fitted in pairs
- Do not mix gas and non-gas units on the same axle
- **Bold** part numbers indicate heavy-duty shocks
- Underlined part numbers indicate parts not immediately available
- *Italic* part numbers followed by > indicate parts to be discontinued

Passenger and light commercial

Part number [alphabetical listing]

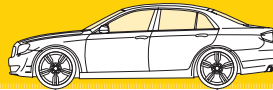

Year	Application	Front					Rear				
		Entry shocks	Premium shocks	Springs	Protection kits/ Mounting kits	Mounting information	Entry shocks	Premium shocks	Springs	Protection kits/ Mounting kits	Mounting information
FIAT-PASSENGER <i>continued</i>											
Stilo											
03-10	Stilo 1.6 Multi Wagon	16454	E7001 >	-	"PK093" / "MK302"		"G1263"	-	-	-	
03-10	Stilo 1.9 JTD Multi Wagon	16455	-	-	"PK093" / "MK302"		"G1263"	-	-	-	
Strada											
05-16	Strada 3/4 ton LDV Pickup: 1.2, 1.4, 1.6, 1.7TD	94176A	-	-	MK374R / MK375L		379024SP	-	-	-	
Tipo											
16-on	Tipo 1.4 & 1.6 (356)	G8623 R G8624 I	-	PK140 / MK305 (bearings)	-		G2244	-	-	-	
Ulysse											
94-Aug'97	Ulysse MPV	"V4201"	-	-	"PK122" / "MK269R" & "MK270L"		"V5006"	-	-	-	
Sept'97-02	Ulysse MPV	"V4201"	-	-	"PK122" / "MK269R" & "MK270L"		"V2510"	-	-	-	
02-06	Ulysse MPV	"G8601" R "G8602" I	-	-	"MK269R" & "MK270L"		"G2247"	-	-	-	
Uno											
90-'09	Uno (raised body "Way" version from Brazil)	G7233	-	SP0145 (Turbo & 1.4 57kwPacer)	PK013 / MK030		GT1026 *7	-	SP0539 (Turbo & 1.4 57kwPacer)	MK125	 models with btm U bracket or strut

FORD											
B-Max											
15-17	B-Max Mini MPV 1.0 (JK)	G8288 R G8289 I	-	PK291 /	-		G1228	-	-	PK078 / MK364	
Bantam											
83-86	Bantam LDV	G7236	-	-	PK013 (Bump rubber only)		GT2018	-	-	-	
87-93	Bantam LDV	G7230	-	-	PK013 (Bump rubber only)		GT2018	-	-	-	
94-Nov'02	Bantam LDV	G7252	-	-	PK058		GT2001	-	-	-	
Dec'02-11	Bantam LDV	G7207	-	-	PK022		GT2001	-	-	-	
Cortina											
71-Mid 83	Cortina Sedan & S/Wagon MKIII & MKIV + MKV S/Wagon (MKV sedan)	-	-	-	-		R1568	-	-	-	
Mid 80-83	Cortina Sedan (MKV)	-	-	-	-		GA2078 > *7	-	-	-	
Cortina											
71-Mid 78	Cortina LDV All (MKIII, MKIV)	-	-	-	-		-	-	-	-	
Mid 78-Mid 83	Cortina LDV All (MKIV)	-	-	-	-		GA2076 >	-	-	-	
Mid 83-86	Cortina One Tonner LDV (MKV)	-	-	-	-		GA2080 >	-	-	-	
Courier											
86-Jan'00	Courier All 4X2	GT2030 / M8058	-	-	-		GT2031 / M8059	-	-	-	
86-Jan'00	Courier All 4X4	M7366	RS999039 (Re-use bottom OE sleeve)	-	-		M7367	RS999321	-	-	
Ecosport											
13-on	EcoSport cross-over SUV 1.0T, 1.5, 1.5TDCi (Gen 2)	G8314 R G8315 I	-	-	PK291 / MK485 (bearings)	 (Tenneco IN)	G2525	-	-	/ MK364 (bearings)	 (Tenneco IN)

Key

*	See important installation information on inside front cover
!	Excluding self-levelling suspension
...	Special order - phone 010 900 1850. 6-12 week waiting period

~	Imported
#	Internal bump stop
	Steering damper

- It is recommended that all new shock absorbers are fitted in pairs
- Do not mix gas and non-gas units on the same axle
- **Bold** part numbers indicate heavy-duty shocks
- Underlined part numbers indicate parts not immediately available
- *Italic* part numbers followed by > indicate parts to be discontinued

Passenger and light commercial

Part number [alphabetical listing]

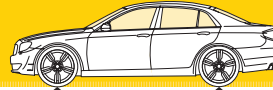

Year	Application	Front					Rear				
		Entry shocks	Premium shocks	Springs	Protection kits/ Mounting kits	Mounting information	Entry shocks	Premium shocks	Springs	Protection kits/ Mounting kits	Mounting information
FORD <i>continued</i>											
Escort											
Mid 81-86	Escort FWD	G77236	—	—	PK013 (Bump rubber only)		—	—	—	—	
95-99	Escort	G77241 >	—	1.3 & 1.4 = "SP3257" 1.6 & 1.8 = "SP0039"	PK022 / "MK053" (bump rubber only)		G71017 > *14	—	1.6 & 1.8 = "SP0520" 1.3 & 1.4)	PK018 / "MK127"	
95-99	Escort S/Wagon	G77241 >	—	1.3 & 1.4 = "SP3257" 1.6 & 1.8 = "SP0039"	PK022 / "MK053" (bump rubber only)		—	—	—	—	
Everest											
09-Sept '15	Everest SUV 4x2 & 4x4 (U268)	M7366	RS999039 (Re-use bottom OE sleeve)	—	—		M7367	RS999321	—	—	
Oct '15-'22	Everest SUV 4x2 & 4x4 (U375) facelift			—	—				—	—	
23-on	Everest SUV 4x2 & 4x4 (U704)			—	—				—	—	
Explorer											
91-94	Explorer	—	—	—	—		—	"37035" >	—	—	
95-01	Explorer 4x4 Auto ride height control - special order)	—	—	—	—		—	"37035" 1 >	—	—	
F100 / F250											
65-67	F100 & F250 (4x2)	D4470 > D4470S	—	—	—		M8038	—	—	—	
67-69	F100 & F250 (4x2)	M8034 >	—	—	—		M8038	—	—	—	
70-81	F100 & F250 (4x2)	M8034 >	—	—	—		—	—	—	—	
99-07	F250 (4x4) (check front mountings)	911195MM	—	—	—		911196MM (x4)	—	—	—	
05-09	F250 (4x2)	"911173MM" >	—	—	—		—	—	—	—	
05-09	F250 (4x4) (check front mountings)	911266MM	—	—	—		911267MM	RS999254 >	—	—	
F350											
75-81	F350	M8034 >	—	—	—		—	—	—	—	
Falcon / Fairlane / Fairmont											
69-76	Old Fairlane & Fairmont	—	—	—	—		G72007 >	—	—	—	
96-98	Falcon Gli, Futura, Fairmont EF, EH, EL XR6	AU350288 > AU350289 >	—	—	—		AU150202 >	—	—	—	
96-98	Falcon Futura Fairmont S/Wagon EF, EH, EL (Std. susp.)	AU350288 > AU350289 >	—	—	—		—	—	—	—	
end 98-01	Falcon Futura & Fairmont sedan AU IRS XR6	AU350406 >	AU370406 >	—	—		AU150202 >	—	—	—	
end 98-01	Falcon XR6 AU (Lowered Susp, IRS) Check rear shock type	AU350406 >	AU374406 >	—	—		—	—	—	—	
end 98-01	Falcon Futura & Fairmont S/Wagon AU (Std. Susp IRS)	AU350406 >	AU370406 >	—	—		—	—	—	—	

Key

*	See important installation information on inside front cover
!	Excluding self-levelling suspension
"..."	Special order - phone 010 900 1850. 6-12 week waiting period

~	Imported
#	Internal bump stop
	Steering damper

- It is recommended that all new shock absorbers are fitted in pairs
- Do not mix gas and non-gas units on the same axle
- **Bold** part numbers indicate heavy-duty shocks
- Underlined part numbers indicate parts not immediately available
- *Italic* part numbers followed by > indicate parts to be discontinued

Passenger and light commercial

Part number [alphabetical listing]



Year	Application	Front					Rear				
		Entry shocks	Premium shocks	Springs	Protection kits/ Mounting kits	Mounting information	Entry shocks	Premium shocks	Springs	Protection kits/ Mounting kits	Mounting information
FORD continued											
Falcon / Fairlane / Fairmont continued											
end 01-Sept'02	Falcon Futura & Fairmont sedan AU II (Std. Susp, EXCL IRS & XR6)	AU350447 >	-	-	-		AU150202 >	-	-	-	
end 01-Sept'02	Falcon Futura & Fairmont S/Wagon AU II (EXCL IRS)	AU350447 >	-	-	-		-	-	-		
Oct'02-08	Falcon Sedan (EXCL XR6)	AU350507 >	-	-	-		AU150509 >	-	-		
Oct'02-08	Falcon Sedan XR6 (EXCL OE lowered)	AU350507 >	-	-	-		-	-	-		
Oct'02-08	Falcon S/Wagon	AU350507 >	-	-	-		-	-	-		
Fiesta											
97-Mid 99	Fiesta (EXCL Power steering) Mk4 (JA, JB)	GT7206 *11	-	SP0256	PK022 / MK055 (EXCL bearings)		GT1018	-	SP0509 > SE0509	PK018 / MK126	
Mid 99-03	Fiesta (EXCL RSi) Mk4 facelift (JA, JB)	GT7206 *11	-	SP0256	PK022 / MK055 (EXCL bearings)		GT1004 *14	-	SP0509 > SE0509	PK018 / MK126	
Mid 99-03	Fiesta 3 door 1.6 RSi & ST sport with power steering Mk4 facelift (JA, JB)	G16262 > 16226	-	-	PK022 / MK055 (EXCL bearings)		-	-	-	MK126	
04-Oct'08	Fiesta Sedan & Hatch Mk 5 JH, JD (EXCL 2.0ST (EXCL 2.5 ST or RS))	G16385 R G16386 L	-	SP2461 > SE2461	PK168 / MK183 (EXCL bearings)	 Oval spring	43125	-	SP1156 > SE1156	PK078 / MK364	
Nov'08-Oct'12	Fiesta Sedan & Hatch Mk 6 CB1, CCN (EXCL 1.6 ST)	G7303 R G7304 L	-	"SP4294" = 1.0 "SP3787" = 1.4 (OE paint flash green+red, or violet+red) "SP3833" = 1.4 (OE paint flash green+orange) TBA = 1.5 Tdci	PK291 / MK317 (EXCL bearing) or MK485 (EXCL bearings)	 (longer than facelift model) EXCL OE# C1BC18045PB, C1BC18045C01, AV5918045B-GAV5918K001AG & DN3434700R where the s/pan is different	44001	-	SP3788	PK078 / MK364	
Nov 12-17	Fiesta Sedan & Hatch Mk 6 facelift (EXCL ST)	G8288 R G8289 L	-	SP4227 (1,0 manual) SP4228 (1,0 auto, 1.5, 1.6)	PK291 / MK485 (EXCL bearings)	 (Shorter than earlier model)	G1228	-	SP3788	PK078 / MK364	
17-22	Fiesta Sedan & Hatch Mk 7 HJ, HF	G8631 R G8632 L	-	-	PK467 / MK478 (EXCL bearings)		G44002	-	-	PK078 / MK364	
Figo											
10-Nov 15	Figo Hatch 1.4 gen 1	G16385 R G16386 L	-	SP2461 > SE2461	PK168 / MK183	 Oval spring	43125	-	SP1156 > SE1156	PK078 / MK364	
Dec 15-18	Figo Hatch & sedan 1.5 gen 2 (EXCL Freestyle Cross)	G7303 R G7304 L	-	-	PK291 / MK317 (EXCL bearing) or MK485 (EXCL bearings)	 (Check OE #'s)	G1228	-	-	PK078 / MK364	
18-21	Figo Hatch & sedan gen 3	G8288 R G8289 L	-	-	PK291 / MK485 (EXCL bearings)	 (Check OE #'s)	G1228	-	-	PK078 / MK364	
Focus											
03-Oct'04	Focus 1.6 Hatch & Sedan Mk1 DAW (EXCL 2.0 & ST170)	G16275 R G16276 L	-	SP2457 > SE2457	PK084 / MK114 (EXCL bearings)		23904	-	SP2453 > SE2453	PK102	
00-Oct'04	Focus 2.0 & ST170 Hatch and Sedan Mk1	16282 R 16283 L	-	-	PK084 / MK114 (EXCL bearings)		23904	-	-	PK102	

Key

*	See important installation information on inside front cover
!	Excluding self-leveling suspension
...	Special order - phone 010 900 1850. 6-12 week waiting period

~	Imported
#	Internal bump stop
⊕	Steering damper

- It is recommended that all new shock absorbers are fitted in pairs
- Do not mix gas and non-gas units on the same axle
- **Bold** part numbers indicate heavy-duty shocks
- Underlined part numbers indicate parts not immediately available
- *Italic* part numbers followed by > indicate parts to be discontinued

Passenger and light commercial

Part number [alphabetical listing]

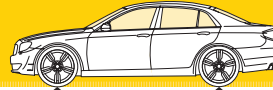

Year	Application	Front					Rear				
		Entry shocks	Premium shocks	Springs	Protection kits/ Mounting kits	Mounting information	Entry shocks	Premium shocks	Springs	Protection kits/ Mounting kits	Mounting information
FORD <i>continued</i>											
Focus II											
Nov'04- July 11	Focus 1.6, 1.6Si, 1.8TDCi, 2.0, 2.0Si, 2.0TDCi & TDCi Si, INC1 2.5 ST front only, Hatch and Sedan MkII DA, DP (EXC1 2.5 ST rear & RS)	G8801 R G8802 L	742080SP R > 742081SP L >	1.6 = SP3493 > SE3493 2.0 manual = SP3494 > SE3494 2.0 auto, 1.8TDCi, 2.0TDCi = SP3495 > SE3495	PK156 / MK282 (INC1 bearings)		23988	376234SP >	SP3491 > SE3491	PK174 / MK202 (bearing only) + MK394 (mounting)	 EXC1 2.5 ST)
Nov'04- July 11	Focus hatch MkII 2.5 ST & RS only	—	—	—	/ MK282 (INC1 bearings)		—	—	—	PK174 / MK202 (bearing only) + MK394 (mounting)	
Focus III											
Aug'11-15	Focus 1.0, 1.5, 1.6, 2.0Si, 2.0TDCi & TDCi Si, INC1 2.0ST front only, Hatch and Sedan MkIII C346 (EXC1 2.0ST rear, RS, & facelift models)	G8171 R G8172 L	725222ST R 725233ST L	1.0 = TBA 1.5 = TBA 1.6 = SP3900	PK156 / MK282 (INC1 bearings)		23988	376234SP >	1.0 & 1.5 (EXC1 Tdc) & 1.6 = SP3902	PK174 / MK202 (bearing only) & MK394 (mounting)	 EXC1 2.0 ST)
Aug'11-15	Focus hatch MkIII 2.3RS AWD only	—	—	—	PK399 /		—	—	—	—	
15-early18	Focus (facelift) 1.0, 1.5, 1.6, 2.0Si, 2.0TDCi, TDCi Si, INC1 2.0ST front only, Hatch and Sedan MkIII C346 facelift (EXC1 2.0 ST rear & RS)	—	742298SP R 742299SP L	—	PK399 / MK282 (INC1 bearings)	OE#'s BV6118045LAB, BV6118045LBB, BV6118045LCB, BV6118045LEA, BV6118045LEB, KV6C18045LA plus more	23988	376234SP >	1.0 & 1.5 (EXC1 Tdc) & 1.6 = SP3902	PK174 / MK202 (bearing only) & MK394 (mounting)	 EXC1 2.0 ST)
15-early18	Focus hatch MkIII facelift 2.0ST (I & 3) & 2.3RS only	—	—	—	PK399 /		—	—	—	—	
Focus IV											
early18-22	Focus 1.0, 1.5 Hatch and Sedan MkIV C519 HN (EXC1 ST & RS)	—	—	—	—	—	—	—	—	—	—
early18-22	Focus hatch MkIV 2.0ST (I & 3) & 2.3ST only	—	—	—	—	—	—	—	—	—	—
Fusion											
15-17	Fusion sedan (gen2)	—	72638ST >	—	—		—	5667ST >	—	—	
Husky											
85-98	Husky Minibus, LDV, Panelvan	M8043 >	—	—	—		M4441 / GT2006	—	—	—	
Ikon											
00-06	Ikon sedan All	GT7206 *11	—	SP0256	PK022 / MK055 (INC1 bearings)		GT1004	—	SP0509 > SE0509	PK018 / MK126	 S/pan unit (Use two spacer washers on either side of the eye mount to prevent movement if needed)
07-15	Ikon sedan All	G16385 R G16386 L	—	SP2461 > SE2461	PK168 / MK183		43125	—	SP1156 > SE1156	PK078 / MK364	 No s/pan
Ka											
05-09	Ka 1.3 Hatch	"G7301" R "G7302" L	—	—	"PK097" / MK055 (INC1 bearings)		"23935"	—	—	MK126	
09-10	Ka 1.3 Hatch	G7305 R G7306 L	—	—	PK148 / MK095		G1083	—	—	PK332	

Key

*	See important installation information on inside front cover
!	Excluding self-levelling suspension
"..."	Special order – phone 010 900 1850, 6-12 week waiting period

~	Imported
#	Internal bump stop
	Steering damper

- It is recommended that all new shock absorbers are fitted in pairs
- Do not mix gas and non-gas units on the same axle
- **Bold** part numbers indicate heavy-duty shocks
- Underlined part numbers indicate parts not immediately available
- *Italic* part numbers followed by > indicate parts to be discontinued

Passenger and light commercial

Part number [alphabetical listing]

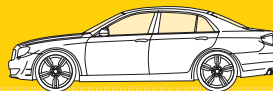

Year	Application	Front					Rear					
		Entry shocks	Premium shocks	Springs	Protection kits/ Mounting kits	Mounting information	Entry shocks	Premium shocks	Springs	Protection kits/ Mounting kits	Mounting information	
FORD continued												
Kuga												
11-12	Kuga 4x2 & 4x4 SUV (gen 1) C394	—	742196SP R 742197SP L	—	PK156 / MK282		—	376113SP	—	PK174		
13-19	Kuga 4x2 & 4x4 SUV (gen 2) DM2, C520	G8807 R G8808 L OR G8809 R G8810 L	—	(Available as a special order – dependant on engine size & drive)	PK444 / MK282 (inc bearings)	Check below diagram for s/pan differences (G8809/10 OE numbers = CV6118045DAB, DBB, DCB & CV6118K-001DAB, DBB, DCB)		G1227	—	"SP4234" = 1,5 & 2,0 4x2 & 4x4	PK443 / MK394 R (inc bearings)	
Laser / Meteor												
85-91	Laser & Meteor All (KC, KE)	GT7228	—	—	PK058	Re-use OE b/ hose brackets	GT7229	—	SP0433	PK018		
92-02	Laser & Meteor All EX Tracer (KF, KH)	GT7251	—	—	PK058	Re-use OE b/ hose brackets	GT7229	—	SP0433	PK018		
Mondeo												
98-Sept'01	Mondeo 1.8, 2.0 & 2.5 Si sedan	"16721"	—	—	"PK059" / "MK015"		"G16672"	—	—	"PK061" / "MK128"		
98-Sept'01	Mondeo 2.0 S/Wagon	"16721"	—	—	"PK059" / "MK015"		"G52020" !	—	—	—		
Sept'01-07	Mondeo Sedan & Coupe EX 18" Wheels & Sport susp	"16430"	—	—	PK098 / MK151		"16431"	"742098SP" >	—	"PK099"	EX 18" wheels	
Sept'01-07	Mondeo S/Wagon	"16430"	—	—	PK098 / MK151		"43120" !	"376160SP" > !	—	—		
Puma												
23-on	Puma 1,0T SUV	—	—	—	—	—	—	—	—	—	—	
Ranchero												
69-76	Old Ranchero	—	—	—	—		GT2007 >	—	—	—		
96-Mid 99	Ranchero EX XR6	AU350288 > R AU350289 L >	—	—	—		—	—	—	—		
96-Mid 99	Ranchero XR6 (XH) lowered	"AU350585" R > "AU350584" L >	—	—	—		"AU153132" >	—	—	—		
Mid 99-April'00	Ranchero All AUI EX XR6	AU350406	—	—	—		—	—	—	—		
May'00-02	Ranchero All AUII & AUIII EX XR6 (lowered)	"AU350447" >	—	—	—		—	—	—	—		
02-08	Ranchero All BA	"AU350507" >	—	—	—		—	—	—	—		
Ranger												
Feb'00-June'07	Ranger 4x2 EX Hi-Trail	GT2030 / M8058	—	—	—		GT2031 / M8059	—	—	—		
Feb'00-June'07	Ranger 4x4 & 4x2 Hi-Trail raised body	M7366	RS999039 (Re-use bottom OE sleeve)	—	—		M7367	RS999321	—	—		
July'07-11	Ranger 4x2 EX Hi-Trail	GT2030 / M8058	—	—	—		GT2112 / M8073	—	—	—	(top ID 20mm, btm ID 16mm)	

Key

*	See important installation information on inside front cover
!	Excluding self-levelling suspension
"..."	Special order – phone 010 900 1850. 6-12 week waiting period

~	Imported
#	Internal bump stop
⊕	Steering damper

- It is recommended that all new shock absorbers are fitted in pairs
- Do not mix gas and non-gas units on the same axle
- **Bold** part numbers indicate heavy-duty shocks
- Underlined part numbers indicate parts not immediately available
- *Italic* part numbers followed by > indicate parts to be discontinued

Passenger and light commercial

Part number [alphabetical listing]

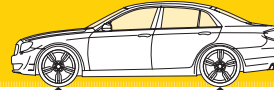

Year	Application	Front					Rear				
		Entry shocks	Premium shocks	Springs	Protection kits/ Mounting kits	Mounting information	Entry shocks	Premium shocks	Springs	Protection kits/ Mounting kits	Mounting information
FORD continued											
Ranger continued											
July'07-11	Ranger 4x4 & 4x2 Hi-Trail raised body	M7366	RS999039 (Re-use bottom OE sleeve)	-	-	⊥ ⊕	M7367	RS999321	-	-	⊕ ⊕ (top ID 20mm, btm ID 12mm)
end 11-19	Ranger 4x2 3.0i Hi-Trail) T6	M8083	-	-	-	⊥ ⊕ S/pan unit	M8085	-	-	-	⊕ ⊕
end 11-19	Ranger 4x4 & 4x2 Hi-Trail raised body T6 3.0i Raptor)	M8086	RS999778	SP4295	-	⊥ ⊕ S/pan unit	M8087	RS55020	-	-	⊕ ⊕
	Raised		RS55778B raised 38mm	"RS40004" Coil (30mm lift)	-	(Raised 38mm - From Australia / No top rubbers supplied - use OE rubbers)		RS55020A raised 38mm	"RS44024" Leaf (40mm lift) + "RS40041" U bolt kit	-	(Raised 38mm - From Australia)
	Steering Damper ⊕	SC2921 ⊕				⊕ ⊕ (steering damper)					
mid 19-22	Ranger 4x2 3.0i Hi-Trail) T6	M8099	-	-	-	⊥ ⊕ S/pan unit / Top stud OD 12mm, btm eye ID 20mm	M8085	-	-	-	⊕ ⊕
mid 19-22	Ranger 4x4 & 4x2 Hi-Trail raised body T6 3.0i Raptor)	M8101	RS55752			⊥ ⊕ S/pan unit OE# JB3C18045EBC (ME5332104) / OES # JB3Z18124B (ME5332102) Top stud OD 12mm, btm eye ID 20mm	M8087	RS55020	-	-	⊕ ⊕
	Raised	-	RS55752B raised 38mm	"RS40085" Coil (40mm lift)			-	RS55020A raised 38mm	"RS44024" Leaf (40mm lift) + "RS40041" U bolt kit		(Raised 38mm - From Australia)
	Steering Damper ⊕	SC2921 ⊕				⊕ ⊕ (steering damper)					
Sierra / Sapphire											
Mid 83-93	Sierra & Sapphire Sedan 3.0i XR8 & S/W	-	-	-	PK008 /	⊕	R2644 >	-	-	-	⊕ ⊕
Spectron											
91-03	Spectron 16 Seater Minibus & Panelvan	GT2023	-	-	-	⊥ ⊕	GT2024	-	-	-	⊕ ⊕
Telstar											
93-99	Telstar Sedan & TX5	GT8028 R GT8029 L	-	-	-	⊕	GT8030	-	-	-	⊕
Territory											
05-Sept'07	Territory 4x2 RWD SUV (SX, SY)	AU350660 R > AU350661 L >	744390SP R 744391SP L	-	-	⊕ Higher s/pan height 407mm (Btm U bracket)	AU150537	-	-	-	⊕ ⊕
05-Sept'07	Territory 4x4 SUV (SX, SY)	AU350659 >	-	-	-	⊕	AU150537	-	-	-	⊕ ⊕
Oct'07-09	Territory 4x2 RWD SUV (SY1)	-	-	-	-	⊕ Lower s/pan height 368mm (Btm U bracket)	AU150537	-	-	-	⊕ ⊕
Oct'07-09	Territory 4x4 SUV (SY1)	"AU350601" >	-	-	-	⊕	AU150537	-	-	-	⊕ ⊕
Tourneo / Transit Connect											
13-23	Tourneo Connect 5 & 7 seater minivan & Transit Connect compact minivan (gen 2 - V408, P65, P70, P80) FWD	-	72787ST R > 72788ST L > 742298SP R 742299SP L	-	-	⊕	-	37345ST !	-	-	⊕ ⊕ 3.0i load adj)

Key

*	See important installation information on inside front cover
!	Excluding self-leveling suspension
"..."	Special order - phone 010 900 1850. 6-12 week waiting period

~	Imported
#	Internal bump stop
⊕	Steering damper

- It is recommended that all new shock absorbers are fitted in pairs
- Do not mix gas and non-gas units on the same axle
- **Bold** part numbers indicate heavy-duty shocks
- Underlined part numbers indicate parts not immediately available
- *Italic* part numbers followed by > indicate parts to be discontinued

Passenger and light commercial

Part number [alphabetical listing]

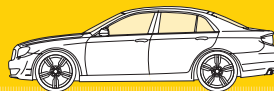

Year	Application	Front					Rear				
		Entry shocks	Premium shocks	Springs	Protection kits/ Mounting kits	Mounting information	Entry shocks	Premium shocks	Springs	Protection kits/ Mounting kits	Mounting information
FORD continued											
Touneo / Transit Custom											
13-22	Touneo Custom 8 seater minibus & Transit Custom van (V36X, F3, FY, FZ) FWD	V4521 OR V4518 OR V4519	—	Springs are model dependant) "SP4273" OR "SP4274" OR "SP4275"	PK435 / MK441	 (Check below diagram for s/span and height differences, or check OE#'s before selection of the front strut)	V1208 OR V2161	—	—	—	 (Check shock open lengths - ref below diagram)
Touneo / Transit Custom											
23-on	Touneo Custom 8 seater minibus & Transit Custom van FWD		—	—	—			—	—	—	
Transit											
13-on	Transit van and bus chassis cab, Gen 4 (V363, FDC, FDD, FED, FFD) RWD	V4521 OR V4518 OR V4519	—	—	PK435 / MK441	 (Check below diagram for s/span and height differences, or check OE#'s before selection of the front strut)	V1208 OR V2161	—	—	—	 (Check shock open lengths - ref below diagram)
FOTON											
Toplander											
15-16	Toplander SUV (U201)	M8066	RS999782	—	—	 S/pan unit Re-use top OE rubbers	M8056	RS999144	—	—	
Thunda											
10-16	Thunda 2.2, 2.8 pick up	GT2021 > / M4462 OR GT2023 / M5468 (Check btm mounting)	—	—	—	(Check btm mounting) GT2021 / M4462 = OR GT2023 / M5468 = 	—	—	—	—	
Tunland											
12-22	Tunland 2.8 4x2 & 4x4 pick up	M8066	RS999782	—	—	 S/pan unit Re-use top OE rubbers	M8056	RS999144	—	—	
Inkunzi											
09-14	Inkunzi 2.2, 15 seater minibus taxi (LWB)	M5464 / GT2094	—	—	—		M8048 / GT2096	—	—	—	

Key

*	See important installation information on inside front cover
!	Excluding self-levelling suspension
...	Special order - phone 010 900 1850. 6-12 week waiting period

~	Imported
#	Internal bump stop
⊕	Steering damper

- It is recommended that all new shock absorbers are fitted in pairs
- Do not mix gas and non-gas units on the same axle
- **Bold** part numbers indicate heavy-duty shocks
- Underlined part numbers indicate parts not immediately available
- *Italic* part numbers followed by > indicate parts to be discontinued

Passenger and light commercial

Part number [alphabetical listing]

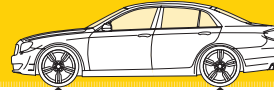

Year	Application	Front					Rear				
		Entry shocks	Premium shocks	Springs	Protection kits/ Mounting kits	Mounting information	Entry shocks	Premium shocks	Springs	Protection kits/ Mounting kits	Mounting information
FOTON <i>continued</i>											
View											
09-12	View panelvan (SWB)	M5464 / GT2094	-	-	-	⊥ ⊕	M8048 / GT2096	-	-	-	○ ○
FUDI											
Lion											
08-15	Lion 2.2, 2.8 4x2 LDV	M5468	-	-	-	⊥ ⊕	M4441	-	-	-	○ ○
GEELY											
Emgrand 7											
12-20	Emgrand (EC7) Sedan 1.8	-	-	-	-		-	-	-	-	
FC											
09-12	FC Sedan	-	-	-	-		-	-	-	-	
J1											
09-12	J1 Hatch 1.3	-	-	-	-		-	-	-	-	
LC / LCX / GC2											
09-on	LC 1.1, 1.3, 1.5 hatch (+ LCX & GC2)	-	-	-	-		-	-	-	-	
MK											
09-on	MK 1.5 Sedan & hatch	-	-	-	-		-	-	-	-	
GOLF CARTS											
Golf Carts											
Various	Golf carts (Check lengths and mounting type & dimensions)	GT1015	-	-	-	⊕ ⊕ 10mm ID eye mtgs / Comp 185mm / Ext 265mm	GT1015 OR GT1026	-	-	-	GT1015 = ⊕ ⊕ 10mm / Comp 222mm / Ext 310mm OR GT1026 = ⊥ ⊕ 10mm OD stud & 10mm ID eye / Comp 302mm / Ext 498mm
							GA2054 > (discontinued) OR GT2007 > (discontinued)				⊥ ⊥ GA2054 Stud OD's 10mm / Comp 185mm / Ext 265mm / GT2007 Stud OD's 10mm / Comp 296mm / Ext 495mm
GONOW											
Inguni											
08-14	Inguni Minibus Taxi	GT2084 / M5464	-	-	-	⊥ ⊕	GT2102 / M8074	-	-	-	○ ○
X-Space											
08-on	X-Space 2.2, 2.8 4x2 LDV	GT2023	-	-	-	⊥ ⊕	GT2024 / M4441	-	-	-	○ ○
GWM											
C10											
12-16	C10 1.5 Hatch	-	-	-	-		G1074	-	-	-	⊥ ○ No top rubber supplied
Hover H3											
08-11	H3 Hover 4x2 & 4x4 SUV	M8031 / GT2084	-	-	-	⊥ ⊕	37272ST	-	-	-	⊥ ⊕ (Top stud 10odx75, btm eye 16idx38)

Key

*	See important installation information on inside front cover
!	Excluding self-levelling suspension
"..."	Special order - phone 010 900 1850. 6-12 week waiting period

~	Imported
#	Internal bump stop
⊕	Steering damper

- It is recommended that all new shock absorbers are fitted in pairs
- Do not mix gas and non-gas units on the same axle
- **Bold** part numbers indicate heavy-duty shocks
- Underlined part numbers indicate parts not immediately available
- *Italic* part numbers followed by > indicate parts to be discontinued

Passenger and light commercial

Part number [alphabetical listing]

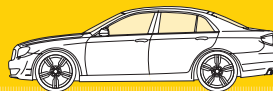

Year	Application	Front					Rear				
		Entry shocks	Premium shocks	Springs	Protection kits/ Mounting kits	Mounting information	Entry shocks	Premium shocks	Springs	Protection kits/ Mounting kits	Mounting information
GWM <i>continued</i>											
H5											
11-16	H5 SUV (X240)	M8031 / GT2084	-	-	-	⊥ ⊕	37272ST	-	-	-	⊥ ⊕ (Top stud 100dx75, btm eye 16idx38)
P-Series											
20-on	P-Series pick-up ("Poer" or "Pao" series)										
Pick-Up											
07-11	GWM pick-up 2.2, 2.8 Tdi 4x2	GT2023	-	-	-	⊥ ⊕	GT2024 / M4441	-	-	-	○ ○
Steed											
08-Oct11	Steed 4x2 & 4x4 LDV ("Wingle" series)	GT2107	-	-	-	⊥ ⊕ S/pan unit	M8032	-	-	-	○ ○
Steed 3											
08-Oct11	Steed 3 4x2 LDV ("Wingle" series)	GT2107	-	-	-	⊥ ⊕ S/pan unit	M8038	-	-	-	○ ○
Steed 5 & 5E											
08-on	Steed 5 & 5E 4x2 & 4x4 LDV ("Wingle" series)	GT2030 / M8058	-	-	-	⊥ ⊕ No s/pan	M8038	-	-	-	○ ○
Steed 6											
14-21	Steed 6 4x2 & 4x4 LDV ("Wingle" series)		-	-	-			-	-	-	⊥ ⊕

HAVAL											
Haval H1											
15-23	Haval H1 SUV gen 2	-	-	-	-		-	-	-	-	
Haval H2											
15-21	Haval H2 SUV	-	-	-	-		-	-	-	-	
Haval H6											
15-20	Haval H6 SUV (gen 1)		-	-	-	(OE# ref 339261 Right) / 339262 Left)		-	-	-	(OE# ref 341492)
17-22	Haval H6C SUV (gen 2)	-	-	-	-		-	-	-	-	
20-on	Haval H6C SUV (gen 3) GT" & HEV Hybrid)	-	-	-	-		-	-	-	-	
Haval H9											
15-on	Haval H9 SUV	-	-	-	-		-	-	-	-	
Jolion											
21-on	Jolion SUV 1.5T "S" & HEV Hybrid)										

HILLMAN											
67-76	Hunter, Minx & Vogue Estate	-	-	-	-	⊥	GT2006	-	-	-	○ ○

HOLDEN											
65-71	All Monaro G.T.S.)	-	-	-	-	⊥ ⊕	"R3216" ~	-	-	-	⊥ ○

HONDA											
Accord											
99-02	Accord Sedan Type-R) 6th Gen (CK, CG, CH, CF)	"G23940"	-	-	MK129	⊥ ⊕ S/pan unit	-	-	-	MK129	⊥ ○ S/pan unit
03-08	Accord Sedan Type-R, ABS & S/W) 7th Gen (CM)	"G1323"	-	-	"PK336" / MK129	⊥ ⊕ S/pan unit / No ABS bracket	"G1316"	-	-	"PK294" / MK129	⊥ ○ S/pan unit
09-12	Accord Sedan & S/W 8th Gen (CU)	-	72562ST	-	MK129	⊥	-	72563ST	-	MK129	⊥
12-17	Accord Sedan 9th Gen (CR)	-	"72970ST" "72971ST"	-	-	⊥	-	"72984ST"	-	-	⊥

Key

*	See important installation information on inside front cover
!	Excluding self-levelling suspension
...	Special order - phone 010 900 1850. 6-12 week waiting period

~	Imported
#	Internal bump stop
⊕	Steering damper

- It is recommended that all new shock absorbers are fitted in pairs
- Do not mix gas and non-gas units on the same axle
- **Bold** part numbers indicate heavy-duty shocks
- Underlined part numbers indicate parts not immediately available
- *Italic* part numbers followed by > indicate parts to be discontinued

Passenger and light commercial

Part number [alphabetical listing]

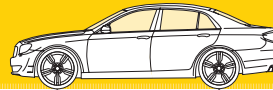

Year	Application	Front					Rear				
		Entry shocks	Premium shocks	Springs	Protection kits/ Mounting kits	Mounting information	Entry shocks	Premium shocks	Springs	Protection kits/ Mounting kits	Mounting information
HONDA continued											
Accord											
03-09	Accord Station Wagon 7th Gen (EXI ABS & sport susp) (CM)	"G1323"	—	—	"PK336" / MK129	⊥ ⊗ No ABS bracket	"G1324"	—	—	"PK294" / MK129	⊥ ○
09-12	Accord Sedan & S/W (EXI ABS) 8th Gen (CU)	—	72562ST	—	MK129	⊥	—	72563ST	—	MK129	⊥
Amaze (for hatch see Brio)											
12-19	Amaze sedan gen 1 (DF1, DF2)	—	744072SP R 744073SP L	—	—	⊥ OE#s 51611TG2T04 / 51621TG2T04 (CN)	—	378047SP	—	—	⊥ ⊗ OE# 52610TG2T04 (CN)
20-on	Amaze sedan gen 2 (DF5, DF6)	—	—	—	—	—	—	—	—	—	—
Ballade / Civic											
82-Mid 84	Ballade Mk2 (OS)	GT7220 >	—	—	—	⊥	—	—	—	—	⊥
Mid 84-88	Ballade Mk3 "Pop-up lights" (SC9)	—	—	—	—	⊥	—	—	—	—	⊥ ⊗ S/pan unit
89-91	Ballade 1500 & 1600 (EXI) local CRX (EXI) those with rear bottom U brackets -> Special order) Mk4 (SH4 / EF)	—	—	—	MK129	⊥ ⊗ S/pan unit	"23748"	—	—	MK129	⊥ ⊗ S/pan unit / Bottom shock mntg is eye
92-95	Ballade All (EXI) local Encore & CRX (EXI) those with rear bottom U brackets) Mk5 SR4 or EG	GT2051 R > GT2052 L > 23787 R 23788 L	—	—	MK129	⊥ ⊗ S/pan unit	"23748"	—	"SP0569" (EXI) 1.6 16v Vtec)	MK129	⊥ ⊗ S/pan unit / Bottom shock mntg is eye
92-95	Ballade All (EXI) imported Encore & CRX (With rear bottom U brackets) Mk5 EG or EH	GT2051 R > GT2052 L > 23787 R 23788 L	—	—	MK129	⊥ ⊗ S/pan unit	23859	—	"SP0569" (EXI) 1.6 16v Vtec)	MK129	⊥ ⊗ S/pan unit / Bottom shock mntg is U bracket
96-March '01	Ballade & Civic (EXI) Vtec (EJ9, EK1, EK3, EK4) Mk6	23858	—	SP1228 (EXI) 1.6 16v Vtec)	MK129	⊥ ⊗	23859	376185SP >	SP2201 (EXI) 1.6 16v Vtec)	"MK345"	⊥ ⊗ S/pan unit / Bottom shock mntg is U bracket
March '01-05	Civic Vtec 4 door Sedan (ES) Mk7	16471 R 16472 L	—	SP3357 (EXI) 1.3)	PK106 / MK220	⊥ (To release piston rod, compress slightly and twist)	23971	—	—	PK107 (Bump rubber only) / MK129	⊥ ⊗ S/pan unit
March '01-05	Civic Vtec 5 door hatch (EP, EU) Mk7 1.3, 1.4, 1.5, 1.6, 1.7i	16471 R 16472 L	—	SP3357 (EXI) 1.3)	PK106 / MK220	⊥ (To release piston rod, compress slightly and twist)	23970	—	SP3358 (3 door)	PK107 (Bump rubber only) / MK129	⊥ ⊗ S/pan unit
	2.0 (EXI) Type R) & 1.7D	"16473" R "16474" L	—	SP3357 (EXI) 2.0)	PK106 / MK220	⊥	23970	—	SP3358 (3 door - EXI) 2.0)	PK107 (Bump rubber only) / MK129	⊥ ⊗ S/pan unit
06-Aug '16	Civic 1.8, 2.2 Hatch Mk8 + Mk9 (FN, FK) (EXI) Type R & Tourer S/W	68169 R 68170 L	—	1,8 = "SP3732"	PK098 / MK354	⊥	G1098	—	1,8 = "SP3659"	—	⊥ ⊗
06-April '11	Civic 1.8 Sedan Mk8 (FD, FA)	—	72286ST R 72287ST L	—	MK354	⊥	—	5609ST	—	—	⊥ ⊗
May '11-Aug '16	Civic Sedan Mk9 (FB, FG)	67473 R 67474 L	350861R R > 350862R L >	—	—	⊥	150863R >	5609ST	—	—	⊥ ⊗
14-15	Civic Tourer station wagon Mk9	—	—	—	—	—	G1098	—	—	—	—
Sept 16-Aug 22	Civic Sedan (FC) 1.5, 1.8 Mk10	—	—	—	—	—	—	"5545ST"	—	—	⊗ ⊗
Sept 16-Aug 22	Civic Hatch (FC, FK) 1.8 (EXI) Type R Mk10	—	—	—	—	—	—	"5545ST"	—	—	⊗ ⊗
Sept 22-on	Civic Sedan (...) 1.5 RS (EXI) Type R (liftback) Mk11	—	—	—	—	—	—	—	—	—	—
Ballade (City)											
11-14	Ballade gen 5 (GM2, GM3)	—	744066SP R 744067SP L	"SP3981"	PK155 / MK336	⊥ (CN)	G1138 > 83831EA	—	"SP3982"	—	⊥ ⊗ (Arg)
End 14-18	Ballade 1.5 gen 6 (GM6)	—	—	—	—	—	—	—	—	—	—
End 19-on	Ballade 1.5 gen 7 (GN2)	—	—	—	—	—	—	—	—	—	—

Key

*	See important installation information on inside front cover
!	Excluding self-leveling suspension
"..."	Special order - phone 010 900 1850. 6-12 week waiting period

~	Imported
#	Internal bump stop
⊗	Steering damper

- It is recommended that all new shock absorbers are fitted in pairs
- Do not mix gas and non-gas units on the same axle
- **Bold** part numbers indicate heavy-duty shocks
- Underlined part numbers indicate parts not immediately available
- *Italic* part numbers followed by > indicate parts to be discontinued

Passenger and light commercial

Part number [alphabetical listing]

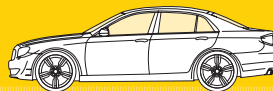

Year	Application	Front					Rear				
		Entry shocks	Premium shocks	Springs	Protection kits/ Mounting kits	Mounting information	Entry shocks	Premium shocks	Springs	Protection kits/ Mounting kits	Mounting information
HONDA continued											
Brio (for sedan see Amaze)											
12-19	Brio hatch gen 1 (DD1, DD2)	–	744072SP R 744073SP L	–	–	OE#s 51611TG2T04 / 51621TG2T04	–	378047SP	–	–	⊥ ⊕ OE# 52610TG2T04
20-on	Brio hatch gen 2	–	–	–	–	–	–	–	–	–	
For Civic ... see Ballade above											
BR-V											
16-21	BR-V 1.5 SUV (DG1, DG2)	–	–	–	–		–	–	–	–	⊥ ⊕
22-on	BR-V 1.5 SUV (DG3)	–	–	–	–		–	–	–	–	⊥ ⊕
CR-V											
98-02	CR-V 4x4 2.0 Gen 1 (RD1 – RD3)	–	<i>D7005</i> > D7005S	SP3483	MK129 (EXL bearings)	⊥ ⊗ Check front shock type	–	<i>D7006</i> > D7006S	SP3484	MK129 (EXL bearings)	⊥ ⊕
02-06	CR-V 4x4 2.0, 2.2 Gen 2 (RD4 – RD8) (Models with Xenon headlights – Check for rear shock bracket)	–	72143ST R 72144ST L	SP3556 (EXL 2.2)	–	 Check front shock type	–	71380 (With- out Xenon h/ light bracket)	SP3557	MK129 (EXL bearings)	⊥ ⊕ S/pan unit (Check for Xenon headlight bracket)
07-12	CR-V 4x4 2.0, 2.2, 2.4 Gen 3 (RE) (Models with Xenon headlights – Check for rear shock bracket)	–	72491ST R 72492ST L	–	MK360 (EXL bearings)		–	72497ST (Without Xenon h/light bracket)	–	MK129 (EXL bearings)	⊥ ⊕ S/pan unit (Check for Xenon headlight bracket)
End 12-14	CR-V 4x4 2.0, 2.2, 2.4 Gen 4 (RM)	–	72491ST R 72492ST L	–	MK360 (EXL bearings)		–	72957ST	–	–	⊥ ⊕ S/pan unit
End 15- July17	CR-V 4x4 2.0, 2.2, 2.4 Gen 4 (RM) facelift	–	73046ST R > 73046ST L > 72491ST R 72492ST L	–	MK360 (EXL bearings)		–	72957ST	–	–	⊥ ⊕ S/pan unit
Aug17-23	CR-V 4x4 1.5T, 2.0 Gen 5 (RW)	–	73097ST R 73098ST L	–	–		–	37382ST	–	–	⊥ ⊕ No s/pan unit
24-on	CR-V 4x4 Gen 6 (RS)	–	–	–	–	–	–	–	–	–	–
CR-Z											
10-16	CR-Z Hybrid coupe (ZF1)	–	–	–	–	–	–	"5682ST"	–	–	⊥ ⊕
For Honda Fit ... see Jazz											
FR-V											
05-09	FR-V mini-MPV 2.0	–	–	–	–	–	–	–	–	–	–
HR-V											
02-06	HR-V 4x4 1.6 (GH2) AWD & (GH1) 4x2	–	"D0007R / D0008L"	–	–		–	"D7001S"	–	–	⊥ / ⊕
15-22	HR-V 4x4 1.5, 1.8 (RU5) 4x2	–	–	–	–		–	–	–	–	–
22-on	HR-V 4x4 1.5 (RV) 4x2	–	–	–	–		–	–	–	–	–
Insight											
11-14	Insight Hybrid (ZE2) gen 2	–	–	–	–	–	–	–	–	–	–
Jazz / Fit											
03-04	Jazz 1.4 Dsi & 1.5 Vtec gen 1 (GD)	G7271 R G7272 L	–	SP3359	PK155 / MK336		23968	–	SP3360	–	⊥ ⊕
05-07	Jazz 1.4 Dsi & 1.5 Vtec gen 1 (GD facelift)	G7275 R G7276 L	–	SP3359	PK155 / MK336		23968	–	SP3360	–	⊥ ⊕

Key

*	See important installation information on inside front cover
!	Excluding self-levelling suspension
"..."	Special order – phone 010 900 1850. 6-12 week waiting period

~	Imported
#	Internal bump stop
⊕	Steering damper

- It is recommended that all new shock absorbers are fitted in pairs
- Do not mix gas and non-gas units on the same axle
- **Bold** part numbers indicate heavy-duty shocks
- Underlined part numbers indicate parts not immediately available
- *Italic* part numbers followed by > indicate parts to be discontinued

Passenger and light commercial

Part number [alphabetical listing]

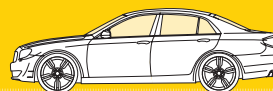

Year	Application	Front					Rear				
		Entry shocks	Premium shocks	Springs	Protection kits/ Mounting kits	Mounting information	Entry shocks	Premium shocks	Springs	Protection kits/ Mounting kits	Mounting information
HONDA continued											
Jazz / Fit continued											
08-Jan'15	Jazz 1.4 Dsi & 1.5 Vtec gen 2 (GE)	—	744066SP R 744067SP L	SP3981	PK155 / MK336	 (CN)	83831EA	—	SP3982	—	\perp \oplus (Arg)
Feb'15- June '21	Jazz 1.2, 1.5 gen 3 (GK)										
July '21-on	Jazz 1.5 gen 4 (GR/GS)										
Mobilio											
14-16	Mobilio MPV			—					—		
Odyssey / Shuttle											
95-99	Odyssey Type RA1, RA3	"23874" R "23875" L	—	—	—	\perp \otimes	"23871"	—	—	—	\perp \circ
WR-V											
2020-2022	WR-V SUV (GL) gen 1										
2023-on	WR-V SUV 1.2 (DG4) gen 2										

For Hover ... see GWM

HUMMER

H3											
05-11	H3 Std height	911527MM >	RS999307 Std ht	—	—	\perp T	—	RS999308 Std ht	—	—	\oplus \oplus
	Raised 100mm	—	RS999309 > raised 100mm	—	—		—	RS999310 > raised 100mm	—	—	

HYUNDAI

Accent											
94-May'97	Accent I (X3)	R7101 R - R7102 L -	—	"SP0032"	PK143 - / MK210 (incl bearings)		10049 R 10050 L	—	"SP0582"	PK008 / MK222 (incl bearings)	 (Smaller rear s/pan)
June'97- June'00	Accent I (X3) facelift (Larger rear s/pan than earlier model)	R7101 R - R7102 L -	—	"SP0032"	PK144 / MK210 (incl bearings)		R7001 R - R7002 L -	—	—	PK143 - / MK222 (incl bearings)	 (Larger rear s/pan)
July'00-05	Accent II (LC)	11339 R 11340 L	—	SP2505	MK210		R7001 R - R7002 L -	—	—	PK143 - / MK222 (incl bearings)	
06-July'11	Accent III (MC)	—	72297ST R 72298ST L	"SP3684" (EXCL Diesel)	PK183 / MK337 (incl bearings) OR MK001 (bearings only)		—	5621ST	"SP3686"	PK297 >	\perp \circ
Aug'11-20	Accent IV i25 (RB)	—	72706ST R 72707ST L	—	MK460 (EXCL bearings) + MK405 (bearing only)		G2223	—	—	PK381 /	\circ \circ
Atos											
00-08	Atos & Atos Prime (FF/MX)	G16312 R G16313 L	—	"SP3673" (1.1)	"PK182" / "MK267"		G22709	—	"SP3674" (1.1)	—	\circ \circ
19-on	Atos 1,1 (AH2)			—	—				—	—	
Azera											
06-11	Azera sedan 3.3 V6 (TG)	—	72281ST	—			—	—	—	—	\perp \oplus
Creta / iX25											
17-Oct 20	Creta SUV gen 1 (GS/GC)			—	MK516 (incl bearings)				—	—	
Nov 20-on	Creta 1,4, 1,5 SUV gen 2 (SU2)			—	—				—	—	

Key

*	See important installation information on inside front cover
!	Excluding self-levelling suspension
"..."	Special order – phone 010 900 1850. 6-12 week waiting period

~	Imported
#	Internal bump stop
\oplus	Steering damper

- It is recommended that all new shock absorbers are fitted in pairs
- Do not mix gas and non-gas units on the same axle
- **Bold** part numbers indicate heavy-duty shocks
- Underlined part numbers indicate parts not immediately available
- *Italic* part numbers followed by > indicate parts to be discontinued

Passenger and light commercial

Part number [alphabetical listing]

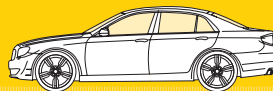

Year	Application	Front					Rear				
		Entry shocks	Premium shocks	Springs	Protection kits/ Mounting kits	Mounting information	Entry shocks	Premium shocks	Springs	Protection kits/ Mounting kits	Mounting information
HYUNDAI continued											
Grand Creta											
22-on	Grand Creta SUV 1.5, 2.0		–	–	–			–	–	–	
Elantra											
91-95	Elantra gen 1 (J1)	G16555	–	–	–		–	–	–	–	
96-Aug'00	Elantra Sedan & S/W gen 2 (J2)	16244 R 16245 L	–	–	PK143 > / "MK227"		G16248 R G16249 L	–	–	MK211R & MK212L	
Aug'00- Oct'06	Elantra Sedan & S/W gen 3 (XD)	G16351 R G16352 L	–	1.6 & 1.8=SP2534 > 2.0 = SP2535 >	PK183 / "MK227"		–	71406ST R 71407ST L	SP2509 > (EXCL S/W)	MK211R & MK212L	
Nov'06- July'11	Elantra Sedan gen 4 (HD)	–	72305ST R > 72306ST L >	–	MK332		–	5622ST	–	–	
Aug'11- June'16	Elantra Sedan gen 5 (MD)	–	72708ST R 72709ST L	–	MK516 (EXCL bearings)		G2229	–	–	–	
July '16-19	Elantra Sedan gen 6 (AD)	–	–	–	/ MK514 (EXCL bearings)		–	–	–	–	
Excel / Pony											
89-94	Excel / Pony	–	–	–	–		"23442"	–	–	–	
Getz											
03-11	Getz (TB)	R7613 R ~ R7614 L ~	–	1.1 & 1.3 = SP3554	PK183 / MK210		G21659	–	SP3555	PK445	
H-1 / Starex											
09-21	H-1 Minibus 9 seater / Van gen 2 (TQ) EXCL facelifts	V4306A R V4307A L	–	–	–		V2158	–	–	–	
H100 / Porter											
96-on	H100 Bakkie Dropside LDV gen 3 & 4	M8047 / G12094	–	–	–		M8038	–	–	–	
i10 (Incl Grand i10)											
08-18	i10 Hatch gen 1 (PA)	G7023 R G7024 L	–	SP3943 (EXCL diesel)	PK337 / MK469		G1111	–	SP3960	–	
June'14- July'20	Grand i10 Hatch 1,25 gen 2 (BA)	G7923 R G7924 L	–	–	PK461 / MK488		G1266	–	–	PK298	 (No dust cover)
Aug'20-on	Grand i10 Hatch 1,0 gen 3 (A13) EXCL Cargo and Sedan from 2023	–	–	–	–		–	–	–	–	
i20											
09-'12	i20 Hatch (PB) gen 1	G7115 R G7116 L	–	SP3941 (petrol only) OR "SP3942" (Diesel CRDi only)	PK369 / MK460 (EXCL bearings) + MK405 (bearing only)		G2223	–	SP3961	PK381	
13-Jan'15	i20 Hatch (PB) gen 1 – facelift	G7117 R G7118 L	–	SP3941 (petrol only) OR "SP3942" (Diesel CRDi only)	PK369 / MK460 (EXCL bearings) + MK405 (bearing only)	 (OE#'s 546601J051, ...151, ...351 / 546501J051, ...151, ...351)	G2223	–	SP3961	PK381	
Feb'15-20	i20 Hatch (GB) gen 2 (EXCL "Active" that has increased ground clearance)	G7780 R G7781 L	–	–	MK479 (EXCL bearings)	 (CN via EU) (OE# 54650601J451 has a "flat" on the top of the rod)	G1347	–	–	–	 (No dust cover)
21-on	i20 Hatch 1,2 (B13) gen 3	–	–	–	–		–	–	–	–	
i20 Active											
18-20	i20 Hatch Active Crossover 1.4 (GB) gen 2 (has increased ground clearance) EXCL i20N	–	–	–	MK479 (EXCL bearings)	 (20mm higher)	G1350	–	–	–	 (No dust cover) (20mm higher) OE#'s 55310C8200 / 55310C8300

Key

*	See important installation information on inside front cover
!	Excluding self-levelling suspension
"..."	Special order – phone 010 900 1850. 6-12 week waiting period

~	Imported
#	Internal bump stop
	Steering damper

- It is recommended that all new shock absorbers are fitted in pairs
- Do not mix gas and non-gas units on the same axle
- **Bold** part numbers indicate heavy-duty shocks
- Underlined part numbers indicate parts not immediately available
- *Italic* part numbers followed by > indicate parts to be discontinued

Passenger and light commercial

Part number [alphabetical listing]

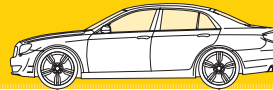

Year	Application	Front					Rear				
		Entry shocks	Premium shocks	Springs	Protection kits/ Mounting kits	Mounting information	Entry shocks	Premium shocks	Springs	Protection kits/ Mounting kits	Mounting information
HYUNDAI continued											
i30											
09-June '12	i30 Hatch (FD) gen 1	G7338 R G7339 L	—	SP3741 EXCL diesel)	PK295 / MK332 OR MK001 (bearing only)		G1094	—	SP3743	PK300	 (bottom U bracket / No dust cover)
July '12-16	i30 Hatch (GD) gen 2	G8216 R G8217 L	—	—	MK475		G1094 (OR G2223 if the shocks have eye mounting top & bottom)	—	—	PK300 (for G1094)	G1094 = (Bottom U bracket & no dust cover) OR G2223 =
17-18	i30 Hatch gen 3 (PD) EXCL 2.0T i30N performance model	—	—	—	MK514 INCL bearings)		—	"376265SP"	—	—	 (No dust cover)
iX35											
10-March '16	iX35 4x2 (LM) gen 2	G8176 R G8177 L	—	SP3936 EXCL CRDi) OR SP3937 (CRDi only)	PK368 / MK408A INCL bearings)		G1148 > G1148A	—	SP3934	MK455 EXCL bearings)	 (Bottom U bracket)
10-March '16	iX35 4x4 (LM) gen 2	G8176 R G8177 L	—	SP3937	PK368 / MK408A INCL bearings)		G1150	—	SP3935	MK455 EXCL bearings)	
For new iX35 ... see Tucson											
Kona											
18-23	Kona Cross-over SUV FWD 1.0T, 1.6T-Gdi & 2.0 gen 1 (OS)	—	—	—	MK514 INCL bearings)		G1439	—	—	MK515 EXCL bearings)	
24-on	Kona Cross-over SUV gen 2 (SX2)	—	—	—	—		—	—	—	—	—
Matrix											
02-10	Matrix Mini MPV (FC)	16361 R 16362 L	—	—	"PK344" / "MK227" INCL bearings)		G7298 R G7299 L	—	—	MK211R & MK212L	
Palisade											
22-on	Palisade 7 seater SUV 2.2 4x4 (LX2)	—	—	—	—		—	—	—	—	—
Santa Fe											
01-06	Santa Fe 4x2 & 4x4 Gen 1 (SM)	—	71435 R 71436 L	"SP2538"	"PK344" / MK213		—	D8020 > D8020S	"SP2503"	"PK296" / MK316"	 Check rear mountings to get right model
07-09	Santa Fe 4x2 & 4x4 Gen 2 (CM) EXCL elec or self-levelling susp)	G8150 R G8151 L (Larger s/pan)	—	"SP3851" (4x2 2.7 only)	PK160 / MK304A"	 Check s/pan diameter (large) - For OE#s 546602B200 / 201, 546502B200 / 201, EXCL OE# 546502B540	G2122	—	"SP3853" 4x2 EXCL 2.0 & 2.4) "SP3854" 4x4 EXCL 2.0 & 2.4)	—	 Check rear mountings to get right model
09-12	Santa Fe 4x2 & 4x4 Gen 2 (CM) EXCL elec or self-levelling susp)	G8406 R G8407 L (Smaller s/pan)	—	"SP3851" (4x2 2.7 only)	—	 Check s/pan diameter (small). OE# 546602B510	G2122	—	"SP3853" 4x2 EXCL 2.0 & 2.4) "SP3854" 4x4 EXCL 2.0 & 2.4)	—	
13-Sept 18	Santa Fe 4x2 5 & 7 seater Gen 3 (DM) EXCL elec or self-levelling susp)	G8218 R G8219 L	—	—	—		G2227 !	—	—	—	 (4x2) OE #s 553102W010 / ..110
13-Sept 18	Santa Fe 4x4 5 & 7 seater Gen 3 (DM) EXCL elec or self-levelling susp)	G8218 R G8219 L	—	—	—		G2228 !	—	—	—	 (4x4) OE #s 553102W210 / ..310 / ..320 / ..350
Oct 18-on	Santa Fe 2.2 Gen 4 (TM) 4x2, 4x4	—	—	—	—		—	—	—	—	—

Key

*	See important installation information on inside front cover
!	Excluding self-levelling suspension
"..."	Special order - phone 010 900 1850. 6-12 week waiting period

~	Imported
#	Internal bump stop
	Steering damper

- It is recommended that all new shock absorbers are fitted in pairs
- Do not mix gas and non-gas units on the same axle
- **Bold** part numbers indicate heavy-duty shocks
- Underlined part numbers indicate parts not immediately available
- *Italic* part numbers followed by > indicate parts to be discontinued

Passenger and light commercial

Part number [alphabetical listing]

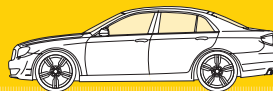

Year	Application	Front					Rear				
		Entry shocks	Premium shocks	Springs	Protection kits/ Mounting kits	Mounting information	Entry shocks	Premium shocks	Springs	Protection kits/ Mounting kits	Mounting information
HYUNDAI continued											
Sonata											
94-98	Sonata (Y3) gen 3	16734 >	-	-			"23810" >	-	-		
00-01	Sonata (EF) gen 4	-		-	"MK215"		-	"71326"	-	"MK215"	 S/pan unit
01-'9/05	Sonata (EF-B) gen 4 facelift	-	"71417" >	-	"MK215"		-	"71326"	-	"MK215"	 S/pan unit Check rear shock type
10/05-9/10	Sonata (NF) gen 5	-	<u>72281ST</u> >	-	"PK347" / "MK338"		-	5614ST >	-	-	 No s/pan Check rear shock type
10/10-early '15	Sonata (YF) gen 6	-	-	-	-		-	5646ST	-	-	 Bottom U bracket
Staria											
22-on	Staria 2,2 minibus, multicab & panel van (US4)										
Terracan											
01-07	Terracan 4x4 2.9 CRDi, 3.5 V6	-	<u>D8014</u> > <u>D8014S</u>	-	-		-	<u>D8015</u> > <u>D8015S</u>	-	-	
Tiburon / Scoupe											
90-97	Scoupe	-	-	-	-		"23442"	-	-	-	
97-02	Tiburon coupe (RD)	16244R 16245L	-	-	"MK227"		G16248R G16249L	-	-	MK211R & MK212L	
02-08	Tiburon Coupe (GK)	-	-	-	MK001		-	<u>72193ST</u> R > <u>72194ST</u> L >	-	-	
Trajet											
01-08	Trajet 2.0d & 2.7 MPV (FO)	"G8093" R "G8094" L	-	-	"PK344"		"23974"	-	-	-	 ID = 12.2mm Check eye mounting ID size and OE#: 553003A010, 553003A510
Tucson											
04-10	Tucson All (JM) gen 1	-	<u>72219ST</u> R <u>72220ST</u> L	SP3532 (<u>300</u> 4x2 & 2.0 petrol)	PK160 / MK213		-	<u>72221</u> R <u>72222</u> L	SP3533 (<u>300</u> 4x2)	PK160 / MK211R & MK212L	
For Tucson gen 2 ... see iX35											
April 16-22	Tucson All (TL) gen 3		<u>742281SP</u> R <u>742282SP</u> L	SP4252 4x2 (<u>300</u> 2,0 Diesel CRDi) / SP4253 4x2 2,0 Diesel CRDi / SP4254 4x4 Petrol / SP4255 4x4 2,0 Diesel CRDi	/ MK483			376252SP	4x2 = SP4256 / 4x4 = SP4257	/ MK455	
22-on	Tucson All (NX4) gen 4 2,0 FWD										
Veloster											
13-17	Veloster 3 door coupe (FS)		-	-	/ "MK516"		G2229	<u>5671ST</u> >	-	-	
Venue											
19-on	Venue SUV 1.0 TDGi, 1.2 MPi (QX)		-	-	-			-	-	-	

Key

*	See important installation information on inside front cover
!	Excluding self-levelling suspension
"..."	Special order - phone 010 900 1850. 6-12 week waiting period

~	Imported
#	Internal bump stop
	Steering damper

- It is recommended that all new shock absorbers are fitted in pairs
- Do not mix gas and non-gas units on the same axle
- **Bold** part numbers indicate heavy-duty shocks
- Underlined part numbers indicate parts not immediately available
- *Italic* part numbers followed by > indicate parts to be discontinued

Passenger and light commercial

Part number [alphabetical listing]

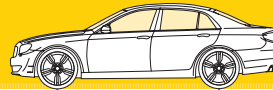

Year	Application	Front					Rear				
		Entry shocks	Premium shocks	Springs	Protection kits/ Mounting kits	Mounting information	Entry shocks	Premium shocks	Springs	Protection kits/ Mounting kits	Mounting information
ISUZU											
For older KB / D-Max models ... see Isuzu KB											
D-MAX											
21-on	D-Max 4X2 Std Height (30) Hi-Rider RG series										
21-on	D-Max 4X4 & 4x2 Hi-Rider raised body RG series										
	Raised 30mm to 60mm	-	-	-	-		-	-	-	-	
Frontier											
98-mid 03	Frontier Wagon, All 4x2 and 4X4 (MCI facelift)	M5464 / GT2084	RS999214	-	-	⊥ ⊕	M4464	-	-	-	⊥ ⊙
KB / D-MAX											
78-Mid 81	KB10, KA20, KA25	GA2009 > / GT2009	"D2113S"	-	-	⊥ ⊕	M8038	-	-	-	⊙ ⊙
Mid 81-89	KB21, KB23, KB28, KBD22, KBD27 4X2	GT2021 > / M4462	-	-	-	⊥ ⊕	GT2024 / M4441	RS999116	-	-	⊙ ⊙
Mid 81-89	KB41, KB43, KBD42 4x4	GA2009 > / GT2009	"D2113S"	-	-	⊥ ⊕	M4441 / GT2024	RS999116	-	-	⊙ ⊙
89- June 04	KB 4x2 std height (30) raised body & KB320) TF Series	M8046 / GT2025	-	-	-	⊥ ⊕	GT2024 / M4441	RS999116	-	-	⊙ ⊙
89- June 04	KB 4x4 & Raised body 4x2 (MCI all KB320) TF Series	M5464 / GT2084	RS999214	-	-	⊥ ⊕	M4441 / GT2024	RS999116	-	-	⊙ ⊙
July 04- March 13	KB 4X2 Std Height P190 (30) Hi-Rider) RA / RC series	GT2107 *7	-	-	-	⊥ ⊙ S/pan unit	M8032	-	-	-	⊙ ⊙
July 04- March 13	KB 4X4 P190 & 4x2 Hi-Rider raised body RA / RC series Std height	M8031	RS999214	-	-	⊥ ⊙ Torsion bars	M8032	RS999341 (Note this unit is 29mm shorter than OE)	-	-	⊙ ⊙
	Raised 40mm to 70mm		RS999136	-	-	40 mm longer		RS999116	-	-	40 mm longer
April '13-'21	KB / D-Max 4X2 Std Height P190 / RT50 / RT85 (30) Hi-Rider) RT series	M8095	-	-	-	⊥ ⊙ S/pan unit	M8089	-	-	-	⊙ ⊙
April '13-'21	KB / D-Max 4X4 P190 / RT50 / RT85 & 4x2 Hi-Rider raised body RT series	M8088	RS55779A	-	-	⊥ ⊙ S/pan unit / Reuse OE washers	M8089	RS55021D	-	-	⊙ ⊙
	Raised 30mm to 60mm	AU360881	"RS55779B"	RS40019	-	30mm longer	AU160882	"RS55021C"	-	-	50 mm longer
For KB / D-Max models from 2020 ... see Isuzu D-Max											
MU-X											
18-21	MU-X 3.0 SUV gen 1 (RF20)		-	-	-			-	-	-	
21-on	MU-X 3.0 SUV gen 2 (RJ)		-	-	-			-	-	-	
Trooper											
83-86	Trooper UBS 52 series	GT2009	"D2113S"	-	-	⊥ ⊕	-	"D8004S"	-	-	⊙ ⊙
87-91	Trooper UBS 12/52 series	M5464	RS999214	-	-	⊥ ⊕	M4464	-	-	-	⊥ ⊙
92-02	Trooper UBS 69 series	M5464	RS999214	-	-	⊥ ⊕	M4441	"AU160369"	-	-	⊕ ⊙
97-02	Trooper UBS 26/73 series	M5464	RS999214	-	-	⊥ ⊕	M4441	"AU160369"	-	-	⊙ ⊙
WFR / Relay											
84-95	WFR Van & Bus (MCI Relay)	-	-	-	-	⊥ ⊕	M4441	-	-	-	⊙ ⊙

Key	
*	See important installation information on inside front cover
!	Excluding self-levelling suspension
"..."	Special order - phone 010 900 1850. 6-12 week waiting period

~	Imported
#	Internal bump stop
⊕	Steering damper

- It is recommended that all new shock absorbers are fitted in pairs
- Do not mix gas and non-gas units on the same axle
- **Bold** part numbers indicate heavy-duty shocks
- Underlined part numbers indicate parts not immediately available
- *Italic* part numbers followed by > indicate parts to be discontinued

Passenger and light commercial

Part number [alphabetical listing]

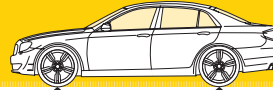

Year	Application	Front					Rear				
		Entry shocks	Premium shocks	Springs	Protection kits/ Mounting kits	Mounting information	Entry shocks	Premium shocks	Springs	Protection kits/ Mounting kits	Mounting information
IVECO											
Daily I											
All up till '89	30.8, 35.8, 35.10, 40.8, 40.10, 45.10, 49.10 (Check OE numbers)	V1055 *13 OR "V1079" *13	-	-	-	⊖ ⊖ V1055 = OE# 8587219 or "V1079" = OE# 93803675 / 93803892 / 4829233	"V1056"	-	-	-	⊖ ⊖ 12id bush OE # 4829235, 8586273, 93800199, 93804439, EXCI 4829235
Daily II											
89-99	30.8, 35.8, 35.10, 40.8 Leaf spring rear (Check OE numbers)	"V1102"	-	-	-	⊖ ⊖ OE#: 4829234, 8574216, 93826662	"V1103"	-	-	-	⊖ ⊖ OE#s: 4835372, 4835373, 4835375, 4850528
89-99	35.8, 35.10, 40.10 Leaf spring rear Chassis #'s 5973717 -> on (Check OE numbers)	"V1102"	-	-	-	⊖ ⊖ OE#: 4829234, 8574216, 93826662	V2110	-	-	-	⊖ ⊖ 30mm shorter than V1103 OE#: 93826664, 98449030
Daily III 4x2											
99-06	29.....	V1195 OR V1197 ...check OE #s	-	-	-	⊖ ⊖ OE#: V1195 = 504051656, 5801345779 or V1197 = 504110593, 504118348, 504195995, 504198992, 5801345771, 5801345780	V2135 OR V2136 Air susp OR V1191 ... Check OE#s	-	-	-	⊖ ⊖ OE#s: V2135 = 2997280, 500368633, 500368634, 500376000, 500376001, 500376002, 500389135, 500389838, 500389841, 500392353, 500392553, 504039594, 504039594, 504064549, 504064551, 5801345778 V2136 = 500378189, 500378190, 504043876, 504043882, 504064993, 504069580, 504152184, 5801345777 V1191 = 504118330, 5801345772
99-06	35C....	V1201 (std susp) OR V1195 OR V1502 (std susp) OR V1197 ...check OE#s	-	-	-	⊖ ⊖ OE#s: V1201 = 504118552, 504118933, 504152175, 5801345773 V1195 = 504051656, 5801345779 V1502 = 500368632, 500369622, 500389134, 500389136, 500389837, 500389839, 504043715, 504043879, 5801345781, 908272969, 908322970 V1197 = 504110593, 504118348, 504195995, 504198992, 5801345771, 5801345780	V2515 (std susp) OR V2136 (Air susp) OR V2516 (Multi-link susp) OR V2135 OR V1191 (std susp) check OE#s	-	-	-	⊖ ⊖ OE#s : V2515 (see be- low) V2136 500378189, 500378190, 504043876, 504043882, 504064993, 504069580, 504152184, 5801345777 V2516 500367642, 500369632, 504043717, 504043883, 504088408, 504088409, 504152176, 5801345775 V2135 500389135, 500389841, 504043881, 504064549, 500368633, 500368634, 500376000, 500376001 V1191 504118330, 5801345772
99-06	40C..., 45C... & 50C...	V2516 (Mul- ti-link susp)	-	-	-	⊖ ⊖	V2515 (std susp)	-	-	-	⊖ ⊖
99-06	65C...	V2518	-	-	-	⊖ ⊖	V2515	-	-	-	⊖ ⊖
Daily IV 4x2											
06-11	29...		-	-	-		V2136 (Air susp) OR V1191 (std susp) ... check OE#s	-	-	-	⊖ ⊖

Key

*	See important installation information on inside front cover
!	Excluding self-levelling suspension
"..."	Special order - phone 010 900 1850. 6-12 week waiting period

~	Imported
#	Internal bump stop
⊖	Steering damper

- It is recommended that all new shock absorbers are fitted in pairs
- Do not mix gas and non-gas units on the same axle
- **Bold** part numbers indicate heavy-duty shocks
- Underlined part numbers indicate parts not immediately available
- *Italic* part numbers followed by > indicate parts to be discontinued

Passenger and light commercial

Part number [alphabetical listing]

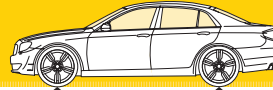

Year	Application	Front					Rear				
		Entry shocks	Premium shocks	Springs	Protection kits/ Mounting kits	Mounting information	Entry shocks	Premium shocks	Springs	Protection kits/ Mounting kits	Mounting information
IVECO continued											
Daily IV continued											
06-11	35S..., 35C..., 40C.. 45C.. & 50C..	<u>V1201</u> (std susp) OR <u>V1502</u> (std susp) OR <u>V2516</u> (multi-link axle) check OE#s	-	-	-	⊖ ⊖ OE#s: V1201 = 504118552, 504118933, 504152175, 5801345773 or V1502 = 500368632, 500369622, 500389134, 500389136, 500389837, 500389839, 504043715, 504043879, 5801345781, 908272969, 908322970 or V2516 = 500367642, 500369632, 504043717, 504043883, 504088408, 504088409, 504152176, 5801345775	<u>V2136</u> (35S) OR <u>V2151</u> (Air susp) OR <u>V2515</u> (std susp) OR <u>V1191</u> ... check OE#s	-	-	-	⊖ ⊖ V2136 OE#s: 500378189, 500378190, 504043876, 504043882, 504064993, 504069580, 504152184, 5801345777 V2151 = OE#s: 504170986 or V2515 (see below for OE#s) or V1191 OE#s: 504118330, 5801345772
06-11	60C..., 65C..., 70C...	<u>V2518</u>	-	-	-	⊖ ⊖	<u>V2152</u> (Air susp) OR <u>V2515</u> (std susp) ... check OE#s	-	-	-	⊖ ⊖ OE#s: 504190986 V2515 OE#s: 2997265, 4854829, 500305418, 500337443, 500367032, 500368636, 500369631, 500369633, 500377620, 500377621, 500377633, 500377634, 500389137, 500398555, 503642705, 504043716, 504043718, 504043880, 504043884, 504152179, 504152182, 5801345774, 5801345776, 5801345776.
Daily V 4x2											
11-14	35C..., 40C..., 50C...	<u>V2516</u> (Multi-link axle) OR <u>V1197</u> multi-link axle) - check OE#s	-	-	-	⊖ ⊖ OE#s: V2516 = 500367642, 500369632, 504043717, 504043883, 504088408, 504088409, 504152176, 5801345775 or V1197 = 504110593, 504118348, 504195995, 504198992, 5801345771, 5801345780	<u>V2515</u> (std susp) OR <u>V2136</u> (35S Air susp) OR <u>V2151</u> (Air susp) ... check OE#s	-	-	-	⊖ ⊖ V2515 (see below for OE#s) V2136 OE#s: 500378189, 500378190, 504043876, 504043882, 504064993, 504069580, 504152184, 5801345777 V2151 OE#s: 504170986
11-14	65C..., 70C...	<u>V2518</u>	-	-	-	⊖ ⊖	<u>V2152</u> (Air susp ... check OE#s) <u>V2515</u> (Std susp ... check OE#s)	-	-	-	⊖ ⊖ V2152 : OE#s: 504190986 V2515 OE#s: 2997265, 4854829, 500305418, 500337443, 500367032, 500368636, 500369631, 500369633, 500377620, 500377621, 500377633, 500377634, 500389137, 500398555, 503642705, 504043716, 504043718, 504043880, 504043884, 504152179, 504152182, 5801345774, 5801345776, 5801345776.

Key	
*	See important installation information on inside front cover
!	Excluding self-levelling suspension
...	Special order - phone 010 900 1850. 6-12 week waiting period

~	Imported
#	Internal bump stop
⊖	Steering damper

- It is recommended that all new shock absorbers are fitted in pairs
- Do not mix gas and non-gas units on the same axle
- **Bold** part numbers indicate heavy-duty shocks
- Underlined part numbers indicate parts not immediately available
- *Italic* part numbers followed by > indicate parts to be discontinued

Passenger and light commercial

Part number [alphabetical listing]

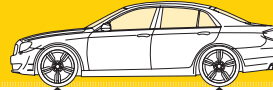

Year	Application	Front					Rear				
		Entry shocks	Premium shocks	Springs	Protection kits/ Mounting kits	Mounting information	Entry shocks	Premium shocks	Springs	Protection kits/ Mounting kits	Mounting information
IVECO continued											
Daily VI 4x2											
14-on	35S..., 35C..., 40C..., 50C...	<u>V2159</u> (33, 35 multi-link) or <u>V2516</u> (35, 40, 45, 50 Multi-link axle) – check OE#’s	–	–	–	⊖ ⊖ OE#’s: V2159 = 5801564243, 5801564828, 5801771684, 5801771698 or V2516 = 500367642, 500369632, 504043717, 504043883, 504088408, 504088409, 504152176, 5801345775	<u>V2515</u> (35, 40, 45, 50 std susp duel tyres... check OE#’s) or <u>V2136</u> (33, 35S Air susp single tyres... check OE#’s) or <u>V2151</u> (35C, 40, 45, 50 Air susp duel tyres... check OE#’s) or <u>V1207</u> (35, 40, 45 std susp single tyres... check OE#’s) or <u>V1206</u> (33, 35S std susp single tyres... check OE#’s)	–	–	–	⊖ ⊖ V2515 (see below for OE#’s) V2136 OE#’s: 500378189, 500378190, 504043876, 504043882, 504064993, 504069580, 504152184, 5801345777, V2151 OE#’s: 504170986 V1207 OE#’s: 5801771631 / 5801586618 V1206 OE#’s: 5801586617, 5801771630
14-on	60C..., 65C..., 70C... rear duel tyres	<u>V2518</u>	–	–	–	⊖ ⊖	<u>V1207</u> (60C std susp single tyres... check OE#’s) or <u>V2515</u> (Std susp – duel tyres – check OE#’s) or <u>V2152</u> (Air susp – duel tyres – check OE#’s)	–	–	–	⊖ ⊖ V1207 OE#’s: 5801771631 / 5801586618 V2515 OE#’s: 2997265, 4854829, 500305418, 500337443, 500367032, 500368636, 500369631, 500369633, 500377620, 500377621, 500377633, 500377634, 500389137, 500398555, 503642705, 504043716, 504043718, 504043880, 504043884, 504152179, 504152182, 5801345774, 5801345776, V2152 OE#’s: 504190986
Daily S2000											
99-06	29 L & 35 S Series (Check OE numbers)	<u>V1502</u>	–	–	–	⊖ ⊖ OE#’s: 500368632, 500389134, 500389136, 500389837, 500389839, 504043715, 504043879	<u>V2135</u> *13 or <u>V2136</u> *13	–	–	–	⊖ ⊖ V2135 OE#’s: 500389135, 500389841, 504043881, 504064549, 500368633, 500368634, 500376000, 500376001 V2136 OE#’s: 500378189, 500378190, 504043882
99-06	35 C & 40 C Series (Check OE numbers)	<u>V1502</u> *13 or <u>V2516</u> *13	–	–	–	⊖ ⊖ V1502 OE#’s: 500368632, 500389134, 500389136, 500389837, 500389839, 504043715, 504043879 V2516 OE#’s: 500367642, 500369632, 504043717, 504043883, 504088408, 504088409	<u>V2515</u>	–	–	–	⊖ ⊖ OE#’s: 500367032, 500369633, 504043718, 504043884

Key

*	See important installation information on inside front cover
!	Excluding self-levelling suspension
"..."	Special order – phone 010 900 1850. 6-12 week waiting period

~	Imported
#	Internal bump stop
⊖	Steering damper

- It is recommended that all new shock absorbers are fitted in pairs
- Do not mix gas and non-gas units on the same axle
- **Bold** part numbers indicate heavy-duty shocks
- Underlined part numbers indicate parts not immediately available
- *Italic* part numbers followed by > indicate parts to be discontinued

Passenger and light commercial

Part number [alphabetical listing]

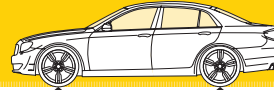

Year	Application	Front					Rear				
		Entry shocks	Premium shocks	Springs	Protection kits/ Mounting kits	Mounting information	Entry shocks	Premium shocks	Springs	Protection kits/ Mounting kits	Mounting information
IVECO continued											
Daily S2000 continued											
99-06	50 C Series (incl 40 C & 50 C bus)	V2516	-	-	-	⊖ ⊖ OE#s: 500367642, 500369632, 504043717, 504043883, 504088408, 504088409	V2515	-	-	-	⊖ ⊖ OE#s: 500367032, 500369633, 504043718, 504043884
01-06	65 C Series	V2518	-	-	-	⊖ ⊖ OE#s: 500377618, 504014873	V2515	-	-	-	⊖ ⊖ OE#s: 500367032, 500369633, 504043718, 504043884
Turbo Daily											
89-99	Turbo Daily 30.10, 35.10, 35.12 Leaf spring rear (check OE numbers)	"V1102" *13 OR V1055 *13	-	-	-	⊖ ⊖ V1102 = OE#: 93826662 or V1055 = OE# 8587219	"V1103"	-	-	-	⊖ ⊖ OE # 4835372, 4835373, 4835375, 4850528
89-99	Turbo Daily 35.10, 35.12, 40.10, 40.12 Leaf spring rear. Chassis #s 5973717 -> on (Check OE numbers)	"V1102" *13 OR V1055 *13	-	-	-	⊖ ⊖ V1102 = OE#: 93826662 or V1055 = OE# 8587219	V2110	-	-	-	⊖ ⊖ 30mm shorter than V1103 OE#: 93826664, 98449030
89-99	Turbo Daily 45.10, 45.12, 49.10, 49.12 (Check OE numbers)	V1055	-	-	-	⊖ ⊖ OE#: 8587219	"V1103" *13 OR V2515 *13	-	-	-	⊖ ⊖ V1103 = OE#s: 4835372, 4835373, 4835375, 4850528 or V2515 = OE#s 4854829, 9382663
90-99	Turbo Daily 59.12	"V1172"	-	-	-	⊖ ⊖ OE#: 98415332	"V2111"	-	-	-	⊖ ⊖ OE# : 98415333, 98445872, 98445873

JAGUAR incl DAIMLER											
E-PACE											
17-on	E-Pace crossover SUV 2.0 AWD (X540) 3.0 elec susp	-	-	-	-	-	-	<u>D7708S</u> !	-	-	⊥ ⊖
F-PACE											
16-on	F-Pace SUV 2.0, 3.0 5.0 SVR AWD (X761) 5.0 elec susp	-	-	-	-	-	-	!	-	-	-
F-TYPE											
13-on	F-Type Coupe & Cabriolet 2.0, 3.0 & 5.0 5.0 SVR (X152)	-	-	-	-	-	-	-	-	-	-
I-PACE											
18-on	I-Pace SUV Electric (X590)	-	-	-	-	-	-	-	-	-	-
S-TYPE											
99-08	S-Type (X200) 5.0 elec susp	-	376076SP	-	/ MK431	⊥ ⊖	-	376073SP !	-	/ MK431	⊥ ⊖
X-TYPE											
02-09	X-Type (X400) 5.0 R	-	742025SP	-	/ "MK432"	⊥	-	-	-	-	○ ○
XE TYPE											
15-23	XE Sedan 2.0, 3.0 (X760)	-	-	-	-	-	-	-	-	-	-
XF Series											
08-Jan16	XF Sedan 2.0, 3.0, 4.2, 5.0, 2.2D, 2.7D, 3.0D (XFR) (X250)	-	-	-	-	-	-	-	-	-	-
Feb16-23	XF Sedan 2.0, 3.0 (Sport susp) (X260)	-	-	-	-	-	-	-	-	-	-
XJ Series											
69-86 (XJ12 till 93)	XJ6 & XJ 12 (incl 4.2 & 2.8 & Daimler double six up to '93)	43027	-	-	-	⊥ ⊖	43013 (x4)	-	-	-	⊖ ⊖ Takes 4 shocks on rear

Key	
*	See important installation information on inside front cover
!	Excluding self-levelling suspension
"..."	Special order - phone 010 900 1850. 6-12 week waiting period

~	Imported
#	Internal bump stop
⊖	Steering damper

- It is recommended that all new shock absorbers are fitted in pairs
- Do not mix gas and non-gas units on the same axle
- **Bold** part numbers indicate heavy-duty shocks
- Underlined part numbers indicate parts not immediately available
- *Italic* part numbers followed by > indicate parts to be discontinued

Passenger and light commercial

Part number [alphabetical listing]



Year	Application	Front					Rear				
		Entry shocks	Premium shocks	Springs	Protection kits/ Mounting kits	Mounting information	Entry shocks	Premium shocks	Springs	Protection kits/ Mounting kits	Mounting information
JAGUAR Incl DAIMLER continued											
XJ Series continued											
86-End 94	XJ6, XJ12 Daimler Sovereign & Double Six (XJ40 Series)	"43067"	-	-	-	⊥ ⊗ bottom U bracket	"G55008" !	-	-	-	⊥ ⊕ S/pan unit
Early 94- End 94	XJ12, Daimler Double six (XJ40 Series)	"43067"	-	-	-	⊥ ⊗ bottom U bracket Chassis #s: 696459 -> on	-	-	-	-	⊥ ⊗
End 94-09	XJ6, XJ12, Daimler & Double six (X300 Series) EXD XJR	"G43147"	-	-	-	⊥ ⊗ Bottom U bracket EXD eye mountings)	"G55026" !	-	-	-	⊥ ⊗
97-03	XJ8 (X308 series) 2+2	-	-	-	-	⊥ ⊕	"G55026" !	-	-	-	⊥ ⊕
10-12	XJ 3.0, 5.0 (X351 series)	-	-	-	-	⊥ ⊕	-	-	-	-	⊥ ⊕
XJS											
75-96	XJS & XJSC	43027	-	-	-	⊥ ⊕	43013 (x4)	-	-	-	⊕ ⊕ Takes 4 shocks on rear

JEEP

For Jeep CJ ... see Willys at the end of the alphabetical section, after Volvo

Jeep Cherokee / Liberty

91-01	Jeep Cherokee 4x4 MM Sport, Limited & Country (XJ) Std ht	37083	RS999128 (Std ht)	-	-	⊥ ⊕	37027	"RS999129" (Std ht)	-	-	⊕ ⊕
	RAISED - 63.5mm (2.5") Lift		RS999239 (Raised 63.5mm)								
02-07	Jeep Cherokee 4x4 (KJ)	71577ST	RS999764 >*		MK = 905902MM (right) & 905903MM (left)	⊕ * R999764 adj knob needs to be removed and replaced after shock fitment.	37203	RS999284 >*	-	-	⊕ ⊕ * RS999284 adj knob needs to be removed and replaced after shock fitment.
08-13	Jeep Cherokee 4x4 (KK)	71577ST	RS999764 >*		MK = 905902MM (right) & 905903MM (left)	⊕ * R999764 adj knob needs to be removed and replaced after shock fitment.	37203	RS999284 >*	-	-	⊕ ⊕ * RS999284 adj knob needs to be removed and replaced after shock fitment.
14-21	Jeep Cherokee 4x2 EXD Trailhawk (KL)	"14-18 = 72930ST R > 72931ST L > and "19-21 = "72127ST" R > "72128ST" L >	-	-	-	⊕ 72930ST / 31ST requires retainer 9021154	37358ST >	-	-	-	⊥ ⊕ No dustcover
14-21	Jeep Cherokee 4x4 MM Trailhawk (KL)	"73125ST" R > "73126ST" L >	-	-	-	⊕	"37395ST" >	-	-	-	⊥ ⊕ No dustcover

Jeep Commander

07-09	Commander 3.0, 4.7 & 5.6 (XK)	-	71377ST	-	-	⊕	-	911278MM	-	-	⊕ ⊕
-------	-------------------------------	---	---------	---	---	---	---	----------	---	---	-----

Jeep Compass

07-10	Compass (MK) gen1	-	72367ST R 72368ST L	-	MK = 907994MM	⊕	-	72401ST	-	MK = 906959MM	⊕
11-16	Compass (MK2) gen 1 Facelift	-	72950ST R 72951ST L	-	MK = 907994MM	⊕	-	72952ST	-	MK = 906959MM	⊕

Gladiator

22-on	Jeep Gladiator pickup (LN) Std Height	"37380ST"	RS999063	-	-	⊕ ⊕	"37416ST"	-	-	-	⊕ ⊕
-------	---------------------------------------	-----------	----------	---	---	-----	-----------	---	---	---	-----

Jeep Grand Cherokee

93-98	Jeep Grand Cherokee All (ZJ series) (MM) Up Country Susp) Std Height	D4001 > 37081	RS999128 (std height)	-	-	⊥ ⊕	D4002 > 37082	-	-	-	⊕ ⊕
	Raised 76mm		RS999239 (raised 76mm)	-	-		-	"RS999194" > (Raised 76mm)	-	-	
	Steering Damper ⊕	SC2928 ⊕				⊕ ⊕					

Key

*	See important installation information on inside front cover
!	Excluding self-leveling suspension
"..."	Special order - phone 010 900 1850. 6-12 week waiting period

~	Imported
#	Internal bump stop
⊕	Steering damper

- It is recommended that all new shock absorbers are fitted in pairs
- Do not mix gas and non-gas units on the same axle
- **Bold** part numbers indicate heavy-duty shocks
- Underlined part numbers indicate parts not immediately available
- *Italic* part numbers followed by > indicate parts to be discontinued

Passenger and light commercial

Part number [alphabetical listing]

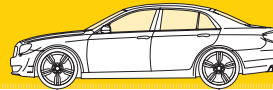

Year	Application	Front					Rear				
		Entry shocks	Premium shocks	Springs	Protection kits/ Mounting kits	Mounting information	Entry shocks	Premium shocks	Springs	Protection kits/ Mounting kits	Mounting information
JEEP continued											
Jeep Grand Cherokee continued											
99-5/05	Jeep Grand Cherokee All (WJ series) EXCL Up Country susp) Std Height	911522MM > 37161	RS999128 (std height)	-		⊥ ⊕	911523MM > 37162	-	-		⊕ ⊕
	Raised 45mm		RS999239 (50mm longer)	-			-	RS999284 > (14mm longer)	-		561mm Open length
	Steering Damper ⊕	SC2962 ⊕			SA1999 S/D Protective boot	⊕ ⊕	-				
6/05-2/11	Jeep Grand Cherokee All (WK series) EXCL up country / raised susp) EXCL SRT8	-	71377ST	-		⚙	911278MM	-	-		⊕ ⊕
			72546ST ('11-'15 EXCL stabiliser bar bracket) / 73077ST R / 73078ST L ('16-'21 EXCL stabiliser bar bracket)	-		⊥ ⊗ (U brkt) S/pan unit Square headlights (check if stabi bar or not)	911304MM !	-	-		⊥ ⊗ (Btm U bracket)
22-on	Jeep Grand Cherokee All (WL series) EXCL : Air susp, elec or self-leveling susp.	-		-			!	-	-		
Jeep Patriot											
07-10	Patriot 4x4 (MK)	-	72367ST R 72368ST L	-	MK = 907994MM	⚙	-	72401ST	-	MK = 906959MM	⚙
11-18	Patriot (MK2) (Facelift)	-	72950ST R 72951ST L	-	MK = 907994MM	⚙	-	72952ST	-	MK = 906959MM	⚙
Jeep Renegade											
15-on	Jeep Renegade (BU) SUV 4x2	-	742290SP R 742291SP L	-	PK426 /	⚙	-	742292SP R 742293SP L	-	PK427 /	⚙
15-on	Jeep Renegade (BU) SUV 4x4	-	742296SP R 742297SP L	-	PK426 /	⚙	-	742294SP R 742295SP L	-	PK427 /	⚙
Jeep Wrangler											
86-96	Jeep Wrangler 4x4 (YJ series) Std Height	"37120"	"RS999168" > (std height)	-		⊥ ⊕	"37121"	RS999113 (std height)	-		⊕ ⊕
	Raised 63mm		"RS999168" > (raised 63mm)	-			-	"RS999118" > (raised 63mm)	-		
	Steering Damper ⊕	SC2928 ⊕			SA1999 S/D Protective boot	⊕ ⊕					
97-06	Jeep Wrangler 4x4 (TJ series) EXCL Sport (Sport Rubicon) std height	37026	RS999128 (std height)	-		⊥ ⊕	37135	RS999240 > (std height)	-		⊕ ⊕
	Raised 63mm		RS999239 (Raised 63mm)	-		63mm lift kits: "RS6503B" (Sport system)	-	RS999241 (Raised 63mm)	-		63mm lift kits: "RS6503B" (Sport system)
	Steering Damper ⊕	SC2928 ⊕			SA1999 S/D Protective boot	⊕ ⊕	-	-			
07-18	Jeep Wrangler 4x4 (JK series) 2 & 4 door EXCL Rubicon & Unlimited Std Height	911536MM	RS999326 (std height)	-		⊥ ⊕	911538MM	RS999328 (Std height)	-		⊕ ⊕
	Raised 50mm	-	RS999326 (Raised 50mm)	-			-	-			
	Steering Damper ⊕	SC2970 ⊕			SA1999 S/D Protective boot	⊕ ⊕ (Only for OE #'s 52060058AE & 52060058AF)	-	-			
18-on	Jeep Wrangler (JL series) Std Height	"37380ST"	RS999063			⊕ ⊕	"37381ST"	RS999064			⊕ ⊕
	Steering Damper ⊕	"SC2974" ⊕				⊕ ⊕					⊕ ⊕

Key	
*	See important installation information on inside front cover
!	Excluding self-levelling suspension
"..."	Special order - phone 010 900 1850. 6-12 week waiting period

~	Imported
#	Internal bump stop
⊕	Steering damper

- It is recommended that all new shock absorbers are fitted in pairs
- Do not mix gas and non-gas units on the same axle
- **Bold** part numbers indicate heavy-duty shocks
- Underlined part numbers indicate parts not immediately available
- *Italic* part numbers followed by > indicate parts to be discontinued

Passenger and light commercial

Part number [alphabetical listing]

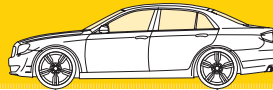

Year	Application	Front					Rear				
		Entry shocks	Premium shocks	Springs	Protection kits/ Mounting kits	Mounting information	Entry shocks	Premium shocks	Springs	Protection kits/ Mounting kits	Mounting information
JMC (Jiangling Motors Corporation)											
Boarding Pick-up											
10-16	Boarding Pick-up 4x2	GT2030 / M8058	-	-	-	⊥ ⊕	GT2044 / M6902	-	-	-	⊕ ⊕
10-16	Boarding Pick-up 4x4	GT2030 / M8058	-	-	-	⊥ ⊕	GT2044 / M6902	-	-	-	⊕ ⊕
Landwind											
15-on	Landwind 5 SUV		-	-	-			-	-	-	
Star (Changan)											
15-on	Star III pickup		-	-	-			-	-	-	
Vigus Pick-up											
14-19	Vigus Pick-up		-	-	-			-	-	-	
19-on	Vigus 5 Pick-up		-	-	-			-	-	-	
JINBEI											
H2											
15-on	H2L minibus taxi	M8047 / GT2094	-	-	-	⊥ ⊕	M8074 / GT2102	-	-	-	⊙ ⊙
KIA											
Carens / Rondo											
00-05	Carens MPV (FC / RS)	-	-	-	-	⊕	"G16331" R "G16332" L	-	-	-	⊕ (For 30mm hub only)
06-12	Carens MPV (UN)	-	"71135ST" R "71136ST" L	-	MK001	⊕	G1094	-	-	-	⊥ ⊗
Carnival											
99-04	Carnival MPV (KV-II / UP) gen 1	-	<i>72170ST</i> R > <i>72171ST</i> L > <i>68401</i> R > <i>68402</i> L >	-	-	⊕	<i>G21663</i> >	-	-	-	⊥ ⊙
See Kia Sedona for models 2005-2020											
21-on	Carnival / Grand Carnival MPV (KA4) gen 4	-		-	-			-	-	-	
Cee'd											
09-12	Cee'd hatch 2.0 3-door (ED)	"G8165" R "G8166" L	-	-	"PK299" / MK332 or MK001 (bearing only)	⊕	G1094	-	-	PK300	⊥ ⊗
Cerato / Spectra / Forte											
04-July'09	Cerato / Spectra 1.6 & 2.0, (LD) gen 1	"G7314" R "G7315" L	-	-	-	⊕	"G7312" R "G7313" L	-	-	-	⊕
Aug'09-13	Cerato / Forte sedan, hatch & Koup (TD) gen 2	G7384 R G7385 L	-	-	-	⊕	G2222	-	-	-	⊙ ⊙
13-18	Cerato / Forte sedan, hatch & Koup (YD) gen 2		-	-	MK475	OE# 54651A7100 / 54651A7400	G2229	<i>5671ST</i> >	-	-	⊕ ⊕ OE# 55300A7100
Cerato Koup											
10-13	Cerato Koup 2.0 Coupe (TD)	G7384 R G7385 L	-	-	-	⊕	G2222	-	-	-	⊙ ⊙
14-18	Cerato Koup 1.6T Coupe (YD)		-	-	MK475		G2229	-	-	-	⊕ ⊕
Ceres											
98-01	Ceres dropside LDV gen 3	M5468 / GT2023	-	-	-	⊥ ⊕	M4441 / GT2044	-	-	-	⊕ ⊕ 16 ID bushings
K2500 & K2700											
01-04	K2700 LDV gen 3	M5468 / GT2023	-	-	-	⊥ ⊕	M4441 / GT2044	-	-	-	⊕ ⊕ 16 ID bushings

Key

*	See important installation information on inside front cover
!	Excluding self-levelling suspension
...	Special order - phone 010 900 1850. 6-12 week waiting period

~	Imported
#	Internal bump stop
⊕	Steering damper

- It is recommended that all new shock absorbers are fitted in pairs
- Do not mix gas and non-gas units on the same axle
- **Bold** part numbers indicate heavy-duty shocks
- Underlined part numbers indicate parts not immediately available
- *Italic* part numbers followed by > indicate parts to be discontinued

Passenger and light commercial

Part number [alphabetical listing]

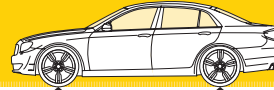

Year	Application	Front					Rear				
		Entry shocks	Premium shocks	Springs	Protection kits/ Mounting kits	Mounting information	Entry shocks	Premium shocks	Springs	Protection kits/ Mounting kits	Mounting information
KIA continued											
K2500 & K2700 continued											
end 04-14	K2700 1.3 ton & K2500 1.0 ton LDV gen 4	M5468 / GT2023	–	–	–	⊥ ⊕ (check bottom mounting)	GT2109	–	–	–	⊕ ⊕ 20 ID bushings
end 14-on	K2700 1.3 ton & K2500 1.0 ton LDV gen 4 facelift	D7705S	–	–	–	⊥ ⊕ (check bottom mounting) OE# 543004E100	GT2109	–	–	–	⊕ ⊕ OE# 553004E400
Magentis											
04-05	Magentis 2.0, 2.5 V6 (MS)	–	"71417" >	–	–	⊕	–	"71326"	–	–	⊥ ⊕
Optima / K5											
11-14	Optima 2.4 sedan (TF)	–	–	–	–	⊕	–	5646ST	–	–	⊥ ⊗ Bottom U bracket
Picanto											
04-June '11	Picanto 1.0, 1.1 Hatch (SA / BA) gen 1	G7025 / G7026	–	"SP3552" diesel	PK337 / MK469 bearings)	⊕	G1102	–	"SP3553" diesel	PK298	⊥ ⊕
July '11-June '17	Picanto 1.0, 1.2 Hatch (TA) gen 2	G7106 / G7107	–	SP4036 (July '11-April '13) / SP4037 May '13 - June '17	PK337 / MK460 bearings) + MK405 (bearing only)	⊕	G1102	–	SP4038	PK298	⊥ ⊕
July 17-on	Picanto 1.0, 1.2 Hatch (JA) gen 3	–	–	–	/ MK479 bearings)	–	G1102	–	PK298 /	–	⊥ ⊕
Pegas											
21-on	Pegas sedan 1.4 (AB)	–	–	–	–	–	–	–	–	–	–
Pregio											
01-04 RSA ('95-06 internationally)	Pregio 12 seater minibus	M5468 / GT2023	–	–	–	⊥ ⊕ Bottom Cross Stem models only (No s/pan or bottom eye models)	911536MM	–	–	–	⊥ ⊕ Check dimensions before ordering: Compr 356mm, Ext 557mm, btm eye ID 12mm
Pride											
97-00	Pride	"R11357" / "R11358"	–	–	–	⊕	"R3897"	–	–	–	⊥ ⊕
For Pro Cee'd ... see Cee'd above											
Rio											
03-Feb'06	Rio 1.3, 1.5 gen 1 facelift (DC) earlier models	–	–	–	–	⊕	G1081	5799ST >	–	–	⊕ ⊕ For OE#'s 55310FD050, 55310FD051, 55310FD150, SH20004600
March'06-Oct'11	Rio 1.4, 1.6 gen 2 (JB)	–	72297ST / 72298ST	–	PK183 / MK337 bearings) OR MK001 (bearings only)	⊕	–	5621ST	–	"PK297"	⊥ ⊕
Nov'11-May 17	Rio 1.2, 1.4, 1.6 gen 3 (UB)	G7421 / G7422 OR G7419 / G7420	–	SP4039 (1.2) / SP4040 (1.4) diesel)	MK460 bearings) + MK405 (bearing only)	⊕ 1,2 & 1.4 = G7421/22 = 14mm ID camber bolt holes / 1,6 = G7419/20 12mm ID camber bolt holes	G2223	–	SP4041	PK381	⊕ ⊕
June 17-on	Rio 1.2, 1.4 gen 3 (YB)	–	–	–	–	–	G1351	–	–	–	⊥ ⊕ (no dustcover)
Sedona											
04-April'07	Sedona MPV gen 1 (GQ / KV)	"G8401" / "G8402"	72170ST > / 72171ST >	–	–	⊕	–	37272ST	–	–	⊥ ⊕

Key

*	See important installation information on inside front cover
!	Excluding self-levelling suspension
"..."	Special order – phone 010 900 1850, 6-12 week waiting period

~	Imported
#	Internal bump stop
⊕	Steering damper

- It is recommended that all new shock absorbers are fitted in pairs
- Do not mix gas and non-gas units on the same axle
- **Bold** part numbers indicate heavy-duty shocks
- Underlined part numbers indicate parts not immediately available
- *Italic* part numbers followed by > indicate parts to be discontinued

Passenger and light commercial

Part number [alphabetical listing]

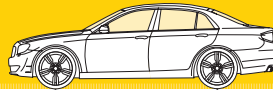

Year	Application	Front					Rear				
		Entry shocks	Premium shocks	Springs	Protection kits/ Mounting kits	Mounting information	Entry shocks	Premium shocks	Springs	Protection kits/ Mounting kits	Mounting information
KIA continued											
Sedona continued											
May '07-14	Sedona MPV gen 2 (VQ)	—	—	—	—		G2121 >	—	—	—	
15-19	Sedona / Grand Sedona MPV gen 3 (YP)	—	—	—	—		G2121 >	—	—	—	
Also see Kia Carnival											
Seltos 											
20-on	Seltos small SUV 1,6 (SP2i)	—	—	—	—	—	—	—	—	—	—
Shuma / Sephia 											
97-Jan99	Shuma I 1.5, 1.6, 1.8 (Check date / OE#) EXC! Chassis #'s FBFSR6# & FBFD6# EXC! front Stabiliser bar	"G16341" > "G16342" >	—	—	—	 No stabi bar bracket	"G16331" > "G16332" >	—	—	—	
Feb'99- mid 01	Shuma I 1.5, 1.6, 1.8 (Check dates / chassis #) With Stabiliser bar, EXC! Chassis #'s FBFSR6# & FBFD6#	—	—	—	—	 With stabi bar bracket	"G16331" > "G16332" >	—	—	—	
Mid 01-04	Shuma II 1.5, 1.6, 1.8 (Check dates / OE # / Chassis #)	—	"72371ST" > "72372ST" >	—	—		—	"72373ST" > "72374ST2" >	—	—	 OE#s: OK2SA28700A or OK2SB28700A
Sonet 											
21-on	Sonet 1,5 crossover SUV (QY)	—	—	—	—	—	—	—	—	—	—
Sorento 											
03-06	Sorento 4x4 & 4x2 2.5 & 3.5 gen 1 (JC) EXC! elec or self-leveling susp	—	<i>D8026 ></i> D8026R / D8027L	—	PK338 / "MK216"	 S/pan unit	—	D8028S !	SP2229	"PK441" /	
07-Oct09	Sorento 4x4 & 4x2 2.5 & 3.8 gen 1(JC) EXC! elec or self-leveling susp	—	<i>D8026 ></i> D8026R / D8027L	—	PK338 / "MK216"	 S/pan unit	—	37323ST !	SP2229	"PK441" /	 (Springseat)
Nov'09-'11	Sorento 4x4 & 4x2 gen 2 (XM). EXC! elec or self-leveling susp	G8406 > G8407 >	—	—	PK338 / MK495	 EXC! OE#s 546612P400 & 546512P400	G2122 !	—	—	—	 Check top mtng (ID 16mm) EXC! OE #s 553212W200 & 553102P400
12-Feb'15	Sorento 4x2 gen 2 facelift (XM). EXC! elec or self-leveling susp	G8218 > G8219 >	—	—	PK338 / MK495	 (OE#s 546612P400 or 546512P400)	G2227 !	—	—	—	 Check top mtng (top ID 18mm)
12-Feb '15	Sorento 4x4 gen 2 facelift (XM). EXC! elec or self-leveling susp	G8218 > G8219 >	—	—	PK338 / MK495	 (OE#s 546612P400 ir 546512P400)	G2228 !	—	—	—	 Check top mtng (top ID 18mm)
March '15-20	Sorento 4x4 & 4x2 gen 3 (UM)	—	—	—	—	—	—	—	—	—	
March '21-on	Sorento 4x4 & 4x2 gen 4 (MQ4) 2,2 CRD	—	—	—	—	—	—	—	—	—	
Soul 											
09-14	Soul hatch 1.6 (AM)	—	72968ST > 72969ST >	—	—		—	5657ST	—	—	
End 14-19	Soul hatch 1.6, 2.0 (PS)	—	—	—	—	—	—	—	—	—	 (No dust cover)
20-22	Soul hatch 1.6, 2.0 (SK3)	—	—	—	/"MK514"	—	—	—	—	—	
Spectra 											
01-02	Spectra 1.6	—	"72371ST" > "72372ST" >	—	—	 OE#s: OK2SA34700, OK2SB34700, OK2SA34900, OK2SB34900	—	"72373ST" > "72374ST2" >	—	—	 OE#s: OK2SA28700A, OK2SB28700A

Key

*	See important installation information on inside front cover
!	Excluding self-leveling suspension
"..."	Special order - phone 010 900 1850. 6-12 week waiting period

~	Imported
#	Internal bump stop
	Steering damper

- It is recommended that all new shock absorbers are fitted in pairs
- Do not mix gas and non-gas units on the same axle
- **Bold** part numbers indicate heavy-duty shocks
- Underlined part numbers indicate parts not immediately available
- *Italic* part numbers followed by > indicate parts to be discontinued

Passenger and light commercial

Part number [alphabetical listing]

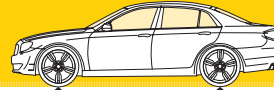

Year	Application	Front					Rear				
		Entry shocks	Premium shocks	Springs	Protection kits/ Mounting kits	Mounting information	Entry shocks	Premium shocks	Springs	Protection kits/ Mounting kits	Mounting information
KIA continued											
Sportage											
95-Sept'99	Sportage 4x4 & 4x2 Gen 1 (NB7 / FM)	—	<i>D7841</i> > <i>D7841S</i>	—	MK217	⊥ ⊗	—	<i>D7699</i> >	—	—	⊥ ⊕
Sept'99- Oct'04	Sportage 4x4 & 4x2 Gen 1 (NB7 / FM)	—	<i>D7007</i> > <i>D7007 R</i> <i>D7008 L</i>	—	—	⊥ ⊕	—	<i>D7004S</i>	—	—	⊥ ⊕
Oct'04- Sept'10	Sportage 4x4 & 4x2 Gen 2 (JE / KM)	—	<i>72219ST R</i> <i>72220ST L</i>	SP3532 (<i>3XL</i> 4x2 & 2.0 petrol)	PK160 / MK213	⊥ ⊕	—	<i>72221 R</i> <i>72222 L</i>	SP3533 (<i>3XL</i> 4x2)	PK160 / MK211R & MK212L	⊥ ⊕
Sept'10- March '16	Sportage 4x2 2.0, 2.4 Gen 3 (SL)	<i>G8176 R</i> <i>G8177 L</i>	—	SP3936 (<i>3XL</i> CRDi) OR SP3937 (CRDi only)	PK368 / MK408A (<i>3XL</i> bearings)	⊥ ⊕	<i>G1148</i> > <i>G1148A</i>	—	SP3934	/ MK512	⊥ ⊗ (Bottom U bracket)
Sept'10- March '16	Sportage 4x4 2.0, 2.4 Gen 3 (SL)	<i>G8176 R</i> <i>G8177 L</i>	—	SP3937	PK368 / MK408A (<i>3XL</i> bearings)	⊥ ⊕	<i>G1151A</i>	—	SP3935	/ MK512	⊥ ⊕
April '16- Sept 22	Sportage 4x2 1.66di Gen 4 (QL)	—	<i>742281SP R</i> <i>742282SP L</i>	—	/ MK483 (<i>3XL</i> bearings)	⊥ ⊕	—	<i>376252SP</i>	—	/ MK455 (<i>3XL</i> bearings)	⊥ ⊕
April '16- Sept 22	Sportage 4x4 2.0, 2.4 Gen 4 (QL)	—	—	—	/ MK483 <i>3XL</i> 2.4 (<i>3XL</i> bearings)	⊥ ⊕	—	<i>376252SP</i>	—	/ MK455 (<i>3XL</i> bearings)	⊥ ⊕
Oct 22-on	Sportage 4x2 1.6T Gen 5 (NQ5)	—	—	—	—	—	—	—	—	—	—

LADA

Niva

'78-'12	Niva 4x4	M8046	—	—	—	⊥ ⊕	M8038	—	—	—	⊕ ⊕
---------	----------	-------	---	---	---	-----	-------	---	---	---	-----

LANCIA

LANCIA models such as Thema, Dedra, Delta, Kappa, Lybra etc. are available as special order parts

LAND ROVER

Defender

54-83	86", 88" & 107" SWB (Series I, II, IIA, IIB & III)	M8036	"D6415S"	—	—	○ ○	—	"D4044" > "D4044S"	—	—	○ ○
	Steering Damper ⊕	<i>R2716</i> > "R3256" ⊕	—	—	—	⊥ T	—	—	—	—	—
58-84	109" & 119" LWB (<i>3XL</i> S/Wagon) Series II, IIA, IIB&III	M8036	"D6415S"	—	—	○ ○	<i>M8037</i> >	"D6615S"	—	—	○ T
	Steering Damper ⊕	<i>R2716</i> > "R3256" ⊕	—	—	—	⊥ T	—	—	—	—	—
84-16	90, 110 Defender SW & 130" Double Cab LDV (L316 & L317)	M6628	RS999339 / "D6628S"	<i>SP1734 R</i> > <i>SP2959 L</i> > H/Duty <i>3XL</i> '90	—	⊥ T	M6629	RS999340 / "D6629S" > "D6629S"	<i>SP3271 R</i> > <i>SP3272 L</i> > H/Duty <i>3XL</i> '90	—	⊕ T
20-on	New Defender (L663)	—	—	—	—	—	—	—	—	—	—

Discovery

89-94	Discovery I	M6628	"D6419" > "D6419S"	—	—	⊥ T	M6629	RS999340 / "D6440S"	—	—	⊕ T
	Steering Damper ⊕	<i>R2716</i> > "R3256" ⊕	—	—	—	⊥ T	—	—	—	—	—
95-98	Discovery I	—	RS999339	—	—	⊥ T	—	RS999340	—	—	⊕ T
	Steering Damper ⊕	<i>R2716</i> > "R3256" ⊕	—	—	—	⊥ T	—	—	—	—	—
99-end 04	Discovery 2 <i>3XL</i> Active ride control (L318)	AU160460	"RS999360"	—	—	⊕ ⊕	AU160461	<i>RS999361</i> >	—	—	⊕ ⊕

Key

*	See important installation information on inside front cover
!	Excluding self-leveling suspension
"..."	Special order – phone 010 900 1850. 6-12 week waiting period

~	Imported
#	Internal bump stop
⊕	Steering damper

- It is recommended that all new shock absorbers are fitted in pairs
- Do not mix gas and non-gas units on the same axle
- **Bold** part numbers indicate heavy-duty shocks
- Underlined part numbers indicate parts not immediately available
- *Italic* part numbers followed by > indicate parts to be discontinued

Passenger and light commercial

Part number [alphabetical listing]

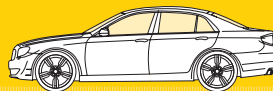

Year	Application	Front					Rear				
		Entry shocks	Premium shocks	Springs	Protection kits/ Mounting kits	Mounting information	Entry shocks	Premium shocks	Springs	Protection kits/ Mounting kits	Mounting information
LAND ROVER continued											
Discovery continued											
end 04-June 17	Discovery 3 & 4 Air susp (L319)	-	D8976S	-	AK247 (Replacement kit required when replacing the airsprings)	⊥ ⊕ S/pan unit	-	D8977S	-	AK247 (Replacement kit required when replacing the airsprings)	⊥ ⊕ S/pan unit
July 17-on	Discovery 5 Air susp (L462) gen 3 EXCL elec susp	-	-	-			-	-!	-		
<p>AK 247</p> <p>Replacement kit when exchanging the air spring on the shock absorber.</p>											
Discovery Sport											
2015-Feb 2020	Discovery Sport SUV EXCL facelift (L550) EXCL elec susp	-	<u>D0418R</u> / <u>D0419L</u>	-	/MK323 (EXCL bearings)	⊥ ⊕	-	<u>D7708S</u> !	-	-	⊥ ⊕
	Evoque - See Range Rover Evoque										
Freelander I											
98-'01	Freelander 1.8 & 2.0D EXCL 2.5 V6 (L314)	-	<u>D0003</u> > <u>D0003R</u> / <u>D0004L</u>	1.8 = "SP2963" / 2.0Tdi = "SP3275"	PK381 / MK312	⊥ ⊕	-	<u>D0005R</u> / <u>D0006L</u>	3 door = "SP2967" / 5 door = "SP3276"	PK389 / MK310	⊥ ⊕
01-March '07	Freelander All EXCL 2.5 V6 (L314)	-	<u>D0401R</u> / <u>D0402L</u>	"SP2940"	PK381 / MK312	⊥ ⊕	-	<u>D0005R</u> / <u>D0006L</u>	3 door = "SP2967" / 5 door = "SP3276"	PK389 / MK310	⊥ ⊕
Freelander II											
April '07-15	Freelander II (L359)	-	<u>D0416R</u> / <u>D0417L</u>	"SP4100"	-	⊥ ⊕	-	<u>D0422R</u> / <u>D0423L</u>	"SP4101"	-	⊥ ⊕
Range Rover											
76-96	Range Rover Classic gen 1 (EXCL Air Susp.)	M6628	<u>RS999339</u> / "D6419" > "D6419S"			⊥ T	M6629	<u>RS999340</u> / "D6440" > "D6440S"			⊕ T
	Steering Damper ⊕	<u>R2716</u> > "R3256" ⊕				⊥ T					
92-96	Range Rover Classic gen 1 Air Susp	-	"D8641" > / <u>RS999207</u>			⊥ T	-	"D6643" >			⊥ T
	Steering Damper ⊕	<u>R2716</u> > "R3256" ⊕				⊥ T					
94-on April '02	Range Rover Pegasus gen 2 (P38A) Std & Air Susp	-	<u>RS999362</u> > / <u>D8644</u> > <u>D8644S</u>			⊕ T	-	<u>RS999363</u> > / <u>D8645</u> > <u>D8645S</u>			⊕ T
May '02-12	Range Rover gen 3 (EXCL Sport) L322	-					-	<u>D4004S</u>			⊥ ⊕
13-21	Range Rover gen 4 (EXCL Sport & SVR) L405	-					-				
22-on	Range Rover gen 5 (EXCL Sport & SVR) L460	-					-				
Range Rover Evoque											
11-May 19	Range Rover Evoque gen 1 EXCL : Elec susp & Sport (L538)	-	<u>D0418</u> > <u>D0418R</u> / <u>D0419L</u>			⊥ ⊕	-	<u>D0420R</u> / <u>D0421L</u> !			⊥ ⊕
June 19-on	Range Rover Evoque gen 2, D200 diesel & P300e hybrid EXCL : Elec susp & Sport (L551)	-			/MK323 (EXCL bearings)		-	!			

Key

*	See important installation information on inside front cover
!	Excluding self-levelling suspension
"..."	Special order - phone 010 900 1850. 6-12 week waiting period

~	Imported
#	Internal bump stop
⊕	Steering damper

- It is recommended that all new shock absorbers are fitted in pairs
- Do not mix gas and non-gas units on the same axle
- **Bold** part numbers indicate heavy-duty shocks
- Underlined part numbers indicate parts not immediately available
- *Italic* part numbers followed by > indicate parts to be discontinued

Passenger and light commercial

Part number [alphabetical listing]

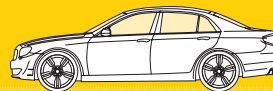

Year	Application	Front					Rear				
		Entry shocks	Premium shocks	Springs	Protection kits/ Mounting kits	Mounting information	Entry shocks	Premium shocks	Springs	Protection kits/ Mounting kits	Mounting information
LAND ROVER continued											
Range Rover Sport											
05-12	Range Rover Sport air susp gen 1 (L320)	-	D8976S	-	AK247 (Replacement kit required when replacing the airsprings)		-	D8977S	-	AK247 (Replacement kit required when replacing the airsprings)	
13-on	Range Rover Sport air susp gen 2 (L494) SVR	-		-			-	D8977S	-	AK247 (Replacement kit required when replacing the airsprings)	
<p>AK 247</p> <p>Replacement kit when exchanging the air spring on the shockabsorber.</p>											

Range Rover Velar

17-on	Range Rover Velar D300 gen 1 SVR elec susp (L560)	-		-			-		-		
-------	--	---	--	---	--	--	---	--	---	--	--

For Landwind ... see JMC

For Leyland Mini ... see Austin

LEXUS

RX

03-07	RX300 XE 3.0 V6 4x4 SVR air susp gen 2 (XU30)	-	<i>"72211ST" R ></i> <i>"72212ST" L ></i>	-			-		-		
08-09	RX350 3.5 V6 4x4 SVR air susp gen 2 facelift (XU30)	-	<i>"72211ST" R ></i> <i>"72212ST" L ></i>	-			-		-		
10-15	RX 350, 450h 4x4 SVR air susp gen 3 (AL10)	-		-			-	<i>37361ST ></i>	-		

LIFAN (Sold via CMC Calibra Motor Corp)

Amandla

12-18	Amandla 14 seater minibus taxi	M5464	-	-	-		-		-		
-------	--------------------------------	--------------	---	---	---	--	---	--	---	--	--

Sesbuyile

12-18	Sesbuyile 16 seater minibus taxi	-	-	-	-		-		-		
-------	----------------------------------	---	---	---	---	--	---	--	---	--	--

MAHINDRA

Bolero

05-15	Bolero 2.5 Td 4x2 Single & D/C LDV 4x2 (Check mountings for the correct application)	M5468	-	-	-	 EXCL models with bottom eye	M8059	-	-	-	 (16 ID mountings)
05-15	Bolero 2.5 Td 4x4 Single & D/C LDV 4x4 (Check mountings for the correct application)	M8031	-	-	-	 EXCL models with bottom cross stem	M8059	-	-	-	[For units with a top ID of 12mm, reuse the OE sleeve]
15-on	Bolero 2.5 Td Single & D/C 4x2 & 4x4 LDV	-	-	-	-		-		-		

Key

*	See important installation information on inside front cover
!	Excluding self-levelling suspension
"..."	Special order - phone 010 900 1850. 6-12 week waiting period

~	Imported
#	Internal bump stop
⊕	Steering damper

- It is recommended that all new shock absorbers are fitted in pairs
- Do not mix gas and non-gas units on the same axle
- **Bold** part numbers indicate heavy-duty shocks
- Underlined part numbers indicate parts not immediately available
- *Italic* part numbers followed by > indicate parts to be discontinued

Passenger and light commercial

Part number [alphabetical listing]

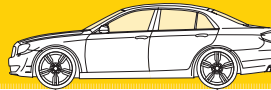

Year	Application	Front					Rear				
		Entry shocks	Premium shocks	Springs	Protection kits/ Mounting kits	Mounting information	Entry shocks	Premium shocks	Springs	Protection kits/ Mounting kits	Mounting information
MAHINDRA continued											
Genio											
11-16	Genio 2.2 4x2 1.2 ton pick-up	—	—	—	—	S/pan unit	—	—	—	—	⊖ ⊖ (OE Top mtng 18mm ID, btm 12mm ID, & length 538mm)
KUV100											
16-22	KUV100 SUV 1.2	—	—	—	—		—	—	—	—	⊥ ⊖ (Ind)
Scorpio											
05-15	Scorpio 4x2 SUV (S10) gen 1 4x2 (Check mountings for correct applications)	M8060	—	—	—	⊥ ⊖ Closed 230mm / Open 355mm	M8038 or M8089 or M8048 or M8036 (Check lengths and mountings)	—	—	—	⊖ ⊖ M8038 161D top & btm eye (closed 319mm, open 515mm) or M8089 (closed 330mm, open 534mm) NOTE: For models with 12mm top mtng – Must re-use the orig top metal sleeve or M8048 (16mm ID top & 19.5mm ID bottom eyes) Re-Use top metal sleeve from original shock OE# 0403BAA01041N or M8036 (191D rubbers top & bottom)
05-15	Scorpio 4x4 SUV (S10) gen 1 4x4 (Check mountings for correct applications)	M5464	—	—	—	⊥ ⊖ btm mtg 12mm ID Closed 246mm / Open 374mm	M8038 or M8089 or M8048 or M8036 (Check lengths and mountings)	—	—	—	
end 15- Jan '22	Scorpio 4x2 & 4x4 SUV (S11) gen 1 facelift	M8060	—	—	—	⊥ ⊖ Closed 230mm / Open 355mm	V2505 or R2775 (check mountings and lengths)	—	—	—	⊖ ⊖ V2505 = 12mm ID mtng top & btm. Closed 362mm & open 587mm ⊖ ⊖ R2775 (Ind) = 12mm ID top mtng & 16mm btm mtng ID, Closed 314mm, open 503mm OE#'s 0403BAA01161N, 0403BA0420N or 0403BAA01111N
end 22-on	Scorpio-N 4x2 & 4x4 2.2D SUV (Z101) gen 2	—	—	—	—	⊥ ⊖ (S/pan unit with twin bracket) OE#'s: 0403AAA01881N / ZN2G2520	—	—	—	—	

Key

*	See important installation information on inside front cover
!	Excluding self-levelling suspension
...	Special order – phone 010 900 1850. 6-12 week waiting period

~	Imported
#	Internal bump stop
⊖	Steering damper

- It is recommended that all new shock absorbers are fitted in pairs
- Do not mix gas and non-gas units on the same axle
- **Bold** part numbers indicate heavy-duty shocks
- Underlined part numbers indicate parts not immediately available
- *Italic* part numbers followed by > indicate parts to be discontinued

Passenger and light commercial

Part number [alphabetical listing]

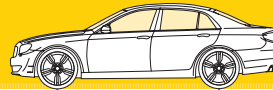

Year	Application	Front					Rear				
		Entry shocks	Premium shocks	Springs	Protection kits/ Mounting kits	Mounting information	Entry shocks	Premium shocks	Springs	Protection kits/ Mounting kits	Mounting information
MAHINDRA <i>continued</i>											
Scorpio / Pik-Up											
06-15	Scorpio Pik-Up Single & D/C 4x2 & 4x4 LDV gen 1	M5464	-	-	-	⊥ ⊕	M8059	-	-	-	M8059 = ⊕ ⊙ 16ID top & btm mtng
16-on	Pik-Up S10 Single & D/C 4x2 & 4x4 LDV gen 1 facelift [EXC] raised models	M5464 [EXC] models with s/pan	-	-	-	⊥ ⊕ (M5464 no s/pan) [EXC] OE # 0603AAA01921 with s/pan	G2238 OR V1191 (Check mountings and lengths)	-	-	-	G2238 = ⊕ ⊕ 12mm ID mtng top & btm. Closed 311mm & open 490mm OR V1191 = ⊕ ⊕ 16mm ID mtng top & btm. Closed 320mm & open 508mm
Thar											
11-20	Thar jeep	-	-	-	-		-	-	-	-	
TUV 300											
18-20	TUV 300 SUV 1.5CRD	-	-	-	-	⊕	-	-	-	-	⊙ ⊙
XUV 300											
19-on	XUV 300 SUV 1.2, 1.5D	-	-	-	-		-	-	-	-	
XUV 500											
11-18	XUV 500 SUV 2.2	G8340 R G8341 L	-	-	-	⊕	G4015	-	-	-	⊥ ⊕ S/pan unit
18-21	XUV 500 SUV facelift	-	-	-	-	⊕	-	-	-	-	⊥ ⊕ S/pan unit
XUV 700											
21-on	XUV 700 SUV 2.0T	-	-	-	-	⊕	-	-	-	-	
Xylo											
09-12	Xylo MPV & Panel van	-	-	-	-		-	-	-	-	
12-19	Xylo MPV & Panel van	-	-	-	-		-	-	-	-	

MAZDA											
1200 / 1300											
69-74	1200 & 1300 Sedan	-	-	-	-		GT2007 >	-	-	-	⊥ T
For 121 ... see Soho											
2 (Demio-cross border)											
07-Feb'15	Mazda 2 (DE)	G7401 R G7402 L	-	"SP3789" (1.3 & 1.5 [EXC] Auto) "SP3790" (1.4 & 1.6 [EXC] all Auto)	PK291 / MK317 [EXC] bearings) OR MK485 [EXC] bearings)	⊕	44001	-	"SP3791"	PK078 / MK364	⊥ ⊙
March'15-on	Mazda 2 (DJ) 1.3, 1.5	G7942 R G7943 L	-	-	/ MK461	⊕	G1387	-	-	-	⊥ ⊕
3											
04-09	Mazda 3 gen 1 (BK) [EXC] MPS, sport susp or AWD	G8803 R G8804 L	-	SP3560 [EXC] 1.6Di turbo, 2.0, 2.0CD, 2.3, MPS)	PK156 / MK282 [EXC] bearings)	⊕	23992	-	SP3559 [EXC] 2.0CD, 2.3, MPS)	PK078 / MK394	⊥ ⊕ 51mm btm sleeve length
Mid 09-Sept'14	Mazda 3 gen 2 (BL) [EXC] MPS, sport susp or AWD	G8803 R G8804 L	-	SP3975 R SP3976 L	PK156 / MK282 [EXC] bearings)	⊕	G1167	-	SP3977 R SP3978 L	-	⊥ ⊕ 36mm btm sleeve length
Oct'14-June 19	Mazda 3 gen 3 (BM) [EXC] MPS, sport susp or AWD	-	73015ST R 73016ST L	-	/ MK461 [EXC] bearings)	⊕		5540ST	-	-	⊥ ⊕ (No dust cover)
July 19-on	Mazda 3 gen 4 (BP) 1.5 [EXC] MPS, sport susp or AWD	-	-	-	-		-	-	-	-	

Key

*	See important installation information on inside front cover
!	Excluding self-levelling suspension
"..."	Special order - phone 010 900 1850. 6-12 week waiting period

~	Imported
#	Internal bump stop
⊕	Steering damper

- It is recommended that all new shock absorbers are fitted in pairs
- Do not mix gas and non-gas units on the same axle
- **Bold** part numbers indicate heavy-duty shocks
- Underlined part numbers indicate parts not immediately available
- *Italic* part numbers followed by > indicate parts to be discontinued

Passenger and light commercial

Part number [alphabetical listing]

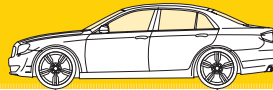

Year	Application	Front					Rear				
		Entry shocks	Premium shocks	Springs	Protection kits/ Mounting kits	Mounting information	Entry shocks	Premium shocks	Springs	Protection kits/ Mounting kits	Mounting information
MAZDA <i>continued</i>											
323											
77-78	323 (Imported Strut) R.W.D (FA 4th gen)	—	—	—			GA2077 >	—	—		
78-Mid 81	323 (Local Strut) R.W.D (FA 4th gen)	GT0402 >	—	—		Re-use OE G/Screw but remove collar from inside it first	GA2077 >	—	—		
Mid 81-85	323 F.W.D (BD 5th gen)	R11040	—	—	PK058		11261 11260	—	—	PK018	
85-91	323 (EGi) F.W.D (BF 6th gen)	GT7228	—	—	PK058	Re-Use OE B/ Hose Bracket	GT7229	—	SP0433	PK018	
92-'03	323 All Midge & Sting (BF 6th gen)	GT7251	—	—	PK058	Re-Use OE B/ Hose Bracket	GT7229	—	SP0433	PK018	
5 (Premacy)											
01-04	Premacy (Cross border) Gen 1 K	—	—	—			—	5607ST 99-01 models)	—	PK078 / MK394	
05-10	Mazda 5 MPV Gen 2 (CR19)	—	72263ST 72264ST	—	PK156 / MK282		—	5607ST	—	PK078 / MK394	
11-15	Mazda 5 MPV Gen 3 (CW)	—	72263ST 72264ST	—	PK156 / MK282		—	5607ST	—	PK078 / MK394	
6											
03-07	Mazda 6 MPS gen 1 (GG)	G23101	—	—	PK157 / "MK358" (Both 2003)		23980	—	—	—	
08-12	Mazda 6 MPS gen 2 (GH)	G1155 G1156	—	—			G1157	—	—	—	
13-16	Mazda 6 MPS gen 3 (GJ)	—	72938ST 72939ST	—	/ MK461 bearings)		—	5515ST	—	—	 no dust cover
626											
83-93	626 Sedan (Coupe) RSA mnf model	GT7216 >	—	—	"PK041" > (Boots only)		—	—	—	PK030 >	
93-Mid 99	626 Sedan All MX6 (GE)	GT8028 GT8029	—	—	"PK114"		GT8030	—	—	"MK173"	
Mid 99-03	626 sedan (GF) [assembled in Zimbabwe]	16411 16412	—	—	—		G16762 G16763	—	—	PK006	
626											
Mid 99-03	626 S/W (GW) [assembled in Zimbabwe]	16411 16412	—	—	—		—	—	—	—	
For Astina ... see Etude											
B Series											
68-85	B1500, B1600, B1800 LDV	—	—	—	—		GT2007 >	—	—	—	
B Series Magnum											
86-3/00	B Series Magnum All 4x2	GT2030 / M8058	—	—	—		GT2031 / M8059	—	—	—	
86-3/00	B Series Magnum All 4x4	M7366	RS999039 (Re-use bottom OE sleeve)	—	—		M7367	RS999321	—	—	
B Series Drifter											
4/00-07	Drifter 4x2 std ht (Hi-Trail 4x2)	GT2030 / M8058	—	—	—		GT2031 / M8059	—	—	—	
4/00-07	Drifter 4x4 & Hi-Trail 4x2	M7366	RS999039 (Re-use bottom OE sleeve)	—	—		M7367	RS999321	—	—	

Key

*	See important installation information on inside front cover
!	Excluding self-levelling suspension
...	Special order - phone 010 900 1850. 6-12 week waiting period

~	Imported
#	Internal bump stop
⊕	Steering damper

- It is recommended that all new shock absorbers are fitted in pairs
- Do not mix gas and non-gas units on the same axle
- **Bold** part numbers indicate heavy-duty shocks
- Underlined part numbers indicate parts not immediately available
- *Italic* part numbers followed by > indicate parts to be discontinued

Passenger and light commercial

Part number [alphabetical listing]

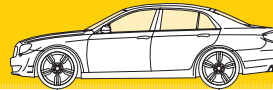

Year	Application	Front					Rear				
		Entry shocks	Premium shocks	Springs	Protection kits/ Mounting kits	Mounting information	Entry shocks	Premium shocks	Springs	Protection kits/ Mounting kits	Mounting information
MAZDA <i>continued</i>											
BT-50											
07-11	BT-50 4x2 std ht EXD Hi-Trail 4x2 gen 1 (UN)	GT2030 / M8058	-	-	-	⊥ ⊕	GT2112 / M8073	-	-	-	○ ○
07-11	BT-50 4x4 & Hi-Trail 4x2 gen 1 (UN)	M7366	RS999039 (Re-use bottom OE sleeve)	-	-	⊥ ⊕	M7367	RS999321	-	-	⊕ ⊕
12-21	BT-50 4x2 std ht EXD Hi-Trail 4x2 gen 2 (PN40, UP, UR)	M8083	-	-	-	⊥ ⊕ S/pan unit	M8085	-	-	-	⊕ ⊕
12-21	BT-50 4x4 & Hi-Trail 4x2 gen 2 (PN40, UP, UR) Std Ht	M8086	RS999778	-	-	⊥ ⊕ S/pan unit	M8087	RS55020	-	-	⊕ ⊕
	Raised		RS55778B raised 38mm	RS40004 (30mm raise)	-	(Raised 38mm - From Australia)		RS55020A raised 38mm	-	-	(Raised 38mm - From Australia)
21-on	BT-50 4x2 std ht EXD Hi-Trail 4x2 gen 3 (TF)										
21-on	BT-50 4x4 & Hi-Trail 4x2 gen 3 (TF)										
CX-3											
15-on	CX-3 SUV 2,0 (DK)	G8629 R G8630 L	-	MK461 (UNCL bearings)	-	⊥ ⊕	G1381	-	-	-	⊥ ⊕
CX-30											
20-on	CX-30 crossover SUV 2,0 (DM)	-	-	-	-		-	-	-	-	
CX-5											
12-14	CX-5 SUV gen 1 (KE)	-	72978ST R 72979ST L	MK461 (UNCL bearings)	-	⊥ ⊕	-	5530ST	-	-	⊥ ⊕ (larger btm mtg bush ID)
14-17	CX-5 SUV gen 1 facelift (KE)	-	72978ST R 72979ST L	MK461 (UNCL bearings)	-	⊥ ⊕	-	5546ST	-	-	⊥ ⊕ (smaller btm mtg bush ID)
18-Sept '21	CX-5 SUV 2,0 FWD gen 2 (KF)	-	-	-	-		-	-	-	-	
Oct '21-on	CX-5 SUV 2,0 FWD gen 2 Facelift (KF)	-	-	-	-		-	-	-	-	
CX-60											
20-on	CX-60 crossover SUV 2,5 (KH) UNCL AWD	-	-	-	-		-	-	-	-	
CX-7											
07-12	CX-7 SUV (crossover) 4x4	-	72493ST R 72494ST L	"MK439"	-	⊥ ⊕	-	37313ST	-	-	⊥ ⊕
For Drifter ... see B-Series											
E Series											
64-83	E2000 & E3000 LDV	-	-	-	-	⊥ T	GT2007 >	-	-	-	⊥ T
Etude / Astina (also known as 323 or Familia cross border)											
94-99	Etude BH / Astina BA - J55 (RSA Mnf)	GT7253 R GT7254 L	-	1.5, 1.6 & 1.8 = "SP0295"	"PK120" / "MK257"	⊥ ⊕	GT7255 R GT7256 L	-	"SP0472"	PK134 / "MK370R" & "MK371L"	⊥ ⊕
99-00	Etude (Ch # up to -> ##304194) - J39 (BJ)	G16318 R > G16319 L >	-	SP3339 EXD 2.0	"PK120" / "MK315"	⊥ ⊕ Cross Ref OE & Chassis #'s Phone 011 574-5603 No Bracket under s/pan. Only at the bottom of strut.	G16320 R G16321 L	-	SP2607	PK119	⊥ ⊕ Cross Ref OE & Chassis #'s Phone 011 574-5603. Full length 480mm Measurement taken from top of rod to base of strut

Key

*	See important installation information on inside front cover
!	Excluding self-levelling suspension
"..."	Special order - phone 010 900 1850. 6-12 week waiting period

~	Imported
#	Internal bump stop
⊕	Steering damper

- It is recommended that all new shock absorbers are fitted in pairs
- Do not mix gas and non-gas units on the same axle
- **Bold** part numbers indicate heavy-duty shocks
- Underlined part numbers indicate parts not immediately available
- *Italic* part numbers followed by > indicate parts to be discontinued

Passenger and light commercial

Part number [alphabetical listing]

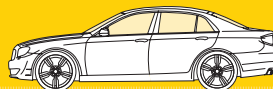

Year	Application	Front					Rear				
		Entry shocks	Premium shocks	Springs	Protection kits/ Mounting kits	Mounting information	Entry shocks	Premium shocks	Springs	Protection kits/ Mounting kits	Mounting information
MAZDA continued											
Etude / Astina continued											
00-00	Etude (Ch ##304195 up to ->##400000) - J39 (BJ)	G16345 R G16346 L	-	SP3339 (EXC1 2.0)	"PK120" / "MK315"	Cross Ref OE & Chassis #'s Phone 011 574-5603. Bracket under s/pan	G16320 R G16321 L	-	SP2607	PK119	Cross Ref OE & Chassis #'s Phone 011 574-5603. Full length 480mm Measurement taken from top of rod to base of strut
00-04	Etude (Ch #'s ##400001 - on ->) EXC1 front 2.0 26v (BJ)	G16345 R G16346 L	-	SP3339 (EXC1 2.0)	"PK120" / "MK315"	Cross Ref OE & Chassis #'s Phone 011 574-5603. Bracket under s/pan	G16347R / G16348 L	-	SP2607	PK134	Cross Ref OE & Chassis #'s Phone 011 574-5603 Full length 470mm Measurement taken from top of rod to base of strut
F Series											
68-81	F1000 & F1300 LDV	-	-	-	-		GT2007 >	-	-	-	T
For Magnum ... see B-Series											
Marathon											
91-03	Marathon 16 Seater Minibus & Panelvan	GT2023	-	-	-		GT2024	-	-	-	
MX-5											
06-15	MX-5 (Type NC)	-	"72495ST" EXC1 models with a btm U brkt)	-	-	EXC1 models with a btm U brkt)	-	"72496ST"	-	-	S/pan unit
March '15-17	MX-5 (Type ND)	-	-	-	-	-	-	-	-	-	-
MX-6											
93-Mid-99	MX-6	GT8028 R GT8029 L	-	-	"PK114"		GT8030	-	-	"MK173"	
Rustler											
87-93	Rustler LDV	GT7230	-	-	-		GT2018	-	-	-	
94-10	Rustler LDV	GT7252	-	-	PK058		GT2001	-	-	-	
Soho 121											
97-99	121 Soho gen 4 (BE, JA, JB)	GT7206	-	1.2 & 1.3 = "SE0026"	PK022 / MK055 (INC1 bearings)		GT1018	-	"SE0509"	PK018 / MK126	
99-06	121 Soho gen 4 facelift (BE, JA, JB)	GT7206	-	1.2 & 1.3 = "SE0026"	PK022 / MK055 (INC1 bearings)		GT1004 *14	-	"SE0509"	PK018 / MK126	S/pan unit (two spacer washers supplied to fit on either side of the eye mount to prevent movement)
MERCEDES-BENZ											
110 Series											
62-67	190, 200, 230 (110 Series)	R2029 ~	-	-	-		R2030 ~	-	-	-	
111 Series											
60-68	220, 250 & 280 (111 Series)	R2029 ~	-	-	-		R2030 ~	-	-	-	
114 & 115 Series											
68-77	220, 230, 240 & 280E (114, 115 Series)	"43001"	-	-	-		53005 ! ~	-	-	-	
A Class W168											
00-04	A160, A170CDi A190 (W168)	G16277	-	A160 = SP1434 > "SE1434" A170CDi = "SP1436"	MK150 (INC1 PK)		43112	-	-	-	

Key

*	See important installation information on inside front cover
!	Excluding self-levelling suspension
...	Special order - phone 010 900 1850. 6-12 week waiting period

~	Imported
#	Internal bump stop
	Steering damper

- It is recommended that all new shock absorbers are fitted in pairs
- Do not mix gas and non-gas units on the same axle
- **Bold** part numbers indicate heavy-duty shocks
- Underlined part numbers indicate parts not immediately available
- *Italic* part numbers followed by > indicate parts to be discontinued

Passenger and light commercial

Part number [alphabetical listing]



Year	Application	Front					Rear				
		Entry shocks	Premium shocks	Springs	Protection kits/ Mounting kits	Mounting information	Entry shocks	Premium shocks	Springs	Protection kits/ Mounting kits	Mounting information
MERCEDES-BENZ <i>continued</i>											
A Class W169											
05-12	A170, A180CDi, A200 (W169)	G8114	—	A170 & A200 Manual = SP3578 A170 & A200 Auto + A180CDi Manual = SP 3579 A180CDi Auto = SP3580	PK170 / MK378		43130	—	<u>SE3581</u>	PK406	⊥ ○
A Class W176											
12-Aug 18	A180, A200, A200d, A220d, A250 (W176) 300 AMG & Sport susp	G8274 R G8275 L	—	"SP4147" Auto / "SP4151" Manual	PK383 / MK452 EXCL bearings)		43136	—	"SP4142"	MK476 EXCL bearings)	⊥ ⊕ (No dust cover)
A Class W177											
Sept 18-on	A200, A200d, A250 (W177) EXCL : Elec susp, AMG A35 & Sport susp	—	—	—	—	—	G43161 ! (rigid axle) OR G43160 ! (multi-link axle)	—	—	—	⊥ ⊕ (No dust cover) Check lengths (drawings below) G43161 = 685mm G43160 = 620mm or check OE numbers
B Class W245											
06-March '12	B170, B200T, B200CDi (W245)	—	742024SP	B170 & B200 manual = SP3578 B170 & B200 auto = SP3579 B200CDi auto = SP3584	PK170 / MK378		43130	—	<u>SE3581</u>	PK406	⊥ ○
B Class W246											
April'12-18	B180, B200, B200d, B220d, B250 (W246)	G8274 R G8275 L	—	"SP4147" Auto / "SP4151" Manual	PK383 / MK452 EXCL bearings)		43136	—	"SP4143"	MK476 EXCL bearings)	⊥ ⊕ (No dust cover)
B Class W247											
19-on	B200, B250 (W247)	—	—	—	—	—	G43161 ! (rigid axle) OR G43160 ! (multi-link axle)	—	—	—	⊥ ⊕ (No dust cover) Check lengths (drawings below) G43161 = 685mm G43160 = 620mm or check OE numbers
C Class 190 Series W201											
83-94	190E EXCL Sportline (201 Series)	G16507	—	—	PK034 / MK063		43071	—	—	—	⊥ ⊕
C Class W202											
94-Aug'00	C180, C200, C220, C230 & C240 EXCL C250Td, C280, Sport susp & Station Wagon) (W202)	43080	—	C180, C200, C220, C230 & C240 = SP1448	—	⊥ ⊕	43081 !	—	SP1445	—	⊥ ⊕
94-Aug'00	C250td & C280 EXCL Sport susp Station wagons) (W202)	43089	—	C280 & C250td = SP1442	—	⊥ ⊕	43081 !	—	SP1445	—	⊥ ⊕
94-Aug'00	All Sport Suspension, EXCL C250td, C280 & S/W (W202)	"G43143"	—	—	—	⊥ ⊕	"G43146" !	—	—	—	⊥ ⊕
C Class W202											
94-Aug'01	Station wagon, EXCL Sport susp (W202)	43089	—	C180, C200, C220, C230 & C240 = SP1448 , & C250td, C280 = SP1442	—	⊥ ⊕	—	"376069SP" !	"SP0711"	—	⊥ ⊕

Key	
*	See important installation information on inside front cover
!	Excluding self-levelling suspension
"..."	Special order - phone 010 900 1850, 6-12 week waiting period

~	Imported
#	Internal bump stop
⊕	Steering damper

- It is recommended that all new shock absorbers are fitted in pairs
- Do not mix gas and non-gas units on the same axle
- **Bold** part numbers indicate heavy-duty shocks
- Underlined part numbers indicate parts not immediately available
- *Italic* part numbers followed by > indicate parts to be discontinued

Passenger and light commercial

Part number [alphabetical listing]

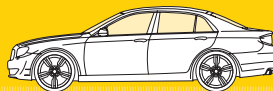

Year	Application	Front					Rear				
		Entry shocks	Premium shocks	Springs	Protection kits/ Mounting kits	Mounting information	Entry shocks	Premium shocks	Springs	Protection kits/ Mounting kits	Mounting information
MERCEDES-BENZ <i>continued</i>											
C Class W203											
Sept'00-April'07	C180, C180K, C200, C200K, C220Cdi, C230, C230K, C240, C280, C320Cdi, C350 & C270CDI (W203) Station wagon (C203) AMG, Coupe & Sports susp)	G8429	742001SP > *15	SP3314	PK339 / MK198 bearings)		43138 !	—	Sedan = SP1445 / Station Wagon = "SP3316"	—	⊥ ⊕
Sept'00-April'07	W203 Sport Suspension AMG	—	742003SP	—	PK339 / MK198 bearings)		—	376040SP !	—	⊥ ⊕	
C Class Sportcoupe CLC203											
00-11	C180K, C200K, C230K and CLC200K, CLC350 (CLC203) Sport susp & AMG	—	742002SP	"SP3318"	PK339 / MK198 bearings)		—	376045SP !	"SP3316"	⊥ ⊕	
00-11	CLC203 Sport Suspension AMG	—	742003SP	—	PK339 / MK198 bearings)		—	376040SP !	—	⊥ ⊕	
C Class W204 & S204											
5/07-May'14	C180, C200, C220Cdi, C230, C250, C250Cdi, C280, C300, C320Cdi, C350Cdi & C350 elec susp, Self level susp, AMG, Coupe, 4-Matic & Sports susp)	—	742071SP	According to OE colour paint stripes... "SP3839" 1xred + 1xyellow / "SP3839" 2xred / "SP3840" 2xyellow / "SP3841" 3xred / "SP3842" 3xyellow	PK301 / MK280 bearings)		—	376039SP !	According to OE colour paint stripes... "SP3846" 1xviolet / "SP3847" 2xviolet	PK340 / MK377 > MK377A	⊥ ⊕
5/07-May'14	W204 Elec Suspension Coupe)	—	Sedan & S/W = C2508R / C2509L	—	—	 OE# 2043230900	—	Sedan = C1510R / C1511L / S/W = "C1508R" / "C1509L"	—	⊥ ⊕	
C Class Coupe C204											
12-May'14	C Class Coupe Sport susp & AMG (Check if std or elec susp)	—	Std susp = 742071SP OR Elec susp = C2508R / C2509L	—	PK301 / MK280 bearings)	 (Check if std or elec susp)	—	!	—	⊥ ⊕	
C Class W205											
June'14-June'21	W205 C class C180, C200, C220d, C250, C250d, C300 & C350e S/Wagon, Elec susp, Self level susp, Coupe, 4-Matic, AMG & Sports susp)	—	376274SP	Diesel = "SP4283" / Petrol = "SP4281"	PK420 / MK499 bearings_	⊥ ⊗ (S/span unit with a btm U bracket)	G43155 !	376263SP > !	"SP4288"	⊥ ⊕	
June'14-June'21	W205 Elec Suspension	—	—	—	—	—	—	—	—	—	
June'14-June'21	W205 Sport Suspension S/Wagon, Elec susp, Self level susp, AMG & Coupe)	—	—	—	—	—	—	—	—	—	
C Class Coupe C205											
End'14-June'21	C Class Coupe C180, C200, C220d, C250, C250Cdi, C300, C350 Sport susp & AMG)	—	376274SP	—	PK420 / MK499 bearings_	⊥ ⊗ (S/span unit with a btm U bracket)	G43155 !	376263SP > !	—	⊥ ⊕	
C Class Cabriolet A205											
End'14-June'21	C Class Cabrio C200, C220d, C300 Sport susp & AMG)	—	376274SP	—	PK420 / MK499 bearings_	⊥ ⊗ (S/span unit with a btm U bracket)	G43155 !	376263SP > !	—	⊥ ⊕	
C Class W206											
July '21-on	W206 C class C200, C220d S/Wagon, Elec susp, Self level susp, Coupe, 4-Matic, AMG & Sports susp)	—	—	—	—	—	—	—	—	—	
July '21-on	W206 Elec Suspension	—	—	—	—	—	—	—	—	—	
July '21-on	W206 Sport Suspension S/Wagon, Elec susp, Self level susp, AMG & Coupe)	—	—	—	—	—	—	—	—	—	

For CL refer S Class coupe

Key

*	See important installation information on inside front cover
!	Excluding self-levelling suspension
"..."	Special order – phone 010 900 1850. 6-12 week waiting period

~	Imported
#	Internal bump stop
⊕	Steering damper

- It is recommended that all new shock absorbers are fitted in pairs
- Do not mix gas and non-gas units on the same axle
- **Bold** part numbers indicate heavy-duty shocks
- Underlined part numbers indicate parts not immediately available
- *Italic* part numbers followed by > indicate parts to be discontinued

Passenger and light commercial

Part number [alphabetical listing]

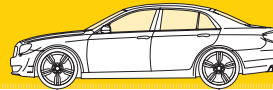

Year	Application	Front					Rear				
		Entry shocks	Premium shocks	Springs	Protection kits/ Mounting kits	Mounting information	Entry shocks	Premium shocks	Springs	Protection kits/ Mounting kits	Mounting information
MERCEDES-BENZ <i>continued</i>											
CLA C117											
13-19	CLA200, CLA200d, CLA220d, CLA250 (C117) Sport susp, Incr ground clearance, AMG & Elec susp	G8274 G8275	–	–	PK383 / MK452 bearings)	Incr ground clearance)	43136 !	–	–	–	⊥ ⊕ (No dust cover)
CLA C118											
19-on	CLA200, CLA220d, CLA250 (C118) Sport susp, AMG & Elec susp			–			G43160 !	–	–		⊥ ⊕ (No dust cover)
CLK C208 A208											
98-March '02	CLK320 & CLK430 Coupe (C208)	–	"376170SP" !	–	PK339 /	⊥ ⊕ Check OE#s	–	"376074SP" !	–	–	⊥ ⊕ Check OE#s
98-03	CLK320 & CLK430 Cabriolet (A208)	–	"376170SP" !	–	PK339 /	⊥ ⊕ Check OE#s	–	"376069SP" !	–	–	⊥ ⊕ Check OE#s
CLK C209 & A209											
April'02-09	CLK320, CLK350 & CLK500 Coupe (C209) Sport & AMG)	G8429	742001SP > *15	–	PK339 / MK198	 Check OE #s	–	376072SP !	–	–	⊥ ⊕ Check OE #s
02-09	CLK320, CLK350 & CLK500 Cabriolet (A209) Sport & AMG)	G8429	742001SP > *15	–	PK339 / MK198	 Check OE #s	43138 !	–	–	–	⊥ ⊕ Check OE #s
CLS W219											
06-July 11	CLS350 & CLS500 (W219) AMG)	–	–	–	MK325A		–	–	–	–	
CLS W218											
Aug'11-18	CLS250 CLS350d, CLS400, CLS500 (W218) AMG)	–	–	–	"PK405" / MK416 bearings)		–	–	–	"PK404"	⊥ ⊕
CLS C257											
19-22	CLS300, CLS350, CLS5400 (W257) AMG)	G43158"	–	–	"MK499"	⊥ ⊕ (S/pan unit with a btn U bracket)	"G43155"	–	–	–	⊥ ⊕
E Class W123											
77-86	W123 200, 230, 240D, 250, 280E, 300D S/W	43009 -	–	"SP0084" = 200 & 230 / "SP0150" = 250 & 280 / "SP0059" = 300D	–	⊥ ⊕	53005 ! -	–	"SP0452"	–	⊥ ⊕
E Class W124											
86-95	W124 E420, E500 all CE models C124 coupes, Self leveling susp, S/W, Sportline & V124 limo (W124)	G16507	–	200,200E, 230E & 200D = "SP0005" 260E, 280E, 300E, 250D,300D = "SP0021"	PK034 / MK063 bearings)		43071 !	–	"SP0422"	–	⊥ ⊕
E Class W124											
86-95	S124 Station wagon 230TE & 300TE sport susp	G16507	–	–	PK034 / MK063 bearings)		–	–	–	–	
E Class W210											
95-July'02	W210 E200, E240, E280, E320 & E430 Std. Susp. S/W, E230 & E270CDi, Sport & Elec susp)	43096 *15	–	E200 Classic & Elegance = "SP1440" / E240, E280, E320 Classic & Elegance = SP2621	–	⊥ ⊕	43097 !	–	E200, E240, E280, E320 Avantgarde, Classic & Elegance (Heavy Duty) = SP2617	–	⊥ ⊕
95-July'02	W210 E230 & E270CDi, Std. Susp S/W & Elec susp)	43096 *15	–	E230 Classic & Elegance = "SP1440" / E270 Classic & Elegance = "SP1439"	–	⊥ ⊕	G43140 !	–	E230, E270 Avantgarde, Classic & Elegance (Heavy Duty) = SP2617	–	⊥ ⊕

Key

*	See important installation information on inside front cover
!	Excluding self-levelling suspension
"..."	Special order – phone 010 900 1850, 6-12 week waiting period

~	Imported
#	Internal bump stop
⊕	Steering damper

- It is recommended that all new shock absorbers are fitted in pairs
- Do not mix gas and non-gas units on the same axle
- **Bold** part numbers indicate heavy-duty shocks
- Underlined part numbers indicate parts not immediately available
- *Italic* part numbers followed by > indicate parts to be discontinued

Passenger and light commercial

Part number [alphabetical listing]

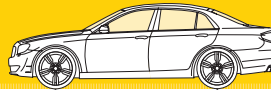

Year	Application	Front					Rear				
		Entry shocks	Premium shocks	Springs	Protection kits/ Mounting kits	Mounting information	Entry shocks	Premium shocks	Springs	Protection kits/ Mounting kits	Mounting information
MERCEDES-BENZ <i>continued</i>											
E Class T210											
96-July02	T210 Station wagon E320T, std susp	43096 *15	—	E320 Classic & Elegance = "SP1439"	—	⊥ ⊕	—	—	E320 classic & Elegance = "SP1451" (std) OR "SP3949" (self leveling)	—	—
E Class W211											
Aug'02-09	W211 E200K, E220 Cdi, E240, E270CDi, E280, E320, E350, E500, E320CDi (EXC) Station wagon, AMG & Elec & air susp)	43137	<i>376035SP</i> > *15	SP3446 (E200, E220 E270, E230, E240, E320)	"PK303" / MK325 > MK325A	⊥ ⊗	43139 ! (Std susp)	"376043SP" (Sport Susp)	SP3451 (E200, E220, E230, E240) SP3452 (E270, E280, E300, E320, E350)	—	⊥ ⊕
E Class S211											
Aug'02-mid 09	S211 Station wagon E200K, E220 Cdi, E280, E320CDi, E350, E500 (EXC) AMG & Elec & air susp)	43137	<i>376035SP</i> > *15	—	"PK303" / MK325 > MK325A	⊥ ⊗	—	"376200SP" ! (Std susp) / "376206SP" (Sport susp)	—	—	⊥ ⊕
E Class W212											
Mid 09-April '16	W212 E200, E250, E250CDi, E300, E350, E400, E500 (EXC) S/W, Coupe, Cabrio, AMG, sport susp, air susp, elec susp & AWD)	—	742129SP *15 (Std susp) / C2508R / C2509L (Elec susp)	"SP4105" (E200, E250) / "SP4106" (E300, E350)	MK416 (EXC) bearings	⊥ ⊗ (Elec OE# 2043230900)	—	376047SP !	"SP4107"	MK377 > MK377A	⊥ ⊕
E Class S212											
Mid 09-April '16	W212 Station wagon E200, E250, E300, E350, E500 (EXC) Sedan., Coupe, Cabrio, AMG, sport susp, air susp, elec susp & AWD)	—	742129SP *15 (Std susp) / C2508R / C2509L (Elec susp)	—	MK416 (EXC) bearings	⊥ ⊗ (Elec OE# 2043230900)	—	—	—	MK377 > MK377A	⊥ ⊕
E Class C207											
Mid 09-16	C207 Coupe Elec Susp (EXC) Sedan, S/W, AMG, air susp)	—	C2508R / C2509L (Elec susp)	—	MK416 (EXC) bearings	⊥ ⊗ (Elec Susp)	—	C1527R / C1528L (Elec susp)	—	—	⊥ ⊕ (Elec Susp)
E Class A207											
Mid 09-16	207 Cabriolet Elec Susp (EXC) Sedan, S/W, AMG, air susp)	—	C2508R / C2509L (Elec susp)	—	MK416 (EXC) bearings	⊥ ⊗ (Elec Susp)	—	C1529R / C1530L (Elec susp)	—	—	⊥ ⊕ (Elec Susp)
E Class W213											
May 16-April 23	W213 E200, E250, E220d, E350d, E400 (EXC) S/W, Coupe, Cabrio, AMG, sport susp, air susp, elec susp)	G43158 !	—	—	MK499 (EXC) bearings	⊥ ⊗ (S/span unit with a btm U bracket)	G43155 !	—	—	—	⊥ ⊕
E Class W214											
May 23-on	W214 E200, E220d (EXC) S/W, Coupe, Cabrio, AMG, sport susp, air susp, elec susp)	—	—	—	—	—	—	—	—	—	—
EQB											
22-on	X243 Electric SUV	—	—	—	—	—	—	—	—	—	—
EQE											
22-on	V295 Electric exec sedan	—	—	—	—	—	—	—	—	—	—
EQS											
22-on	V297 Electric sedan	—	—	—	—	—	—	—	—	—	—
22-on	Electric crossover SUV	—	—	—	—	—	—	—	—	—	—
G											
79-90	G Series Gelandewagen 4x4 (W460 / W461)	—	"D6630" > "D6630S"	—	—	⊕ ⊥	—	"D6631" > "D6631S"	—	—	⊥ ⊕
90-18	G Series Gelandewagen 4x4. (EXC) G55 AMG (W463)	—	"D6636S"	—	—	⊕ ⊥	—	"D6637S"	—	—	⊥ ⊕

Key

*	See important installation information on inside front cover
!	Excluding self-leveling suspension
"..."	Special order - phone 010 900 1850. 6-12 week waiting period

~	Imported
#	Internal bump stop
⊕	Steering damper

- It is recommended that all new shock absorbers are fitted in pairs
- Do not mix gas and non-gas units on the same axle
- **Bold** part numbers indicate heavy-duty shocks
- Underlined part numbers indicate parts not immediately available
- *Italic* part numbers followed by > indicate parts to be discontinued

Passenger and light commercial

Part number [alphabetical listing]

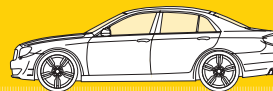

Year	Application	Front					Rear				
		Entry shocks	Premium shocks	Springs	Protection kits/ Mounting kits	Mounting information	Entry shocks	Premium shocks	Springs	Protection kits/ Mounting kits	Mounting information
MERCEDES-BENZ <i>continued</i>											
G <i>continued</i>											
18-on	G Series Geländewagen 4x4, 300 G55 AMG (W463 gen 2)	-		-	-		-		-	-	
GLA											
14-19	GLA200, GLA200d, GLA220d, GLA250, 300 elec susp & AMG gen 1 (X156)	-	742277SP R 742278SP L	-	PK383 / MK452 (300 bearings)	⊥ ⊕	43136 !	-	-		⊥ ⊕
GLA											
20-on	GLA200, GLA200d, 300 elec susp & AMG gen 2 (HZ47)			-				-			
GLB											
20-22	GLB220, GLB250 SUV (X247)										
GLC											
15-22	GLC220d, GLC250, GLC250d, GLC300, GLC350 300 Coupe, Elec susp & AMG gen 1 (X253)			-	MK499 (300 bearings)		-	376270SP !	-		⊥ ⊕
15-22	300 Coupe GLC220d, GLC250, GLC250d, GLC300, GLC350, 300 5 door, Elec susp & AMG gen 1 (C253)			-	MK499 (300 bearings)		-	376270SP !	-		⊥ ⊕
GLC											
22-on	GLC220d, GLC300 300 Coupe, Elec susp & AMG gen 2 (X254)	-		-	-		-	!	-	-	
GLE [was M Class] W166 facelift & W292											
15-19	300 (was M Class) GLE250d, GLE350d, GLE400, GLE500 4x4 (W166 facelift) 300 Coupe, AMG, Elec susp	-		-	-		-	!	-	-	
15-19	300 Coupe GLE350d, GLE500 5 door, Elec susp & AMG (C292)	-		-	-		-	!	-	-	
GLE W167											
19-on	300 GLE350d, GLE500 4x4 (W167) 300 Coupe, AMG, Elec susp, V167 LWB)	-		-	-		-	!	-	-	
GLS-Incl GL											
08-12	GL320 Cdi, GL350, GL500 4x4 300 elec susp & AMG (X164)	-		-	-		-	!	-	-	
13-19	GL350, GLS350, GL500, GLS500 4x4 300 elec susp & AMG (X166)	-		-	-		-	!	-	-	
20-23	GLS450, GLS580 4x4 300 elec susp & AMG (X167)	-		-	-		-	!	-	-	
M Class W163											
98-05	ML270CDI, ML320, ML350, ML430 & ML500 4x4 (300 ML400Cdi & ML55 AMG) (W163) 300 : AMG and Elec susp	-	D8018S	-	-	⊥ ⊕	-	D8082 > D8082S!	-	-	⊥ ⊕
M Class W164											
06-May12	M-Series ML320, ML350, ML500 4x4 (W164) (300 : AMG & Elec susp)	-		-	-	⊥ ⊕	-	D8081 > D8081S!	-	-	⊥ ⊕
M Class W166											
6/12-15	M-Series ML250, ML350, ML400, ML500 4x4 (W166) (300 : AMG, Elec susp)	-		-	-		-	!	-	-	
For newer M Class refer Mercedes GLE											
S Class 108 series											
68-73	250 & 280 All (108 Series)	R2029	-	-	-	⊥ ⊗	R2030 I	-	-	-	⊥ ○
S Class 116 series											
73-81	280S, 280E, 280SE, 350SE & 450SE 100 SEL (116 Series)	43009	-	-	-	⊥ ⊗	53005 !	-	-	-	⊥ ⊕
S Class W126											
81-93	280SE, 300SE, 380SE, 420SE, 500SE & 560SE 100 SEL & SEC (W126).	43009	-	-	-	⊥ ⊗	53005 !	-	-	-	⊥ ⊕

Key

*	See important installation information on inside front cover
!	Excluding self-levelling suspension
"..."	Special order - phone 010 900 1850. 6-12 week waiting period

-	Imported
#	Internal bump stop
⊕	Steering damper

- It is recommended that all new shock absorbers are fitted in pairs
- Do not mix gas and non-gas units on the same axle
- **Bold** part numbers indicate heavy-duty shocks
- Underlined part numbers indicate parts not immediately available
- *Italic* part numbers followed by > indicate parts to be discontinued

Passenger and light commercial

Part number [alphabetical listing]

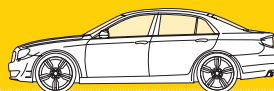

Year	Application	Front					Rear				
		Entry shocks	Premium shocks	Springs	Protection kits/ Mounting kits	Mounting information	Entry shocks	Premium shocks	Springs	Protection kits/ Mounting kits	Mounting information
MERCEDES-BENZ <i>continued</i>											
SEC C126 & C140											
81-92	380SEC, 420SEC, 500SEC, 560SEC (C126)	43009	-	-	-	⊥ ⊗	53005 !	-	-	-	⊥ ⊕
92-93	500SEC, 600SEC (C140)	"43087"	-	-	-	⊗ ⊕	!	-	-	-	
S Class W140											
93-mid99	300SE, 400SE, 500SE, (all EXC SEL) & S320, S430, S500 (W140) EXC Limo	"43087"	-	-	-	⊗ ⊕	53015 ! >	-	-	-	⊥ ⊕
93-mid99	Limo S500L & S600L (V140) + W140 S600	"43087"	-	-	-	⊗ ⊕	-	-	-	-	⊥ ⊕
S Class CL C140											
93-99	CL500, CL600 (C140) EXC elec susp	"43087"	-	-	-	⊗ ⊕	53015 ! >	-	-	-	⊥ ⊕
S Class W220											
Mid 99-07	S320, S350, S430, S500 & S320CDi (W220) EXC AMG	-	-	-	-		-	-	-	-	
S Class CL C215											
99-07	CL500, CL600 Coupe EXC CL55 & CL63 AMG (C220)	-	-	-	-		-	-	-	-	
S Class W221											
07-Sept'13	S320, S500 & S600 (W221) EXC AMG	-	-	-	-		-	-	-	-	
S Class CL C216											
07-Sept'13	CL500, CL600 EXC AMG	-	-	-	-		-	-	-	-	
S Class W222											
Oct'13-end '20	S350d, S400h, S500 & S600 (W222) EXC Coupe C217, "L" Limo V222, Maybach & AMG	-	-	-	-		-	-	-	-	
S Class C217 A217											
Oct'13-end '20	S500 (C217) (A217)	-	-	-	-		-	-	-	-	
S Class W223											
end '20-on	S350d L, S500 L (W223) EXC Limo, Maybach & AMG	-	-	-	-		-	-	-	-	
SL											
71-89	280SL & SLC, 350SL & SLC, 380SL & SLC, 450SL & SLC, 500SL EXC elec or self leveling susp (R107) (C107)	"43001"	-	-	-	⊥ ⊗	53005 !	-	-	-	⊥ ⊕
89-93	300SL & 500SL (R129) -> Chassis # F054767	-	-	-	-	⊕	-	-	-	-	⊥ ⊕
93-'9/02	SL280, SL320 & SL500 Only Chassis #: F054768 -> (EXC SL600) (R129 facelift)	"16705" !	-	-	-	⊕	-	-	-	-	⊥ ⊕
10/02-08	SL350, SL500 & SL600 (R230) EXC :AMG	-	-	-	-		-	-	-	-	
08-12	SL500 & SL600 (R230 facelift) EXC :AMG	-	-	-	-		-	-	-	-	
12-16	SL500 & SL600 (R231) EXC :AMG	-	-	-	-		-	-	-	-	
16-21	SL400 & SL500 (R231 facelift) EXC :AMG	-	-	-	-		-	-	-	-	
22-on	AMG SL43 Roadster (R232)	-	-	-	-		-	-	-	-	
SLK / SLC											
96-Mid 04	SLK200, SLK200K & SLK230K EXC SLK320 (R170)	643141	-	-	-	⊥ ⊕	643142	-	-	-	⊥ ⊕
Mid 04-July'11	SLK200K, SLK350 EXC AMG (R171)	-	-	-	-	⊕	-	376051SP	-	-	⊥ ⊕
Aug'11-20	SLK200, SLK250, SLK350 (R172) + '16-20 R172 facelift SLC200, SLC300 Electronic susp only EXC AMG)	-	"C2519R" / "C2520L"	-	-	⊕	-	"C1525R" / "C1526L"	-	-	⊥ ⊕

Key

*	See important installation information on inside front cover
!	Excluding self-leveling suspension
"..."	Special order - phone 010 900 1850. 6-12 week waiting period

~	Imported
#	Internal bump stop
⊕	Steering damper

- It is recommended that all new shock absorbers are fitted in pairs
- Do not mix gas and non-gas units on the same axle
- **Bold** part numbers indicate heavy-duty shocks
- Underlined part numbers indicate parts not immediately available
- *Italic* part numbers followed by > indicate parts to be discontinued

Passenger and light commercial

Part number [alphabetical listing]

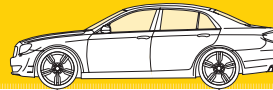

Year	Application	Front					Rear				
		Entry shocks	Premium shocks	Springs	Protection kits/ Mounting kits	Mounting information	Entry shocks	Premium shocks	Springs	Protection kits/ Mounting kits	Mounting information
MERCEDES-BENZ <i>continued</i>											
Sprinter 200, 300 & 400 Series T1N											
96-05	Sprinter van / bus. B901, B902 = 200 series, B903 = 300 series & B904 = 400 series. Gen 1 NB: Check Strut body length	V4503 (body length 319.5mm*) or	—	—	PK123 / MK277 bearings)	V4503 (Check strut body length*). OE #'s: start with 901... and 903...; plus 2D0413029 & 2D0413029B	V1116	"V1205" for models with 16" rims and heavy duty suspension (length: closed 348mm & open 546mm) OE # 9013200831	—	—	 (V1116 length: closed 319mm & open 522mm) OE# 9013200831
	NB: Check strut body length	V4507 (body length 345.5mm*)	—	—	—	V4507 (Check strut body length*). OE #'s: Start with 904... plus 2D0413029A	—	—	—	—	
* Measurement taken from centre of bottom camber bolt hole to top of strut body											
Sprinter B906 Series NCV3											
06-18	Sprinter 3 ton and 3.5 ton 4x4 gen 2 (B906)	V4510	—	—	PK302 (dust cover only) / MK287 bearings)		V1177 (for 4x4 models "V1203")	"V1202" for models with heavy duty suspension OE#'s 9063200431 & 9063201031 (length: closed 348mm & open 546mm)	—	—	 Btm eye bushing ID = 12mm, V1177 Open length mm
06-18	Sprinter 5 ton 4x4 (B906)	V4511	—	—	PK302 (dust cover only) / MK287 bearings)		V1178 OR V1188	—	—	—	 Btm eye bushing ID = 14mm Ext V1178 open length 520mm / V1188 open length 559mm
Sprinter 907 / 910 Series VS30											
19-on	Sprinter 3.5 ton 300 – 400 (VS30) AWD	—	—	—	MK287 bearings)	—	—	—	—	—	—
19-on	Sprinter 5 ton 500 (VS30) AWD	—	—	—	MK287 bearings)	—	—	—	—	—	—
Unimog Incl. military Bufel											
76-00	Unimog 403, 403, 404S, 406, 416, 416, 416	V2058 (OE# = 4043230000, 4043230100, 4063230000, 4063230200)	—	—	—	 (Eye mounting with 20 x 55mm ID. Closed length 406mm, open length 667mm)	V2058 (OE# = 4043230000, 4043230100, 4063230000, 4063230200)	—	—	—	 (Eye mounting with 20 x 55mm ID. Closed length 406mm, open length 667mm)
V Class / Viano											
06-June'10	Viano 7 seater MPV 2.2 Cdi, 3.0 Cdi, 3.5V6 air susp (W639 gen 2)	G8403	—	—	PK366	(Chassis numbers up to ->3603471)	V5007	—	SN3464	—	 OE# 6393264000
July'10-Sept'14	Viano 7 seater MPV 2.2 Cdi, 3.0 Cdi, 3.5V6 air susp (W639 gen 2 facelift) AWD	V4516	—	SE3463	PK366 / MK435 bearings)	(Chassis numbers from 3603472 ->)	V5007	—	SN3464	—	 OE# 6393264000
Oct '15-on	V Class 7 seater MPV minibus V200d, V220d, V250d, V300d (W447 Gen 3) AWD	G8819 (RWD) For AWD special order "G8821" "G8822"	—	—	MK435 bearings)		V5008 (UNCL AWD)	—	—	—	
Vito											
02-04	Vito Minibus & Van 112 & 113 FWD (W638 Gen 1)	V4301	—	—	PK006 / MK112 (UNCL bearings)	 (Monroe OE 66800)	V1501	—	—	—	 (Monroe OE 67077)

Key	
*	See important installation information on inside front cover
!	Excluding self-levelling suspension
"..."	Special order – phone 010 900 1850. 6-12 week waiting period

~	Imported
#	Internal bump stop
	Steering damper

- It is recommended that all new shock absorbers are fitted in pairs
- Do not mix gas and non-gas units on the same axle
- **Bold** part numbers indicate heavy-duty shocks
- Underlined part numbers indicate parts not immediately available
- *Italic* part numbers followed by > indicate parts to be discontinued

Passenger and light commercial

Part number [alphabetical listing]

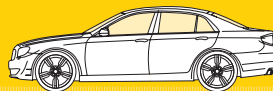

Year	Application	Front					Rear				
		Entry shocks	Premium shocks	Springs	Protection kits/ Mounting kits	Mounting information	Entry shocks	Premium shocks	Springs	Protection kits/ Mounting kits	Mounting information
MERCEDES-BENZ continued											
Vito continued											
04-Aug'10	Vito Minibus & Van 109CDi, 111CDi, 115CDi, 119, 120CDi, 122, 123, 126 (3.5) RWD incl air susp (W639 Gen 2)	G8403	—	SP3463 > SE3463 (OE: 60 red & 61 blue)	PK366	 (Chassis numbers up to ->3603471) – Do not use the older models shocks	V5007	—	SN3464	—	 (Do not use the older models shocks) 370 OE# 6393264000
Sept'10-Sept '15	Vito Van 113, 115, 116, 122 RWD incl air susp (W639 Gen 2 facelift) 370 AWD	V4516	—	SP3463 > SE3463 (OE: 60 red & 61 blue)	PK366 / MK435 370 bearings	 (Chassis numbers from 3603472 ->)	V5007	—	SN3464	—	 370 OE# 6393264000
Oct '15-on	Vito Van 111 (1.6 FWD), 114, 116, 119 (2.2 RWD) (W447 Gen 3) 370 AWD	G8819 (RWD) OR G8820 (FWD) OR for AWD special order "G8821" R "G8822" L	—	—	MK435 370 bearings		V5008	—	—	—	
X Class											
17-21	X-class LCV (Check rear suspension type before selection)	M8356	RS55787E	—	—	 S/pan unit	M8357 (for 5 link coil susp) OR M8358 (for leaf susp)	RS55194A (for 5 link coil susp)	—	—	 M8357 top mtng 16mm, btm 14mm ID / M8358 top & btm mtng both 16mm ID
MG											
95-01	MGF	"R1646A"	—	—	—		"R1647"	—	—	—	
MG ZT											
03-06	MG ZT Sports Sedan	—	—	—	—		"23945"	—	—	—	
MINI											
OLD AUSTIN MINI see "Austin"											
Mini One (New)											
01-06	Mini One, Cooper, Cooper S, One D (R50, R52, R53 Mk I)	G16493 R G16494 L	—	—	PK004 / MK197 370 bearings		23989	—	—	PK407 / MK431 370 bearings	 S/pan unit
07-13	Mini One, Cooper, Cooper D, Cooper S, One D (R56, R57 Mk II) incl cabriolet (R57) & sport	G8095 R G8096 L	<i>742049SP</i> R > <i>742050SP</i> L >	—	PK004 / MK359 370 bearings		61086	—	—	PK408 / MK431 370 bearings	 S/pan unit
14-24	Mini One, Cooper (F56 – 3 door, F55 – 5 door Mk III) incl cabriolet (F57) & sport 370 JCW GP sport	G8642 R G8643 L	—	1,2 = "SP4241" 1,5, 2.0, Cooper = "SP4242" Cabrio (F57) = "SP4243"	PK465 / MK454 370 bearings		—	<i>376268SP</i>	3 Door (F56) = "SP4244" 5 Door (F55) 370 Cooper Diesel = "SP4245" Cabrio (F57) = "SP4247"	PK466 / MK446A 370 bearings	
24-on	Mini Cooper (Mk IV)	—	—	—	—	—	—	—	—	—	—
Mini Clubman											
08-14	Mini Clubman Station Wagon incl sport (R55) mkI	G8095 R G8096 L	<i>742049SP</i> R > <i>742050SP</i> L >	—	PK004 / MK359 370 bearings		61086	—	—	PK408 / MK431 370 bearings	 S/pan unit
15-24	Mini Clubman Station Wagon incl sport (F54) mkII	G8640 R G8641 L	—	—	PK477 / MK450 370 bearings		—	<i>376269SP</i>	—	MK446A 370 bearings	
Mini Countryman											
11-16	Mini Countryman SUV Crossover incl AWD (R60) mkI	G8651 R G8652 L	—	—	PK479 / MK359 370 bearings		G7607	—	—	PK408 /	 S/pan unit
April 17-on	Mini Countryman SUV Crossover incl AWD (F60) mkII	G8640 R G8641 L	—	—	PK477 / MK450 370 bearings		—	<i>376269SP</i>	—	PK478 / MK446A 370 bearings	

Key

*	See important installation information on inside front cover
!	Excluding self-levelling suspension
"..."	Special order – phone 010 900 1850. 6-12 week waiting period

~	Imported
#	Internal bump stop
⊕	Steering damper

- It is recommended that all new shock absorbers are fitted in pairs
- Do not mix gas and non-gas units on the same axle
- **Bold** part numbers indicate heavy-duty shocks
- Underlined part numbers indicate parts not immediately available
- *Italic* part numbers followed by > indicate parts to be discontinued

Passenger and light commercial

Part number [alphabetical listing]

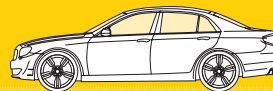

Year	Application	Front					Rear				
		Entry shocks	Premium shocks	Springs	Protection kits/ Mounting kits	Mounting information	Entry shocks	Premium shocks	Springs	Protection kits/ Mounting kits	Mounting information
MINI continued											
Mini Coupe & Roadster											
11-15	Mini Coupe (R58) & Roadster Cabriolet (R59)	-	-	-	MK359 [INCL] bearings		-	-	-	PK408 / MK431 [EXCL] bearings	
Mini Paceman											
13-16	Mini Paceman 2 door crossover (R61)	G8651 R G8652 L	-	-	PK479 / MK359 [INCL] bearings		G7607	-	-	PK408 /	\perp \oplus S/pan unit
MITSUBISHI											
ASX											
11-23	ASX SUV gen 1 (GA, W)	G8353 R G8354 L	-	-	PK342 / MK333 (incl bearings)		G1321 (with s/pan)	-	-	PK396 / MK442 [EXCL] bearings	\perp \oplus S/pan unit
Canter											
82-96	Canter (A.D.E. Engine)	M4464	-	-	-	\perp \circ	M4445	-	-	-	\circ \circ
Colt L200											
95-End 98	L200 Colt 4X2	GT2033	-	-	-	\perp \oplus	GT2034	-	-	-	\circ \circ
95-End 98	L200 Colt 4X4	M8060	-	-	-	\perp \oplus	M6902	RS999116	-	-	\circ \circ
End 98-09	L200 Colt LDV 4x2 standard height	GT2033	-	-	-	\perp \oplus	GT2031	M8059	-	-	\circ \circ (Due to the thickness of the M8059, the top of the dust cover may touch the mounting point)
End 98-08	L200 Colt LDV 4x4 [INCL] Rodeo & Pioneer 4x2 raised height & Clubcab	GT2033	-	-	-	\perp \oplus	M8052	RS999010 >	-	-	\circ \circ
Eclipse Cross											
19-on	Eclipse Cross Crossover SUV (GK, GL, YA)	-	-	-	-		-	-	-	-	
L300											
83-04	L300 LDV [EXCL] minibus	M8043 >	-	-	-	\perp \oplus	M4441	-	-	-	\circ \circ
L300 Starwagon											
82-04	L300 Van & Minibus [EXCL] LDV	M8043 >	-	-	-	\perp \oplus	GT2006	-	-	-	\circ \circ
Lancer											
01-06	Lancer 1.6 [EXCL] Evo (CS3A gen 8)	-	"72142ST"	-	"PK305"	 Large s/pan / 16" rim	-	"71379ST"	-	MK442 [EXCL] bearings	\perp \oplus S/pan unit
07-16	Lancer 1.5, 2.0 [EXCL] Evo (CY2A gen 9)	"G8137" R "G8138" L	-	-	PK342 / MK333 [INCL] bearings	 16" rim	"G1125"	-	-	"MK288"	 16" rim
Lancer Evolution X											
07-16	Lancer 2.0 Evo X (CZ4A gen 10)	-	-	-	-		-	-	-	-	
Mirage / Space Star											
14-17	Mirage 1.2 hatch gen 6 (LA)	-	-	-	-		-	-	-	-	
Outlander I											
03-May'04	Outlander 2.0, 2.4 SUV (Gen 1) CU2W, CU5W	-	72418ST	-	"PK305" / MK333 [INCL] bearings		-	-	-	"MK288"	\perp \oplus S/pan unit
June'04-May'07	Outlander 2.0, 2.4 SUV (Gen 1) CU2W, CU5W	-	72418ST	-	"PK305" / MK333		-	71147ST	-	"MK288"	\perp \oplus S/pan unit
Outlander II											
June '07-'12	Outlander 2.4 SUV (Gen 2, GS platform) CW5W [INCL] '10-'12 Facelift models	-	72437ST R 72438ST L	-	PK342 / MK333 [INCL] bearings		G1321 (with s/pan) OR 37310ST > G1455 (no s/pan)	-	-	PK396 / MK442 [EXCL] bearings	\perp \oplus Check if s/pan unit required or not

Key

*	See important installation information on inside front cover
!	Excluding self-levelling suspension
"..."	Special order - phone 010 900 1850. 6-12 week waiting period

~	Imported
#	Internal bump stop
\oplus	Steering damper

- It is recommended that all new shock absorbers are fitted in pairs
- Do not mix gas and non-gas units on the same axle
- **Bold** part numbers indicate heavy-duty shocks
- Underlined part numbers indicate parts not immediately available
- *Italic* part numbers followed by > indicate parts to be discontinued

Passenger and light commercial

Part number [alphabetical listing]

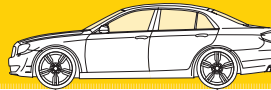

Year	Application	Front					Rear				
		Entry shocks	Premium shocks	Springs	Protection kits/ Mounting kits	Mounting information	Entry shocks	Premium shocks	Springs	Protection kits/ Mounting kits	Mounting information
MITSUBISHI continued											
Outlander III											
end '12- April '23	Outlander 2.4 SUV (Gen 3 GF/GG/ZJ/ZK) [Facelift in 2015]	G8353 R G8354 I		-	-		G1321	-	-	MK442 (R bearings)	
Outlander IV											
May '23-on	Outlander 2.4 SUV (Gen 4 GM/GN/ZM)	-		-	-		-		-	-	
Pajero / Montero / Shogun											
88-91	Pajero 4x4 gen 1 (L1466) Coil rear	AU160201 >	-	-	-		-	-	-	-	
91-99	Pajero 4x4 gen 2 V Series: V21, V24, V41, V44, V46 coil rear (NH, NJ, NK, NL) [EXCL] elec susp)	M7299	RS999223 > / "D5470S"	-	-	 No Spring seat	M7300	RS999213 > / "D5471S"	V2 2.5TD (V24C, V24W) = SP2656 & V4 & 2.8TD (V46W) = SP2654	-	 16id btm eye bushing
99-April '07	Pajero 4x4 gen3 K94W, K96W, V64W, V65W, V68W, V74W, V75W & V78W (NM, NP) [EXCL] elec susp) Check OE #'s	AU360590	RS999802	"SP3807" = 3.2 & 3.5	-	 Spring seat unit OE #s = MR448161 / MR510423 / MR554292	D7003S	RS999365	"SP3809"	-	 OE #s: MR566275 14id btm eye bushing
	Raised +-35mm		RS55802A (Raised +-38mm)			Raised 35mm		RS55365A > (raised +-38mm)			Raised 40mm
May '07-'21	Pajero 4x4 gen 4 V80 (NT / NW)	AU360590	RS999802		-	 For Rancho RS999802 use supplied isolator between spring & s/pan	D7003S	RS999365		-	
	Raised +-35mm		RS55802A (Raised +-38mm)			Raised 35mm		RS55365A > (raised +-38mm)			Raised 40mm
Pajero iO											
99-07	Pajero iO (Mini) 1.6 & 1.8 Models H66W, H67W & H77W		-	-	-		-	"D7002" > "D7002S"		-	
Pajero Sport / Montero / Challenger											
09-Aug '17	Pajero Sport SUV gen 2 (KG/KH/PB)	AU360886	-	-	-	 S/pan unit (Re-use top OE rubbers if not supplied)	AU160890	-	-	-	
Sept '17-on	Pajero Sport SUV 2.4 gen 3 (KR/KS/OE + QF facelift)	-	RS55801B	-	-	 S/pan unit	-	-	-	-	
Space Gear L400 (Cross border markets)											
95-07	Space Gear 2.4 GLX leaf rear [EXCL] coil spring susp) (L400) PA3W, PA4W, PA5W	"R3464"	-	-	-		-	-	-	-	 (Leafspring susp)
Space Runner / RVR (Cross border markets)											
91-99	Space Runner / RVR [EXCL] AWD) N11W, N18W	"16575" >	-	-	-		-	-	-	-	
99-09	Space Runner / RVR 2.0, 2.4 N63W, N64W 4x2	-	-	-	-		-	-	-	-	
For the new 3rd gen RVR see ASX											
Tredia											
83-86	Tredia Sedan [EXCL] Turbo	16508 >	-	-	-		"23442"	-	-	-	
Triton L200											
07-16	Triton LDV All 4x4 & 4x2 raised body Std height gen 4 (MN)	AU360886	-	-	-	 S/pan unit (Re-use top OE rubbers if not supplied)	M8059 / GT2031	RS999113	-	-	
	Raised Susp +-30mm	AU360845 > (20mm longer)	-	RS40016 > (20mm lift)	-	Raised 30mm	AU160844 (40mm longer)	"RS55118A" > (25mm longer)	-	-	Raised 30mm
17-24	Triton LDV All 4x4 & 4x2 raised body Std height gen 5 (MQ) [EXCL] 2019 facelift (KJ/KK/KL)	-	RS55801B (non adj)	-	-	 S/pan unit	AU160922	-	-	-	

Key

*	See important installation information on inside front cover
!	Excluding self-levelling suspension
"..."	Special order - phone 010 900 1850. 6-12 week waiting period

~	Imported
#	Internal bump stop
	Steering damper

- It is recommended that all new shock absorbers are fitted in pairs
- Do not mix gas and non-gas units on the same axle
- **Bold** part numbers indicate heavy-duty shocks
- Underlined part numbers indicate parts not immediately available
- *Italic* part numbers followed by > indicate parts to be discontinued

Passenger and light commercial

Part number [alphabetical listing]

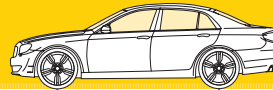

Year	Application	Front					Rear				
		Entry shocks	Premium shocks	Springs	Protection kits/ Mounting kits	Mounting information	Entry shocks	Premium shocks	Springs	Protection kits/ Mounting kits	Mounting information
MITSUBISHI <i>continued</i>											
Triton L200 <i>continued</i>											
	Raised Susp +-30mm	<i>AU360845</i> > (20mm longer)	-	<i>RS40054</i> > (25mm lift)		Raised 25mm		<i>RS55118C</i> > (40mm longer)	-		Raised 40mm
24-on	Triton LDV All 4x4 & 4x2 raised body Std height gen 6		-	-	-			-	-	-	
Xforce											
24-on	Xforce 1,5 SUV (NC)	-	-	-	-		-	-	-	-	
Xpander											
21-on	Xpander 1,5 crossover MPV (NC)	-	-	-	-		-	-	-	-	

MORRIS

OLD AUSTIN MINI see "Austin"

NEW MINI see "Mini"

DATSUN see "Datsun"

NISSAN

200SX

95-98	200SX Coupe (S14)	-	<i>"71968ST"</i> > <i>"71969ST"</i> >	-	-		-	-	-	-	
-------	-------------------	---	--	---	---	--	---	---	---	---	--

280ZX / 300ZX

84-89	300ZX Coupe elec susp & Turbo	-	-	-	-		-	<i>"5928ST"</i> > !	-	-	/
90-96	300ZX Coupe elec susp	-	<i>"71246ST"</i> >	-	-		-	-	-	-	

350Z / 370Z

03-05	350Z (Z33)	-	-	-	-		-	<i>"5795ST"</i>	-	-	⊗
-------	------------	---	---	---	---	--	---	-----------------	---	---	---

Almera / Sunny / Versa

01-May06	Almera Sedan Hatch (N16)	GT7261 R GT7262 L	-	1.6, 1.8, 1.5dCi = SP2756 & 2.2 = SP2755	"PK308" / "MK307"		<i>GT1035</i> > GT1036	-	SP2739	"PK306" / "MK298"	/ (no top rubber)
01-03	Almera / Sunny Hatch (N16E)	<i>"G7201"</i> R <i>"G7202"</i> L	-	-	"PK308" / "MK307"		<i>"23934"</i>	-	-	"PK306" / "MK298"	/ Smaller spring seat
12-23	Almera 1.5 (N17)	G7027 R G7028 L	-	-	-		G1134	-	-	-	⊙

E20

73-80	E20 Minibus	-	-	-	-	⊙	<i>V1029</i> > <i>D4437S</i>	-	-	-	⊙ T
81-95	E20 Van & Minibus	GT2094	M8047	-	-	⊙	<i>V1029</i> > <i>D4437S</i>	-	-	-	⊙ T

Hardbody-One Tonner

88-mid 99	1 Tonner 4x2 (AW) Hardbody, Hi Rider, Sani, D/Cab & Diesel (GD21)	GT2025 / M8046	<i>"D2113S"</i>	-	-	⊙ (M8046 no dustcover)	GT2031 / M8059	RS999113 / "D4463S"	-	-	⊙ ⊙
88-mid 99	1 Tonner 4x4 (AW) Hardbody, Sani, D/Cab & Diesel (MD21)	M4462	<i>RS55188</i> > / <i>"D4462S"</i>	-	-	⊙ (M8046 no dustcover)	M8059 / GT2031	RS999113 / "D4463S"	-	-	⊙ ⊙
	^ Twin shock (Additional double shock coilover unit)	M8051 ^	-	-	-	⊙ / S/pan unit					

Hardbody

Mid 99-07	Hardbody 4x2 (QW) LDV Hi-Rider D22	GT2025 / M8046	<i>"D2113S"</i>	-	-	⊙ (M8046 no dustcover)	GT2031 / M8059	RS999113 / "D4463S"	-	-	⊙ ⊙
Mid 99-07	Hardbody 4x4 & 4x2 Hi-Rider D/C (QW) LDV D22	M8030	<i>RS55188</i> / <i>"D4486"</i> > - / <i>"D4486S"</i> (4x4 only)	-	-	⊙	M8029	RS999341 / "D8487" > - / "D8487S" (4x4 Only)	-	-	⊙ ⊙

Key

*	See important installation information on inside front cover
!	Excluding self-leveling suspension
"..."	Special order - phone 010 900 1850. 6-12 week waiting period

-	Imported
#	Internal bump stop
⊕	Steering damper

- It is recommended that all new shock absorbers are fitted in pairs
- Do not mix gas and non-gas units on the same axle
- **Bold** part numbers indicate heavy-duty shocks
- Underlined part numbers indicate parts not immediately available
- *Italic* part numbers followed by > indicate parts to be discontinued

Passenger and light commercial

Part number [alphabetical listing]

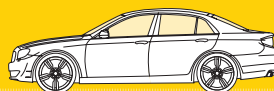

Year	Application	Front					Rear				
		Entry shocks	Premium shocks	Springs	Protection kits/ Mounting kits	Mounting information	Entry shocks	Premium shocks	Springs	Protection kits/ Mounting kits	Mounting information
NISSAN continued											
Interstar											
07-10	Interstar Van & Taxi	V2079	—	—	—	○ ○	V2514 (Leaf spring susp)	—	—	—	○ ○
							"V2512" (Air susp)	—	—	—	○ ○
Juke											
11-19	Juke FWD (F15)	G8237 R G8238 L	—	"SP4023" (1.5 & 1.6)	PK429 / MK462R & MK463L (INCL bearing)		G2174	—	—	PK430 / MK464 (INCL bearing)	⊥ ⊕
11-19	Juke AWD (F15)	G8237 R G8238 L	—	"SP4023" (1.5 & 1.6)	PK429 / MK462R & MK463L (INCL bearing)		G2175	—	—	PK430 /	⊥ ⊕
Leaf											
14-17	Leaf (ZE0)	—	—	—	—	—	"G2175"	—	—	—	—
18-23	Leaf (ZE1)	—	—	—	/ MK462R & MK463L (INCL bearing)	—	"G2175"	—	—	—	⊥ ⊕ (No dust cover)
Livina / Grand Livina / X-Gear											
07-13	Livina MPV 7 seater INCL X-Gear & Grand Livina (X11J)	GT7279 R GT7280 L	—	—	—		GT1072	—	—	—	⊥ ○ (Slightly shorter than OE)
Magnite											
21-on	Magnite crossover SUV 1.0T (DD0)	—	—	—	—	—	—	—	—	—	—
Maxima											
92-96	Maxima J30 Series	—	—	—	—		—	—	—	—	
95-early '00	Maxima QX (A32) (EXCL elec susp)	G16793 R G16794 L	—	—	—		G1259	—	—	—	⊥ ○
00-00	Maxima QX (A33) & Infinity (EXCL elec susp)	—	—	—	—	Check front OE #'s	—	"376152SP"	—	—	⊥ ○
01-03	Maxima QX (A33) & Infinity (EXCL elec susp)	—	"71461" R "71462" L	—	—	Check front OE #'s	—	"376152SP"	—	—	⊥ ○
Micra / March											
92-03	Micra (K11) cross border applications gen2	"10026" R "10027" L 92-July'00 OR "10058" R "10059" L Aug'00-03	—	—	—		"R3445"	—	—	—	⊥ ○
04-10	Micra (K12E) gen3	G7292 R G7293 L	—	"SP3503" (EXCL 1.5 & 1.6)	PK153 / MK263R & MK264L (EXCL bearing) / MK347 (bearing only)	 (large s/pan)	23972	—	"SP3503" (EXCL 1.5 & 1.6)	PK154	⊥ ○
11-June 18	Micra (K13) gen 4	G7027 R G7028 L	—	"SP4002" R "SP4003" L	/ MK458 (EXCL bearings)	 (small s/pan with stabi bar bkt)	G1134	—	"SP4011"	—	⊥ ○
July 18-22	Micra (K14) gen 5	—	—	—	—	—	—	—	—	—	—
Murano											
05-end 08	Murano 3.5 V6 4x4 SUV gen 1 (Z50)	—	72267ST R > 72268ST L >	—	/ MK301		—	"37282ST"	—	—	⊥ ⊕

Key

*	See important installation information on inside front cover
!	Excluding self-levelling suspension
"..."	Special order – phone 010 900 1850. 6-12 week waiting period

~	Imported
#	Internal bump stop
⊕	Steering damper

- It is recommended that all new shock absorbers are fitted in pairs
- Do not mix gas and non-gas units on the same axle
- **Bold** part numbers indicate heavy-duty shocks
- Underlined part numbers indicate parts not immediately available
- *Italic* part numbers followed by > indicate parts to be discontinued

Passenger and light commercial

Part number [alphabetical listing]

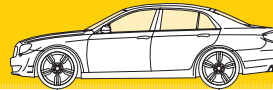

Year	Application	Front					Rear				
		Entry shocks	Premium shocks	Springs	Protection kits/ Mounting kits	Mounting information	Entry shocks	Premium shocks	Springs	Protection kits/ Mounting kits	Mounting information
NISSAN <i>continued</i>											
Navara											
05-March 17	Navara 4x2 & 4x4 2.5 dCi, 3.0, 4.0 V6 LDV (D40) Std height	D8070S	RS55787B	-	-	⊥ ⊕ S/pan unit (No top rubbers supplied)	AU160604	RS999311	-	-	○ ⊕
	Raised +-30mm	AU360832	"RS55787A"	<i>RS40017 ></i>	-	Raised +-30mm	AU160833	RS999311	-	-	Raised +-40mm
06-12	Note hatch (Cross border markets)	"G7309" "G7308"		-	-		23972	-	-	-	⊥ ⊕
April 17-on	Navara 4x2 Raised body & 4x4 LDV (D23) '21 facelift Std height	<u>M8356</u>	RS55787E		-	⊥ ⊕ S/pan unit	<u>M8357</u> (5 link coil susp) OR <u>M8058</u> (leaf spring susp)	RS55194A (5 link coil susp)		-	○ ⊕ (M8057 = top 16mm & btm 14mm) ○ ○ (M8058 = top & btm 16mm)
	Raised +-30mm	-	RS55787D	RS40040	-	Raised +-30mm	-	RS55264B (5 link coil susp)	RS40041	-	Raised +-30mm
NP200											
08-24	NP200 3/4 ton LDV	G7369	-	-	PK286 / MK300		G1158	-	-	PK314	⊥ ○
NP300											
08-21	NP300 4x2 LDV Hi-Rider (D22)	G72025 / M8046	"D2113S"	-	-	⊥ ⊕	G72031 / M8059	RS999113 / "D4463S"	-	-	○ ○
08-21	NP300 4x4 & 4x2 Hi-Rider D/C LDV (D22)	M8030	RS55188 / "D4486" > "D4486S" (4x4 only)	-	-	⊥ ⊕	M8029	RS999341 / "D8487" > "D8487S" (4x4 Only)	-	-	○ ○
One Tonner See Hardbody											
NV200											
14-on	NV200 panel van & 7 seater Combi MPV 1.6 & 1.5dci	G7431 G7432	-	-	/ MK347 (bearings only)		G2179 > G1454	-	-	-	⊕ ⊕
NV350											
14-on	NV350 panel van & 16 seater "Impendulo" minibus taxi 2.5 (E26)	M8354	-	-	-	⊥ ⊕	M8355	-	-	-	○ ⊕
Pathfinder											
05-15	Pathfinder 4x4 SUV (R51)	D8069S	RS55787B	"SP4094"	-	⊥ ⊕ S/pan unit	D8068S	<i>RS999312 ></i>	"SP4095"	-	⊕ ⊕
Patrol											
72-80	Patrol S/W 4x4	<u>D4470</u> > D4470S	-	-	-	⊥ T	<u>D4470</u> > D4470S	-	-	-	⊥ T Check mounting configuration
80-89	Patrol S/W 4x4 MQ / MK / 160 / 260	<u>D4470</u> > D4470S	-	-	-	⊥ T	<u>AU161712</u> > <u>D4437S</u>	-	-	-	○ T Check mounting configuration
89-97	Patrol S/W 4x4 GQ / GR Y60 Series (Coil springs)	<u>AU160207</u> >	<i>RS999201 ></i>	-	-	⊥ T 10mm OD studs	<u>AU160208</u> >	RS999202	-	-	○ ○ 19mm ID holes
	Steering Damper ⊕	"SC2959" > ⊕ (Australia)				⊥ T					
98-17	Patrol S/W 4x4 GR I / GU I Y61 Series (Coil springs) '02-on 3.0TDi & 4.8i GR II / GU II series Std height	D8483S	RS999342	-	-	⊥ T 14mm OD Studs	<u>D4484</u> > D4484S	RS999202	-	-	○ ⊕ Top 19.5id hole / Btm 19.2 id hole
	Raised 50mm		"RS55211" > (50mm longer)	-	-	Raised 50mm					Raised 50mm
13-on	Patrol S/W 4x4 Y62 Series [Cross border mkt from 2013, RSA mkt from end 2017] body motion control)			-	-	⊥ ⊕ S/pan unit					⊥ ⊕

Key

*	See important installation information on inside front cover
!	Excluding self-levelling suspension
"..."	Special order - phone 010 900 1850. 6-12 week waiting period

~	Imported
#	Internal bump stop
⊕	Steering damper

- It is recommended that all new shock absorbers are fitted in pairs
- Do not mix gas and non-gas units on the same axle
- **Bold** part numbers indicate heavy-duty shocks
- Underlined part numbers indicate parts not immediately available
- *Italic* part numbers followed by > indicate parts to be discontinued

Passenger and light commercial

Part number [alphabetical listing]

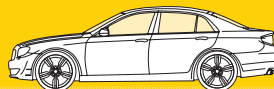

Year	Application	Front					Rear				
		Entry shocks	Premium shocks	Springs	Protection kits/ Mounting kits	Mounting information	Entry shocks	Premium shocks	Springs	Protection kits/ Mounting kits	Mounting information
NISSAN continued											
Patrol											
07-on	Patrol 4.2D Pick-Up 4x4 LDV Leaf spring rear (Y61)	D8483S	RS999342	-	-	⊥ / ⊥ 14mm OD Studs	AU160499	-	-	-	⊖ ⊕
Primastar											
07-14	Primastar van 1.9 Dci gen 2 (X83)	V4504	-	-	PK116 / MK181 (MC bearings)		V1167	-	-	-	⊖ ⊖
Primera											
Sept'98-02	Primera 1.6 Si ; 2.0 Si & Gsi 2.0 Sti	23872 (check OE #)	-	-	"PK062"	⊥ ⊖ Only for OE #'s 561102F000 & 561102F025	23868 (check OE #)	-	-	-	⊥ ⊖ Only for OE #'s 562102F000 or 562102F025
Sept'98-02	Primera 2.0 Sti	23872 (check OE #)	-	-	"PK062"	⊥ ⊖ Only for OE #'s 561102F500 & 561102F525	23869 (check OE #)	-	-	-	⊥ ⊖ Only for OE #'s 562102F500 or 562102F525
Qashqai											
07-09	Qashqai SUV All (J10)	-	D0023R / D0024L	"SP3697"	PK307 / MK334R & MK335L		-	D7018S	"SP3700"	PK309	⊖ ⊖
10-June'14	Qashqai SUV all +2, 1.5dci, 1.6, 2.0 (J10 facelift)	-	D0025 > D0025R / D0026L	"SP3698"	PK307 / MK334R & MK335L		-	D7018S	"SP3700" +2) OR "SP3969" (+2)	PK309	⊖ ⊖
10-June'14	Qashqai SUV 2.0 dci (J10 facelift, +2)	-	D0023R / D0024L	"SP3699"	PK307 / MK334R & MK335L		-	D7018S	"SP3701" +2) OR "SP3969" (+2)	PK309	⊖ ⊖
July'14-Sept'22	Qashqai SUV 1.2T, 1.5dci, 1.6dci 4x2 and 1.6dci 4x4 (J11)	-	D0049R / D0050L	1.2 = "SP4166" 1.5 = "SP4164" 1.6 = "SP4165"	/MK434 bearings)		-	D7034 > D7034S (check mountings) OR D7019S (check mountings)	4x2 = "SP4167" 1.6 4x4 = "SP4178"	-	⊖ ⊕ open 320mm / closed 469mm (Check mountings)
Oct 22-on	Qashqai SUV 1.3T, 1.5 2WD (J12)	-	-	-	-	-	-	-	-	-	⊖ ⊖ open 324mm / closed 507mm (Check mountings)
Safari											
82-89	Safari (4x4) MQ	D4470 > D4470S	-	-	-	⊥ ⊕	AU161712 > D4437S	-	-	-	⊖ ⊕
Sani											
82-88	Sani Wagon 4x4	M4462	RS55188 >	-	-	⊥ ⊖	M4441	RS999341	-	-	⊖ ⊖
88-00	Sani Wagon 4x2	M8046	-	-	-	⊥ ⊖	GT2031 / M8059	-	-	-	⊖ ⊖
88-00	Sani Wagon 4x4	M4462	RS55188 >	-	-	⊥ ⊖	M8059 / GT2031	RS999113	-	-	⊖ ⊖
	^ Twin shock (Additional double shock coilover unit)	M8051 ^	-	-	-	⊥ ⊖	-	-	-	-	-
Sentra / Sabre / Sunny											
88-91	Sentra Sedan & Coupe Twincam (B12 Sunny)	GT7232	-	-	-	Welded b/hose bracket & not a stud	GT7231	-	-	PK058	
92-7/01	Sentra 140 (B13 Sunny)	GT7239 GT7240	-	-	PK036		GT7234 GT7235	-	SP0502	-	
92-7/01	Sentra & Sabre 160 (B13 Sunny)	GT7239 GT7240	-	SP2750	PK036		GT8031 GT8032	-	SP0502	-	 (Flat on piston rod)
92-7/01	Sentra & Sabre 200 ABS (B13 Sunny)	GT7239 GT7240	-	SP2750	PK036	ABS)	GT8026 > GT8027 > GT8031 GT8032	-	SP0502	-	 (Flat on piston rod)

Key

*	See important installation information on inside front cover
!	Excluding self-levelling suspension
...	Special order - phone 010 900 1850. 6-12 week waiting period

~	Imported
#	Internal bump stop
⊖	Steering damper

- It is recommended that all new shock absorbers are fitted in pairs
- Do not mix gas and non-gas units on the same axle
- **Bold** part numbers indicate heavy-duty shocks
- Underlined part numbers indicate parts not immediately available
- *Italic* part numbers followed by > indicate parts to be discontinued

Passenger and light commercial

Part number [alphabetical listing]

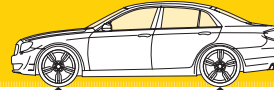

Year	Application	Front					Rear				
		Entry shocks	Premium shocks	Springs	Protection kits/ Mounting kits	Mounting information	Entry shocks	Premium shocks	Springs	Protection kits/ Mounting kits	Mounting information
NISSAN <i>continued</i>											
Sentra / Sabre / Sunny <i>continued</i>											
2013	Sentra 1.6 (B17 Sylphy / Pulsar)	–	<i>72947ST R ></i> <i>72948ST L ></i>				–	–			 (open length 517mm)
14-17	Sentra 1.6 (B17 Sylphy / Pulsar)	–	<i>72947ST R ></i> <i>72948ST L ></i>				–	<i>5532ST ></i>			 (open length 514mm)
Skyline											
82-Mid 87	Skyline Sedan & Hatch (Solid axle)	–	–	–	–		–	–	–	–	 S/pan unit
Mid 87-92	Skyline All (incl New Era)	GT0114	–	–	–		–	–	–	–	 S/pan unit
Terrano											
98-02	Terrano II 3 & 5 door (R20)	–	–	–	–	 	–	"D8003S"	–	–	
Tiida											
Aug'06-13	Tiida 1.6 & 1.8 Hatch / Sedan gen 1 (X11C)	GT7279 GT7280	–	–	PK = 63631MM / MK = 908916MM & 908917MM / MK347 (bearing only)		GT1072	–	–	–	
Tracker											
80-82	Tracker (4x4)	M4462	–	–	–	 	<i>AU161712 ></i> D4437S	–	–	–	
82-88	Tracker (4x4) (incl Sani)	M4462	–	–	–	 	M4441	–	–	–	
X-TRAIL											
02-March '08	X-Trail All gen 1 (T30)	–	<i>744134SP R</i> <i>744135SP L</i>	"SP3666"	PK310 / MK301 (incl bearings)		–	<i>744136SP R</i> <i>744137SP L</i>	"SP3665"	PK311	
April '08-Aug'14	X-Trail All gen 2 (T31)	D0027R / D0028L	–	–	PK307 / MK334R & MK335L (incl bearings)		D7019S	–	–	–	
Sept '14-23	X-Trail All gen 3 (T32)	D0047R / D0048L	–	"SP0139"	MK434 (incl bearings)		D7019S	–	–	–	
May 22-on	X-Trail All gen 4 (T33)		–	–	–			–	–	–	
OPEL											
Adam											
14-19	Adam 1.0T, 1.4 (incl "S" (M13))	G7413 G7414	–	–	PK140 /		G1181	–	–	PK431 / MK384R & MK385L (incl bearings)	
Ascona											
82-86	Ascona	–	–	–	–		GT1024	–	–	–	
Note – For older Astra models see "Kadett"											
Astra											
Nov'99-Sept'04	Astra hatch & Classic sedan (G) (incl OPC & S/W)	GT8024 GT8025	–	1.6 = <i>SP0020 ></i> , <i>SE0020</i> 2.0 = SP0313	PK075 (Bump rubber only) / MK149	 Top OE plastic ring may need to be broken to fit new aftermarket shocks Replacement rings available from GM dealers	GT1030	–	1.4 & 1.6 = "SN0427", 1.8 & 2.0 = SP3300	–	

Key

*	See important installation information on inside front cover
!	Excluding self-leveling suspension
"..."	Special order – phone 010 900 1850. 6-12 week waiting period

~	Imported
#	Internal bump stop
	Steering damper

- It is recommended that all new shock absorbers are fitted in pairs
- Do not mix gas and non-gas units on the same axle
- **Bold** part numbers indicate heavy-duty shocks
- Underlined part numbers indicate parts not immediately available
- *Italic* part numbers followed by > indicate parts to be discontinued

Passenger and light commercial

Part number [alphabetical listing]



Year	Application	Front					Rear				
		Entry shocks	Premium shocks	Springs	Protection kits/ Mounting kits	Mounting information	Entry shocks	Premium shocks	Springs	Protection kits/ Mounting kits	Mounting information
OPEL continued											
Astra continued											
01-Sept'04	Astra Caravan S/Wagon (G)	GT8024 R GT8025 L	—	1.6 = <i>SP0020</i> > SE0020 2.0 = SP0313	PK075 (Bump rubber only) / MK149 EXCL bearings)	Top OE plastic ring may need to be broken to fit new aftermarket shocks Replacement rings available from GM dealers	23982	—	—	—	⊖ ⊖
Sept'04-09	Astra 1.4 & 1.6 (model H)	G8001 R G8002 L	—	SP2862	PK164 / MK399 EXCL bearings), or "MK482" INCL bearings	⊖	23982 !	—	SP2868	—	⊖ ⊖
Sept'04-09	Astra 1.8, & 1.9 CDTi INCL GTC EXCL elec susp (model H)	G8003 R G8004 L	—	1.8 = "SE2863", 1.9 = SP2866	PK164 / MK399 EXCL bearings), or "MK482" INCL bearings	⊖	23982 !	—	SP2868	—	⊖ ⊖
Sept'04-09	Astra 2.0 Turbo Sport INCL GTC EXCL OPC, Elec susp) (model H)	—	—	SP2866	PK164 / MK399 EXCL bearings), or "MK482" INCL bearings	⊖	!	—	SP2868	—	⊖ ⊖
end 10-May 16	Astra EXCL OPC, GTC, Elec susp) (J)	G8195 R G8196 L	—	"SP4010 EXCL 1.3 Cdti & 2.0)	PK447 / MK381 INCL bearings)	⊖	G1154 !	—	"SN3987" EXCL sport) / MK472 EXCL bearings)	⊥ ⊖	⊥ ⊖
June 16-21	Astra EXCL OPC, Coupe, Sports or Elec susp) B16 (K)	G8621 R G8622 L	—	—	—	⊖	—	376256SP	—	⊥ ⊖	⊥ ⊖
Astra Coupe											
01-06	Astra Coupe & Cabriolet (G)	GT8024 R GT8025 L	—	—	PK075 (Bump rubber only) / MK149 EXCL bearings)	⊖	"23908"	—	—	—	⊖ ⊖
07-10	Astra Twintop 1.8 & 2.0	G8003 R G8004 L	—	—	PK164 / MK399 EXCL bearings), or "MK482" INCL bearings	⊖	23982 !	—	—	—	⊖ ⊖
11-18	Astra GTC coupe INCL OPC (J)	—	—	—	MK381 INCL bearings)	—	—	—	—	"PK480" / MK472 EXCL bearings)	—
Calibra											
92-98	Calibra 2.0 16v & 2.5 V6 EXCL Turbo)	"MG247"	—	—	PK004 / "MK038"	⊖	"23431"	—	—	—	⊥ ⊖
Combo											
02-11	Combo Panel Van (C)	G16327 R > G16328 L > G17208 R G17209 L	—	—	PK173 / MK149 EXCL bearings) (PK173 – no dust cover)	⊖	23964	—	—	—	⊖ ⊖
18-on	Combo Cargo Panel Van & Life minibus 1,6TD (E)	G8653	—	—	MK381 EXCL bearings)	⊖	G2257	—	—	—	⊖ ⊖
Corsa											
96-02	Corsa Hatch & Notch INCL Corsa LITE & Lite Sport (B)	GT7210	—	—	PK004 / MK017 INCL bearings)	⊖	GT1029 # *15 Use supplied rubbers. Do not re-use Opel OE rubbers or metal sleeve	—	—	—	⊥ ⊖ Internal bump stop

Key

*	See important installation information on inside front cover
!	Excluding self-levelling suspension
"..."	Special order – phone 010 900 1850. 6-12 week waiting period

~	Imported
#	Internal bump stop
⊖	Steering damper

- It is recommended that all new shock absorbers are fitted in pairs
- Do not mix gas and non-gas units on the same axle
- **Bold** part numbers indicate heavy-duty shocks
- Underlined part numbers indicate parts not immediately available
- *Italic* part numbers followed by > indicate parts to be discontinued

Passenger and light commercial

Part number [alphabetical listing]

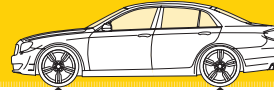

Year	Application	Front					Rear				
		Entry shocks	Premium shocks	Springs	Protection kits/ Mounting kits	Mounting information	Entry shocks	Premium shocks	Springs	Protection kits/ Mounting kits	Mounting information
OPEL continued											
Corsa continued											
02-15	Corsa LITE & Lite Sport – old shape Corsa hatch (B)	GT7210	–	–	PK004 / MK017 [INCL] bearings)		GT1029 # *15 Use supplied rubbers. Do not re-use Opel OE rubbers or metal sleeve	–	–	–	
End 02- Oct'07	Corsa Hatch & Classic [EXCL] Lite) (C)	GT7208 R GT7209 L	<i>742089SP</i> R > <i>742090SP</i> L >	1.2 = <i>SP2792</i> > "SE2792", 1.4 & 1.6 = <i>SP2794</i> > <i>SE2794</i>	PK173 / MK149 [EXCL] bearings) OR MK343 [INCL] bearings	(PK173 – no dust cover)	GT1029 # *15 Use supplied rubbers. Do not re-use Opel OE rubbers or metal sleeve	–	<i>SP2788</i> > <i>SN2788</i> [EXCL] Sport & Gsi)	–	
Nov'07- Oct'15	Corsa Hatch [EXCL] Lite, OPC and Sport) (D)	G8063 R G8064 L	–	"SE3548"	PK140 / MK305 [INCL] bearings)		G1037	–	"SE3547"	PK018 / MK384R & MK385L [EXCL] bearings)	
Nov'15-19	Corsa Hatch 1.0T, 1.4 [INCL] 1.4 Turbo Sport (E)	–	<i>742272SP</i> R <i>742273SP</i> L	"SP4225"	PK140 / MK305 [INCL] bearings)		–	376249SP	"SP4226"	PK431 / MK384R & MK385L [EXCL] bearings)	
20-on	Corsa Hatch 1,2, 1,2T [EXCL] Sport) (F)	–	–	–	–	–	–	–	–	–	–
Corsa bakkie											
96-Late 04	Corsa LDV	GT7210	–	–	PK004 / MK017 [INCL] bearings)		GT1021	–	–	–	
8/04-10	Corsa Utility LDV	GT7263 R GT7264 L	–	–	PK173 / MK149 [EXCL] bearings)	(PK173 – no dust cover)	GT2082	–	–	–	
For newer Chev Utility models ... see "Utility"											
Corsa Pronto Van											
98-02	Corsa Pronto Panel Van	GT7210	–	–	PK004 / MK017 [INCL] bearings)		GT1029 # *15 Use supplied rubbers. Do not re-use Opel OE rubbers or metal sleeve	–	–	–	
Crossland											
17-on	Crossland & Crossland X 1,2T SUV (P17)	G8649 R G8650 L	–	–	PK410 / MK509 [INCL] bearings)		G1257	–	–	–	
Grandland											
18-on	Grandland & Grandland X 1,6T SUV (A18)	–	<i>742287SP</i>	–	PK434 / MK433 [EXCL] bearings)		–	<i>376264SP</i>	–	–	
Kadett / Monza / Astra											
80-Mid 85	Kadett FWD (D)	GT0117 [INCL] Centralising Ring	–	–	PK004	 Use supplied centralising ring	GT1024	–	–	–	
80-Mid 85	Kadett S/Wagon FWD (D)	GT0117 [INCL] Centralising Ring	–	–	PK004	 Use supplied centralising ring	GT1028	–	–	–	
Mid 85-88	Kadett & Monza Sedan "T car" (E) [INCL] Gsi & Cabriolet	GT0117 [INCL] Centralising Ring	–	2.0 = <i>SP0202</i> >	PK004 / MK037	 Use supplied centralising ring	GT1024	–	<i>SP0405</i> > "SN0405" [EXCL] 2.0)	–	
89-92	Kadett & Monza Sedan [INCL] Cub & Gsi 2.0) (F.W.D) "T car" (E)	GT0117 [INCL] Centralising Ring	–	2.0 = <i>SP0202</i> >	PK004 / MK037	 Use supplied centralising ring	GT1025 *7	–	<i>SP0405</i> > "SN0405" [EXCL] 2.0)	–	

Key

*	See important installation information on inside front cover
!	Excluding self-levelling suspension
"..."	Special order – phone 010 900 1850. 6-12 week waiting period

~	Imported
#	Internal bump stop
	Steering damper

- It is recommended that all new shock absorbers are fitted in pairs
- Do not mix gas and non-gas units on the same axle
- **Bold** part numbers indicate heavy-duty shocks
- Underlined part numbers indicate parts not immediately available
- *Italic* part numbers followed by > indicate parts to be discontinued

Passenger and light commercial

Part number [alphabetical listing]

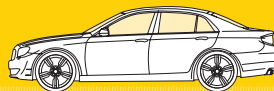

Year	Application	Front					Rear				
		Entry shocks	Premium shocks	Springs	Protection kits/ Mounting kits	Mounting information	Entry shocks	Premium shocks	Springs	Protection kits/ Mounting kits	Mounting information
OPEL continued											
Corsa continued											
93-Oct'99	Kadett & Astra [EXC] S/W) Z	GT0119 / "MG259" (Firm ride)	—	1.4 & 1.6 = SP0254 > 1.8 = "SP1621"	PK005 / MK039	Use supplied centralising ring	GT1027	—	SP0405 > "SN0405"	—	⊥ ⊕
93-Oct'99	Astra Estate S/Wagon Z	GT0119 / "MG259" (Firm ride)	—	1.8 & 2.0 = "SP1621"	PK005 / MK039	Use supplied centralising ring	GT1028	—	—	—	⊕ T
Note – For newer Astra models see "Astra"											
Meriva											
03-09	Meriva 1.4, 1.6, 1.7CDTi, 1.8 mini MPV (A)	G16327 R > G16328 L > GT7208 R GT7209 L	—	1.4, 1.6, 1.8 = "SE2838" / 1.7CDTi = "SE2837"	PK173 / MK149 [EXC] bearings) / MK343 (bearings only)	(PK173 – no dust cover)	23964	—	"SN3466"	—	⊕ ⊕
10-17	Meriva 1.4 mini MPV B	—	742194SP R 742195SP L	"SE3415"	PK164 / MK149 [EXC] bearings) / MK343 (bearings only)		—	376135SP	"SP3988"	—	⊕ ⊕
Mokka X											
15-April 22	Mokka & Mokka X cross-over SUV FWD [EXC] AWD) [Facelift Aug '16] gen 1 (J13)	—	D0040R / D0041L	1.4, 1.6 = "SP4179" / 1.7CDTi = "SP4180"	/ MK487 [EXC] bearings) / MK381 (bearings only)		—	D7024 > D7024S	"SP4193"	—	⊥ ⊕
May 22-on	Mokka X 1,2T cross-over SUV FWD [EXC] AWD) gen 2 B	—	—	—	—	—	—	—	—	—	—
Movano											
98-12	Movano Van Mk1 [EXC] pick-up rear) (X70)	V2079	—	"SP2825"	—	⊕ ⊕	V2514 (leaf spring van) "V2512" (leaf spring pick-up & air spring van)	—	—	—	⊕ ⊕
Omega											
01-06	Omega 2.2Dti, 2.5 all, 2.6, 3.0, 3.2 [EXC] S/Wagon) (V94)	"G16657"	—	—	"PK064" / "MK065" [EXC] bearings)		"R3425" !	—	—	—	⊕ ⊕
Rekord / Commodore											
67-73	Rekord 4 Cylinder	V1063	—	—	—	⊥ ⊕	"R3216" ~	—	—	—	⊥ ⊕
68-73	Rekord All 6 Cylinder	V1063	—	—	—	⊥ ⊕	GA2056 >	—	—	—	⊥ ⊕
78-91	Rekord & Commodore Sedan	GT0116	—	—	PK005	Use supplied centralising ring	R1566	—	—	—	⊥ ⊕
78-91	Rekord & Commodore S/Wagon	GT0116	—	—	PK005	Use supplied centralising ring	GA2056 >	—	—	—	⊥ ⊕
91-95	Rekord 4 Cylinder (Solid Axle)	GT0116	—	—	PK005	Use supplied centralising ring	R1566	—	—	—	⊥ ⊕
91-95	Rekord 6 Cylinder (I.R.S.)	GT0116	—	—	PK005	Use supplied centralising ring	—	—	—	—	⊥ ⊕
Senator											
79-86	Senator	GT0116	—	—	PK005	Use supplied centralising ring	—	—	—	—	—

Key

*	See important installation information on inside front cover
!	Excluding self-levelling suspension
"..."	Special order – phone 010 900 1850. 6-12 week waiting period

~	Imported
#	Internal bump stop
⊕	Steering damper

- It is recommended that all new shock absorbers are fitted in pairs
- Do not mix gas and non-gas units on the same axle
- **Bold** part numbers indicate heavy-duty shocks
- Underlined part numbers indicate parts not immediately available
- *Italic* part numbers followed by > indicate parts to be discontinued

Passenger and light commercial

Part number [alphabetical listing]

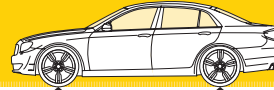

Year	Application	Front					Rear				
		Entry shocks	Premium shocks	Springs	Protection kits/ Mounting kits	Mounting information	Entry shocks	Premium shocks	Springs	Protection kits/ Mounting kits	Mounting information
OPEL continued											
Tigra											
05-09	Tigra 1.4, 1.8 TwinTop Cabriolet	"G16329" R "G16330" L		–	PK173 / MK149	 (PK173 – no dust cover)	"22712" (rear disc brakes only)		–	–	\perp \circ (rear disc brakes only)
Vivaro											
07-14	Vivaro 1.9CDTi, 2.0 Van & Minibus (X83)	V4504	–	–	PK116 / MK181 (MS bearings)		V1167	–	–	–	\oplus \oplus
19-on	Vivaro 2.0TD Van (K0)		–	–			G2258	–	–	–	\oplus \oplus
Zafira											
01-05	Zafira 1.6, 1.8, 1.9CDTi, 2.2 MPV (MS 2.0 turbo & OPC) (A)	G16790 R G16791 L	742114SP R > 742115SP L >	–	PK075 / MK149	 Top OE plastic ring may need to be broken to fit new aftermarket shocks Replacement rings available from Opel dealers	23915	376102SP >	–	–	\oplus \oplus
July '05-10	Zafira 1.6, 1.8, 1.9CDTi MPV (Exc OPC, Sport & Panoramic) B	G8003 R G8004 L	–	–	PK164 / MK399		G1061 !	376101SP >	–	–	\oplus \oplus
19-on	Zafira Life 2.0TD Minibus (K0)		–	–			G2258	–	–	–	\oplus \oplus
PEUGEOT											
107											
07-15	107 Hatch 1.0	G7019 R G7020 L	–	–	PK178 / MK351		G1075	–	–	PK333 / MK471	\perp \circ
1007											
06-08	1007 Harch 1.6	G16449 R G16450 L	–	–	"PK348" / MK001		23966	–	–	–	\circ \circ
206											
00-12	206 1.4, 1.6 XS, 1.6 XT, 2.0 HDi & 20 Gti Hatch (2A/C)	G16446 R G16447 L	–	–	"PK085" / MK143R & MK144L		43109	–	–	–	\oplus \oplus
206											
02-12	206 S/Wagon 1.6	G16446 R G16447 L	–	–	"PK362" / MK143R & MK144L		43109	–	–	–	\oplus \oplus
206 CC											
02-5/07	206 Cabrio cc	G8611A R G8612A L	742180SP R > 742181SP L >	–	"PK362" / MK143R & MK144L		43109	376166SP >	–	–	\oplus \oplus
207											
06-12	207 1.4 Hatch (For 1.4 HdI check front strut OD is 47mm)	G8097 R G8098 L	–	–	PK150 / MK001 (bearing only) & MK321A (no bearings)	 Btm Strut body OD = 47mm	G2108	–	–	–	\oplus \oplus
06-12	207 1.6 VTi, 1.4 HdI & 1.6 HdI Hatch (For 1.4 HdI check front strut OD is 51mm)	G8099 R G8100 L	–	–	PK150 / MK001 (bearing only) & MK321A (no bearings)	 Btm Strut body OD = 51mm	G2108	–	–	–	\oplus \oplus
06-12	207 1.6 Gti T Hatch	G8099 R G8100 L	–	–	PK150 / MK001 (bearing only) & MK321A (no bearings)	 Btm Strut body OD = 51mm	–	–	–	–	\oplus \oplus

Key

*	See important installation information on inside front cover
!	Excluding self-levelling suspension
"..."	Special order – phone 010 900 1850. 6-12 week waiting period

~	Imported
#	Internal bump stop
\oplus	Steering damper

- It is recommended that all new shock absorbers are fitted in pairs
- Do not mix gas and non-gas units on the same axle
- **Bold** part numbers indicate heavy-duty shocks
- Underlined part numbers indicate parts not immediately available
- *Italic* part numbers followed by > indicate parts to be discontinued

Passenger and light commercial

Part number [alphabetical listing]

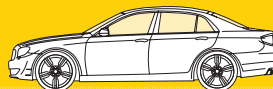

Year	Application	Front					Rear				
		Entry shocks	Premium shocks	Springs	Protection kits/ Mounting kits	Mounting information	Entry shocks	Premium shocks	Springs	Protection kits/ Mounting kits	Mounting information
PEUGEOT <i>continued</i>											
207 CC											
June'07-12	207 Cabrio cc 1.6 THP Turbo	G8099 R G8100 L	—	—	PK150 / MK001 (bearing only) & MK321A (no bearings)	 Btm Strut body OD = 51mm	G2108	—	—	—	
208											
Oct'12-19	208 1.0, 1.2T, 1.4, 1.6 Type 1, 2 & 3 susp (check front strut lower outer diamer) gen 1 (A9)	G8221 R G8222 L	—	—	PK410 / MK382 (excl) bearings) or MK001 (bearings only)	 Btm Strut body OD = 47mm	G1177	—	—	PK446 /	
Oct'12-19	208 1.4 Hdi, 1.6 GTi, 1.6 Hdi Type 3 susp (check front strut lower outer diamer & brake hose bracket) gen 1 (A9)	G8223 R G8224 L	—	—	PK410 / MK382 (excl) bearings) or MK001 (bearings only)	 Btm Strut lower body OD = 51mm / Check brake hose bracket vs G8225 / 6	G1177	—	—	PK446 /	
Oct'12-20	208 1.4 Hdi, 1.6 16v Turbo GTi, 1.6 Hdi Type 4 susp (check front strut lower outer diamer & brake hose bracket) gen 1 (A9)	G8225 R G8226 L	—	—	PK410 / MK382 (excl) bearings) or MK001 (bearings only)	 Btm Strut lower body OD = 51mm / Check brake hose bracket vs G8223 / 4	G1177 or Alt type 5 susp models = G2108	—	—	PK446 /	 (G2108 Type 5 susp top mtng 10x55 & btm mtng 12x48)
19-on	208 1.2T gen 2 (P21)	—	—	—	—	—	—	—	—	—	—
2008											
13-19	2008 Crossover SUV 1.2T, 1.6 gen 1 (CU / A94)	—	742206SP R 742207SP L OR 742208SP R 742209SP L	—	MK382 (excl) bearings) or MK001 (bearings only)	 Check lower strut base OD : 742206SP (R) 742207SP (L) (47mm OD lower strut base) or 742208SP (R) 742209SP (L) (51mm OD lower strut base)	—	376136SP	—	—	
19-on	2008 Crossover SUV 1.2T gen 2 (P24)	—	—	—	—	—	—	—	—	—	—
306											
98-02	306 Hatch, 1.6 Sedan and S/Wagon	"R8001" R "R8002" L	—	—	PK006 / "MK097" (Power steering only)		42041	—	—	—	

Key

*	See important installation information on inside front cover
!	Excluding self-levelling suspension
"..."	Special order – phone 010 900 1850. 6-12 week waiting period

~	Imported
#	Internal bump stop
⊕	Steering damper

- It is recommended that all new shock absorbers are fitted in pairs
- Do not mix gas and non-gas units on the same axle
- **Bold** part numbers indicate heavy-duty shocks
- Underlined part numbers indicate parts not immediately available
- *Italic* part numbers followed by > indicate parts to be discontinued

Passenger and light commercial

Part number [alphabetical listing]

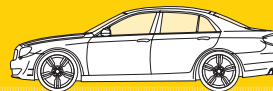

Year	Application	Front					Rear				
		Entry shocks	Premium shocks	Springs	Protection kits/ Mounting kits	Mounting information	Entry shocks	Premium shocks	Springs	Protection kits/ Mounting kits	Mounting information
PEUGEOT continued											
306 continued											
93-97	306 CC Cabrio	"G16422" R "G16423" L	—	—	PK006 / "MK097" (Power steering only)		42041	—	—	—	⊕ ⊕
97-2/04	306 CC Cabrio	"R8001" R "R8002" L	—	—	"MK097" (Power steering only)		42041	—	—	—	⊕ ⊕
307											
02-10	307 1.6 & 2.0 hatch & 2.0 S/Wagon EXCL cc)	G7265 R G7266 L	—	—	"PK124" / "MK196"		25504	—	—	"PK131" / "MK205"	⊥ ⊕
March '04-10	307 CC Cabrio	G7265 R G7266 L	—	—	"PK124" / "MK196"		"G2249"	—	—	"PK131" / "MK205"	⊥ ⊕
308											
08-14	308 1.2T, 1.6 & 1.6Hdi Hatch. EXCL S/W, Vti, GT, 1.6 Turbo 147kw & CC gen 1 (T7)	G7329 R G7330 L	—	—	"PK124" / MK001 (bearings only) & MK322 EXCL bearings)		G2217	—	—	"PK131"	⊥ ○
08-14	308 1.6T, 1.6 Vti & GT Turbo & 2.0Hdi Turbo Hatch EXCL S/W & CC gen 1 (T7)	G8127 R G8128 L	—	—	"PK124" / MK001 (bearings only) & MK322 EXCL bearings)		G2217	—	—	"PK131"	⊥ ○
08-10	308 1.6 S/Wagon EXCL 1.6T gen 1 (T7)	G7329 R G7330 L	—	—	"PK124" / MK001 (bearings only) & MK322 EXCL bearings)		"25505"	—	—	"PK131"	⊥ ○
09-14	308 Cabrio cc 1.6 T gen 1 (T7)	G8127 R G8128 L	—	—	"PK124" / MK001 (bearings only) & MK322 EXCL bearings)		—	—	—	"PK131"	⊥ ○
14-21	308 1.2T gen 2 (T9)	G6831	—	—	PK434 / MK433 EXCL bearings)		G1240	—	—	—	⊥ ○
3008											
09-17	3008 MPV Crossover 1.6, 1.6 T, 2.0 Hdi gen 1 EXCL self leveling susp) (T8 / OU)	G8383 R G8384 L	742190SP R > 742191SP L >	—	"PK124" / "MK395"		G2241 !	376151SP > !	—	"PK131"	⊥ ⊕
17-on	3008 MPV 1.2T, 1.6T, 2.0 Hdi Crossover gen 2 EXCL self leveling susp) (P84 / MC, MR, MJ, M4)	—	742287SP	—	PK434 / MK433 EXCL bearings)		—	376264SP !	—	—	⊥ ⊕
404											
60-79	404 Sedan	"MR904"	—	—	—		"R5410"	—	—	—	⊥ T
65-79	404 S/Wagon	"MR904"	—	—	—		—	—	—	—	⊕ ⊕
60-81	404 LDV	"MR904"	—	—	—		"R5433"	—	—	—	⊕ ⊕
405											
93-95	405 Sedan & station wagon EXCL Sri, Stl, Mi16 & T16)	"11616"	—	—	PK006 / "MK012"		"43063"	—	—	—	⊕ ⊕
406											
95-04	406 Sedan EXCL elec susp)	11753 R 11754 L	—	—	"PK087" / "MK115"		R6652 !	—	—	"PK103" / "MK186"	⊥ ⊕
96-04	406 2.0 Estate S/Wagon EXCL elec susp)	11753 R 11754 L	—	—	"PK087" / "MK115"		R6653 !	—	—	"PK103"	⊥ ⊕
97-Feb'06	406 Coupe 3.0 EXCL elec susp)	11753 R 11754 L	—	—	"PK087" / "MK115"		"G2237" !	—	—	"MK186"	⊥ ⊕

Key

*	See important installation information on inside front cover
!	Excluding self-levelling suspension
"..."	Special order – phone 010 900 1850. 6-12 week waiting period

~	Imported
#	Internal bump stop
⊕	Steering damper

- It is recommended that all new shock absorbers are fitted in pairs
- Do not mix gas and non-gas units on the same axle
- **Bold** part numbers indicate heavy-duty shocks
- Underlined part numbers indicate parts not immediately available
- *Italic* part numbers followed by > indicate parts to be discontinued

Passenger and light commercial

Part number [alphabetical listing]



Year	Application	Front					Rear				
		Entry shocks	Premium shocks	Springs	Protection kits/ Mounting kits	Mounting information	Entry shocks	Premium shocks	Springs	Protection kits/ Mounting kits	Mounting information
PEUGEOT <i>continued</i>											
407											
Mid 04-10	407 Sedan 2.0 ST (301 elec susp)	26669	376183SP > !	-	"PK188" / "MK319"	⊥ ○	26671 !	-	-	"PK313"	⊥ ○
Mid 04-10	407 Sedan 2.0 Hdi, 2.2 ST Sport, 3.0 ST (301 Coupe & Elec susp)	26670	-	-	"PK188" / "MK319"	⊥ ○	26671 !	-	-	"PK313"	⊥ ○
407											
End 04-08	407 S/Wagon 2.0 Hdi, 2.2 Sport, 3.0 Sport (301 elec susp)	26670	-	-	"PK188" / "MK319"	⊥ ○	26671 !	-	-	"PK313"	⊥ ○
407											
3/06-10	407 Coupe 2.2, 2.7 Hdi, 3.0 (301 elec susp)	-	-	-	"PK313" / "MK324" (301 2.2)	⊥ ⊕	-	-	-	-	⊥ ⊕
4007											
09-10	4007 SUV (VU, VV)	-	72437ST R 72438ST L	-	PK342 / MK333 (MK4 bearings)	⊥ ⊕	61455	37310ST >	-	PK396	⊥ ⊕ No s/pan
4008											
12-16	4008 SUV	68353 R 68354 L	-	-	MK333	⊥ ⊕	61321	-	-	-	⊥ ⊕ S/pan unit
504											
70-85	504 Sedan (301 1800L)	"MR916"	-	-	-	⊥ ⊕	"R5418"	-	-	-	⊥ ⊕ Check OE # prior to ordering
76-85	504 Sedan 1800L	"MR916"	-	-	-	⊥ ⊕	"R5410"	-	-	-	⊥ T
504											
74-80	504 S/Wagon (Imported Strut)	"MR916"	-	-	-	⊥ ⊕	-	-	-	-	⊕ ⊕
80-85	504 S/Wagon (Local Strut)	"MR205"	-	-	-	(Check dimensions prior to ordering)	-	-	-	-	⊕ ⊕
505											
80-85	505 Sedan (Local Strut)	"MR999"	-	-	"PK024"	(Check dimensions prior to ordering)	"R5418"	-	-	-	⊥ ⊕
508											
11-18	508 sedan gen 1 (W23, 8D)	-	"742192SP" R "742193SP" L	-	"MK329R" & "MK330L" (301 bearings)	⊥ ⊕	-	"376154SP"	-	"PK313"	⊥ ○
5008											
11-14	5008 1.6 THP MPV gen 1 (T8)	-	"742110SP" R "742111SP" L	-	"PK124" / "MK395"	⊥ ⊕	-	"376097SP"	-	-	○ ○
17-on	5008 1.6T MPV gen 2 (P87, MC, MJ, MR, M4)	-	742287SP	-	PK434 / MK433 (301 bearings)	⊥ ⊕	-	376264SP	-	-	⊥ ⊕
607											
01-07	607 3.0 V6 (301 elec susp)	-	"742122SP" R "742123SP" L	-	"MK182"	⊥ ⊕	-	"376221SP"	-	-	○ ○
806											
96-Sept'97	806 MPV	"V4201"	-	-	"PK122" / "MK269R" & "MK270L"	⊥ ⊕	"V5006"	-	-	-	⊕ ⊕
Oct'97-'02	806 MPV	"V4201"	-	-	"PK122" / "MK269R" & "MK270L"	⊥ ⊕	"V2510"	-	-	-	⊕ ⊕
807											
03-08	807 MPV 2.2 Hdi	"G8601" R "G8602" L	-	-	"MK269R" & "MK270L"	⊥ ⊕	"G2247"	-	-	-	○ ○

Key

*	See important installation information on inside front cover
!	Excluding self-levelling suspension
...	Special order - phone 010 900 1850. 6-12 week waiting period

~	Imported
#	Internal bump stop
⊕	Steering damper

- It is recommended that all new shock absorbers are fitted in pairs
- Do not mix gas and non-gas units on the same axle
- **Bold** part numbers indicate heavy-duty shocks
- Underlined part numbers indicate parts not immediately available
- *Italic* part numbers followed by > indicate parts to be discontinued

Passenger and light commercial

Part number [alphabetical listing]

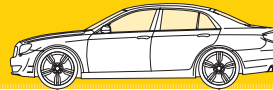

Year	Application	Front					Rear				
		Entry shocks	Premium shocks	Springs	Protection kits/ Mounting kits	Mounting information	Entry shocks	Premium shocks	Springs	Protection kits/ Mounting kits	Mounting information
PEUGEOT continued											
Boxer											
99-06	Boxer Van 1.4 ton SWB gen 2	V4501	—	—	"PK074" / "MK308R" & "MK309L" bearings) OR	Check OE #'s for correct shocks / Check year & Vin for correct MK	V2507	—	—	—	Check OE #'s
99-06	Boxer Van 1.8 ton LWB gen 2	V4410	—	—	"PK074" / "MK147R" & "MK148L" bearings)	Check OE #'s for correct shocks / Check year & Vin for correct MK	V2509	—	—	—	Check OE #'s
April '06-on	Boxer 2.2 Hdi, 3.0 Hdi Van LWB gen 3 (120, 140, 160, 200) 3.3 & 4.0 ton 4x4	V4512 OR	—	—	PK285 / MK308R & MK309L bearings)	V4512 Piston rod OD = 25mm, can also check OE #'s	V2130 (Check OE lengths) OR	—	—	PK457	V2130 = Closed: 283mm, Open: 418mm
	(Check front piston rod OD, and rear open and closed lengths for correct shock selection)	V4513	—	—	—	V4513 Piston rod OD = 28mm, can also check OE #'s	V2131 (Check OE lengths) OR	—	—	—	V2131 = Closed: 315mm, Open: 476mm
			—	—	—	—	V2132 (Check OE lengths)	—	—	—	V2132 = Closed: 293mm, Open: 444mm
Expert / Tepee											
09-14	Expert Panel Van 2.0 Hdi 1 Tepee MPV gen 2	"G8167" "G8168"	—	—	"MK269R" (right) & "MK270L" (left)		"V2517"	—	—	—	
Landtrek											
21-on	Landtrek 1,9TD LCV 4x2 & 4x4	—	—	—	—	—	—	—	—	—	—
Partner											
99-Nov'02	Partner Grand Raid MPV 2.0 Hdi (DW10TD) gen 1 (600kg payload) (5F)	R8001 R8002	—	—	PK006 / MK001 (bearing only) OR "MK097" (mounting & bearing)	Check OE #'s	43104	—	—	—	Check OE #'s
Nov'02-08	Partner Grand Raid MPV 1.9D (DW8B) & 2.0 Hdi (DW10TD) gen 1 (600kg payload) (5F)	G8007 G8008	—	—	PK006 / MK001 (bearing only) OR "MK097" (mounting & bearing)	Check OE #'s	43104	—	—	—	Check OE #'s
09-18	Partner 1.6, 1.6Hdi Tepee 8 seater gen 2 (B9)	G7323 G7324	—	—	"PK124" / "MK196"	Check OE #'s	G1118	—	—	—	Check OE #'s
Partner											
99-11/02	Partner Panel Van 1.9D gen 1 (800kg payload)	R8001 R8002	—	—	PK006 / MK001 (bearing only)	Check OE #'s	43104	—	—	—	Check OE #'s
11/02-08	Partner Panel Van 1.9D gen 1 (800kg payload)	G8007 G8008	—	—	PK006 / MK001 (bearing only)	Check OE #'s	43104	—	—	—	Check OE #'s
09-18	Partner 1.6, 1.6Hdi panel van gen 2, 800 – 1000kg payload (B9)	G7323 G7324	—	—	"PK124" / "MK196"	Check OE #'s	G1118	—	—	—	Check OE #'s
19-on	Partner panel van 1.2T, 1.5Hdi, 1.6Hdi gen 3, 1000kg payload (K9)	G8653	—	—	MK433 bearings)		G2257	—	—	—	

Key	
*	See important installation information on inside front cover
!	Excluding self-levelling suspension
"..."	Special order – phone 010 900 1850. 6-12 week waiting period

~	Imported
#	Internal bump stop
	Steering damper

- It is recommended that all new shock absorbers are fitted in pairs
- Do not mix gas and non-gas units on the same axle
- **Bold** part numbers indicate heavy-duty shocks
- Underlined part numbers indicate parts not immediately available
- *Italic* part numbers followed by > indicate parts to be discontinued

Passenger and light commercial

Part number [alphabetical listing]

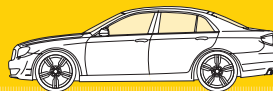

Year	Application	Front					Rear				
		Entry shocks	Premium shocks	Springs	Protection kits/ Mounting kits	Mounting information	Entry shocks	Premium shocks	Springs	Protection kits/ Mounting kits	Mounting information
PORSCHE											
924											
76-88	924 Turbo, Carrera GT & S (EXCL sealed struts)	"MR969"	—	—	—	Cartridge only	—	—	—	—	
944											
81-88	944 Turbo (EXCL sealed struts)	"MR969"	—	—	—	Cartridge only	—	—	—	—	—
Cayenne											
03-10	Cayenne 4x4 SUV (9PA)	—	<i>D0303</i> > D0303R / D0304L	"MK341" (EXCL bearings)	—	(Btm U brkt) s/pan unit	—	<i>D8072</i> > D8072S !	—	"MK341" (EXCL bearings)	S/pan unit
11-17	Cayenne 4x4 SUV (92A)	—	—	"MK341" (EXCL bearings)	—	—	—	—	—	"MK341" (EXCL bearings)	—
11-17	Cayenne 4x4 SUV (9YA)	—	—	—	—	—	—	—	—	—	—
Macan											
14-on	Macan 4x4 SUV (95B)	—	—	—	—	—	—	—	—	"MK388" (EXCL bearings)	—
PROTON											
Arena											
06-12	Arena 1.5i 1/2 ton LDV	—	—	—	—	—	—	—	—	—	—
Gen 2											
05-14	Gen 2 1.6 (EXCL models with ABS)	—	—	—	—		—	—	—	—	S/Seat uni
Savvy											
06-09	Savvy 1.2 Hatch	—	—	—	—	—	—	—	—	—	—
X50											
22-on	X50 1,5T SUV	—	—	—	—	—	—	—	—	—	—
X70											
22-on	X70 1,5T SUV	—	—	—	—	—	—	—	—	—	—
X90											
23-on	X90 1,5T SUV	—	—	—	—	—	—	—	—	—	—
RAMBLER											
Hornet											
70-76	Hornet & Sportabout	—	—	—	—		"R5410"	—	—	—	
Ranger											
68-73	Sedan All	V1063	—	—	—		"R3216" ~	—	—	—	
68-73	S/Wagon All	V1063	—	—	—		<i>GA2057</i> >	—	—	—	
RENAULT											
5											
74-85	R5 All	"R3248"	—	—	—		"R3741"	—	—	—	 Do not allow the susp to hang on installation
9 & 11											
Mid 83-86	R9 & R11 All	"11036"	—	—	"PK029" (Boots only) / MK001 (bearing only)		"R3724"	—	—	—	

Key

*	See important installation information on inside front cover
!	Excluding self-levelling suspension
"..."	Special order – phone 010 900 1850. 6-12 week waiting period

~	Imported
#	Internal bump stop
	Steering damper

- It is recommended that all new shock absorbers are fitted in pairs
- Do not mix gas and non-gas units on the same axle
- **Bold** part numbers indicate heavy-duty shocks
- Underlined part numbers indicate parts not immediately available
- *Italic* part numbers followed by > indicate parts to be discontinued

Passenger and light commercial

Part number [alphabetical listing]

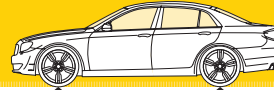

Year	Application	Front					Rear				
		Entry shocks	Premium shocks	Springs	Protection kits/ Mounting kits	Mounting information	Entry shocks	Premium shocks	Springs	Protection kits/ Mounting kits	Mounting information
RENAULT continued											
Captur											
13-19	Captur 0.9T, 1.2T, 1.5dci crossover SUV gen 1 (J87, J5, H5)	—	D0501S	"SP4125"	PK392 / MK418 [UNCL] bearings		—	D7023S	"SP4130"	PK314	⊥ ⊕
20-on	Captur 1.0, 1.3T crossover SUV gen 2 (HF, JB, JE)						G1430				⊥ ⊕
Clio II											
99-13	Clio 1.2 [UNCL] Va Va vroom [EXCL] 1.2 16v, 1.4 & 1.6, 2.0 & 3.0 V6)	11272	—	"SE3543"	PK066 / MK100 [UNCL] bearings		23896	—	"SN0430"	PK154	⊥ ⊕
99-06	Clio 1.2 16v, 1.4, 1.5dCi & 1.6 [EXCL] Sport (1.6, 2.0 & 3.0)	11273	—	"SE3545"	PK066 / MK100 [UNCL] bearings		23896	—	"SN0430"	PK154	⊥ ⊕
99-06	Clio 1.6 16v Sport [EXCL] 2.0 16v Sport & 3.0 V6 mid engine)	G7486	—	—	PK066 / MK100 [UNCL] bearings		23896	—	—	PK154	⊥ ⊕
Clio III											
End 06-March '13	Clio 1.4, 1.5dCi & 1.6 [EXCL] : 1.2, 2.0 Sport, R27, 2.0 RS) For 1.2 see Clio II above	G7277	—	"SE3439"	PK153 / MK263R & MK264L [EXCL] bearings & [EXCL] "10"-13 models) & MK347 (bearings only)	 OE# = 8200556694	G1067	—	"SE3440"	PK314	⊥ ⊕
Clio IV											
April'13-19	Clio 0.9, 1.2 [EXCL] Sport susp. RS)	G7277	—	1.2 = "SP4237"	PK392 / MK418 [UNCL] bearings)		G1176	—	1.2 = "SP4127"	PK453	⊥ ⊕
April'13-19	Clio 1.6 RS Sport	—	—	—	/ MK418 [UNCL] bearings)		"G1183A"	—	—	PK453	⊥ ⊕
Clio V											
20-on	Clio 1.0T [EXCL] Sport)		—	—			G1429	—	—		⊥ ⊕
Duster											
13-Sept '18	Duster 4x2 1.6, 1.5dci [EXCL] Auto) gen 1 (HS)	G7372 (Man) / G7373 (Auto)	—	—	PK286 / MK300 [UNCL] bearings)		G1153	—	—	—	⊥ ⊕
13-Sept '18	Duster 4x4 1.6, 1.5dci [EXCL] Auto) gen 1 (HS)	G7372 (Man) / "G7373" (Auto)	—	SP3940	PK286 / MK300 [UNCL] bearings)		G7386	—	SP3939	PK314 / MK300 [UNCL] bearings)	
Oct 18-on	Duster 4x2 1.5dCi & 1.6 gen 2 (HM)	G7372	—	—	PK286 / MK300 [UNCL] bearings)		G1153	—	—	—	⊥ ⊕
Oct 18-on	Duster 4x4 1.5dCi gen 2 (HM)	G7372	—	—	PK286 / MK300 [UNCL] bearings)		G7386	—	—	PK314 / MK300 [UNCL] bearings)	
Espace 2 (J63 / P36)											
94-96	Espace MPV [EXCL] air susp & sealed front struts)	—	—	—	—	⊥ ⊗	"42045"	—	—	—	⊕ ⊕
Espace / Grand Espace 3 (J66 / P52 / D66)											
96-02	Espace (J66 / P52) + Grand Espace (D66) MPV [UNCL] air susp	"G16728"	—	—	"PK029" (Boots only) / "MK152R" + "MK153L"		"42061"	—	—	—	⊕ ⊕
Espace / Grand Espace 4 (JK)											
02-14	Espace + Grand Espace 2.0, 2.2dCi, 3.5 V6 MPV	"G8397"	—	—	"PK165" / "MK199"		"G1363"	—	—	—	⊕ ⊕
Express											
22-on	Express van 1.0		—	—	—			—	—		
Fluence											
11-17	Fluence sedan	"G8267"	—	—	PK190		23967	—	—	—	⊕ ⊕

Key

*	See important installation information on inside front cover
!	Excluding self-levelling suspension
"..."	Special order – phone 010 900 1850. 6-12 week waiting period

~	Imported
#	Internal bump stop
⊕	Steering damper

- It is recommended that all new shock absorbers are fitted in pairs
- Do not mix gas and non-gas units on the same axle
- **Bold** part numbers indicate heavy-duty shocks
- Underlined part numbers indicate parts not immediately available
- *Italic* part numbers followed by > indicate parts to be discontinued

Passenger and light commercial

Part number [alphabetical listing]



Year	Application	Front					Rear				
		Entry shocks	Premium shocks	Springs	Protection kits/ Mounting kits	Mounting information	Entry shocks	Premium shocks	Springs	Protection kits/ Mounting kits	Mounting information
RENAULT continued											
Kadjar											
16-18	Kadjar 1.2, 1.5dCi 4x2 & AWD SUV (HA, HL)	—	D0049R / D0050L				—	D7034 > D7034S			
Kangoo Multix & Express											
June '04-08 (Multix) '01-09 (Express)	Kangoo 1 Multix 1.4 MPV people carrier (580kg payload, 2 rear torsion bars), and Kangoo 1 Express minivan 1.4 & 1.5dCi (750kg payload, 4 rear torsion bars) (EXCL 4x4)	11285	—	—	PK066 / MK100	 (Oil)	43107 (2 rear torsion bars – Multix) / or G55022 > G43152 (4 rear torsion bars – Express)	—	—	—	 Check if 2 or 4 rear torsion bars
08-Nov '20	Kangoo 2 MPV & minivan (Check OE front strut outer diameter & bottom bracket width for correct selection)	R7612	—	—	PK315 / MK326 (INCL) bearings	 (Oil) Strut OD = 47mm & bttm bracket 27mm wide	G1105	—	—	—	 (wheelbase 2697mm or 3081mm)
		G8173	—	—	PK315 / MK326 (INCL) bearings	 (Gas) Strut OD = 52mm & bttm bracket 35mm wide					
Dec 20-22	Kangoo 3 MPV & minivan	Sp order					Sp Order				
Kiger											
21-on	Kiger 1.0, 1.0T SUV		—	—				—	—		
Koleos											
08-13	Koleos 4x4 SUV gen 1 (HY)	—	D0027R / D0028L	—	PK307 / MK334R & MK335L (INCL) bearings		—	D7019S	—	—	
19-on	Koleos 2.5 4x4 SUV gen 2 (HC)			—					—		
Kwid											
16-on (INCL) end '19 facelift)	Kwid 1.0 SUV (BW)	G9076	—	—	—		G3021	—	—	—	
Laguna I											
99-01	Laguna Sedan (B56 / K56) Check front mounting information for correct strut Shock OE#'s 7700830490 = 11743	"11743" or	—	—	"PK029" (Boots only) / "MK154"	 Smaller 14mm camber bolt mntg holes. Camber brkt width 24mm	"G52023"	—	—	—	
	OE#'s 7700830491 or 7700830492 = 11655	"11655"	—	—	"PK029" (Boots only) / "MK154"	 Larger 16mm camber bolt mntg holes. Camber brkt width 34mm					
Laguna I											
95-00	Laguna S/Wagon (B56 / K56)	"11655"	—	—	"PK029" (Boots only) / "MK154"		"G52024"	—	—	—	
Laguna II											
01-07	Laguna II All, (INCL) S/Wagon (X74)	"G7281"	—	—	"PK171" / "MK185" Angled mountings (INCL) bearings	 Angled U/Seat	"43118"	376162SP >	—	—	
Laguna III											
09-14	Laguna III Coupe (X91)	"G8186"	—	—	"PK352" / "MK383" (INCL) bearings		—	—	—	—	

Key

*	See important installation information on inside front cover
!	Excluding self-levelling suspension
...	Special order – phone 010 900 1850. 6-12 week waiting period

~	Imported
#	Internal bump stop
⊕	Steering damper

- It is recommended that all new shock absorbers are fitted in pairs
- Do not mix gas and non-gas units on the same axle
- **Bold** part numbers indicate heavy-duty shocks
- Underlined part numbers indicate parts not immediately available
- *Italic* part numbers followed by > indicate parts to be discontinued

Passenger and light commercial

Part number [alphabetical listing]

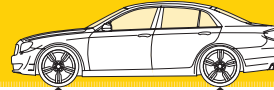

Year	Application	Front					Rear				
		Entry shocks	Premium shocks	Springs	Protection kits/ Mounting kits	Mounting information	Entry shocks	Premium shocks	Springs	Protection kits/ Mounting kits	Mounting information
RENAULT continued											
Logan											
08-12	Logan sedan (U90)	G7203	—	—	PK286 / MK300		23991	—	—	PK314	
For Megane Scenic MPV ... see Scenic											
Megane I											
95-02	Megane Hatch & '96-03 Classic Sedan (EXCL 2.0 16v)	16242	—	SP1730 > (EXCL 2.0)	"PK029" (Boots only) / MK096 (EXCL bearings)		43095	—	—	—	
95-02	Megane Hatch 2.0 16v (EXCL Sedan)	—	—	SP2215 >	MK001 (bearing only)		43093	—	—	—	
Megane I											
96-May04	Megane Coupe (EXCL 2.0 16v)	16242	—	SP1730 > (EXCL 2.0)	"PK029" (Boots only) / MK096 (EXCL bearings)		43093	—	—	—	
96-May'04	Megane Coupe 2.0 16v	—	—	SP2215 >	MK001 (bearing only)		43093	—	—	—	
Megane I											
97-May'04	Megane Cabriolet (EXCL 2.0 16v)	16242	—	—	"PK029" (Boots only) / MK096 (EXCL bearings)		43095	—	—	—	
97-May'04	Megane Cabriolet 2.0 16v	—	—	—	MK001 (bearing only)		—	—	—	—	
For Megane Scenic MPV ... see Scenic											
Megane II											
03-08	Megane II Sedan & Hatch All (EXCL "Shake it" (EXCL 2.0 T Sport)	G16387	—	SP2920 > SE2920 (EXCL 1.9 & 2.0)	PK162 / MK193 (EXCL bearings)		23967	—	SP2918 > SE2918 (EXCL Sedan)	—	OE# = 8200287404
Megane II											
June'04-08	Megane II cc Coupe 1.6, 1.9dCi, 2.0	G16387	—	—	PK162 / MK193 (EXCL bearings)		23967	—	—	—	
June'04-08	Megane II cc Cabriolet 1.6, 1.9dCi, 2.0	G16387	—	—	PK162 / MK193 (EXCL bearings)		23967	—	—	—	
For Megane Scenic MPV ... see Scenic											
Megane III											
09-Aug 16	Megane III Hatch 1.2T, 1.4T, 1.6, 1.9dCi (EXCL 2.0T GT, RS & Sport susp)	G8149	—	SP3905 (1.2) / SP3906 (1.4 & 1.6) / "SP3908" (1.9dCi)	PK190 / MK327 (EXCL bearings)		G1108A	—	"SP3090"	—	
Megane III											
09-Aug 16	Megane III cc Coupe (EXCL Cabriolet & 2.0T GT, & RS)	G8149	—	—	PK190 / MK327 (EXCL bearings)		G1108A	—	—	—	
For Megane Scenic see "Scenic"											
Megane IV											
Sept 16-22	Megane IV Hatch 1.2T, 1.6, (EXCL 2.0T GT & 1.8 RS)	—	"742283SP"	—	MK434 (EXCL bearings)		—	"376257SP"	—	—	
Megane IV											
Sept 16-22	Megane IV Coupe 1.2T, 1.6, (EXCL 2.0T GT & 2.0T RS)	—	—	—	—	—	—	—	—	—	—
Modus											
05-08	Modus 1.2, 1.4, 1.6 Hatch / mini MPV	G7277	—	—	PK153 / MK263R & MK264L		G1067	—	—	PK314	

Key

*	See important installation information on inside front cover
!	Excluding self-leveling suspension
"..."	Special order – phone 010 900 1850. 6-12 week waiting period

~	Imported
#	Internal bump stop
⊕	Steering damper

- It is recommended that all new shock absorbers are fitted in pairs
- Do not mix gas and non-gas units on the same axle
- **Bold** part numbers indicate heavy-duty shocks
- Underlined part numbers indicate parts not immediately available
- *Italic* part numbers followed by > indicate parts to be discontinued

Passenger and light commercial

Part number [alphabetical listing]

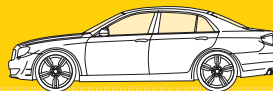

Year	Application	Front					Rear				
		Entry shocks	Premium shocks	Springs	Protection kits/ Mounting kits	Mounting information	Entry shocks	Premium shocks	Springs	Protection kits/ Mounting kits	Mounting information
RENAULT continued											
Oroch											
End '23-on	(Duster) Oroch LCV	–	–	–	–		–	–	–	–	
Safrane											
96-'00	Safrane	"11741"	–	–	"PK029" (Boots only) / MK001 (bearing only)		"R11172"	–	–	–	
Sandero & Stepway											
09-Feb'14	Sandero hatch (EXCL Stepway) (B90 / BS gen 1)	G7203	–	–	PK286 / MK300 (INCL bearings)		23991	–	–	–	⊥ ○
09-Feb'14	Sandero Stepway (BS gen 1)	94204EA	–	–	PK286 / MK300 (INCL bearings)	 (Tenneco Argentina)	83840EA	–	–	–	⊥ ○ (Tenneco Argentina)
March '14-20	Sandero 0.9 hatch (EXCL Stepway) (B8 gen 2)	G7456 (std ht)	–	–	PK286 / MK496 (INCL bearings)		G1225	–	–	–	⊥ ○
March '14-20	Sandero 0.9 Stepway (B8 gen 2)	G7457	–	–	PK286 / MK496 (INCL bearings)		83840EA	–	–	–	⊥ ○ (Tenneco Argentina)
Scenic I											
96-Feb'04	Scenic 1.4 & 1.6 Manual (EXCL RX4)	16242	–	<i>SP0135</i> > "SE0135"	"PK029" (Boots only) / MK096 (INCL bearings)	 Small s/pan	G55019	–	–	–	⊖ ⊖
96-June'98	Scenic 1.6 Automatic, 1.9dCi, 2.0 (EXCL RX4)	"G16259"	–	"SP1726" >	"PK029" (Boots only) / MK096 (INCL bearings)		G55019	–	–	–	⊖ ⊖
June'98-Feb'04	Scenic 1.6 Automatic, 1.9dCi, 2.0 (EXCL RX4)	16242	–	"SP1726" >	"PK029" (Boots only) / MK096 (INCL bearings)	 Small s/pan	G55019	–	–	–	⊖ ⊖
01-04	Scenic RX4 4x4	–	–	–	–	–	–	"376110SP"	–	–	⊖ ⊖
Scenic II & Grand Scenic II											
March'04-end 09	Scenic II 1.6, 1.9dCi, 2.0	G7396	–	1.6 = "SP2896", 1.9 & 2.0 = "SP2895"	PK162 / MK193 (INCL bearings)		G1337	–	"SP2899"	–	⊖ ⊙
Sept'04-end 09	Grand Scenic II (LWB) 1.9dCi, 2.0	G7396	–	"SP2895"	"PK159" / MK193 (INCL bearings)		"G1338"	–	"SP2898"	–	⊖ ⊙
Scenic III											
end 09-16	Scenic III MPV 1.6, 1.9dCi	<u>G8377</u>	–	"SP4004" EXCL 1.6)	PK190 / MK327 (INCL bearings)		G1337	–	"SP4005"	–	⊥ ⊙
end 09-16	Grand Scenic III (LWB) 1.9dCi	<u>G8377</u>	–	"SP4004"	PK190 / MK327 (INCL bearings)		"G1338" (firmer)	–	"SP4006"	–	⊖ ⊙
Trafic											
03-14	Trafic 1.9 Dci panel van gen 2 (X83)	V4504	–	"SN2783"	PK116 / MK181 (INCL bearings)		V1167	–	"SP2784" LWB 3.5m OR "SP2787" SWB 3.0m	–	⊖ ⊖
End14-on	Trafic 2.0TD panel van gen 3 (X82, FG)	V4520	–	–	/MK181 (INCL bearings)		V1167	–	–	–	⊖ ⊖
Triber											
20-on	Triber mini SUV / MPV – 7 seater & Express van 1.0	–	–	–	–	–	–	–	–	–	–
Twingo											
08-13	Twingo hatch 1.2, 1.5TD . gen 2, EXCL RS Sport (CNO)	R7610	–	–	PK066 / MK100		G1101A	–	–	–	⊥ ○

Key

*	See important installation information on inside front cover
!	Excluding self-levelling suspension
"..."	Special order – phone 010 900 1850. 6-12 week waiting period

~	Imported
#	Internal bump stop
⊖	Steering damper

- It is recommended that all new shock absorbers are fitted in pairs
- Do not mix gas and non-gas units on the same axle
- **Bold** part numbers indicate heavy-duty shocks
- Underlined part numbers indicate parts not immediately available
- *Italic* part numbers followed by > indicate parts to be discontinued

Passenger and light commercial

Part number [alphabetical listing]

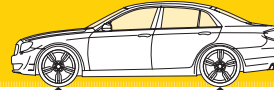

Year	Application	Front					Rear				
		Entry shocks	Premium shocks	Springs	Protection kits/ Mounting kits	Mounting information	Entry shocks	Premium shocks	Springs	Protection kits/ Mounting kits	Mounting information
ROVER											
2600 & 3500 SD1											
78-84	2600 & 3500 SD1	—	—	—	—		—	—	—	—	⊥ T
25											
03-05	25 Hatch	—	—	—	—		"23945"	—	—	—	⊥ ○ S/pan unit
75											
01-05	75 Sedan	"G8619" "G8620"	—	—	"PK132"		"G1369"	"E1301" > / "G1369"	—	"PK082"	⊥ ○
SAAB											
900											
94-98	900 Sedan & Convertible	"G8326"	—	—	"MK006"		"G1308"	—	—	—	⊥ ⊕
9000											
87-97	9000CD, CS, CDE & CSE	"16539"	—	—	"MK081"		"43079" !	—	—	—	⊥ ⊕
9.3											
98-02	9.3 2.0 & 2.2TiD sedan & coupe	"MG278"	—	—	"PK080" / "MK006"		"G1308"	—	—	—	⊥ ⊕
98-02	9.3 Convertible	"MG278"	—	—	"PK080" / "MK006"		"G1308"	—	—	—	⊥ ⊕
03-10	9.3 Sedan 1.9TiD, 2.0 and 2.0T	"G8290" "G8291"	—	—	"PK318" / "MK208" mounting & "MK342" bearing		"G1371"	—	—	Check OE #'s	⊥ ⊕
9.5											
97-01	9.5 sedan & S/W	—	"742158SP"	—	"MK006"		—	"376126SP" !	—	—	⊥ ⊕
01-10	9.5 sedan & S/W	—	"742124SP"	—	"MK268"		—	"376126SP" !	—	—	⊥ ⊕
SEAT											
Altea											
06-10	Altea Mini MPV OE Strut leg outer diam = 50mm	GT8058	—	—	PK163 / MK194	 (Strut OD 50mm)	GT2210	—	—	—	⊥ ⊕
	OE Strut leg outer diam = 55mm	"G8399"	—	—	PK163 / MK194	 (Strut OD 55mm)					
Ibiza											
06-08	Ibiza Hatch & Sedan	G78023 > G78123	G42052SP >	—	PK012 / MK156		GT1003	—	—	MK203	⊥ ⊕
Leon											
06-08	Leon Hatch OE Strut leg outer diam = 50mm	GT8058	—	—	PK163 / MK194	 (Strut OD 50mm)	GT2210	—	—	MK203	⊥ ⊕
	OE Strut leg outer diam = 55mm	"G8399"	—	—	PK163 / MK194	 (Strut OD 55mm)					
SMART											
ForFour											
End 04-07	ForFour 1.3 Pulse & 1.5 Passion (W454 gen 1)	G7363 G7364	—	—	"MK366"		G1099	—	—	"PK304"	⊥ ○
14-on	ForFour 0.9 & 1.0 gen 2 Brabus (W453 gen 2)	—	"742271SP"	—	"MK418"		—	"376242SP"	—	—	⊥ ○

Key

*	See important installation information on inside front cover
!	Excluding self-levelling suspension
"..."	Special order – phone 010 900 1850. 6-12 week waiting period

~	Imported
#	Internal bump stop
⊕	Steering damper

- It is recommended that all new shock absorbers are fitted in pairs
- Do not mix gas and non-gas units on the same axle
- **Bold** part numbers indicate heavy-duty shocks
- Underlined part numbers indicate parts not immediately available
- *Italic* part numbers followed by > indicate parts to be discontinued

Passenger and light commercial

Part number [alphabetical listing]

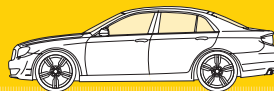

Year	Application	Front					Rear				
		Entry shocks	Premium shocks	Springs	Protection kits/ Mounting kits	Mounting information	Entry shocks	Premium shocks	Springs	Protection kits/ Mounting kits	Mounting information
SMART continued											
ForTwo											
03-07	ForTwo all 700cc cabrio Brabus (W450 gen 1)	G7086	–	–	"PK349" / "MK344"		G1080	–	–	"PK350"	○ ○
08-14	ForTwo all 1.0 cabrio Brabus (W451 gen 2)	G7104	–	–	"PK388" / "MK344"		"43133"	–	–	–	⊥ ○
End14-on	ForTwo all 1.0 cabrio Brabus (W453 gen 3)	–	"742271SP"	–	–		–	"376242SP"	–	–	⊥ ○
Roadster											
End 03-07	Roadster Passion Cabriolet & Roadster Pure & Pulse Coupe	G7086	–	–	"MK396"		G1080	–	–	–	○ ○

SSANGYONG											
Actyon / Actyon Sports											
06-11	Actyon SUV	–	–	–	–	–	–	–	–	–	–
11-19	Actyon Sports double cab 4x2 & 4x4 LDV	–	–	–	–	–	–	–	–	–	–
Korando											
98-08	Korando K230EL, K320EL & K290TDi 4x4 (KJ) gen 2	–	<i>D7704 > D7704S</i>	–	–	⊥ ⊕	–	<i>D7640 > D7640S</i>	–	–	⊥ ○
Korando (C200)											
11-19	Korando 2.0 4x2 & 4x4 (C200) gen 3	–	–	–	–	–	–	–	–	–	–
20-on	Korando (C300) gen 4	–	–	–	–	–	–	–	–	–	–
Kyron											
06-12	Kyron 4x4 SUV with independent rear susp 4x2 = special order	–	<i>D7009 > D7009S</i>	–	–	⊥ ⊗	–	<i>D9004 > D9004A > (independent Axle)</i>	–	–	⊥ ⊕ (IRS)
Musso											
95-06	Musso 602TDi, E230EL, E320EL 4x4	M5464	–	–	–	⊥ ⊕	M4464	–	–	–	⊥ ○
Musso Sport											
04-05	Musso Sport D/C LDV	M5464	–	–	–	⊥ ⊕	–	–	–	–	–
Rexton											
02-06	Rexton I & II 270, 290TD, E320 4x4 SUV (Y200)	–	<i>D7009 > D7009S</i>	–	–	⊥ ⊗	–	D8021S	–	–	⊥ ○
07-12	Rexton I & II 270, 290TD, E320 4x4 SUV (Y250)	–	<i>D7009 > D7009S</i>	–	–	⊥ ⊗	–	<i>D8020 > D8020S</i>	–	–	⊥ ⊕
12-17	Rexton W RX270Xdi, 4x2 & 4x4 SUV (Y290)	–	–	–	–	–	–	–	–	–	–
18-on	Rexton SUV (Y400)	–	–	–	–	–	–	–	–	–	–
Stavic											
06-13	Stavic SV270, SV320 MPV	–	–	–	–	–	–	–	–	–	–

SUBARU											
BRZ											
12-16	BRZ 2.0 coupe	–	–	–	–	–	–	–	–	–	–
Crosstrek											
22-on	Crosstrek SUV	–	–	–	–	–	–	–	–	–	–
Forester											
98-May02	Forester 1 AWD 2.0 & 2.5 Self leveling, elec or air susp) (SF gen 1)	"16483" "16484"	–	–	"PK321"		–	<i>71410 > 71411 > !</i>	–	"MK290R" & "MK291L"	shocks with rear canister attached)
June 02-04	Forester 2 AWD 2.5 Self leveling, elec or air susp) (SG gen 2)	–	–	–	–		–	–!	–	–	

Key

*	See important installation information on inside front cover
!	Excluding self-leveling suspension
"..."	Special order – phone 010 900 1850. 6-12 week waiting period

~	Imported
#	Internal bump stop
⊕	Steering damper

- It is recommended that all new shock absorbers are fitted in pairs
- Do not mix gas and non-gas units on the same axle
- **Bold** part numbers indicate heavy-duty shocks
- Underlined part numbers indicate parts not immediately available
- *Italic* part numbers followed by > indicate parts to be discontinued

Passenger and light commercial

Part number [alphabetical listing]

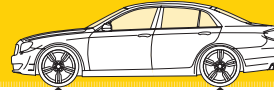

Year	Application	Front					Rear				
		Entry shocks	Premium shocks	Springs	Protection kits/ Mounting kits	Mounting information	Entry shocks	Premium shocks	Springs	Protection kits/ Mounting kits	Mounting information
SUBARU continued											
Forester continued											
05-08	Forester 2 AWD 2.5 (300) Self leveling, elec or air susp) (SG gen 2)	—	72426ST R > 72426ST L >	—	—	⚙	—	—!	—	—	⚙ Check OE#'s
08-13	Forester 3 AWD 2.0D, 2.5 (300) Self leveling, elec or air susp) (SH gen 3)	—	—	—	—	⚙	—	—!	—	—	⚙
14-Nov 18	Forester 4 AWD 2.0, 2.5 (300) Self leveling, elec or air susp) (SJ gen 4)	—	—	—	—	⚙	—	—!	—	—	⚙
Dec 18-on	Forester 4 AWD 2.0 (300) Self leveling, elec or air susp) (SK gen 5)	—	—	—	—	—	—	—!	—	—	—
Impreza											
92-01	Impreza 1 AWD 1.8 & 2.0 (300) Air susp, GT Turbo Sport/ WRX Sti and Outback) (GC/GF/GM/GFC)	"G16479" R "G16480" L	—	—	—	⚙	"G16701" R "G16702" L	—	—	"MK260"	⚙
02-03	Impreza 2 AWD 2.0 & 2.5 (300) Sti, S/W and Outback) (GD)	—	—	—	—	⚙	—	—	—	—	⚙
04-07	Impreza 2 AWD 2.0 & 2.5 (300) WRX Sti, S/W and Outback) (GD)	—	—	—	—	⚙	—	—	—	—	⚙
08-12	Impreza 3 AWD 2.0, 2.5 (300) 2.5 WRX Sti, S/W, Air susp and Outback) (GE/GR/GH)	—	—	—	—	⚙	—	—	—	—	⚙
16-on	Impreza 5 AWD 2.0 (300) 2.5 WRX Sti, S/W, Air susp and Outback) (GK, GT)	—	—	—	—	—	—	—	—	—	—
Legacy											
92-93	Legacy I 4x4 (300) Air susp) (BC/BF/BJ)	—	—	—	—	⚙	"G16701" R "G16702" L	—	—	—	⚙
94-96	Legacy II 4x4 (300) Air susp, 3.0 & Outback) (BD/BG/BK)	"G16479" R "G16480" L	—	—	—	⚙	"G16701" R "G16702" L	—	—	—	⚙
96-99	Legacy II Facelift 4x4 (300) Air susp, 3.0 & Outback) (BD/BG/BK)	"G16479" R "G16480" L	—	—	—	⚙	—	—	—	—	⚙
00-04	Legacy III 2.0 & 2.5 4x4 (300) Air susp, 3.0 & Outback) (BE/BH)	"16491" R "16492" L	—	—	—	⚙	—	71354ST	—	"MK289"	⊥ ⊕ S/pan unit
05-09	Legacy IV 2.0 & 3.0 4x4 (300) Air susp & Outback) (BL/BP)	—	—	—	—	⚙	—	—	—	"MK289"	⊥ ⊕ S/pan unit
10-12	Legacy V 2.0 & 2.5 4x4 (300) Air susp & Outback) (BM/BR)	—	—	—	—	⚙	—	—	—	—	⊥ ⊕ S/pan unit
13-14	Legacy V Facelift 2.0 & 2.5 4x4 (300) Air susp & Outback) (BM/BR)	—	—	—	—	—	—	—	—	—	—
14-19	Legacy VI 3.6 (300) Air susp & Outback) (BN/BS)	—	—	—	—	—	—	—	—	—	—
20-on	Legacy VII 3.6 (300) Air susp & Outback) (...)	—	—	—	—	—	—	—	—	—	—
Legacy Outback											
99-04	Legacy Outback AWD (BH) gen 2 (300) Self leveling or elec susp	—	—	—	—	⚙	—	—	—	—	⚙
05-09	Legacy Outback 2.5, 3.0 AWD (BP) gen 3 (300) Self leveling or elec susp	—	—	—	—	⚙	"G2132" !	—	—	"MK289"	⊥ ⊕ S/pan unit
10-12	Legacy Outback 2.5, 3.0 AWD (BR) gen 4 (300) Self leveling or elec susp	—	72686ST R > 72687ST L >	—	—	⚙	—	—	—	—	⊥ ⊕ S/pan unit
13-14	Legacy Outback 2.5, 3.0 AWD (BR) gen 4 facelift (300) Self leveling or elec susp	—	—	—	—	⚙	—	73039ST >	—	—	⊥ ⊕ S/pan unit
15-19	Legacy Outback 2.5, 3.6 AWD gen 5	—	—	—	—	—	—	—	—	—	—
20-on	Legacy Outback AWD gen 6	—	—	—	—	—	—	—	—	—	—
Tribeca											
07-13	Tribeca B9 SUV 3.6 4x4 (WX)	—	—	—	—	⚙	—	—	—	—	⚙
XV											
12-on	XV SUV 2.0 (WX)	—	—	—	—	⚙	—	—	—	—	⊥ ⊕ S/pan unit

Key

*	See important installation information on inside front cover
!	Excluding self-levelling suspension
"..."	Special order – phone 010 900 1850, 6-12 week waiting period

~	Imported
#	Internal bump stop
⊕	Steering damper

- It is recommended that all new shock absorbers are fitted in pairs
- Do not mix gas and non-gas units on the same axle
- **Bold** part numbers indicate heavy-duty shocks
- Underlined part numbers indicate parts not immediately available
- *Italic* part numbers followed by > indicate parts to be discontinued

Passenger and light commercial

Part number [alphabetical listing]

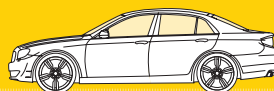

Year	Application	Front					Rear				
		Entry shocks	Premium shocks	Springs	Protection kits/ Mounting kits	Mounting information	Entry shocks	Premium shocks	Springs	Protection kits/ Mounting kits	Mounting information
SUZUKI											
Alto											
09-15	Alto hatch 1.0 gen 7 (GF)	"G9511" R "G9512" L	—	—	—		G1246	—	—	—	○ ○
Baleno											
16-April 22	Baleno hatch 1.4 (WB)	G7911 R G7912 L	—	—	—	 For OE # 41601M68P10 or 41601M68P00 (EX) models with raised ground clearance)	G1377	—	—	—	⊥ ⊕ For OE #'s 4181053R00 or 41800M68P00
May 22-on	Baleno hatch 1.5 (WB facelift)		—	—	—			—	—	—	
Brezza / Vitara Brezza											
21-23	Vitara Brezza 1.5 SUV gen 1 (YF)		—	—	—			—	—	—	
24-on	Brezza 1.5 SUV gen 2 (YH)		—	—	—			—	—	—	
Carry											
85-On	Carry "1/2 Loaf" SK 408, SK410	"V4001" R "V4002" L	—	—	—		—	—	—	—	⊕ ⊕
Celerio											
15-22	Celerio hatch 1.0 gen 2 (FE)	G9513 R G9514 L	—	—	—		G1272	—	—	—	⊥ ⊕
23-on	Celerio hatch 1.0 gen 3		—	—	—			—	—	—	
Ciaz											
15-on	Ciaz 1.4, 1.5 sedan (VC)		—	—	—			—	—	—	
DZire											
18-on	Dzire sedan 1.2 (gen 3)	G7986 R G7987 L	—	—	—		G1377	—	—	—	⊥ ⊕
Eeco microvan											
23-on	Eeco 1.2 microvan		—	—	—			—	—	—	
Ertiga											
14-Feb 19	Ertiga 1.4 7 seater MPV gen 1 (ZE)		—	—	—	(OE # 41068M60M52)		—	—	—	
March 19-on	Ertiga 1.4, 1.5 7 seater MPV gen 2 (NC)		—	—	—			—	—	—	
Fronx											
23-on	Fronx 1.5 crossover SUV		—	—	—			—	—	—	
For Grand Vitara ... see Vitara											
Ignis											
17-on	Ignis crossover 1.2 SUV gen 2 (MF, FF21S)		—	—	—			—	—	—	
For older Jimny ... see SJ / Samurai											
Jimny											
98-Sept 18	Jimny SN413 (Rear Coil spring susp) JA33, JB33	—	D7705S	"SP2099"	—	⊥ ⊕ No s/pan Check OE #'s: D7705 = 4160081A10 / 4160081A11	—	D7706S	"SP2100"	—	○ ○ Check OE #'s D7706 = 4170081A00 / 4170081A01
Oct 18-on	Jimny 1.5 (JB64, JB74, A6G) 3 & 5 door		—	—	—			—	—	—	
Kizashi											
11-15	Kizashi sedan (FR)		—	—	—			—	—	—	

Key

*	See important installation information on inside front cover
!	Excluding self-levelling suspension
"..."	Special order – phone 010 900 1850. 6-12 week waiting period

~	Imported
#	Internal bump stop
⊕	Steering damper

- It is recommended that all new shock absorbers are fitted in pairs
- Do not mix gas and non-gas units on the same axle
- **Bold** part numbers indicate heavy-duty shocks
- Underlined part numbers indicate parts not immediately available
- *Italic* part numbers followed by > indicate parts to be discontinued

Passenger and light commercial

Part number [alphabetical listing]



Year	Application	Front					Rear				
		Entry shocks	Premium shocks	Springs	Protection kits/ Mounting kits	Mounting information	Entry shocks	Premium shocks	Springs	Protection kits/ Mounting kits	Mounting information
SUZUKI continued											
S-Presso											
20-on	S-Presso 1.0 SUV (FL)		–	–	–			–	–	–	
SJ / Samurai / Jimny											
81-87	SJ410, SJ413, SJ413-4, (leaf spring susp), Samurai 4X4		<i>D7029</i> > <i>D7029S</i>	–	–	⊥ ○	–	"D8443S"	–	–	○ ○
	Steering Damper ⊕	SC2941 ⊕			SA1999 Protective boot	⊖ ⊖					
88-04	Samurai SJ413, 4X4 (Leaf spring susp)		<i>D7029</i> > <i>D7029S</i>	–	–	⊥ ○ No s/pan	–	"D7014S"	–	–	○ ○
	Steering Damper ⊕	SC2941 ⊕			SA1999 Protective boot	⊖ ⊖					
For newer Jimny ... see Jimny											
Splash											
14-16	Splash 1.2 hatch	<i>G7273</i> <i>G7274</i>	–	–	"PK343" / "MK639"		G1131	–	–	–	PK340 ⊥ ○
Swift											
08-10	Swift gen 1 (RS413, RS415, MZ, EZ) AWD & Sport ZC31S	<i>G7273</i> <i>G7274</i>	–	–	"PK343" / "MK369"		G1131	–	–	–	PK340 ⊥ ⊖
11-18	Swift 1.2, 1.4 gen 2 (AZ6, FZ, NZ, ZC72S, ZC82S) 1.6 Sport ZC32S & 4WD	<i>G7451</i> <i>G7452</i>	–	"SP4001"	MK421		G1214A	–	"SP4015"	–	⊥ ⊖ (OE# = 4180068L00)
18-on	Swift 1.2 gen 3 (A2L, AZ) 1.4T Sport rear	<i>G7986</i> <i>G7987</i>	–	–	–	 (1.4T Sport)	G1377	–	–	–	⊥ ⊖ 1.4T Sport)
Super Carry											
16-on	Super Carry 3/4 ton LCV 1.2	–	–	–	–	–	–	–	–	–	–
SX4											
End'08-March'14	SX4 2.0 4x2 SUV OE raised susp (GY, EY, RW)	–	–	–	PK289 / MK498 (bearings)		G1116 (check OE #s)	–	–	–	⊥ ⊖ For OE#'s 4180079J00 / 4180079J01 / 4180079J20 / 4180079J21 / 4180079J22 (incr ground clearance)
End'08-March'14	SX4 2.0 4x4 SUV (GY, EY, RW)	<i>G7511</i> <i>G7512</i>	–	–	PK289 / MK498 (bearings)		G1116 (check OE #s)	–	–	–	⊥ ⊖ For OE#'s 4180079J00 / 4180079J01 / 4180079J20 / 4180079J21 / 4180079J22
April'14-17	SX4 1.6 4x2 & 4x4 S-Cross SUV (JY)	<i>G8626</i> <i>G8627</i>	–	–	–		–	<i>376259SP</i>	–	–	⊥ ⊖
For Vitara Brezza ... see Brezza											
Vitara / Grand Vitara											
89-99	Vitara (SWB) 2 doors 4X4 gen 1 (ET, TA)	–	"D0201" > "D0201S"	–	–		–	"D7624S"	–	–	⊥ ⊖
91-99	Vitara (LWB) 4 doors 4X4 gen 1 (ET, TA)	–	"D0201" > "D0201S"	–	–		–	"D7633" > "D7633S"	–	–	⊥ ⊖
15-on	Vitara 4x4 1.4T, 1.6 gen 4 (LY)	<i>G8626</i> <i>G8627</i>	–	–	–		–	<i>376259SP</i>	–	–	⊥ ⊖
Grand Vitara											
98-04	Grand Vitara 4x4 XL gen 2 (FT, GT)	–	D0202R / D0203L	–	MK356 (bearings)		–	D7644S	–	–	⊥ ⊖
03-04	Grand Vitara XL 4x4 gen 2 std SWB	–	"D0015R" / "D0016L"	–	MK356 (bearings)		–	"D7015S"	–	–	⊥ ⊖
05-20	Grand Vitara 4x4 2.4i, 3.2i gen 3 (JT)	–	D0029R / D0030L	–	PK324 / MK497 (bearings)		–	D7020S	–	–	⊖ ⊖
22-on	Grand Vitara 4x4 1.5 gen 4 (YM)	–	–	–	–	–	–	–	–	–	–
XL6											
23-on	XL6 1,5 Crossover 6 seater MPV (NC)	–	–	–	–	–	–	–	–	–	–

Key

*	See important installation information on inside front cover
!	Excluding self-levelling suspension
"..."	Special order – phone 010 900 1850, 6-12 week waiting period

~	Imported
#	Internal bump stop
⊕	Steering damper

- It is recommended that all new shock absorbers are fitted in pairs
- Do not mix gas and non-gas units on the same axle
- **Bold** part numbers indicate heavy-duty shocks
- Underlined part numbers indicate parts not immediately available
- *Italic* part numbers followed by > indicate parts to be discontinued

Passenger and light commercial

Part number [alphabetical listing]

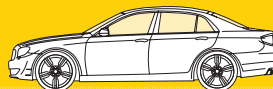

Year	Application	Front					Rear				
		Entry shocks	Premium shocks	Springs	Protection kits/ Mounting kits	Mounting information	Entry shocks	Premium shocks	Springs	Protection kits/ Mounting kits	Mounting information
TATA											
Bolt											
15-19	Bolt hatch & sedan 1.2	–	–	–	–		–	–	–	–	
Indica											
04-16	Indica Hatch (V2) gen 1 B-Line (Check front OE #'s, and if or ABS)	–	–	–	–	 (OE#'s = 88103019 & 88103020) 22mm rod OD	G1060	–	–	–	 S/pan unit
Indica Vista											
Sept 08-16	Indica Vista Hatch gen 2 (V3) B-Line	G8265 > G8266 >	–	–	–		G1221	–	–	–	
Indigo											
04-10	Indigo Sedan and S/Wagon (Check front OE #'s, and if or ABS)	–	–	–	–	 (OE# for ABS models = 90105029 / 27753210012)	–	–	–	–	 (OE# for ABS models = 2386570406 / 282832400117 / 277532400158)
Manza											
11-16	Manza sedan	–	–	–	–		–	–	–	–	
Safari											
07-11	Safari SUV 4x4	–	–	–	–		–	–	–	–	
	Steering Damper	R2777 ~									
11-14	Safari SUV 4x4	–	–	–	–		–	–	–	–	
Super Ace Pick-up											
12-on	Super Ace 1 ton drop side LCV 1.4	G8260 G8261	–	–	–	 (Ind)	R7275	–	–	–	 (Ind)
Telcoline											
04-16	Telcoline 2.0 4x2 & 4x4 LDV 3.0 Diesel Worker	M8354	RS999039 *16 (Re-use bottom mounting OE sleeve)	–	–	 *16 If top stud is too short, remove washer 2nd from the top (under the top rubber)	M6902	RS999116	–	–	
	Steering Damper	R2777 ~									
For Vista models ... see Indica Vista											
Xenon											
07-19	Xenon 4x2 & 4x4 LDV (excludes models with front top eye mountings)	M8354	RS999039 *16 (Re-use bottom mounting OE sleeve)	–	–	 (No s/pan) *16 If top stud is too short, remove washer 2nd from the top (under the top rubber)	M6902	RS999116	–	–	
	Steering Damper	R2777 ~									
TOYOTA											
86											
12-20	86 Coupe (ZN6/ZC6) GR	–	–	–	–		–	–	–	–	
Auris											
07-March '13	Auris 1.4, 1.6, 1.8, 2.0 hatch [E150 / 330N] TRD	G8119 G8120 ~	–	1.4, 1.6, 1.8 = SP3718, 2.0 = "SP3719"	PK181 / MK331 (bearings)		G1095	–	(All) SP3720	PK415	
April '13-19	Auris (E180)	G8119 G8120 ~	–	1.3 & 1.8 = SP4232	PK181 / MK331 (bearings)		G1095	–	–	PK415	
Avanza											
06-11	Avanza 1.3, 1.5 MPV & Panel Van & ABS (F600) Gen 1 facelift	G7398 G7399	–	–	–	 tyres wider than 185)	GT1069 ~	D7021S !	–	–	 (IN)

Key

*	See important installation information on inside front cover
!	Excluding self-levelling suspension
"..."	Special order – phone 010 900 1850. 6-12 week waiting period

~	Imported
#	Internal bump stop
	Steering damper

- It is recommended that all new shock absorbers are fitted in pairs
- Do not mix gas and non-gas units on the same axle
- **Bold** part numbers indicate heavy-duty shocks
- Underlined part numbers indicate parts not immediately available
- *Italic* part numbers followed by > indicate parts to be discontinued

Passenger and light commercial

Part number [alphabetical listing]

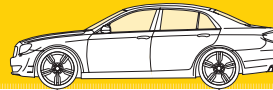

Year	Application	Front					Rear				
		Entry shocks	Premium shocks	Springs	Protection kits/ Mounting kits	Mounting information	Entry shocks	Premium shocks	Springs	Protection kits/ Mounting kits	Mounting information
TOYOTA continued											
Avanza continued											
12-on	Avanza 1.3, 1.5 MPV & Panel Van INCL ABS (F650) Gen 2 INCL facelift	744004SP R 744005SP L	—	—	—	smaller s/pan (CN)	378003SP	—	—	—	(CN)
Avensis											
06-09	Avensis 2.0, 2.0D, 2.2D, 2.4 (T250)	G8091 R G8092 L	—	—	PK146 / MK241 INCL bearings)	Rod may look slightly shorter due to an internal rebound spring	G2119	—	—	—	
Aygo											
11-Sept'15	Aygo hatch gen 1 (AB10)	G7019 R G7020 L	—	—	PK178 / MK351 INCL bearings)		G1075	—	—	PK333 / MK471 EXCL bearings)	
Oct'15-21	Aygo hatch gen 2 (AB40) EXCL Agya models	G7019 R G7020 L	—	"SP4299" with panarame roof, or "SP4300" without panarame roof	PK178 / MK351 INCL bearings)		G1075	—	"SP4301" with panarame roof, or "SP4302" without panarame roof	PK333 / MK421	
C-HR											
17-23	C-HR 1.2T Cross-over Coupe (AX10)	G8813 R G8814 L	—	—	—		G1386	—	—	—	
Camry											
93-Late 97	Camry (RSA mnf) V30, XV10 gen 3	GT8035 R GT8036 L	—	—	—	Bolted s/pan - not INCL (re-use OE s/pan)	GT8033 R GT8034 L	—	—	—	
Late 97-Aug'01	Camry (RSA mnf) V30, XV10 gen 3	GT8038 R GT8039 L	—	—	—	Welded s/pan INCL bearings)	GT8033 R GT8034 L	—	—	—	
96-01	Export Camry (Japan mnf) SXV20, MCV20, XV20 gen 5	16820 R 16821 L	—	—	—		G16822 R G16823 L	—	—	"MK223" INCL bearings)	
Sept'01-06	Camry (Australian mnf) ACV30, ACV31, ACV36, MCV30, MCV36, XV30 gen 6	GT8072 R GT8073 L	—	—	MK224 INCL bearings)		GT8074 R GT8075 L	—	—	MK223 INCL bearings)	
Carri											
98-06	Conquest Carri Panel Van	GT8046 R GT8047 L	—	—	PK026 (Bump rubbers only) / MK088		GT7242 R GT7243 L	—	—	PK023 / MK179 (R) & MK180 (L)	
Celica											
All	Celica & Supra (Special order 8 week lead time: supply year, model code, shock OE #, engine size, if AWD, if turbo)	—	Special order - phone 010 900 1850	—	—	—	—	Special order - phone 010 900 1850	—	—	—
Condor											
Mid 00-05	Condor 4x2	GT2028	—	—	—		GT2031	—	—	—	
Mid 00-05	Condor 4x4	M5464 / GT2084	—	—	—		M8038 / GT2008	—	—	—	
Corolla / Conquest / Tazz / Run X / Quest											
74-Mid 80	Corolla (Imported Strut) (KE)	GT0104	—	—	—		<i>GA2057</i> >	—	—	—	
Mid 80-85	Corolla Sedan R.W.D. (Local Strut) (KE70, AE70)	GT0104	—	—	—		GT2015	—	—	—	
82-88	Corolla S/Wagon & Panelvan R.W.D. (KE71, KE72, KE73)	GT0104	—	—	—		42022	—	—	—	
84-88	Corolla sedan, Avante & Conquest F.W.D. - EXCL Twin Cam (E80)	GT7218 R GT7219 L	—	—	PK026 (Bump rubbers only)		GT7005 R GT7006 L	—	—	PK023	
Mid 85-88	Corolla sedan, Avante & Conquest F.W.D. - Narrow head Twin Cam (E80)	GT7226 R GT7227 L	—	—	PK026 (Bump rubbers only)		GT7005 R GT7006 L	—	—	PK023	
89-96	Corolla & Conquest INCL Twin Cam & 1800 F.W.D P140 (EE90, AE92, CE90)	GT8046 R GT8047 L	—	1.3 = SP0772, 1.6 & 1.8 = SP2186 (SP0772 11mm shorter than SP2186)	PK026 (Bump rubbers only) / MK088 INCL bearings)		GT7242 R GT7243 L	—	SP3161	PK023 / MK179R & MK180L EXCL bearings)	

Key	
*	See important installation information on inside front cover
!	Excluding self-leveling suspension
"..."	Special order - phone 010 900 1850, 6-12 week waiting period

~	Imported
#	Internal bump stop
	Steering damper

- It is recommended that all new shock absorbers are fitted in pairs
- Do not mix gas and non-gas units on the same axle
- **Bold** part numbers indicate heavy-duty shocks
- Underlined part numbers indicate parts not immediately available
- *Italic* part numbers followed by > indicate parts to be discontinued

Passenger and light commercial

Part number [alphabetical listing]

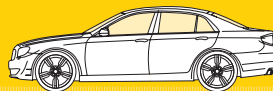

Year	Application	Front					Rear				
		Entry shocks	Premium shocks	Springs	Protection kits/ Mounting kits	Mounting information	Entry shocks	Premium shocks	Springs	Protection kits/ Mounting kits	Mounting information
TOYOTA continued											
Corolla / Conquest / Tazz / Run X / Quest continued											
96-Oct02	Corolla Sedan P160 gen 7 Rsi & Rxi (E100, AE101)	GT8042 GT8043	—	—	PK026 (Bump rubbers only) / MK088 (bearings)		GT7244 GT7245	—	SP0457 > (Rsi & Rxi)	PK023 / MK179R & MK180L (bearings)	 Re-use OE brackets
96-June'06	Conquest / Tazz (EE90, AE92)	GT8046 GT8047	—	1.3 = SP0772, 1.6 & 1.8 = SP2186	PK026 (Bump rubbers only) / MK088 (bearings)		GT7242 GT7243	—	SP3161	PK023 / MK179R & MK180L (bearings)	
Nov'02-Sept'07	Corolla Sedan & RunX Hatch Verso MPV, TRD) gen 9 (E120 & E121)	GT8021 GT8022	742238SP > 742239SP >	1.4 & 1.6 = SP3505, 1.8 RunX = SP3506	PK113 (Bump rubber only) / MK296 (bearings)		GT1013	—	SP3508	PK326 / MK294 (bearings)	 S/pan unit
Nov'02-Sept'07	"Bubble" Corolla Sedan & Hatch Cross border export mkt Verso MPV, TRD) 1NZ	—	—	—	—		GT1013	—	—	PK326 / MK294 (bearings)	 S/pan unit
Oct '07-13	Corolla Sedan 1.4, 1.6, 1.8, 2.0D gen 10 (E140, E150, E152)	G8119 G8120	—	1.4 = SP3717, 1.6 = SP3718, 2.0D = "SP3719"	PK146 / MK331 (bearings)		G1095	—	SP3720	—	
06-12	Corolla Axio & Fielder S/W (E140 narrow body jap model) Cross border export mkt	GT8272 GT8273	—	—	—	 (not for RSA)	GT1013	—	—	—	 S/pan unit
Feb 14-19	Corolla Sedan 1.3, 1.4D, 1.6, 1.8 gen 11 "Professional" Quest (E170 / E180)	G8119 G8120	—	—	PK438 / MK331 (bearings)		G1095	—	SP3720	PK415	
13-on	Corolla Axio & Fielder S/W (E160 narrow body jap model) Cross border export mkt	—	—	—	—	 (not for RSA)	—	—	—	—	—
March 20-on (hatch from 2019)	Corolla Sedan & Hatch 1.8, 1.8 hybrid, 2.0 gen 12 (E210) Quest & Cross	—	—	—	—	—	—	—	—	—	—
For Corolla Verso ... see Verso											
Corolla Cross											
21-on	Corolla Cross 1.8, 1.8 hybrid SUV (XG10) Sedan & Hatch	—	—	—	—	—	—	—	—	—	—
Corolla Quest											
14-19	Corolla QUEST 1.6 gen 10 (E140, E150)	G8119 G8120	—	1.6 = SP3718	PK146 / MK331 (bearings)		G1095	—	SP3720	PK415	
Feb 19-on	Corolla QUEST 1.8, gen 11 (E170, E180)	G8119 G8120	—	—	PK438 / MK331 (bearings)		G1095	—	SP3720	PK415	
Corolla Van											
73-79	Corolla Van (Imported Strut)	—	—	—	—		42022	—	—	—	
79-88	Corolla Van	GT0104	—	—	—		42022	—	—	—	
Corona Mk I											
64-74	Corona (MKI)	GT2010	—	—	—		GA2057 >	—	—	—	
74-80	Corona (MKI)	GT2010	—	—	—		GT2015	—	—	—	
Corona MkII											
69-73	RT 62 1900 (MKII)	GT2010	—	—	—		GT2008	—	—	—	
72-78	2000 (MKII)	GT2010	—	—	—		GA2057 >	—	—	—	
Corona											
64-73	Corona MKI & MKII LDV	GT2010	—	—	—		GT2008	—	—	—	
Cressida											
78-81	Cressida Sedan	—	—	—	—		GT2015	—	—	—	

Key

*	See important installation information on inside front cover
!	Excluding self-leveling suspension
"..."	Special order - phone 010 900 1850. 6-12 week waiting period

~	Imported
#	Internal bump stop
⊕	Steering damper

- It is recommended that all new shock absorbers are fitted in pairs
- Do not mix gas and non-gas units on the same axle
- **Bold** part numbers indicate heavy-duty shocks
- Underlined part numbers indicate parts not immediately available
- *Italic* part numbers followed by > indicate parts to be discontinued

Passenger and light commercial

Part number [alphabetical listing]

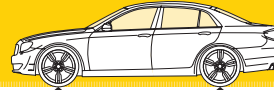

Year	Application	Front					Rear				
		Entry shocks	Premium shocks	Springs	Protection kits/ Mounting kits	Mounting information	Entry shocks	Premium shocks	Springs	Protection kits/ Mounting kits	Mounting information
TOYOTA continued											
Cressida continued											
Mid'81- Mid'86	Cressida Sedan (3.0) 2,8 I.R.S.)	GT0120 >	-	-	-	⌋	GT2015	-	-	-	⊥ ○
84-85	Cressida 2,8 GLI 6 (I.R.S.)	GT0120 >	-	-	-	⌋	GT2022	-	-	-	⊥ ○
86-92	Cressida Sedan (3.0) I.R.S.)	GT0115	-	-	-	⌋	GT2015	-	-	-	⊥ ○
86-92	Cressida 2,8 & 3,0 (& All I.R.S.)	GT0115	-	-	-	⌋	GT2022	-	-	-	⊥ ○
Cressida											
78-81	Cressida S/Wagon	-	-	-	-	⌋	GA2056 >	-	-	-	⊥ ○
Mid'81-85	Cressida S/Wagon	GT0120 >	-	-	-	⌋	42022	-	-	-	⊥ ○
86-92	Cressida S/Wagon	GT0115	-	-	-	⌋	42022	-	-	-	⊥ ○
Etios & Etios Cross											
12-20	Etios 1.5 Etios Cross (AK10)	G7479	-	-	-	⌋ (Ind)	G1248	-	-	-	⊥ ⊕ (Ind)
14-20	Etios Cross 1.5	G7479	-	-	-	⌋ (Ind) (slightly shorter than OE)	G1248	-	-	-	⊥ ⊕ (Ind) (Btm bushing sleeve is slightly narrower than OE)
FJ Cruiser											
11-on	FJ Cruiser	-	RS999777	-	-	⊥ ⊕ S/pan unit	-	RS999305	-	-	⊥ ○
Fortuner											
March 06-March 16	Fortuner SUV 3.0TD & 4.0 V6 4x4 and 4x2 High Rider gen 1 (AN50 / AN60)	M8066	RS999782	-	-	⊥ ⊕ S/pan unit	M8067	RS999354	-	-	⊥ ○
April 16-on	Fortuner SUV 2.4GD, 2.7, 2.8GD, 3.0TD & 4.0 V6 4x4 and 4x2 High Rider gen 2 (AN150/AN160) Std height	M8352	RS55783D (non adj)	-	-	⊥ ⊕ S/pan unit	M8353	RS55357C (non adj)	-	-	⊥ ○
	Raised +-40mm		RS55783F (non adj)	RS40014	+30mm lift		RS55357D (non adj)	RS40051			+40mm lift
Harrier Cross border											
Feb 03-13	Harrier XU30 gen 2	-	"72211ST" R > "72212ST" L >	-	-	⌋	-	-	-	-	⌋
Hi-Ace Minibus / Taxi											
69-83	Hi-Ace SWB Minibus (H20, H30, H40)	-	-	-	-	⊥ ⊕	GT2008	-	-	-	○ ○
84-88	Hi-Ace SWB Minibus (H50)	GT2025 / M8046	-	-	-	⊥ ⊕	23443	-	-	-	○ ○
88-93	Hi-Ace SWB Minibus (H50)	GT2025 / M8046	-	-	-	⊥ ⊕	GT2096	-	-	-	○ ○
85-93	Hi-Ace LWB 16 Seater Minibus / Taxi (H50)	M8046 / GT2025	-	-	-	⊥ ⊕	M8048 / GT2096	-	-	-	○ ○
Mid 93-97	Hi-Ace SWB Minibus (H50)	GT2084 / M5464	-	-	-	⊥ ⊕	M8048 / GT2096	-	-	-	○ ○
Mid 93-10	Hi-Ace LWB 16 Seater Minibus, Super 16 & Siyaya Taxi (H50)	M5464 / GT2084	-	-	-	⊥ ⊕	M8048 / GT2096	-	-	-	○ ○
19-on	Hi-Ace Ses'fikile 16 seater taxi & 14 Seater minibus (gen 5 H200)	M8047 / GT2094	-	-	-	⊥ ⊕	M8074 / GT2102	-	-	-	○ ○
Hi-Ace Panelvan											
69-83	Hi-Ace SWB Panelvan	-	-	-	-	⊥ ⊕	GT2008	-	-	-	○ ○
84-88	Hi-Ace SWB Panelvan	GT2025 / M8046	-	-	-	⊥ ⊕	23443	-	-	-	○ ○
85-93	Hi-Ace LWB Panelvan	M8046 / GT2025	-	-	-	⊥ ⊕	M8048 / GT2096	-	-	-	○ ○
Mid 93-10	Hi-Ace LWB Panelvan	M5464 / GT2084	-	-	-	⊥ ⊕	M8048 / GT2096	-	-	-	○ ○

For Hi-Ace gen 5 (H200) & gen 6 (H300)-See Quantum

Key

*	See important installation information on inside front cover
!	Excluding self-levelling suspension
"..."	Special order - phone 010 900 1850. 6-12 week waiting period

~	Imported
#	Internal bump stop
⊕	Steering damper

- It is recommended that all new shock absorbers are fitted in pairs
- Do not mix gas and non-gas units on the same axle
- **Bold** part numbers indicate heavy-duty shocks
- Underlined part numbers indicate parts not immediately available
- *Italic* part numbers followed by > indicate parts to be discontinued

Passenger and light commercial

Part number [alphabetical listing]

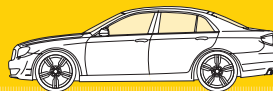

Year	Application	Front					Rear				
		Entry shocks	Premium shocks	Springs	Protection kits/ Mounting kits	Mounting information	Entry shocks	Premium shocks	Springs	Protection kits/ Mounting kits	Mounting information
TOYOTA continued											
Hilux Pick-up											
69-83	Hilux 4x2 N10, N20, N30, N40)	GT2010	-	-	-	⊥ ⊕	GT2008	-	-	-	○ ○
79-84	Hilux 4x4 N30, N40)	M5454	RS999136	-	-	⊥ ⊕	M8042 >	RS999116	-	-	○ ○
	Steering Damper ⊕	SC2914 ⊕			SA1999 S/D Protective boot	○ T					
84-End'98	Hilux All 4x2 (N50, N60)	GT2023 / M5468	-	-	-	⊥ ⊕	GT2024 / M4441	-	-	-	○ ○
84-End'98	Hilux All 4x4 (N505, N60) Standard susp	M5454	RS999136	-	-	⊥ ⊕	M4445	RS999144	-	-	○ ○
	Raised +-20 to 40mm	"AU161702"	-	-	-	⊥ ⊕ 50mm longer than OE	M4445	-	-	-	○ ○ 20mm longer than OE
	Steering Damper ⊕	SC2914 ⊕			SA1999 S/D Protective boot	○ T					
End 98- May 05	Hilux P690 4x2 IFS raised body gen 6 (N140, N150, N160, N170)	GT2035 / M5468	-	-	-	⊥ ⊕ No s/pan	GT2036 / M4441 (firmer ride)	-	-	-	○ ○
End 98- May 05	Hilux P690 All 4x4 & raised body 4x2 Raider IFS gen 6 (N140, N150, N160, N170)	M6432 / GT2045	RS999145	-	-	⊥ ⊕ No s/pan	M4445 / GT2046	RS999144	-	-	○ ○
	Raised +-60mm		RS999136	-	-	Raised 70mm		RS999143	-	-	Raised +-40mm (eye size ID is 0.5mm smaller than OE)
	Steering Damper ⊕	SC2947 o	-		SA1999 S/D Protective boot	○ ⊗ (OE # 45700-39046)					
June 05- Jan 16	HiLux / Vigo std ht 4x2, gen 7 (AN10, AN20, AN30)	GT2091 R GT2092 I	-	-	-	⊥ ⊕ S/pan unit	GT2093	-	-	-	○ ○
June 05- Jan 16	HiLux / Vigo "D4D" 4x4 & Raised body 4x2, gen 7 (AN10, AN20, AN30) Standard height	M8055	RS999782	SP4239	-	⊥ ⊕ S/pan unit	M8056	RS999144	-	-	○ ○
	Raised +-40mm	AU360864 (25mm longer)	-	RS40013 (25mm lift)	-	Raised 40mm Firmer - Designed to be used on vehicles with steel bull bar, extra battery, winch, underbody protection etc. (90kg+ extra front axle load)	AU160865 (40mm longer)	-	-	-	Raised 40mm
	Raised +-50mm		-	-	-		RS999202 (50mm longer)	-	-	-	Raised 50mm
16-on	HiLux "Revo" std ht 4x2, gen 8 (N120, N130)	GT2532 R GT2533 I	-	-	-	⊥ ⊕ S/pan unit	GT2534	-	-	-	○ ○
16-on	HiLux "Revo", "GD6" 4x4 & Raised body 4x2, gen 8, GR Sport (N120, N130) Std height	M8096	RS55783D	-	-	⊥ ⊕ S/pan unit	M8097	RS55355A	-	-	○ ○
	Raised +-40mm		RS55783F	-	-	Lifted +-40mm		RS55143E	-	-	Lifted +-40mm
Innova											
11-15	Innova 2.7 MPV (AN40)	GT2091 R GT2092 I	-	-	-	⊥ ⊕ S/pan unit	-	-	-	-	⊥ ⊕
Ipsium / Picnic / Avensis Verso (Cross border)											
95-01	Ipsium / Picnic 7 seater MPV (XM10)	"G16732" R "G16733" I	-	-	-		"23884"	-	-	-	⊥ ○
02-09	Ipsium / Picnic / Avensis Verso 7 seater MPV (XM20)	-	-	-	-		"G1318"	-	-	-	⊥ ○

Key

*	See important installation information on inside front cover
!	Excluding self-leveling suspension
"..."	Special order - phone 010 900 1850. 6-12 week waiting period

~	Imported
#	Internal bump stop
⊕	Steering damper

- It is recommended that all new shock absorbers are fitted in pairs
- Do not mix gas and non-gas units on the same axle
- **Bold** part numbers indicate heavy-duty shocks
- Underlined part numbers indicate parts not immediately available
- *Italic* part numbers followed by > indicate parts to be discontinued

Passenger and light commercial

Part number [alphabetical listing]

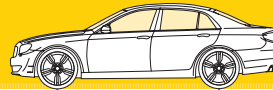

Year	Application	Front					Rear				
		Entry shocks	Premium shocks	Springs	Protection kits/ Mounting kits	Mounting information	Entry shocks	Premium shocks	Springs	Protection kits/ Mounting kits	Mounting information
TOYOTA continued											
Landcruiser Station Wagon											
60											
83-89	Landcruiser 60 series Station Wagon Models #J6# #V... (FJ60, FJ62, HJ60, HJ6) Std Susp	AU161704	RS999354	-	-	⊥ ○ (10mm OD rod & 19mmID rubber bushing)	M4441	RS999341	-	-	○ ○ 16id holes in rubber bushing mnt
	Raised +-30mm to 50mm	AU161704	-	-	-	⊥ ○ 30mm longer than OE		-	-	-	○ ○ 30mm longer than OE
85-87	"Grey" UN Import Landcruiser 60 series FJ60 / FJ62 Station Wagon (Model: #J6# #V...)	M4434	-	-	-	⊥ ○ Shock 25mm longer than std SA models.	-	-	-	-	○ ○ 19.5id holes in rubber bushing mnt
70											
07-on (facelifted in 2024)	Landcruiser 76 & 78 series Station Wagon (Coil front, leaf rear) Std Susp	AU160466	RS999342	-	-	⊥ T Check mountings	M6409	RS999202	-	-	○ ○
	Raised +-30mm to 80mm	-	RS999207 (Raised)	-	-	⊥ T 70mm longer than OE	-	RS999143 (Raised)	-	-	○ ○ 50mm longer than OE
80											
90-98	Landcruiser 80 series Station Wagon . (Not certain solid axle 105 series '98-'07 models) All Standard Susp	AU160894	RS999207	-	-	⊥ T	AU160895	RS999208 / RS999357 (firmer)	"SP0593" (std ht)	-	⊥ ⊕
	Raised +-50mm	-	"RS55210A"	"RS40026" (+50mm)	-	⊥ T 50mm longer than OE	-	"RS55212B"	"RS40027" (+50mm)	-	⊥ ⊕ 50mm longer than OE
	Steering Damper ⊕	SC2946 ⊕ ("SC2916MM" is shorter)	-	-	SA1999 S/D Protective boot	○ ○					
100											
98-07	Landcruiser 100 Series S/Wagon IFS (Not Lexus IFS & Torsion Bars elec susp) Std Height	D8022 > D8022S	RS999358 >	-	-	⊥ ⊕	D8023 > D8023S !	RS999359 ! >	-	-	⊥ ⊕
200											
08-July 20	Landcruiser 200 Series S/Wagon (elec susp) St Height	-	D9012S	-	-	⊥ ⊕ S/pan unit	AU160766	-	-	-	⊥ ⊕
300											
Aug 20-on	Landcruiser 300 Series S/Wagon (elec susp) St Height	-	-	-	-			-	-	-	
Landcruiser Pick-up											
40											
72-86	Landcruiser 40 series LDV leaf springs	AU160192 > / M8039	-	-	-	○ ○	M4441	RS999341 (46mm shorter than OE) OR RS999116 (48mm longer than OE)	-	-	○ ○
	Steering Damper ⊕	SC2946 ⊕ ("SC2916MM" is shorter)	-	-	SA1999 S/D Protective boot	○ ○					
75											
87-99	Landcruiser HZJ75 series LDV leaf springs Standard Susp	M4434	RS999354	-	-	⊥ ○	M6409	RS999202	-	-	○ ○
	Raised +-30 to 50mm	AU161704	-	-	-	⊥ ○ 30mm longer than OE	-	-	-	-	○ ○
	Steering Damper ⊕	SC2946 ⊕ ("SC2916MM" is shorter)	-	-	SA1999 S/D Protective boot	○ ○					

Key

*	See important installation information on inside front cover
!	Excluding self-levelling suspension
"..."	Special order - phone 010 900 1850. 6-12 week waiting period

~	Imported
#	Internal bump stop
⊕	Steering damper

- It is recommended that all new shock absorbers are fitted in pairs
- Do not mix gas and non-gas units on the same axle
- **Bold** part numbers indicate heavy-duty shocks
- Underlined part numbers indicate parts not immediately available
- *Italic* part numbers followed by > indicate parts to be discontinued

Passenger and light commercial

Part number [alphabetical listing]



Year	Application	Front					Rear				
		Entry shocks	Premium shocks	Springs	Protection kits/ Mounting kits	Mounting information	Entry shocks	Premium shocks	Springs	Protection kits/ Mounting kits	Mounting information
TOYOTA continued											
Landcruiser Pick-up continued											
79											
99-on	Landcruiser HZJ79 series LDV Rear leaf springs, Coil front Std Susp	AU160466	RS999342	-	-	⊥ T Check mountings stud OD 13mm	M6409	RS999202	-	-	○ ○
	Raised +-30mm to 80mm	-	RS999207 (Raised)	"RS40037" (+50mm)	-	⊥ T RS999207 70mm longer than OE	-	RS999143 (Raised)	"RS44031" (+50mm)	-	○ ○ 50mm longer than OE
99-07 only	Steering Damper ⊕	SC2946 ⊕			SA1999 S/D Protective boot	○ ○ (99-07 only)					
Lite Ace / Town Ace / Noah											
96-07	Lite Ace / Town Ace / Noah R50 AWD	-	-	-	-		"D4468S"	-	-	-	⊥ T
MR2											
01-07	MR2 cabriolet	-	-	-	-		-	"72502ST" R "72503ST" L	-	-	
Prado											
90-93 (30x)	"Grey" Import Old Prado J70 series S/W '93-'96 (RJ / LJ "Bundera")	-	"D6434S"	-	-	⊕ T (90-May'93 only)	-	"D6435S"	-	-	⊕ T (90-May'93 only)
97-'02	Prado J90 series 3 door SWB S/W (30x) eye/eye rear mountings)	M8077	RS999762	-	-	⊥ ⊕ S/pan unit (reuse OE washers)	D8343 > D8343S	RS999187	SP1948 > (std ht)	-	⊥ ○
97-'02	Prado J95 series 5 door LWB S/W (30x) eye/eye rear mountings)	M8078	RS999762	-	-	⊥ ⊕ S/pan unit (reuse OE washers)	D8343 > D8343S	RS999187	SP1950 > (std ht)	-	⊥ ○
03-Oct '09	Prado J120 (5 door) / J125 (3 door) Series (30x) elec susp) Std Height	D8024S	RS999777	-	-	⊥ ⊕ S/pan unit (Bigger & higher S/pan than earlier model)	D8019S !	RS999357 !	-	-	⊥ ○
	Raised +-30mm to 70mm	AU360837 > (45mm longer)	-	RS40013 > (+40mm)	-	+40mm longer than OE	"AU160891" ! (45mm longer)	-	-	-	+40mm longer than OE
Nov '09-01 '24	Prado J150 (30x) elec susp) 3.0 GRJ150, 4.0 KDJ150 Std Height	D9016 > D9016S	RS55783A	-	-	⊥ ⊕ S/pan unit	D9014S !	RS55357B !	-	-	⊥ ○
	Raised +-40mm	-	"RS55783B"	-	-	+40mm lift	-	"RS55302" !	-	-	+40mm lift
Q2 '24-on	Prado 2,8TD J250 (30x) elec susp) Std Height	-	-	-	-		-	-	-	-	
Previa / Estima (Cross border)											
90-00	Previa std & GL (ABS) Rear IRS TCR 11 & 21 (gen 1 XR10, XR20)	"11592" R "11593" L	-	-	"PK121" / "MK161"		"G22691" >	-	-	-	⊥ T (IRS)
00-05	Previa 2.0 D 4-D, 2.4, 3.0 V6 (4x2) (gen 2 XR30, XR40)	-	-	-	-		"G1319"	-	-	-	⊥ ○
Prius											
00-03	Prius Hybrid (NHW10, XW10, NHW10, NHW11) gen 1	-	72118ST R > 72119ST L >	-	-		-	-	-	-	⊥ ○
04-March '09	Prius Hybrid (NHW20, XW20) gen 2	"G7507" R "G7508" L	-	-	PK113 / MK296		"G2123"	-	-	-	⊥ ○
April '09-May '16	Prius Hybrid (ZWW30, XW30) gen 3	"G8250" R "G8251" L	-	-	-		G1095	-	-	-	⊥ ⊕
June '16-21	Prius Hybrid (XW50) gen 4	-	-	-	-		-	-	-	-	⊥ ⊕
Quantum											
05-19	Quantum 2.5,D, 2.7 Van & Minibus (30x) Ses'fikile taxi (gen 5 Hi-Ace H200) - For the newer 19-on model see Hi-Ace	M8047 / GT2094	-	-	-	⊥ ⊕	M8074 / GT2102	-	-	-	○ ○
19-on	Quantum minibus 11 & 14 seater & van (gen 6 Hi-Ace H300)	-	-	-	-	S/pan unit	-	-	-	-	○ ○

For Run X ... See Corolla / Conquest / Run X

Key

*	See important installation information on inside front cover
!	Excluding self-levelling suspension
"..."	Special order - phone 010 900 1850. 6-12 week waiting period

~	Imported
#	Internal bump stop
⊕	Steering damper

- It is recommended that all new shock absorbers are fitted in pairs
- Do not mix gas and non-gas units on the same axle
- **Bold** part numbers indicate heavy-duty shocks
- Underlined part numbers indicate parts not immediately available
- *Italic* part numbers followed by > indicate parts to be discontinued

Passenger and light commercial

Part number [alphabetical listing]

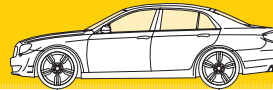

Year	Application	Front					Rear				
		Entry shocks	Premium shocks	Springs	Protection kits/ Mounting kits	Mounting information	Entry shocks	Premium shocks	Springs	Protection kits/ Mounting kits	Mounting information
TOYOTA continued											
RAV4											
95-98	RAV4 Type SXA 10 & 11 (SFI sealed struts & 235/60R 16" wheels) gen 1	—	D0801S	SP0115 (5 door) / "SP3112" (3 door)	MK171		M8075	"D7694S"	SP3109	—	⊥ ○
98-00	RAV4 Type SXA 10 & 11 Seated front struts (SFI 235/60R 16" wheels) gen 1	—	D0009 > D0009R / D0010L	SP0115 (5 door) / "SP3112" (3 door)	MK171		M8075	"D7694S"	SP3109	—	⊥ ○
01-Feb'06	RAV4 (ACA20,21 / ZCA 25, 26 / XA20) gen 2	—	D0011R / D0012L	SP3530	PK386 / MK171		M8075	"D7694S"	SP3528 > SE3528	—	⊥ ○
March '06-12	RAV4 (XA30) gen 3	G8117 R G8118 L	72275ST R > 72276ST L >	SP3830	MK404		—	37289ST	SP3832	—	⊕ ⊖
13-Feb 19	RAV4 (XA40) gen 4	G8117 R G8118 L	72275ST R > 72276ST L >	—	MK404		—	37289ST	—	—	⊕ ⊖
March 19-on	RAV4 (XA50) gen 5	—	—	—	—	—	—	—	—	—	—
Regius / Hi-Ace (Cross border)											
95-99	Regius / Hi-Ace 4x2 RCH12, RCH13, LKH12	"V1108"	—	—	—	⊥ ⊕	"V1140"	—	—	—	○ T
Rumion											
21-on	Rumion MPV 1.5 (NC) based on Suzuki Ertiga	—	—	—	—	—	—	—	—	—	—
Rush											
18-20	Rush SUV gen 3 (F800)	—	—	—	—	—	—	—	—	—	—
For Ses'fikile taxi-See '05-'19 Quantum or '19-on Hi-Ace											
Stallion											
87-01	Stallion LDV & Van	GT2028	—	—	—	⊥ ⊕	GT2006 / M4441	—	—	—	○ ○
Starlet											
89-94	Starlet EP80, EP81, EP82, NP80	"G16161" R "G16162" L	—	—	—		"23313"	—	—	—	⊥ ⊕
94-96	Starlet EP80, EP81, EP82, NP80	"G16161" R "G16162" L	—	—	—		"23315"	—	—	—	⊥ ⊕
96-00	Starlet EP91	"G16251" R "G16252" L	—	—	—		"23853"	—	—	—	⊥ ⊕
20-April '22	Starlet 1.4 gen 1 WB, SZ3 (based on Suzuki Baleno)	G7911 R G7912 L	—	—	—		G1377	—	—	—	⊥ ⊕
May 22-on	Starlet 1.5 gen 2 WB, SZ3 (based on Suzuki Baleno)	—	—	—	—	—	—	—	—	—	—
Stout											
61-79	Stout RK101	—	—	—	—	⊥ ○	M8038	—	—	—	○ ○
79-92	Stout	GT2088 >	—	—	—	⊥ ○	M8038	—	—	—	○ ○
Surf / 4 Runner											
85-March '89	4-Runner & Surf RN61, LN 61 & YN63 4x4 IFS (SFI elec susp (N60)	M6432	—	—	—	⊥ ⊕	M4445	—	—	—	○ ○
	Steering Damper ⊕	SC2947	—	—	—	○ ○	—	—	—	—	—
April'89-95	4-Runner & Surf gen 2 LN130, VZN130 (SFI elec susp, RZN180, RZN185, VZN185 (N120, N130)	M6432	—	—	—	⊥ ⊕ No s/pan	AU161704	—	—	—	⊥ ⊕
	Steering Damper ⊕	SC2947	—	—	—	○ ○	—	—	—	—	—
95-02	4-Runner & Surf Gen 3 (N180)	M8078	RS999762	—	—	⊥ ⊕ S/pan unit	AU160895	RS999208	—	—	⊥ ⊕
09-on	4-Runner & Surf Gen 5 GN5 (N280) (SFI KDSS susp)	—	RS999777	—	—	⊥ ⊕ S/pan unit	—	RS999305 !	—	—	⊥ ⊕
Tazz											
96-June'06	Tazz	GT8046 R GT8047 L	—	—	PK026 (Bump rubbers only)		GT7242 R GT7243 L	—	—	PK023 / MK179 R MK180 L	

Key	
*	See important installation information on inside front cover
!	Excluding self-leveling suspension
"..."	Special order - phone 010 900 1850. 6-12 week waiting period

~	Imported
#	Internal bump stop
⊕	Steering damper

- It is recommended that all new shock absorbers are fitted in pairs
- Do not mix gas and non-gas units on the same axle
- **Bold** part numbers indicate heavy-duty shocks
- Underlined part numbers indicate parts not immediately available
- *Italic* part numbers followed by > indicate parts to be discontinued

Passenger and light commercial

Part number [alphabetical listing]

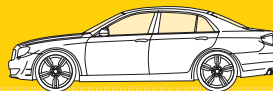

Year	Application	Front					Rear				
		Entry shocks	Premium shocks	Springs	Protection kits/ Mounting kits	Mounting information	Entry shocks	Premium shocks	Springs	Protection kits/ Mounting kits	Mounting information
TOYOTA continued											
TUV											
82-87	TUV LDV	–	–	–	–	⊥ T	GT2008	–	–	–	○ ○
Urban Cruiser											
21-23	Urban Cruiser 1.5 SUV gen 1 (YF) – based on Suzuki Brezza	–	–	–	–		–	–	–	–	
Urban Cruiser Hyryder											
23-on	Urban Cruiser 1.5 SUV (YK/YM) – based on Suzuki Grand Vitara	–	–	–	–		–	–	–	–	
Venture											
91-mid 00	Venture Wagon "Getaway"	GT2028	–	–	–	⊥ ⊕	GT2006 / M4441	–	–	–	○ ○
Verso / Spacio											
04-Oct 09	Corolla Verso MPV (AR10)	G8121 / G8122	–	–	PK325 / MK494 bearings)		G2126	–	"SP3607"	PK326	⊥ ○
Nov 09-12 (2018 in EU)	Corolla Verso MPV (AR20, AUR20, ZCR20)	G8230 / G8231	–	–	–		G2184	–	–	–	⊥ ○
Yaris / Vitz / Platz / Echo											
99-05	Yaris / Vitz Hatch 1.5 T-Sport (Cross border – non RSA) gen 1 (XP10)	G16289	–	"SP3107" (1.0 & 1.3)	"PK133" / MK272 (triangular)		23910	–	"SE1953" (1.0 & 1.3)	"PK147" / MK471	⊥ ○
05-Sept 11	Yaris Hatch & (Vios) Sedan (NBC2) gen 2 (XP90)	G7294 / G7295	–	SP3714 (1.0 & 1.3)	PK351 / MK387 (round)	(CN)	G1074	–	SP3716 (1.0 1.3)	PK333 / MK471	⊥ ○ No top rubbers supplied
Oct 11-19	Yaris Hatch 1.0, 1.3 & Sedan gen 3 (XP130)	G7294 / G7295	–	SP3714 1.5, 1.8 & 1.40)	PK351 / MK387 (round)	(CN) OE # 485100DF60)	G1074	–	SP3716 1.5, 1.8)	PK333 / MK471	⊥ ○ No top rubbers supplied
18-21	Yaris Hatch 1.0, 1.3 & Sedan gen 3 (XP150) "Pulse"		–					–			
22-on	Yaris GR Hatch sport gen 4 (XP210)		–					–			
23-on	Vitz 1.0 Hatch (based on gen 3 Suzuki Celerio)		–					–			

Toyota Lexus ... see Lexus

VOLKSWAGEN

1500 / 1600											
62-69	1500, 1600 Sedan, Variant & Fastback Automatics)	G42058 > / V1034	–	–	–	⊕ ⊕	GT2011	–	–	–	⊕ ⊕
Arteon											
18-22	Arteon 4 door Sport coupe (3H7) Std suspension	–	<u>742269SP</u>	–	MK411 bearings)		–	<u>376246SP</u>	–	PK424 / MK503 bearings)	⊥ ⊕
	Electronic susp	–	<u>C2516S</u>	–	–		–	<u>C1521S</u>	–	–	⊥ ⊕
Amarok											
10-21	Amarok pick-up 4x2 and 4x4 (gen 1)	84751EA	<u>D65353</u> ("Dakar" heavy duty / firm)	–	–	(Arg)	83833EA	<u>D65354</u> ("Dakar" heavy duty / firm)	–	–	⊕ ⊕ (Arg)
22-on	Amarok pick-up 4x2 and 4x4 (gen 2)			–	–				–	–	
Beetle											
52-79	Beetle (Type 1) All Built in RSA Beach Buggy)	GT2074	–	–	–	⊕ ⊕	GT2011	–	–	–	⊕ ⊕
65-03	Beetle (Type 1) Imported, Mexico	"R2578"	–	–	–	⊥ ⊕	GT2011	–	–	–	⊕ ⊕
99-Oct 12	New Beetle (Type 2)	GT8020	–	–	PK076 / MK077		GT1002	–	–	PK078 / MK118	⊥ ⊕

Key

*	See important installation information on inside front cover
!	Excluding self-leveling suspension
"..."	Special order – phone 010 900 1850. 6-12 week waiting period

~	Imported
#	Internal bump stop
⊕	Steering damper

- It is recommended that all new shock absorbers are fitted in pairs
- Do not mix gas and non-gas units on the same axle
- **Bold** part numbers indicate heavy-duty shocks
- Underlined part numbers indicate parts not immediately available
- *Italic* part numbers followed by > indicate parts to be discontinued

Passenger and light commercial

Part number [alphabetical listing]



Year	Application	Front					Rear				
		Entry shocks	Premium shocks	Springs	Protection kits/ Mounting kits	Mounting information	Entry shocks	Premium shocks	Springs	Protection kits/ Mounting kits	Mounting information
VOLKSWAGEN <i>continued</i>											
Beetle <i>continued</i>											
Oct'12-17	New Beetle (Type 2 / A5) 50mm front strut body	GT8058 OR	—	—	PK422 / MK194	 (Check strut body OD)		376241SP OR	—		\perp \ominus (Check rod OD: 11mm rod & 45mm btm eye sleeve)
	55mm front strut body	<i>GT8056 > GT8057</i>	<i>742247SP ></i>	—	PK422 / MK345	 (Check strut body OD)		376240SP	—		\perp \ominus (Check rod OD: 13mm rod & 37mm btm eye sleeve)
CC											
09-17	"Passat" CC AWD 4 Motion Syncro elec elec susp	GT8057	—	—	PK163 / MK194		GT2210 !	—	—	MK203	\perp \circ
09-17	"Passat" CC Elec Susp AWD 4 Motion Syncro	—	<i>C2513S</i>	—	—		—	<i>C1514R & C1517L</i>	—	—	\perp \circ
Caddy											
04-May 15	Caddy All gen 3 (2K) (check front strut OD for correct part) 50mm OD strut tube	<i>G8005 > GT8058</i>	—	<i>SP3287 > SE3287</i>	PK163 / MK194 INCL bearings	 50mm Strut tube OD OE# 1K0413031BA / 1K0413031BB	23990 *15	—	—	PK448 /	\ominus \ominus *15 Appears shorter than OE due to internal rebound spring
	55mm OD Strut tube	<i>GT8056 > GT8057</i>	—	<i>SP3287 > SE3287</i>	PK163 / MK194 INCL bearings	 55mm Strut tube OD OE# 1T0413031.. / 1T0513031...					
June 15-Oct '21	Caddy All gen 3, (2K Facelift)	GT8057	—	:SP4268" = 2.0 EXCL Alltrack	PK163 / MK194 INCL bearings		23990 *15			PK448 /	\ominus \ominus *15 Appears shorter than OE due to internal rebound spring
Nov 21-on	Caddy 1.6i, 2.0Tdi, All INCL Kombi & Cargo, gen 4 (SB)										
For older Caddy bakkie ... see Golf LCV											
For Caravelle ... see Kombi											
For Citi ... see Golf 1											
Crafter											
06-17	Crafter 3 ton and 3.5 ton, EXCL 4x4 & 5 ton (2E/2F)	V4510	—	—	PK302 / MK287 EXCL bearings		V1177	—	—	—	\ominus \ominus Btm eye bushing ID = 12mm
06-17	Crafter 5 ton, EXCL 4x4, 3 ton & 3.5 ton (2E/2F)	V4511	—	—	PK302 / MK287 EXCL bearings		V1178	—	—	—	\ominus \ominus Btm eye bushing ID = 14mm
18-on	Crafter 35, 3 ton and 3.5 ton, EXCL 4x4 & 5 ton (SV/SZ)		—	—				—	—	—	
18-on	Crafter 50, 5 ton, EXCL 4x4, 3 ton & 3.5 ton (SV/SZ)		—	—				—	—	—	
Eos											
07-15	Eos Cabriolet	<i>GT8056 > GT8057</i>	<i>742247SP ></i>	—	PK163 / MK194 INCL bearings		GT2210	<i>376099SP ></i>	—	PK078	\perp \circ
Golf 1 & Citi (Incl Jetta / Fox)											
78-92	Golf 1 / Jetta I & Citi INCL Fox, CTi, ShuttleTrippa & Cabriolet	GT7278	—	SP0024	PK001 / MK070 INCL bearings		GT1011 *8 *9	—	—	PK015	\otimes \ominus S/pan unit
93-10	CITI - EXCL Sonic, Life, VeloCiti & Rox (Sealed Strut)	GT7278	—	SP0024	PK001 / MK070 INCL bearings		GT1011 *8 *9	—	—	PK015	\otimes \ominus S/pan unit
98-10	Citi - Sonic, Life & VeloCiti Slight OE lowering EXCL Rox - shorter rear	GT7278	—	—	PK001 / MK070 INCL bearings		GT1059	—	—	PK015	\otimes \ominus S/pan unit
Golf 2 (Incl Jetta)											
85-93	Golf II & Jetta II	GT7249	—	SP0014 EXCL Gti	PK001 / MK033 INCL bearings		GT1012 *8 *9	—	SP0429 EXCL Gti	PK017 / MK133 EXCL bearings	\otimes \ominus S/pan unit

Key	
*	See important installation information on inside front cover
!	Excluding self-levelling suspension
"..."	Special order - phone 010 900 1850, 6-12 week waiting period

~	Imported
#	Internal bump stop
\oplus	Steering damper

- It is recommended that all new shock absorbers are fitted in pairs
- Do not mix gas and non-gas units on the same axle
- **Bold** part numbers indicate heavy-duty shocks
- Underlined part numbers indicate parts not immediately available
- *Italic* part numbers followed by > indicate parts to be discontinued

Passenger and light commercial

Part number [alphabetical listing]



Year	Application	Front					Rear				
		Entry shocks	Premium shocks	Springs	Protection kits/ Mounting kits	Mounting information	Entry shocks	Premium shocks	Springs	Protection kits/ Mounting kits	Mounting information
VOLKSWAGEN continued											
Golf 3 (Incl Jetta)											
92-94	Golf III & Jetta III (Excl VR6)	GT7249	—	SP0014 (Excl Gti)	PK001 / MK033 (Incl bearings)		GT1012 *8 *9	—	SP0429 (Excl Gti)	PK017 / MK133 (Excl bearings)	⊗ ⊕ S/pan unit
95-99	Golf III & Jetta III (Incl Gti & Cli (Excl VR6)	GT8037	—	1.4 & 1.6 = SP0376, 1.8 = SP0910	PK001 / MK067 (Incl bearings)		GT1012 *8 *9	—	SP0429 (Excl Gti)	PK017 / MK133 (Excl bearings)	⊗ ⊕ S/pan unit
93-99	Golf III & Jetta III VR6	GT8037	—	—	PK001 / MK067 (Incl bearings)		"23976" ~	—	—	PK017 / MK133 (Excl bearings)	⊗ ⊕ S/pan unit
99-04 (Jetta till 2/06)	Golf IV & Jetta IV 1.6 only (Excl Estate S/W) 20mm rod	GT7101	—	SP2090 > SE2090 (Excl Gti, Tdi and 2.3 V5) "SP2082" = Tdi, 2.0, 2.3 / "SP3281" = Gti	PK076 / MK077 (Incl bearings)	 20mm piston rod	GT1002	—	SP0604 > SE0604	PK078 / MK118 (Excl bearings)	⊥ ⊕
99-04 (Jetta till 2/06)	Golf IV & Jetta IV 1.8, Gti Turbo, 1.9 Tdi, 2.0, 2.3 V5 (Excl Estate S/W & 1.6) 22mm rod	GT8020	—	SP2090 > SE2090 (Excl Gti, Tdi and 2.3 V5) "SP2082" = Tdi, 2.0, 2.3 / "SP3281" = Gti	PK076 / MK077 (Incl bearings)	 22mm piston rod	GT1002	—	SP0604 > SE0604	PK078 / MK118 (Excl bearings)	⊥ ⊕
Golf 4											
99-05	Golf IV 1.6 Estate S/Wagon	GT7101	—	—	PK076 / MK077 (Incl bearings)		"23925"	376230SP >	SP0604 > SE0604	PK078	⊥ ⊕
00-05	Golf IV 1.9 Tdi Estate S/Wagon	GT8020	—	—	PK076 / MK077 (Incl bearings)		"23925"	376230SP >	SP0604 > SE0604	PK078	⊥ ⊕
Golf 3 & 4											
93-04	Golf III & IV Cabriolet (Excl 16" wheels)	GT8037	—	—	PK001 / MK033 (Incl bearings)		GT1012 *8 *9	—	—	PK017 / MK133 (Excl bearings)	⊗ ⊕
Golf 5											
04-Feb'09	Golf V (Excl Gti, V5, R32 & Sport susp) 1K1 . OE Strut leg bottom outer diam = 50mm	GT8058	—	1.4 & 1.6 = SE3288, 1.9 & 2.0 = SE3290	PK163 / MK194 (Incl bearing)	 OE Strut leg outer diam = 50mm Check sticker on OE shock: 1K0 412 103 B	GT2210	—	1.4 & 1.6 = SE3292, 1.9 & 2.0 = SP3293	PK078 (round) OR PK353 (Oval) / MK203 (round) OR MK386 (oval), both (Excl) bearings	⊥ ⊕
	OE Strut leg bottom outer diam = 55mm	GT8057	74224ZSP >	1.4 & 1.6 = SE3288, 1.9 & 2.0 = SE3290	PK163 / MK194 (Incl bearing)	 OE Strut leg outer diam = 55mm Check sticker on OE shock: 1T0 412 103 A					
04-Feb'09	Golf V Gti & R32 (Incl) 4 Motion AWD	GT8056 > GT8057	742247SP >	—	PK163 / MK194 (Incl bearing)		GT2210	376099SP >	Gti = "SP3294"	PK078 / MK203 (Excl bearings)	⊥ ⊕
Golf 6											
March '09-13	Golf VI (Excl Gti, V5, R32, AWD, Elec & Sport susp) OE Strut leg bottom outer diam = 50mm	GT8058 !	—	1.2, 1.4, 1.6 = SE3288 (Excl 1.4 auto) / 1.6TDI, 1.8, 2.0 = SE3290 (Incl 1.4 auto)	PK163 / MK194 (Incl bearing)	 OE Strut leg outer diam = 50mm	GT2210 !	—	SE3292	PK078 (round) OR PK353 (Oval) / MK203 (round) OR MK386 (oval), both (Excl) bearings	⊥ ⊕
	OE Strut leg bottom outer diam = 55mm	GT8057	74224ZSP >	1.2, 1.4, 1.6 = SE3288 (Excl 1.4 auto) / 1.6TDI, 1.8, 2.0 = SE3290 (Incl 1.4 auto)	PK163 / MK194 (Incl bearing)	 OE Strut leg outer diam = 55mm					

Key

*	See important installation information on inside front cover
!	Excluding self-levelling suspension
"..."	Special order – phone 010 900 1850. 6-12 week waiting period

~	Imported
#	Internal bump stop
⊕	Steering damper

- It is recommended that all new shock absorbers are fitted in pairs
- Do not mix gas and non-gas units on the same axle
- **Bold** part numbers indicate heavy-duty shocks
- Underlined part numbers indicate parts not immediately available
- *Italic* part numbers followed by > indicate parts to be discontinued

Passenger and light commercial

Part number [alphabetical listing]

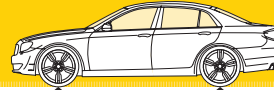

Year	Application	Front					Rear				
		Entry shocks	Premium shocks	Springs	Protection kits/ Mounting kits	Mounting information	Entry shocks	Premium shocks	Springs	Protection kits/ Mounting kits	Mounting information

VOLKSWAGEN *continued*

Golf 6 *continued*

March '09-13	Golf VI Gti & R32 INC1 4 Motion AWD 3XC elec susp	GT8056 > GT8057 !	742247SP > !	1.8, 2.0 = SE3290	PK163 / MK194 INC1 (bearing)		GT2210 !	376099SP > !	SE3292	PK078 / MK203 EXC (bearings)	
March '09-13	Golf VI All Electronic suspension	—	C2513S	1.2, 1.4, 1.6 = SE3288 3XC / 1.4 auto) / 1.6TDi, 1.8, 2.0 = SE3290 INC1 1.4 auto)	—		—	C1514R & C1517L	SE3292	—	

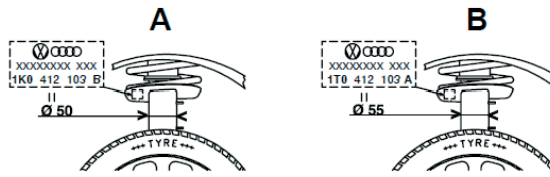

Golf 7

13-19	Golf VII 3XC Gti, V5, R, AWD & Sport susp) (5G) 3XC elec susp) OE Strut leg outer diam = 50mm	—	742116SP !	1.0, 1.2, 1.4 TSi = SP4134 / 1.5, 1.6, 2.0 Tdi = SP4135	PK422 / MK411 INC1 (bearing)	50mm strut OD	!	376193SP ! OR 376194SP ! OR 376195SP !	1.0, 1.2 Tsi = SP4138 / 1.6 TDi = "SP4137" / 1.4 TSi, 2.0 TDi = SP4126	PK424 / MK503 (for OE# 5005133536) OR MK436 with 11mm mounting holes (both 3XC bearings)	
13-19	Golf VII INC1 Gti 3XC V5, R, AWD & Sport susp) (5G) 3XC elec susp) OE Strut leg outer diam = 55mm	—	742117SP !	"SP4136"	PK422 / MK411 INC1 (bearing)	55mm strut OD	!	376193SP ! OR 376194SP ! OR 376195SP !	—	PK424 / MK503 (for OE# 5005133536) OR MK436 with 11mm mounting holes (both 3XC bearings)	
13-19	Golf VII All Electronic suspension (5G)	—	C2516S	—	—		—	C1520S OR C1521S (check bottom mounting sleeve width)	—	—	



Golf 8

20-on	Golf VIII 3XC Gti, V5, R, AWD, Sport susp & Elec susp) OE Strut leg outer diam = 50mm	—	—	—	—	—	—	—	—	—	—
20-on	Golf VIII Gti 3XC V5, R, AWD, Sport susp & Elec susp) OE Strut leg outer diam = 55mm	—	—	—	—	—	—	—	—	—	—
20-on	Golf VII All Electronic suspension	—	—	—	—	—	—	—	—	—	—

Key

*	See important installation information on inside front cover
!	Excluding self-levelling suspension
"..."	Special order - phone 010 900 1850. 6-12 week waiting period

~	Imported
#	Internal bump stop
	Steering damper

- It is recommended that all new shock absorbers are fitted in pairs
- Do not mix gas and non-gas units on the same axle
- **Bold** part numbers indicate heavy-duty shocks
- Underlined part numbers indicate parts not immediately available
- *Italic* part numbers followed by > indicate parts to be discontinued

Passenger and light commercial

Part number [alphabetical listing]

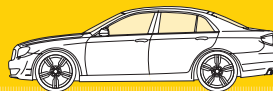

Year	Application	Front					Rear				
		Entry shocks	Premium shocks	Springs	Protection kits/ Mounting kits	Mounting information	Entry shocks	Premium shocks	Springs	Protection kits/ Mounting kits	Mounting information
VOLKSWAGEN continued											
Golf & Citi											
81-09	Golf LDV EXCL old Caddy and Citi Pick-Up	GT7278	—	—	PK001 / MK070 (EXCL bearings)		GT2020	—	—	—	
Golf SV Sportsvan											
15-17	Golf SV (Sportsvan) MPV (EXCL elec susp)		742116SP !	—	PK422 / MK411 (EXCL bearing)	 742116SP = 50mm strut OD	!	376193SP ! OR 376194SP ! OR 376195SP !	PK424 / MK503 (for OE# 500513353G) OR MK436 with 11mm mounting holes (both EXCL bearings)	 376193SP = 11mm rod & 45mm btm sleeve / 376194SP = 13mm rod & 45mm btm sleeve / 376195SP = 13mm rod & 59mm btm sleeve	
13-17	Golf SV All Electronic suspension	—	C2516S	—	—		—	C1521S	—	 C1521S = 59mm btm sleeve	
Jetta – For older Jetta models (ie Jetta 1, 2, 3, 4) see Golf											
Jetta 5											
March'06- Sept'11	Jetta V (EXCL V5 & Sport susp) 1K2 (A5) . Strut leg bottom outer diam = 50mm	GT8058	—	1.6 = SE3288, 1.9 & 2.0 = SE3290	PK163 / MK194 (EXCL bearings)	 50mm strut leg Check sticker on OE shock: 1K0 412 103 B	G2101 > GT2210	376099SP >	1.6 = SE3292, 1.9 & 2.0 = "SP3295"	PK078 (round) OR PK353 (Oval) / MK203 (round) OR MK386 (oval) (both EXCL bearings)	
	OE Strut leg bottom outer diam = 55mm	GT8057 (std susp) / GT8056 > GT8057 (sport susp)	742247SP > (Sport susp)	1.6 = SE3288, 1.9 & 2.0 = SE3290	PK163 / MK194 (EXCL bearings)	 55mm strut leg Check sticker on OE shock: 1T0 412 103 A					
Jetta 6											
Oct'11-19	Jetta VI (EXCL V5 & Sport susp) 1B (A6) . OE Strut leg bottom outer diam = 50mm	GT8058	—	—	PK163 / MK194 (EXCL bearings)	 50mm strut leg	G1220	—	—	PK078 (round) OR PK353 (Oval) / MK203 (round) OR MK386 (oval) (both EXCL bearings)	 11mm Rod, Btm eye width 45mm
	OE Strut leg bottom outer diam = 55mm	GT8057	—	—	PK163 / MK194 (EXCL bearings)	 55mm strut leg	GT2210	—	—	PK078 (round) OR PK353 (Oval) / MK203 (round) OR MK386 (oval) (both EXCL bearings)	 13mm Rod, Btm eye width 37mm
Kombi / Microbus / T2 Caravelle / Transporter / Transporter pick-up (All rear aircooled engines)											
57-68	Kombi, Panelvan & Microbus	GT2074	—	—	—		GT2011	—	—	—	
68-80	Kombi, Panelvan & Microbus (EXCL Fleetline)	GA2058 > / V1034	—	—	—		GA2059 > / V1018	—	—	—	
75-79	Fleetline	GT2074	—	—	—		GT2011	—	—	—	
68-80	Kombi, Microbus Type II Steering Damper	"R1545"	—	—	—		—	—	—	—	

Key

*	See important installation information on inside front cover
!	Excluding self-leveling suspension
"..."	Special order – phone 010 900 1850. 6-12 week waiting period

~	Imported
#	Internal bump stop
	Steering damper

- It is recommended that all new shock absorbers are fitted in pairs
- Do not mix gas and non-gas units on the same axle
- **Bold** part numbers indicate heavy-duty shocks
- Underlined part numbers indicate parts not immediately available
- *Italic* part numbers followed by > indicate parts to be discontinued

Passenger and light commercial

Part number [alphabetical listing]

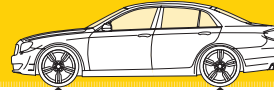

Year	Application	Front					Rear				
		Entry shocks	Premium shocks	Springs	Protection kits/ Mounting kits	Mounting information	Entry shocks	Premium shocks	Springs	Protection kits/ Mounting kits	Mounting information
VOLKSWAGEN <i>continued</i>											
Kombi / Microbus / T3 Caravelle / Transporter / Transporter pick-up (All rear aircooled engines)											
80-03	Kombi, Panelvan, Microbus, Caravelle & Transporter Type III EXCL Syncro 4x4, & Front engined T4)	M8041 *7	-	-	-	⊗ ⊕ *7 ; Use original Equipment Front Top Rubbers	GT2019	-	-	-	⊕ ⊕
85-03	Kombi, Microbus Type III Syncro 4x4 EXCL Front engined T4)	V2401	-	-	-	⊥ ⊕ S/pan Unit	V2505	-	-	-	⊕ ⊕
Kombi / T4 Microbus / Caravelle / Transporter, Transporter pick-up (Front watercooled engine)											
90-July'04	Type IV Caravelle T4 INCL 2.5 Tdi, Transporter & Syncro 4WD (front engine)	V2065	-	-	-	⊥ ⊕	V2077	-	<i>SP0426 > "SN0406"</i>	-	⊕ T
Kombi / Microbus / T5 Caravelle / Transporter											
Aug'04-15	Type V Caravelle, Kombi, Crew bus, Transporter LCV & Van T5 INCL 4Motion 4WD (front engine) EXCL front struts with bottom camber brackets	<u>V4505 > V4522</u>	-	SP3405	PK330 / MK372 INCL bearings)	EXCL OE# 7E8413031 & 7LA413031 with btm camber bracket	V1170	-	SP3408	-	⊕ ⊕
Kombi / Microbus / T6 Caravelle / Transporter van											
16-0n	Type VI T6 Caravelle, California, Kombi, Transporter van, Crew bus & Van INCL 4Motion 4WD EXCL elec susp	<u>V4505 > V4522 !</u>	-	SP3406	PK330 / MK372 INCL bearings)	EXCL OE# 7E8413031 & 7LA413031 with btm camber bracket	V1170 !	-	<u>SN3407</u>	-	⊕ ⊕
16-0n	Type VI All electronic suspension	-	-	"C2517R" & "C2518L"			-	"C1523R" & "C1524L"	-	⊕ ⊕	
LT Series Van											
03-06	LT 28, 32, 35 SWB Van Strut body length 319.5mm	V4503	-	-	PK123 / MK277 EXCL bearings)	Check strut body length. OE #s: start with 901... and 903...; plus 2D0413029 & 2D0413029B	V1116	-	-	-	⊕ ⊕ (Top eye 14mm ID / Btm eye 12mm ID)
	Strut body length 345.5mm	V4507	-	-	PK123 / MK277 EXCL bearings)	Check strut body length . OE #s: Start with 904.... plus 2D0413029A	V1116	-	-	-	
03-06	LT 45, 46 LWB Van Strut body length 319.5mm	V4503	-	-	PK123 / MK277 EXCL bearings)	Check strut body length. OE #s: start with 901... and 903...; plus 2D0413029 & 2D0413029B	V1166	-	-	-	⊕ ⊕ (Top eye 14mm ID / Btm eye 14mm ID)
	Strut body length 345.5mm	V4507	-	-	PK123 / MK277 EXCL bearings)	Check strut body length. OE #s: start with 901... and 903...; plus 2D0413029 & 2D0413029B	V1166	-	-	-	

For Microbus ... see Kombi

Key	
*	See important installation information on inside front cover
!	Excluding self-levelling suspension
"..."	Special order - phone 010 900 1850. 6-12 week waiting period

~	Imported
#	Internal bump stop
⊕	Steering damper

- It is recommended that all new shock absorbers are fitted in pairs
- Do not mix gas and non-gas units on the same axle
- **Bold** part numbers indicate heavy-duty shocks
- Underlined part numbers indicate parts not immediately available
- *Italic* part numbers followed by > indicate parts to be discontinued

Passenger and light commercial

Part number [alphabetical listing]

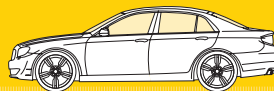

Year	Application	Front					Rear				
		Entry shocks	Premium shocks	Springs	Protection kits/ Mounting kits	Mounting information	Entry shocks	Premium shocks	Springs	Protection kits/ Mounting kits	Mounting information
VOLKSWAGEN continued											
Passat											
81-87	Passat Sedan & S/Wagon (B2)	GT0102	—	—	PK001 / "MK032" (NCL) bearings)		R3726 -	—	—	PK017	
99-05	Passat Sedan (EXCL S/W, Sport Susp & 4WD 4 Motion Syncro) (B5)	26663	376054SP >	—	PK088 / MK190 (EXCL) bearings)		45008	376081SP >	—	"PK101" / "MK187" (EXCL) bearings)	
99-05	Passat Sedan 2.3 V5 & 2.8 4WD 4 Motion Syncro (EXCL Sport Susp) (B5)	26663	376054SP >	—	PK088 / MK190 (EXCL) bearings)		G2246 ! *10	376058SP > ! *10	—	"PK101" / "MK187" (EXCL) bearings)	OE# = 3B5513031D
05-11	Passat Sedan & S/Wagon (NCL) AWD 4 Motion Syncro (EXCL Sport Susp & Elec Susp) (B6)	GT8057 !	—	—	PK163 / MK194 (NCL) bearings)		GT2210 !	—	—	PK137 / MK203 (EXCL) bearings)	
05-11	Passat Sedan, & S/Wagon Sportline Sport Susp (NCL) AWD 4 Motion Syncro (EXCL elec susp) (B6)	GT8056 > GT8057 !	742247SP > !	—	PK163 / MK194 (NCL) bearings)		GT2210 !	—	—	PK137 / MK203 (EXCL) bearings)	
05-11	Passat Sedan, & S/Wagon All Electronic Suspension (B6)	—	C2513S	—	—		—	C1514R & C1517L	—	—	
11-Aug'15	Passat sedan (EXCL) Sport Susp & 4WD 4 Motion Syncro) (B7) (EXCL) elec susp	GT8057	—	—	PK163 / MK194 (NCL) bearings)		GT2210 !	—	—	PK137 / MK203 (EXCL) bearings)	
Sept'15-19	Passat sedan (EXCL) elec susp) (B8)	—	742269SP !	—	PK422		—	376246SP !	1.4 & 2.0 (EXCL) AWD, Diesel & Hybrid) = "SP4248" 1.8 & 2.0D (EXCL) AWD & Hybrid) = "SP4249"	PK424	
Sept'15-19	Passat sedan All Electronic Suspension (B8)	—	C2516S	—	—		—	C1521S	—	—	

For Passat CC ... see CC

Polo

98-Sept'02	Polo Playa Hatch & Classic Sedan (mk 3 6N) (EXCL) sport susp	GT8037	—	SP3177	PK001 / MK067 (NCL) bearings)		GT1016 *8 *9	—	Hatch = SP0709 Sedan = "SP2074"	PK048 / MK133 (EXCL) bearings)	
Oct'02-Jan'10	Polo Hatch & Classic Sedan (EXCL) CrossPolo (mk 4 9N3)	GT8023 > GT8123	—	SP3387 > SE3387 (EXCL) Gti & Sport susp)	PK012 / MK156 (NCL) bearings)		GT1003 (EXCL) Gti & Sport susp)	G1339 (Gti & Sport susp)	—	PK078 / MK118 (EXCL) bearings)	
Feb'10-Jan'18	Polo Hatch, (EXCL) Vivo, Sedan & Cross (mk 5 model, 6R, 6C)	GT8123 (EXCL) Gti & Sport susp)	742044SP (Gti & Sport susp)	1.2TSi = SP3921	PK076 / MK077 (NCL) bearings)	(additional bottom brackets)	GT1003 (EXCL) Gti & Sport susp)	G1339 (Gti & Sport susp)	1.2TSi & 1.4Tdi = SP3922	PK078 / MK118 (EXCL) bearings)	
Feb'10-19	Polo Sedan, (EXCL) Vivo, Gti, hatch (mk 5 model, 6V2)	GT8123	—	—	PK076 / MK077 (NCL) bearings)		GT1231 or G1239 (check lengths)	—	—	PK078 / MK118 (EXCL) bearings)	GT1231 OE# = 6R0512011BT body length 396mm / G1239 OE# = 6RF512011A, 6RU513025A body length 421mm
Feb'18-on (Gti from June '18)	Polo Hatch, (EXCL) Vivo, Sedan & Cross (mk 6, model AW)	GT8625	—	—	PK422 / MK411 (NCL) bearings)		GT1376	—	—	MK436 (EXCL) bearings)	
20-on	Polo 1.6 Sedan (mk 5 facelift)	GT8625	—	—	PK422 / MK411 (NCL) bearings)		G1239	—	—	PK078 / MK118 (EXCL) bearings)	G1239 OE# = 6RF512011A, 6RU513025A body length 421mm

Polo Vivo

Feb'10-Feb'18	Polo VIVO (mk 4 9N3) (EXCL) Maxx	GT8123 (EXCL) GT & Sport susp)	742044SP (GT & Sport susp)	—	PK076 / MK077 (NCL) bearings)		GT1003 (EXCL) GT & Sport susp)	G1339 (GT & Sport susp)	SP3388 > (EXCL) GT)	PK078 / MK118 (EXCL) bearings)	
March 18-on	Polo VIVO (mk 5 model, 6R, 6C) (EXCL) Maxx	GT8123 (EXCL) GT & Sport susp)	742044SP (GT & Sport susp)	1.2TSi = SP3921	PK076 / MK077 (NCL) bearings)		GT1003 (EXCL) GT & Sport susp)	G1339 (GT & Sport susp)	1.2TSi & 1.4Tdi = SP3922	PK078 / MK118 (EXCL) bearings)	

Key

*	See important installation information on inside front cover
!	Excluding self-leveling suspension
"..."	Special order - phone 010 900 1850. 6-12 week waiting period

~	Imported
#	Internal bump stop
⊕	Steering damper

- It is recommended that all new shock absorbers are fitted in pairs
- Do not mix gas and non-gas units on the same axle
- **Bold** part numbers indicate heavy-duty shocks
- Underlined part numbers indicate parts not immediately available
- *Italic* part numbers followed by > indicate parts to be discontinued

Passenger and light commercial

Part number [alphabetical listing]

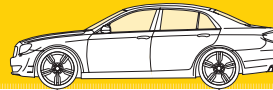

Year	Application	Front					Rear				
		Entry shocks	Premium shocks	Springs	Protection kits/ Mounting kits	Mounting information	Entry shocks	Premium shocks	Springs	Protection kits/ Mounting kits	Mounting information
VOLKSWAGEN <i>continued</i>											
Polo Cross & Vivo Maxx											
10/02-1/10	CrossPolo & Vivo Maxx Sport Susp (mk 4 9N3)	GT8123	—	—	PK076 / MK077 bearings)		GT1231 OR G1239 (check lengths)	—	—	PK078 / MK118 bearings)	⊥ ⊕ GT1231 OE# = 6R0512011BT body length 396mm / G1239 OE# = 6RF512011A, 6RU513025A body length 421mm
11-18	CrossPolo & Vivo Maxx Sport Susp (mk 5 6R)	GT8123	—	—	PK076 / MK077 bearings)		GT1231 OR G1239 (check lengths)	—	—	PK078 / MK118 bearings)	⊥ ⊕ GT1231 OE# = 6R0512011BT body length 396mm / G1239 OE# = 6RF512011A body length 421mm
Scirocco											
09-17	Scirocco elec, R or sport susp (137)	<i>GT8056 > GT8057</i>	<i>742247SP ></i>	—	PK163 / MK194 bearings)		GT2210	<i>376099SP ></i>	—	PK078 / MK203 bearings)	⊥ ⊕
Sharan											
98-07	Sharan MPV (7M8, 7M9, 7M6)	G16694	—	—	"PK060" / MK067 bearings)		23957	—	—	—	⊕ ⊕
Taigo											
22-on	Taigo 1.0 crossover SUV										
T-Cross											
19-on	T-Cross SUV (C11)	GT8625	—	—	PK422 / MK411 bearings)		GT1376	—	—	MK436 bearings)	⊥ ⊕
T-Roc											
20-on	T-Roc SUV electronic susp (A11)	—	742117SP	"SP4350"	PK422 / MK411 bearings)	 (55mm strut leg)	—	376277SP !	"SP4351"	PK424 / MK517 bearings)	⊥ ⊕
Tiguan											
08-Sept 16	Tiguan 4 Motion AWD & FWD Blue Motion elec susp gen 1 (5N)	<i>GT8056 > GT8057 !</i>	<i>742247SP > !</i>	—	PK163 / MK194 bearings)		G1364 !	<i>376063SP > !</i>	—	PK137 / MK203 bearings)	⊥ ⊕
08-Sept 16	Tiguan Elec Susp gen 1 (5N)	—	<u>C2513S</u>	—	—		—	"C1515R" & "C1516L"	—	—	⊥ ⊕
Oct 16-23	Tiguan 4 Motion AWD & FWD 1.4TSi, 2.0 Tdi, 2.0TSi gen 2 Allspace 7 seater (AD, BW) electronic suspension	—	742117SP	—	PK422 / MK411 bearings)	 (55mm strut leg)	—	<u>376246SP !</u>	—	PK424	⊥ ⊕
Oct 16-23	Tiguan 4 Motion AWD & FWD 1.4TSi, 2.0 Tdi, 2.0TSi Electronic Suspension gen 2 Allspace 7 seater (AD, BW)	—	<u>C2516S</u>	—	—		—	<u>C1521S</u>	—	—	⊥ ⊕
24-on	Tiguan 4 Motion AWD & FWD gen 3 Allspace 7 seater (...) electronic suspension	—	—	—	—	—	—	—	—	—	—
Touareg											
04-10	Touareg 4x4 Elec, air or sport susp (7L)	—	<i>D0303 > D0303R / D0304L</i>	—	PK329 / MK341 bearings)	⊥ ⊗	—	<i>D8072 > D8072S !</i>	—	—	⊥ ⊕ S/pan unit
11-18	Touareg 4x4 Elec or sport susp (7P)	—	<i>D0312 > D0312R / D0313L</i>	—	—		—	<i>D0314 > D0314S !</i>	—	—	⊥ ⊕ S/pan unit
19-on	Touareg 4x4 Elec or sport susp (CR)	—	—	—	—	—	—	!	—	—	—

Key

* See important installation information on inside front cover	~ Imported
! Excluding self-levelling suspension	# Internal bump stop
"..." Special order - phone 010 900 1850. 6-12 week waiting period	⊕ Steering damper

- It is recommended that all new shock absorbers are fitted in pairs
- Do not mix gas and non-gas units on the same axle
- **Bold** part numbers indicate heavy-duty shocks
- Underlined part numbers indicate parts not immediately available
- *Italic* part numbers followed by > indicate parts to be discontinued

Passenger and light commercial

Part number [alphabetical listing]

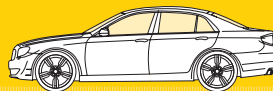

Year	Application	Front					Rear				
		Entry shocks	Premium shocks	Springs	Protection kits/ Mounting kits	Mounting information	Entry shocks	Premium shocks	Springs	Protection kits/ Mounting kits	Mounting information
VOLKSWAGEN continued											
Touran											
04-16	Touran MPV Elec & heavy duty Susp (1T gen 1)	<i>GT8056</i> > <i>GT8057</i> !	<i>742247SP</i> > !	–	PK163 / MK194 () bearings)		GT2210 !	–	–	"PK145" (oval) OR "PK331" (round) / MK386 (oval) OR MK203 (round) both bearings	⊥ ⊕
04-16	Touran MPV Electronic Susp (1T gen 1)		<i>C2513S</i>	–		 Elec susp		<i>C1514R</i> & <i>C1517L</i>	–		⊥ ⊕ Elec susp
For Transporter ... see Kombi											
Up											
13-23	Up hatch 1.0 Cross	G7112	–	–	PK357 / MK077 () bearings)		G2165	–	–	PK371	⊥ ○
VOLVO											
144 / 164											
72-74	144 & 164 (Will also fit '66-71 models)	–	–	–	–	⊥ ⊕	"R324Z"	–	–	–	⊕ ○
850											
94-96	850 Sedan & S/Wagon (Lowered and Nivomat self leveling suspension)	"11669"	–	–	PK004 / "MK141" OR "MK243"		"G21632" *5	–	–	"MK134"	⊗ ⊕ (OE springs x 2 must also be used)
960											
94-96	960 Sedan & S/Wagon (Leaf spring susp) coil rear suspension	"G8322"	–	–	"PK011" / "MK085"		–	–	–	–	○ ○
C30											
07-13	C30 Hatch	<i>G8811</i> R <i>G8812</i> !	<i>742061SP</i> R > <i>742062SP</i> L >	1.8 & 2.0 = "SP3564"	PK156 / MK282 () bearings)	 OE# = 30683611, 30714385, 3M5118045EBH	G1234	–	1.6, 1.8, 2.0, 2.4 = "SP3894"	PK184 / MK394 () bearings)	⊥ ○
C40 Recharge											
22-on	C40 Recharge Crossover SUV		–	–				–	–		
C70											
97-05	C70 Coupe & Cabrio	"11669"	–	–	PK004 / "MK243"		"G21632" *5	–	–	–	⊗ ⊕ (OE springs x 2 must also be used)
06-14	C70 Cabriolet	<i>G8811</i> R <i>G8812</i> !	<i>742061SP</i> R > <i>742062SP</i> L >	–	PK156 / MK282 () bearings)	 OE# = 30683611, 30714385, 3M5118045EBH	–	–	–	PK184 / "MK376"	⊥ ⊕
EX30											
23-on	EX30 Electric Crossover SUV										
EX90											
23-on	EX90 Electric SUV										
S40 (Incl older V40 & V50)											
95-May'99	S40 Sedan & V40 S/W (Sport & T4)	<i>16688R</i> / <i>16689L</i> *2	–	SP0300	PK044 / MK140 () bearings)	 OE# = 65560 or 65556	23907 ! *2 *6	–	Sedan = SP0718 - S/W = SP0566	PK081 / MK244 () bearings)	⊥ ⊕ Spring Seat unit
95-May'99	S40 Sedan & V40 S/W T4 and Sportline	<i>G16690</i> R <i>G16691</i> ! *2	–	–	PK044 / MK140 () bearings)	 OE# = 65555, 65578 & 65579	<i>23829</i> > / 23907 ! *2 *6	–	–	PK081 / MK244 () bearings)	⊥ ⊕ Spring Seat unit

Key

*	See important installation information on inside front cover
!	Excluding self-leveling suspension
...	Special order – phone 010 900 1850. 6-12 week waiting period

~	Imported
#	Internal bump stop
⊕	Steering damper

- It is recommended that all new shock absorbers are fitted in pairs
- Do not mix gas and non-gas units on the same axle
- **Bold** part numbers indicate heavy-duty shocks
- Underlined part numbers indicate parts not immediately available
- *Italic* part numbers followed by > indicate parts to be discontinued

Passenger and light commercial

Part number [alphabetical listing]

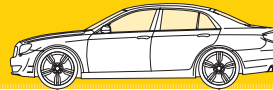

Year	Application	Front					Rear				
		Entry shocks	Premium shocks	Springs	Protection kits/ Mounting kits	Mounting information	Entry shocks	Premium shocks	Springs	Protection kits/ Mounting kits	Mounting information
VOLVO continued											
S40 (Incl older V40 & V50) continued											
June'99-April'00	S40 Sedan & V40 S/W EXCL Sport & T4	G16783 R G16784 L	—	SP3490 > SE3490	PK044 / MK140 INCL bearings) / MK389 (bearing only)		23907 ! *2 *6	—	Sedan = SP3488 S/W = SP3489	PK081 / MK244 EXCL bearings)	
June'99-April'00	S40 Sedan & V40 S/W T4	G16785 R G16786 L	—	—	PK044 / MK140 INCL bearings) / MK389 (bearing only)		23829 > / 23907 ! *2 *6	—	—	PK081 / MK244 EXCL bearings)	
April'00-May'04	S40 Sedan & V40 S/W EXCL Sport & T4	16796 R 16797 L	—	SP3490 > SE3490	PK086 / MK140 INCL bearings)	 OE# = 30884195, 30884196, 30616858, 30616683, 67139, 65596, 65597	23932 *2 *6	—	Sedan = SP3488 S/W = SP3489	PK081	 / OE# = 16402
April'00-Late'04	S40 Sedan & V40 S/W T4	16798 R 16799 L	—	—	PK086 / MK140 INCL bearings)	 OE# = 65583 or 30884213	23932 *2 *6	—	—	PK081	
June'04-Oct'12	S40 Sedan & V50 S/W INCL T5 (Gen 2)	G8811 R G8812 L	742061SP R > 742062SP L >	—	PK156 / MK282 INCL bearings)	 OE# = 30683611, 30714385, 3M5118045EBH, 30683608, 30683609	G1234	—	—	PK184 / MK394 EXCL bearings)	
S60											
00-10	S60 Sedan gen 1 EXCL elec susp, Four-C, R 2.5 20v, AWD, Lowered & Nivomat Levelling Suspensions)	G16826 !	742054SP > !	—	PK105 / MK159 INCL bearings)		G55023 !	—	—	MK195 EXCL bearings)	
00-10	S60 Sedan, Gen 1 All Electronic susp and S60 R AWD Four-C	—	"C2501S" = R2.5 20v AWD OR "C2502S" = Std OR 2.4 & 2.5 EXCL R2.5	—	—	 Elec susp, Specify model	—	"C1501S" = R2.5 20v AWD OR "C1502S" = Std OR "C1503S" = 2.4 & 2.5 EXCL R2.5	—	—	 Elec susp, Specify model
10-18	S60 Sedan, gen 2 EXCL elec susp	G8421 R G8422 L !	—	T4 & T5 = "SP4068" / D4 = "SP4114"	PK292 / MK323 INCL bearings)		G2224 ! EXCL AWD)	—	"SP4115"	PK398 / MK393 EXCL bearings)	 no dust cover EXCL AWD
10-18	S60 Sedan, gen 2 Electronic susp	—	C2510R / C2511L	—	—	 Elec susp	—	C1512S	—	—	 Elec susp
19-on	S60 Sedan, gen 3 EXCL elec susp	!	!	—	—	—	!	!	—	—	—
19-on	S60 Sedan, gen 3 Electronic susp	—	—	—	—	—	—	—	—	—	—
S70											
97-'00	S70 Sedan (EXCL lowered & Nivomat leveling suspension)	"11669"	—	—	PK004 / "MK141" INCL bearings)		"G21632" *6 *5 !	—	—	"MK134"	 (OE springs x 2 must be used)
S80											
98-July'06	S80 Sedan gen 1 EXCL elec susp Four-C, Lowered & Nivomat Leveling Suspensions).	G16826 !	742054SP > !	—	PK105 / MK159 INCL bearings) (only certain chassis #s)	 Check chassis # for correct model year	G55023 !	—	—	MK195 EXCL bearings)	 Check chassis # for correct model year
98-July'06	S80 Sedan gen 1 Elec Susp Four-C.	—	"C2502S"	—	—	 Electronic susp / Check chassis # for correct model year	—	"C1502S"	—	—	 Electronic susp / Check chassis # for correct model year

Key	
*	See important installation information on inside front cover
!	Excluding self-levelling suspension
"..."	Special order - phone 010 900 1850, 6-12 week waiting period

~	Imported
#	Internal bump stop
	Steering damper

- It is recommended that all new shock absorbers are fitted in pairs
- Do not mix gas and non-gas units on the same axle
- **Bold** part numbers indicate heavy-duty shocks
- Underlined part numbers indicate parts not immediately available
- *Italic* part numbers followed by > indicate parts to be discontinued

Passenger and light commercial

Part number [alphabetical listing]

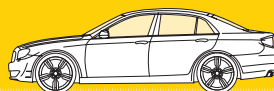

Year	Application	Front					Rear				
		Entry shocks	Premium shocks	Springs	Protection kits/ Mounting kits	Mounting information	Entry shocks	Premium shocks	Springs	Protection kits/ Mounting kits	Mounting information
VOLVO continued											
S80 continued											
Aug'06-'14	S80 Sedan gen 2 (Excl elec susp, T6, Four-C, Lowered, sport & Nivomat Levelling Suspensions)	G8198 R G8199 I	742106SP R > 742107SP L >	—	PK292 / MK323		G2224 !	—	—	—	⊥ ⊕
Aug'06-'14	S80 Sedan T6 AWD gen 2 All (Excl elec susp, Lowered & Nivomat Levelling Suspensions)	G8198 R G8199 I	742106SP R > 742107SP L >	—	PK292 / MK323		—	!	—	—	⊥ ⊕
Aug'06-'14	S80 Sedan gen 2 Electronic Susp, Four-C	—	C2510R & C2511L	—	—	 Elec susp	—	C1512S	—	—	⊥ ⊕ Elec susp
S90											
97-98	S90 Sedan gen 1 (Excl elec or self level susp)	"G8322"	—	—	"PK057" / "MK085"		"G1258" !	—	—	—	⊕ ⊕
17-23	S90 Sedan gen 2 (Excl elec or self level susp)	G7934 !	—	—	—		"G2552" !	—	—	—	⊥ ⊕
For older V40 & all V50 ... see S40											
V40											
12-19	V40 Hatch (Incl T series)	G8419 R G8420 I	—	Std & T5 = "SP4313" OR "SP4314" T3 & T4 = "SP4312"	MK282 (Incl bearings)		G1219	—	Std, T3, T4 & T5 = "SP4315" D2 = "SP4316"	—	⊥ ⊕
V40 Cross Country											
12-19	V40 Cross Country (Incl T5)	G8425 R G8426 I (4x2 & AWD)	—	—	MK282 (Incl bearings)		G1219 (4x2 only)	—	—	—	⊥ ⊕
For older V40 & V50 station wagon ... see S40 sedan											
For newer V40 hatch ... see V40 above											
V60 and V60 Cross Country											
11-18	V60 Station Wagon (Incl Cross Country) (Excl elec susp)	G8421 R G8422 I !	!	—	PK292 / MK323 (Incl bearings)		G2224 ! (Excl AWD)	!	—	—	⊥ ⊕ No dust cover (Excl AWD)
11-18	V60 Station Wagon (Incl Cross Country) Electronic susp	—	C2510R / C2511L	—	—	 Elec susp	—	C1512S	—	—	⊥ ⊕ Elec susp
V70											
97-Feb'00	V70 Station Wagon Gen1 (Excl Elec Four-C & Nivomat rears)	"11669" !	—	—	PK004 / "MK141" (Incl bearings)		"G21632" ! *6	—	"SP0324"	"MK134" (Excl bearings)	⊥ ⊕
00-07	V70 Station Wagon Gen 2 (Excl elec susp, Four-C, R 2.5 20V, XC AWD, Lowered & Nivomat Levelling Suspensions)	G16826	742054SP >	—	PK105 / MK159 (Incl bearings)		G55023 !	—	—	MK195 (Excl bearings)	⊥ ⊕
Feb'00-07	V70 Station Wagon Gen 2 All (Incl Four-C AWD, V70 R & Elec susp (Excl XC 4WD))	—	"C2501S" = R2.5 T AWD OR "C2502S" = Std 4x2 OR AWD	—	—	 Elec susp Specify model	—	"C1501S" = R2.5 T AWD OR "C1502S" = Std 4x2	—	—	⊥ ⊕ Elec susp Specify model
07-10	V70 Station Wagon Gen 3 (Excl D5, T6, Four-C AWD, V70 R, Elec susp, XC 4WD)	G8198 R G8199 I !	742106SP R > 742107SP L >	—	PK292 / MK323 (Incl bearings)		G2224 ! *6 (Excl - 3.0 T6, 2.4 D5 & AWD)	—	—	MK393 (Excl bearings)	⊥ ⊕
07-10	V70 Station Wagon Gen 3 All (Incl Four-C AWD & Elec susp (Excl XC 4WD))	—	C2510R / C2511L	—	—	 Elec susp	—	"C1513S"	—	—	⊥ ⊕ Elec susp
V90											
97-98	V90 Station Wagon (Excl XC90 4WD Cross Country)	"G8322"	—	—	"MK085"		—	—	—	—	⊕ ⊕
17-23	V90 Station Wagon (Excl XC90, Cross Country)	G7934 !	—	—	—		G2551 ! (AWD only)	—	—	—	⊥ ⊕
17-23	V90 Cross Country Station Wagon (Excl XC90)	G7934 !	—	—	—		G2551 !	—	—	—	⊥ ⊕

Key

*	See important installation information on inside front cover
!	Excluding self-levelling suspension
"..."	Special order – phone 010 900 1850. 6-12 week waiting period

~	Imported
#	Internal bump stop
⊕	Steering damper

- It is recommended that all new shock absorbers are fitted in pairs
- Do not mix gas and non-gas units on the same axle
- **Bold** part numbers indicate heavy-duty shocks
- Underlined part numbers indicate parts not immediately available
- *Italic* part numbers followed by > indicate parts to be discontinued

Passenger and light commercial

Part number [alphabetical listing]

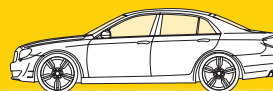

Year	Application	Front					Rear				
		Entry shocks	Premium shocks	Springs	Protection kits/ Mounting kits	Mounting information	Entry shocks	Premium shocks	Springs	Protection kits/ Mounting kits	Mounting information
VOLVO <i>continued</i>											
XC40 AWD											
18-22	XC40 AWD Cross Country SUV gen 1 EXCL Recharge elec & self leveling susp		–	–			!	!	–		
22-on	XC40 AWD Recharge electric		–	–			!	!	–		
XC60 AWD											
09-Sept 18	XC60 AWD Cross Country SUV gen 1 EXCL elec & self leveling susp	–	742240SP R 742241SP L	–	PK370 / MK323 INCL bearings)		–	376157SP ! *6	2,4 = "SP4240"	MK393 EXCL bearings)	⊥ ⊕
Oct 18-23	XC60 AWD Cross Country SUV gen 2 EXCL Recharge elec & self leveling susp	–	G7933	–			G2551 !	!			⊥ ⊕
23-on	XC60 AWD Recharge electric		–	–			!	!	–		
XC70 AWD											
00-July 07	XC70 SUV AWD gen 2 EXCL Four-C elec & self level suspension	G16826	742054SP >	–	PK105 / MK159 INCL bearings)		G55023	!	–	MK195 EXCL bearings)	⊥ ⊕
00-July 07	XC70 SUV AWD 2.5 Cross Country Station Wagon Four-C gen 2 Elec susp		"C2503S"	–	–	 Elec susp	–	"C1503S"	–	–	⊥ ⊕ Elec susp
Aug 07-15	XC70 SUV AWD 3.0 T6, 3.2, 2.4 D5 gen 3 EXCL elec susp	G8198 R G8199 L	742106SP R > 742107SP L >	–	PK105 / MK323 INCL bearings)		G2224 !	–	–	MK393 EXCL bearings)	⊥ ⊕
XC90 AWD											
02-July 15	XC90 AWD 2.4D, 3.2, 4.4 V8 Cross Country Station Wagon gen 1 EXCL Elec or self lev susp)	–	742073SP !	–	PK414 / MK159 INCL bearings)		–	376098SP !	–	–	⊥ ⊕
Aug 15-on	XC90 AWD 2.5 T5 & 2.5 D5 Cross Country Station Wagon gen 2 EXCL Elec or self lev susp)	–	G7933	–			G2551 !	!			⊥ ⊕
WILLYS											
CJ											
45-62	CJ2, CJ3 Jeep	M8039	–	–	–	○ ○	M8039	–	–	–	○ ○
66-79	CJ5, CJ6 & CJ7 Jeep	M8039	–	–	–	○ ○	M8038 / GT2008	–	–	–	○ ○

For other Jeep products ... see Chrysler

Key

*	See important installation information on inside front cover
!	Excluding self-levelling suspension
"..."	Special order – phone 010 900 1850, 6-12 week waiting period

~	Imported
#	Internal bump stop
⊕	Steering damper

- It is recommended that all new shock absorbers are fitted in pairs
- Do not mix gas and non-gas units on the same axle
- **Bold** part numbers indicate heavy-duty shocks
- Underlined part numbers indicate parts not immediately available
- *Italic* part numbers followed by > indicate parts to be discontinued



WHAT ARE SHOCKS AND STRUTS?

SHOCKS AND STRUTS HELP KEEP YOUR VEHICLE'S TIRES IN CONTACT WITH THE ROAD

- ✓ Shocks and struts not only improve ride comfort but are necessary for safe handling.
- ✓ Shocks and struts maintain vertical loads placed upon the tires. This helps ensure consistent, firm tire-to-road contact.
- ✓ By providing resistance to vehicle bounce, roll and sway - as well as brake dive and acceleration squat - shocks and struts help to maintain a balanced ride.



Shock absorbers are individual components of the suspension system



Struts are a major structural component of the vehicle chassis and suspension

WHAT DO SHOCKS AND STRUTS DO?

SHOCKS AND STRUTS PLAY A CRUCIAL ROLE IN A VEHICLE'S STEERING, STOPPING AND STABILITY

THE VITAL FUNCTIONS THAT RIDE CONTROL PRODUCTS PERFORM:

- Control excessive body and tire movement
- Reduce vehicle bounce, roll and sway plus brake dive and acceleration squat
- Help to maintain consistent handling and braking
- Help maintain wheel alignment
- Help to reduce the potential of premature wear on tires and other suspension components

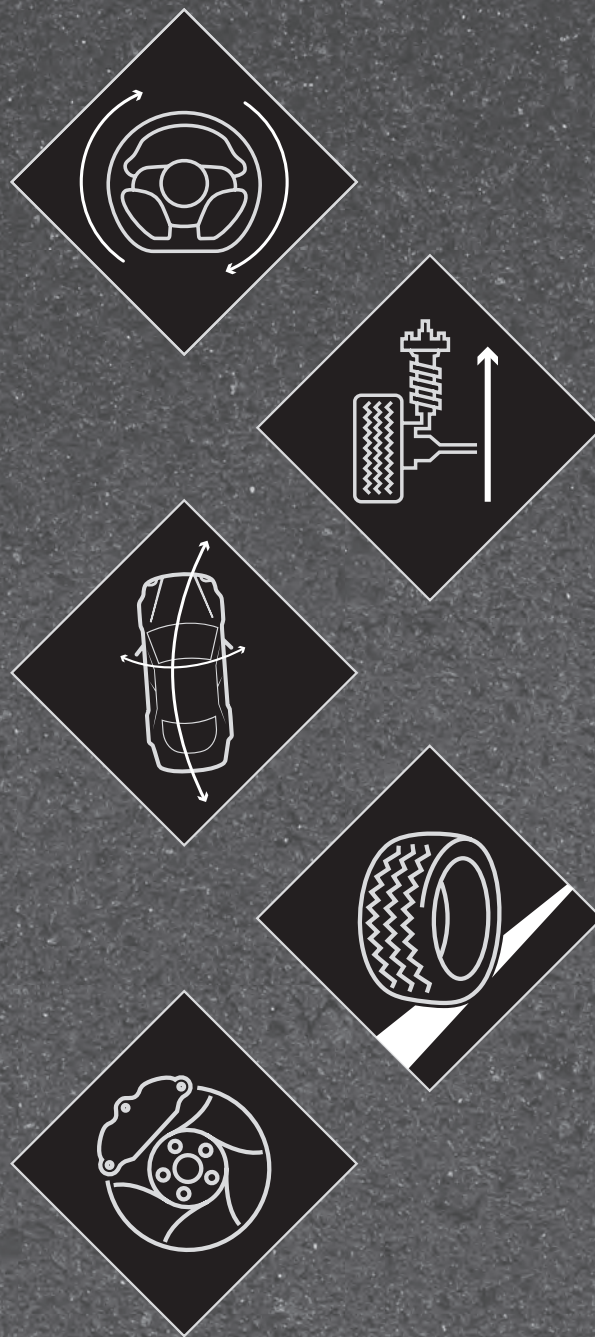

FOR YOUR SAFETY
CHANGE YOUR SHOCKS!

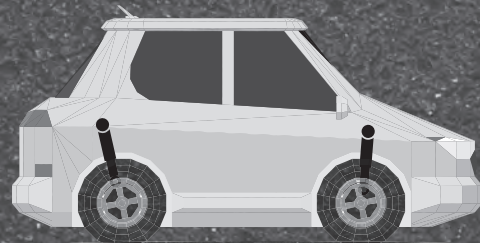

FIND YOUR NEAREST DEALER
on www.MONROE.com

WHY TO REPLACE

It can be easy to overlook the gradual degradation of steering, stopping and stability caused over time by worn ride control components.

DISCUSS THE VEHICLE'S REPAIR HISTORY, THE WAY THE VEHICLE HANDLES AND ITS INTENDED USE.

Have the shocks or struts been in service for 50,000 miles / 80,000 kilometres or more?

Does the vehicle require repeated replacement of front brakes, suspension components or tires?

Has the ride quality changed over time?

Is the vehicle used in any of the following ways:

- Towing
- Off-road use
- Consistently loaded
- Agricultural use
- Commercial use
- Upgraded with performance enhancements
- Consistently driven on unpaved roads

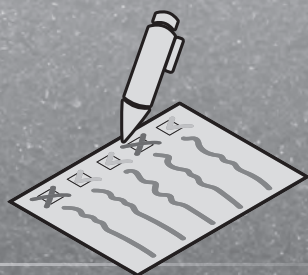

WHAT DOES YOUR ODOMETER READ?

50,000 Mile / 80,000 km Replacement recommendation* helps improve vehicle handling characteristics and comfort.

A fresh set of shocks can enhance more than just your ride. They help improve braking and handling under certain driving conditions and they make vehicles safer and easier to control. This helps make the road safer for everyone.

Just one degraded shock absorber on your vehicle can increase stopping distances under certain driving conditions.

*At 60 mph / 100 kph. Tests performed on dry, bumpy surface. Actual mileage may vary, depending upon driver ability, vehicle type, and type of driving and road conditions

SYMPTOMS OF PHYSICAL WEAR WHICH MAY INDICATE NEW SHOCKS AND STRUTS ARE REQUIRED:

- ✓ Are there any signs of physical damage which could compromise the ride control unit's ability to function as intended?
- ✓ Is the rod bent, rusted, loose or scratched?
- ✓ Does the air shock have a torn or leaking air boot?
- ✓ Is fluid leaking down the side or on the bottom of the unit?
- ✓ Has corrosion compromised the integrity of any components which make up the shock or strut?
- ✓ Are non-replaceable bushings damaged or missing?
- ✓ Do the vehicle's tires display cupped, uneven or accelerated tire wear?
- ✓ Is the electronic unit producing a diagnostic code indicating failure?

NOTE: This may require additional electronic circuit diagnostics

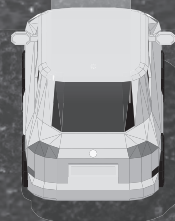

Truck, bus and trailer

Part number [alphabetical listing]

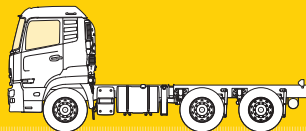

		Front				Rear			
Year	Application	Magnum	Cab damper	Original equipment cross-reference	Mounting information	Magnum	Cab damper	Original equipment cross-reference	Mounting information
BEDFORD									
65-75	J2, J3, J4, J4L, J5 & J6	AU160132		-	⊥ T		-	-	
BENSON									
All	Benson Trailer with Neway suspension	-	-	-		65418 >	-	OE# = 90044089	⊕ ⊖
BROSHUIS									
Check OE#s	Broshuis Trailers	-	-	-		F5004	-	OE#s: 0237021900 / 0237025200	⊕ ⊖
BPW / BERISCHE ACHSEN									
Check OE#s	BPW / Bergische Achsen Trailers	-	-	-		F5004 *13 or "F5007" *13	-	F5004 = OE#s: 0237021900 / 0237025200 / 0237228300 F5007 = OE#s: 02 3702 2000 02 3702 2200	⊕ ⊖ F5004 (ID= 24mm, closed 326mm, open 496mm), F5007 (ID = 24mm, closed 426, open 694mm)
CARDI									
Check OE#s	Cardi Trailer	-	-	-		F5004 *13 or "F5007" *13	-	F5004 OE#s = 00501300 / 00501310 F5007 OE# = 00500600 00501000 500600	⊕ ⊖ F5004 (ID= 24mm, closed 326mm, open 496mm), F5007 (ID = 24mm, closed 426, open 694mm)
DAF									
Various	DAF FA 1900	"T5046"	-	OE# = 1283732 or 22773	⊕ ⊖	-	-		
Various	DAF 65 CF (front leaf, rear air susp)	T5053	-	OE# = 1283724 or 1283725 or 1283852 or 279245 or 378220 or 86756	⊥ ⊖	"T5045"	-	T5045 OE# = 1282623 or 1328748 or 360585 or 740021 or 755262	⊕ ⊖
		T5227		T5227 = OE#s: 1382703 1382704 1427903 1618606 1696291 1696292	⊥ T	"T5180"		T5180 = OE#s: 1369711 1443695 1450885 1606742	⊕ ⊖
Various	DAF 65 (front leaf, rear air susp)	T5053	-	OE# = 1283724 or 1283725 or 1283852 or 279245 or 378220 or 86756	⊥ ⊖	"T5180"		T5180 = OE#s: 1369711 1443695 1450885 1606742	⊕ ⊖
		T5227		T5227 = OE#s: 1382703 1382704 1427903 1618606 1696291 1696292	⊥ T				
Various	DAF 75	T5053	-	OE# = 1283724 or 1283725 or 1283852 or 279245 or 378220 or 86756	⊥ ⊖ (leaf spring susp)	"T5046"	-	T5046 OE# = 1283732 or 22773	⊕ ⊖ (Air susp)
		T5227		T5227 = OE#s: 1382703 1382704 1427903 1618606 1696291 1696292	⊥ T (leaf spring susp)	"T5045"	-	T5045 OE# = 1282623 or 1328748 or 360585 or 740021 or 755262	⊕ ⊖ (Air susp)
						"T5180"		T5180 = OE#s: 1369711 1443695 1450885 1606742	⊕ ⊖ (Air susp)
						"T5182"		T5182 = OE#s 1443696 1606743 1649947	⊕ ⊖ (Air susp)

Key

*	See important installation information on inside front cover
!	Excluding self-levelling suspension
...	Special order - phone 010 900 1850. 6-12 week waiting period

~	Imported
#	Internal bump stop
⊕	Steering damper

- It is recommended that all new shock absorbers are fitted in pairs
- Do not mix gas and non-gas units on the same axle
- **Bold** part numbers indicate heavy-duty shocks
- Underlined part numbers indicate parts not immediately available
- *Italic* part numbers followed by > indicate parts to be discontinued
- *13 Check the OE part number on the old shock for the correct application

Truck, bus and trailer

Part number [alphabetical listing]

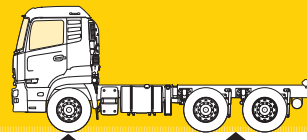

Year	Application	Front				Rear			
		Magnum	Cab damper	Original equipment cross-reference	Mounting information	Magnum	Cab damper	Original equipment cross-reference	Mounting information
DAF continued									
								T1193 = OE# 1286348	⊥ ⊕
								T5070 OE # = 1283729 or 379131	⊥ T (Leaf spring susp)
								T5357 OE # = 1440457 or 1610800	⊕ ⊕ (Leaf spring susp)
								T5181 = OE#'s: 1283735 1618608	⊥ T (Leaf spring susp)
	DAF CF75	T5052 OR T5053		T5052 = OE#'s: 1205672 1283723 1283726 1327883 296305 92968 T5053 OE# = 1283724 1283725 1283852 279245 378220 86756	⊥ ⊕				
All	DAF 85.340, 85.330, 85.430	T5227 OR T5053		T5227 = OE#'s: 1382703 1382704 1427903 1618606 1696291 1696292 T5053 OE# = 1283724 1283725 1283852 279245 378220 86756	T5227 = ⊥ T T5053 = ⊥ ⊕			T5181 = OE#'s: 1283735 1618608	T5181 = ⊥ T
								T5045 OE# = 1282623 or 1328748 or 360585 or 740021 or 755262	⊕ ⊕ (Air susp)
								T5357 OE # = 1440457 or 1610800	⊕ ⊕ (Leaf spring susp)
								T5180 = OE#'s: 1369711 1443695 1450885 1606742 T5182 = OE#'s 1443696 1606743 1649947	T5180 & T5182 = ⊕ ⊕
All	DAF FTS85 (CF85 series)	T5227 OR T5053		T5227 = OE#'s: 1382703 1382704 1427903 1618606 1696291 1696292 T5053 OE# = 1283724 1283725 1283852 279245 378220 86756	T5227 = ⊥ T T5053 = ⊥ ⊕			T5045 OE# = 1282623 or 1328748 or 360585 or 740021 or 755262	⊕ ⊕ (Air susp)
		"T5288"		T5288 = OE # 1307056	⊥ T (Air susp)			T5181 = OE#'s: 1283735 1618608	T5181 = ⊥ T
								T5180 = OE#'s: 1369711 1443695 1450885 1606742 T5182 = OE#'s 1443696 1606743 1649947	T5180 & T5182 = ⊕ ⊕
	DAF CF85	T5052		T5052 = OE#'s: 1205672 1283723 1283726 1327883 296305 92968	⊥ ⊕ (w/leaf)				
	DAF CF65, CF75, CF85 CAB DAMPER		CB0187	OE#'s = 1260941 1265271	⊕ T (w/spring)				
	DAF CF65, CF75, CF85 CAB DAMPER		CB0186	OE#'s = 375221 762784	⊕ T (w/spring)				

Key	
*	See important installation information on inside front cover
!	Excluding self-levelling suspension
...	Special order - phone 010 900 1850. 6-12 week waiting period

~	Imported
#	Internal bump stop
⊕	Steering damper

- It is recommended that all new shock absorbers are fitted in pairs
- Do not mix gas and non-gas units on the same axle
- **Bold** part numbers indicate heavy-duty shocks
- Underlined part numbers indicate parts not immediately available
- *Italic* part numbers followed by > indicate parts to be discontinued
- *13 Check the OE part number on the old shock for the correct application

Truck, bus and trailer

Part number [alphabetical listing]

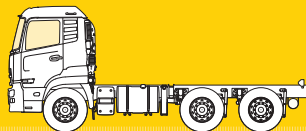

Year	Application	Front				Rear			
		Magnum	Cab damper	Original equipment cross-reference	Mounting information	Magnum	Cab damper	Original equipment cross-reference	Mounting information
DAF continued									
All	DAF FA & FT 95	T5052		T5052 = OE#s: 1205672 1283723 1283726 1327883 296305 92968	T5052 = ⊥ ⊕	"T5169"	—	OE# = 1449271	⊙ ⊙ Midlift axle
		T5227 OR T5053		T5227 = OE#s: 1382703 1382704 1427903 1618606 1696291 1696292 T5053 OE# = 1283724 1283725 1283852 279245 378220 86756	T5227 = ⊥ ⊥ T5053 = ⊥ ⊕	"T5045"	—	T5045 OE# = 1282623 OR 1328748 OR 360585 OR 740021 OR 755262	⊕ ⊕ (Air susp)
		"T1193"	—	T1193 = OE# 1286348	⊥ ⊕	"T5046"	—	OE# = 1283732 OR 22773	⊕ ⊕
		T5183 (7.5 ton)		T5183 = OE#s 1398694 1696290	⊥ ⊥ Leaf spring susp	"T5181"		T5181 = OE#s: 1283735 1618608	T5181 = ⊥ ⊥
						"T5070"		T5070 OE # = 1283729 OR 379131	⊥ ⊥ (Leaf spring susp)
						"T5255"		T5255 = OE # 1282624	⊕ ⊕
						"T5180" OR "T5182"		T5180 = OE#s: 1369711 1443695 1450885 1606742 T5182 = OE#s 1443696 1606743 1649947	T5180 & T5182 = ⊕ ⊕
All	DAF 95	T5052	CB0186	T5052 = OE#s: 1205672 1283723 1283726 1327883 296305 CB0186 OE#s = 375221 762784	T5052 = ⊥ ⊕ CB0186 = ⊕ ⊥				
All	DAF XF95, XF105	T5052 OR T5053 OR T5183	CB0235	T5052 OE#s= 1205672 1283723 1283726 1327883 296305 T5053 OE# = 1283724 1283725 1283852 279245 378220 86756 92968 T5183 OE# = 1398694 1696290 1942781 1944417 CB0235 OE#s= 1337159 1387327 1623464	T5052 & T5053 = ⊥ ⊕ T5183 = ⊥ ⊥ CB0235 = ⊕ ⊥ (spring)		CB0237 OR "CB0042"	CB0237 OE#s = 1319673 1387326 1623465 CB0042 OE#s = 1303516 1436055	CB0237 = ⊕ ⊥ (spring) CB0042 = ⊕ ⊕ (air)

Other DAF models are available as a special order, contact 010 900 1850

ERF									
All	ERF Various trucks	—	—	—		"T5169"	—	Check dimensions	T5169 ⊙ ⊙ (Midlift Axle) Closed = 372mm / Open = 533mm / ID = 20 / bushing = 50mm long
All	ERF ECT 18..., 26...	T1318 OR T1320	CB0199	Check dimensions	T1318 (405/674) ⊥ ⊕ (btm ID 24mm) T1320 (433/714) = ⊕ ⊕ (Top ID 20mm, btm ID 24mm) CB0199 (324/380) = ⊕ ⊕ (ID 12mm) includes spring	T5261 OR T5276 OR T5400 OR T5266 OR T5275		Check dimensions	T5261 (473/768), T5400 (449/723), T5257 (473/768), ⊕ ⊕ (top ID 20mm, btm ID 30mm) (drive axle), T5276 (533/893) (trailing axle), T5266 (530/848) ⊕ ⊕ (ID 20mm)

Key

*	See important installation information on inside front cover
!	Excluding self-levelling suspension
"..."	Special order – phone 010 900 1850. 6-12 week waiting period

~	Imported
#	Internal bump stop
⊕	Steering damper

- It is recommended that all new shock absorbers are fitted in pairs
- Do not mix gas and non-gas units on the same axle
- **Bold** part numbers indicate heavy-duty shocks
- Underlined part numbers indicate parts not immediately available
- *Italic* part numbers followed by > indicate parts to be discontinued
- *13 Check the OE part number on the old shock for the correct application

Truck, bus and trailer

Part number [alphabetical listing]

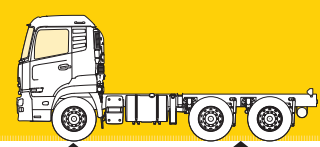

Year	Application	Front				Rear			
		Magnum	Cab damper	Original equipment cross-reference	Mounting information	Magnum	Cab damper	Original equipment cross-reference	Mounting information
FAW									
All	6.130 FL (3.5T)								
All	8.140 FL (5T)								
All	15.180 FL (8T), 15.220 FL (8T)								
All	15.180 FT 4x2 (8T)								
All	28.290 FL (13.5T), 28.380 FT (6x4), 28.500 FT								
All	33.420 FT (6x4)								

FIAT									
00-0n	682 SWB Truck	<i>B0001</i> >	—	—	⊕ ⊖	—	—	—	
00-0n	RN130 Bus	<i>B0001</i> >	—	—	⊕ ⊖	—	—	—	

FORD									
All	Aeromax 106		—	—		65420	—	65420 OE # = 47902-28	⊕ ⊖
All	Aeromax 8000		—	—		65420	—	65420 OE # = 47902-28	⊕ ⊖
All	Aeromax 9500		—	—		<i>65418</i> > or <i>65419MM</i> or <i>65420</i> or <i>65103</i> (for '96-'97 models only)	—	65418 and 65419 OE# = 90045099 FGHT-18080-EA 65420 OE # = 47902-28 FGHT-18080-FC	⊕ ⊖
67-81	D.1000 Trucks	<i>T0009</i> >	—	—	⊥ T	—	—		
Mid 68-81	D.500, D.600, D.700, D.750, D.800	<i>T0009</i> >	—	—	⊥ T	—	—		
69-81	D.550	<i>T0009</i> >	—	—	⊥ T	—	—		
Mid 68-81	D.600, D.700, D.800 (Tractive Units)	<i>T0009</i> >	—	—	⊥ T	—	—		
Mid 68-81	DT. 800 Rigid 6 Wheeler	<i>T0009</i> >	—	—	⊥ T	—	—		
71-81	Single Axle : D.810 D.813 D.817 D.907 D.910 D.913, D.1010 D.1013 D.1113 D.1210 D.1211 D.1213 D.1214	<i>T0009</i> >	—	—	⊥ T	—	—		
71-81	Single Axle : D.1311 D.1314 (Where telescopic are fitted)	<i>T0009</i> >	—	—	⊥ T	—	—		
71-81	Single Axle Tippers : D.1311 D.1313 D.1314	<i>T0009</i> >	—	—	⊥ T	—	—		
71-81	Single Axle Trucks & Tippers : D.1411 D.1414	<i>T0009</i> >	—	—	⊥ T	—	—		
71-81	DA.1610 DA.1710 DA.1911 DA.2011 DA.2014	<i>T0009</i> >	—	—	⊥ T	—	—		
71-81	Tandem Axle : DT.1711 DT.2014 (Where telescopic are fitted)	<i>T0009</i> >	—	—	⊥ T	—	—		
All	F600, F700, F800, FT900 (FT series)	<i>"65482"</i>	—	65482 = OE#: F4HT-18045-EA	⊕ ⊖	65103	—	65411 = OE#: E9HS-18045-AA 65103 = OE #s: F4HT-18080-AA, F4HT-18080-AB, EGHT-18080-AA, F4HT-18080-AB, EGHT-18080-AA	65411 = ⊕ ⊖ 65103 = ○ ○
All	Louisville 8500, 9500		—			<i>65418</i> > or <i>65419MM</i> <i>65420</i> or <i>65103</i>	—	65418 & 65419 = OE#: 90045099 FGHT-18080-EA 65420 = OE #: 47902-28 FGHT-18080-FC 65103 = OE#s: XC45-18080-AA, F4HT-18080-AB, F4HT-18080-CA	65418 / 65419 / 65420 = ⊕ ⊖ 65103 = ○ ○
86-96	Triton (A.D.E. Engine)	<i>M4464</i>	—		⊥ ○	<i>M4441</i>	—		○ ○

Key

- * See important installation information on inside front cover
- ! Excluding self-leveling suspension
- "..." Special order - phone 010 900 1850. 6-12 week waiting period

- ~ Imported
- # Internal bump stop
- ⊕ Steering damper

- It is recommended that all new shock absorbers are fitted in pairs
- Do not mix gas and non-gas units on the same axle
- **Bold** part numbers indicate heavy-duty shocks
- Underlined part numbers indicate parts not immediately available
- *Italic* part numbers followed by > indicate parts to be discontinued
- *13 Check the OE part number on the old shock for the correct application

Truck, bus and trailer

Part number [alphabetical listing]

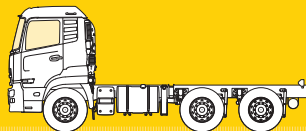

Year	Application	Front				Rear			
		Magnum	Cab damper	Original equipment cross-reference	Mounting information	Magnum	Cab damper	Original equipment cross-reference	Mounting information
FREIGHTLINER									
All	Freightliner Trucks: Argosy range, FL112, Century Class C112, C120, Columbia Class FLC112, FLD112, FLD120, M2	65148 OR 65103 OR 65490 OR 74073	66105MM	65148 OE #'s = 10-13021-000, 10-13063-000, 10-12703-000, 10-12704-000 65103 = OE#: 10-12046-000 66105MM = OE#: 1837813000 74425 OE# = 16-13957-000 74073 = OE#'s: 10-12046-000 10-13021-000 10-12032-002 10-12032-004 10-12030-002 10-12032-000 10-12032-001 10-12032-003	65148, 66105, 74425 & 74073 = ⊖ ⊖ 65103 = ⊖ ⊖ / 74425 = 19ID 74073 = 25ID 65103 = 25ID	65490 OR 65407MM OR "74433" OR 65148	—	65490 (& 74425) OE # = 16-13957-000 16-15817-000 16-13957-003 680339 65407 OE # = 16-12117-000 74433 OE # = 16-14259-000 16-16577-000 65148 OE #'s = 10-13021-000, 10-13063-000, 10-12703-000, 10-12704-000	65490 & 74433 & 65148 = ⊖ ⊖ 65407 = ⊖ ⊖
All	Freightliner C112, C120 CAB DAMPER		66118MM > OR 66147MM OR 66162MM	66118 OE# = 18-30378, 18-30378-000, 18-30398-000, 18-32999-000, 18-41762-000, 66147 OE# = 18-29846-000 66162 OE# = 1201-1043, 1201-1044, 1201-1043, 1202-1044, 1202-1043, 1202-1044, 1201-1049, 1202-0043	66147 & 66162 = ⊖ ⊖ 66118 = ⊖ ⊖		—		
All	Freightliner Trucks: FLA, FLB COE truck & tractor, FLC112, FLD112, FLD120	65103 OR 74073	—	65103 = OE#'s: 10-12030-002, 10-12032-000, 10-12032-000, 10-12032-001, 10-12032-002, 10-12032-003, 10-12032-004 74073 = OE#'s: 10-12046-000 10-13021-000 10-12032-002 10-12032-004 10-12030-002 10-12032-000 10-12032-001 10-12032-003	65103 = ⊖ ⊖ 74073 = ⊖ ⊖	65490 OR 65407MM OR "74433"	—	65490 OE # = 16-13957-000 16-15817-000 16-13957-003 680339 65407MM OE # = 16-12117-000 74433 OE # = 16-14259-000 16-16577-000	65490 & 74433 = ⊖ ⊖ 65407MM = ⊖ ⊖
	CAB DAMPER		66147MM OR 66104MM	66104 OE# = 1202-0054 66147 OE# = 18-29846-000	⊖ ⊖				
All	Freightliner Trucks: MB/FL 50, 60, 70, 80, FC70, FC80, Cargo, Classic, Classic XL class, Coronada class, Lagacy class.	65103 OR 65482"	—	65103 = OE#'s: 10-12032-002, 10-12032-004 65482 OE# = 680-323-0300, 665538	65482 = ⊖ ⊖ 65103 = ⊖ ⊖	65490	—	65490 OE # = 16-13957-000 16-15817-000 16-13957-003 680339	⊖ ⊖
All	Freightliner FL60, FL70 CAB DAMPER		66118MM > OR 66147MM OR 66104MM	66104 OE# = 1202-0054 66118 OE# = 18-30378, 18-30378-000, 18-30398-000, 18-32999-000, 18-30378-000, 18-41762-000 66147 OE# = 18-29846-000	66104 & 66147 = ⊖ ⊖ 66118 = ⊖ ⊖				
FRUEHAUF									
All	Fruehauf SA9, SA10, SA11 Trailer	—	—	—		F1241 *13 OR F5084 *13		F1241 OE# = M077800 UJB1147 F5084 OE# = 152685 1526855 M001537 M007950 M076480 M200052 M200133 UJB0364 UJB0563 UJB0565	⊖ ⊖

Key

*	See important installation information on inside front cover
!	Excluding self-levelling suspension
"..."	Special order – phone 010 900 1850. 6-12 week waiting period

~	Imported
#	Internal bump stop
⊖	Steering damper

- It is recommended that all new shock absorbers are fitted in pairs
- Do not mix gas and non-gas units on the same axle
- **Bold** part numbers indicate heavy-duty shocks
- Underlined part numbers indicate parts not immediately available
- *Italic* part numbers followed by > indicate parts to be discontinued
- *13 Check the OE part number on the old shock for the correct application

Truck, bus and trailer

Part number [alphabetical listing]

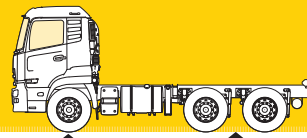

Year	Application	Front				Rear			
		Magnum	Cab damper	Original equipment cross-reference	Mounting information	Magnum	Cab damper	Original equipment cross-reference	Mounting information
FRUEHAUF <small>continued</small>									
All	Fruehauf TA Trailer	—	—	—		F5085	—	F5085 OE# = 126502007352 1518588 1521533 152786 1527867 23514 50370/0 680117 905180 BJB0180001 M007942 S09603030 S09605130 UCE1295 UCE1295/1 UJA0878001 UJB0177 UJB0177001 UJB0179 UJB0316 UJB0562 UJC0020 UJC0020/01 UJC0054 UJZ7093 W4012762	○ ○

GIGANT <small>Truck</small>									
All	Gigant Trailer	—	—			F5004	—	F5004 OE# = 00501300 00501310	○ ○
All	Gigant (SMB) SA9, SA10, SA11 Trailer	—	—	—		F1241 or F5084	—	F1241 OE# = M077800 UJB1147 F5084 OE# = 152685 1526855 M001537 M007950 M076480 M200052 M200133 UJB0364 UJB0563 UJB0565	⊖ ⊖
All	Gigant TA Trailer					F5085		OE# = M007942	⊖ ⊖
All	Gigant ZA9 Trailer	—	—			F5084		F5084 OE# = 152685 1526855 M001537 M007950 M076480 M200052 M200133 UJB0364 UJB0563 UJB0565	⊖ ⊖

HENDRICKSON <small>Truck</small>									
All	Hendrickson trailer (various) *13 Check OE #'s	—	—	—		"65485MM"	—	OE# = 59305-1	⊖ ⊖
All	Hendrickson trailer (various) *13 Check OE #'s	—	—	—		"F5015"		OE# = 508571 AM758571 Y508571	⊖ ⊖ (air susp)

- Key**
- * See important installation information on inside front cover
 - ! Excluding self-levelling suspension
 - "..." Special order – phone 010 900 1850. 6-12 week waiting period

- ~ Imported
- # Internal bump stop
- ⊖ Steering damper

- It is recommended that all new shock absorbers are fitted in pairs
- Do not mix gas and non-gas units on the same axle
- **Bold** part numbers indicate heavy-duty shocks
- Underlined part numbers indicate parts not immediately available
- *Italic* part numbers followed by > indicate parts to be discontinued
- *13 Check the OE part number on the old shock for the correct application

Truck, bus and trailer

Part number [alphabetical listing]

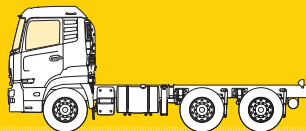

Year	Application	Front				Rear			
		Magnum	Cab damper	Original equipment cross-reference	Mounting information	Magnum	Cab damper	Original equipment cross-reference	Mounting information
HINO									
00-0n	FD Series	M4464	—	—	⊥ ○	—	—	—	—
00-0n	FE Series	<i>T1250</i> >	—	—	⊥ ○	—	—	—	—
00-0n	FF & FG Series	—	—	—	⊖ ⊖ (21.5ID)	—	—	—	—
72-83	KL 340, KL360	M4464	—	—	⊥ ○	—	—	—	—
90-98	Super Dolphin (Horse), UH30	—	—	—	⊖ ⊖	—	—	—	—
All	300 611, 300 614, 300 711, 300 714 (MY10 & MY12), 300 811, 300 814 (MY10 & MY12), 300 815, 300 915	65103	—	—	⊖ ⊖ (25mm ID, closed 415mm, open 669mm)	—	—	—	—
97-on	500 (1626 series)	"65407MM" > 65103	—	—	⊖ ⊖	"65484MM"	—	—	⊖ ⊖

TOYOTA TRUCKS – see "Toyota"

HOLLAND									
All	Holland truck & tractor AD246 & AD247 with air susp	—	—	—	—	65418 >	—	OE# = 900-45-099 / 900-45-534	⊖ ⊖

INTERNATIONAL									
All	International Trucks: F & S Series, 2000 series, 4000, series, 7100 (Check OE #'s)	65103	—	65103 = OE #: 453576C92	○ ○	65409	—	65409 = OE #'s: 501553C01, 1675455C1, 1690035C1, 2018987C1	⊖ ⊖
All	International Trucks 4200 4300 4400 series	65144MM	—	65144 OE#'s = 3533357C1, 3588209C1, 3602060C1	⊖ ⊖	—	—	—	—
All	International Trucks 7300, 7400, 7500, 7600 series	—	—	—	—	—	—	—	—
	CAB DAMPER	—	66161MM or 66162MM	66161 OE# = 2509222C91 2509224C91 3557165C1 3557167C3 3560705C2 66162 OE# = 1201-1043, 1201-1044, 1201-1043, 1202-1044, 1202-1043, 1202-1044, 1201-1049, 1202-0043	⊖ ⊖	—	—	—	—
All	International Trucks: 4900, 8100, 8200, 8300, 9100, 9200, 9300, 9400, 9600, 9700, 9900 (Check OE #'s)	65107	—	65107 = OE #'s: 2015556C1, 1664788C2, 3571713C1, 2032533C1	⊥ ⊖	65409 or 65488MM or "74420"	—	65409 = OE #'s: 501553C01, 1675455C1, 1690035C1, 2018987C1 65488 = OE #: 3544768C1 3549100C1 3578858C1 74420 = OE # 501553C91 167545455C1 1690035C1 2018987C1	⊖ ⊖
	CAB DAMPER	—	66104MM or 66161MM or 66162MM	66104 OE# = 1202-0054 66161 OE# = 2509222C91 2509224C91 3557165C1 3557167C3 3560705C2 66162 OE# = 1201-1043, 1201-1044, 1201-1043, 1202-1044, 1202-1043, 1202-1044, 1201-1049, 1202-0043	66104 & 66161 & 66162 = ⊖ ⊖	—	—	—	—
All	International Trucks 9800i series	—	—	—	—	65420 (98000 SBA)	—	65420 = OE #: 47902-024	⊖ ⊖
All	International Trucks: 5500i, 5600i, 5900i (HAS-230 susp), / 7300, 7400, 7500, 7600 (Drive axles) / 9100i, 9200i, 9400i (HAS-230/400/460 susp Drive Axles) / 9900i, 9900ix (HAS-230/400/460 susp Drive Axles) – Check OE #'s)	—	—	—	⊖ ⊖	65420 or 65492 or 65488MM	—	65420 = OE #: 47902-024 65492 OE#'s = 3573265C, 3549099C2 65488 = OE #: 3544768C1 3549100C1 3578858C1	⊖ ⊖

Key

*	See important installation information on inside front cover
!	Excluding self-levelling suspension
"..."	Special order – phone 010 900 1850. 6-12 week waiting period

~	Imported
#	Internal bump stop
⊖	Steering damper

- It is recommended that all new shock absorbers are fitted in pairs
- Do not mix gas and non-gas units on the same axle
- **Bold** part numbers indicate heavy-duty shocks
- Underlined part numbers indicate parts not immediately available
- *Italic* part numbers followed by > indicate parts to be discontinued
- *13 Check the OE part number on the old shock for the correct application

Truck, bus and trailer

Part number [alphabetical listing]

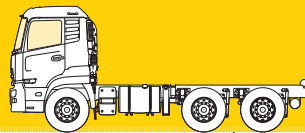

Year	Application	Front				Rear			
		Magnum	Cab damper	Original equipment cross-reference	Mounting information	Magnum	Cab damper	Original equipment cross-reference	Mounting information
INTERNATIONAL <i>continued</i>									
	CAB DAMPER		66161MM OR 66162MM	66161 OE# = 2509222C91 2509224C91 3557165C1 3557167C3 3560705C2 66162 OE# = 1201-1043, 1201-1044, 1201-1043, 1202-1044, 1202-1043, 1202-1044, 1201-1049, 1202-0043	66161 & 66162 = ⊖ ⊖	–	–		
All	International Trucks: Transtar, Transtar II, Co-Transtar, Metro, MultiStop, 1000, Paystar series, 8500, 8600	65103	–	65103 = OE #: 453576C92	⊖ ⊖	65492	–	65492 OE#'s = 3549099C2	⊖ ⊖
		65144MM	–	65144 OE#'s = 3533357C1, 3588209C1, 3602060C1	⊖ ⊖		–		
All	International Trucks: Prostar air suspension		–			65492	–	65492 OE#'s = 3620395C	⊖ ⊖

INTERNATIONAL									
All	International 3200 Bus	–	–			65488MM	–	65488 OE#'s = 3544768C1 3549100C1 3578858C1	⊖ ⊖

ISUZU									
EVR									
Various	EVR Series	66625MM >	–	Check OE #'s 66625 OE#'s = 1-51630-180-3	⊖ ⊖	–	–		
FRR									
97-on	FRR 500 F-C	"66601MM"	–	Check OE #'s 66601 OE#'s = 1-51630-219-1	⊥ ⊖	–	–		
FSR									
FSR & FTR									
97-on	FSR 700 F-C and FTR 800 F-C	"74081MM" OR "66677MM"	–	Check OE #'s 74081MM OE# = 8-22064-805-0 / 8-22064-806-0 / 8-22064-807-0 66677MM OE# = 1516302171	74081 = ⊥ ⊥	"66626MM" OR "66605MM"	–	Check OE #'s 66626 OE# = 8-22064-232-0 / 66605MM OE3 = 1516301670	⊥ ⊥
FVR									
97-on	FVR 900T F-C	74081MM > OR 66625MM > OR "66677MM"	–	Check OE #'s 74081MM OE# = 8-22064-805-0 / 8-22064-806-0 / 8-22064-807-0 66625MM OE# = 1516301600 / 1516301803 66677MM OE# = 1516302171	74081MM = ⊥ ⊥ 66625MM = ⊖ ⊖	"66626MM" OR "66605MM"	–	Check OE #'s 66626MM OE# = 8-22064-232- 0 / 66605MM OE3 = 1516301670	⊥ ⊥
N Series									
All	N3500D, N4000D		–	–		B0001 >			⊖ ⊖
NKR									
All	NKR series	–	–			"66618MM"	–	Check OE# = 8516306660 / 9516306662 / 8972536640 / 8972536510	⊖ ⊖
NMR									
08-on	NMR 250 5.2ton medium truck	66639MM			⊥ ⊖				
NPR									
All	NPR 275 5.8ton, NPR 300 6.2ton medium truck	66675MM OR "66653MM" OR "66717MM" OR "66601MM"	–	Check OE #'s 66675 = 1-51630-200-0 66653 = 8-97253-621-0 / 8-97083-029-0 66717 = 8-97201-960-0 / 8-94454- 986-0 / 8-94454-987-0 / 9-51630-647-1 66601 = 1-51630-219-1	"66675" / "66653" / "66717" = ⊥ ⊖ "66601" = ⊥ ⊖	"66618MM"	–	Check OE# = 8516306660 / 9516306662 / 8972536640 / 8972536510	⊖ ⊖

Key	
*	See important installation information on inside front cover
!	Excluding self-levelling suspension
"..."	Special order – phone 010 900 1850. 6-12 week waiting period

~	Imported
#	Internal bump stop
⊖	Steering damper

- It is recommended that all new shock absorbers are fitted in pairs
- Do not mix gas and non-gas units on the same axle
- **Bold** part numbers indicate heavy-duty shocks
- Underlined part numbers indicate parts not immediately available
- *Italic* part numbers followed by > indicate parts to be discontinued
- *13 Check the OE part number on the old shock for the correct application

Truck, bus and trailer

Part number [alphabetical listing]

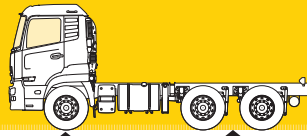

		Front				Rear			
Year	Application	Magnum	Cab damper	Original equipment cross-reference	Mounting information	Magnum	Cab damper	Original equipment cross-reference	Mounting information
ISUZU <i>continued</i>									
NPS									
08-on	NPS 300 6.0ton & 6.2ton medium truck								
NPR									
08-on	NPR 400 7.5ton medium truck								
NQR									
08-on	NQR 500 8.5ton medium truck					M8056			⊖ ⊖
NRR									
All	NRR series	"66677MM" OR "66601MM"	-	Check OE# 66677MM = 1516302171 / 66601MM = 1-51630-219-1	⊥ ⊖		-	-	
W									
Various	W Series	66625MM >	-	Check OE #s 66625 OE#s = 1-51630-180-3	⊖ ⊖	-	-		

IVECO									
All	ERF ECT	T1318	CB0199	-	T1318 = ⊥ ⊖ CB0199 = ⊖ ⊖				
All	Eurostar / Eurotech	T1261	-	T1261 OE# = 41033038 41214460 41214818	⊥ ⊖	T5269	-	T5269 OE# = 41033039 41214461 41214700 41225418 41296211 41296216	T5269 = ⊖ ⊖ (air)
All	Eurotrakker	-	-			T5269	-	T5269 OE# = 41033039 41214461 41214700 41225418 41296211 41296216	T5269 = ⊖ ⊖ (air)
All	Stralis	T1261	-	T1261 OE# = 41033038 41214460 41214818	T1261 = ⊥ ⊖	T5269	-	T5269 OE# = 41033039 41214461 41214700 41225418 41296211 41296216	T5269 = ⊖ ⊖ (air)
All	Stralis 190Sxx Series, 260Sxx Series, 320Sxx Series, 440Sxx Series	-	CB0137 (AT & AS) CB0154 (AT)	CB0136 OE# = 500340705 500357351 CB0154 OE# = 500392874 504047432 504080349 504084379 504115381	CB0137 (air) CB0154 (incl spring) ALL = ⊖ ⊖	-	CB0136 (AS) CB0149 (AD & AT) CB0152 (AD)	CB0136 OE# = 500340706 500357352 CB0149 OE# = 504060233 504060241 CB0152 OE# = 504055167 504055168 504080440 504084380 504115382	⊖ ⊖ CB0149 (air) CB0152 (coil)

Key

*	See important installation information on inside front cover
!	Excluding self-levelling suspension
...	Special order - phone 010 900 1850. 6-12 week waiting period

~	Imported
#	Internal bump stop
⊖	Steering damper

- It is recommended that all new shock absorbers are fitted in pairs
- Do not mix gas and non-gas units on the same axle
- **Bold** part numbers indicate heavy-duty shocks
- Underlined part numbers indicate parts not immediately available
- *Italic* part numbers followed by > indicate parts to be discontinued
- *13 Check the OE part number on the old shock for the correct application

Truck, bus and trailer

Part number [alphabetical listing]

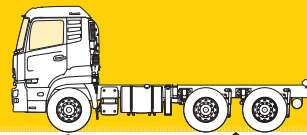

Year	Application	Front				Rear			
		Magnum	Cab damper	Original equipment cross-reference	Mounting information	Magnum	Cab damper	Original equipment cross-reference	Mounting information
JMC (JIANGLING MOTOR CORP)									
Carrying									
10-on	Carrying MCV dropside (1.3 ton & 2.8 ton) & 2.8D 2 ton SWB & 3 ton LWB	M4464			⊥ ○	M4464			⊥ ○
19-on	Carrying Plus LCV (4 ton)								
KENWORTH									
All	Kenworth Trucks: K300, T300, T600, T800, W900		—		⊖ ⊖	65420 OR "74409"	—	65420 OE # = 47902-24 74409 OE # = K374-7, K374-9, K374-29, K374-32	65420 = ⊖ ⊖ 74409 = ⊥ ⊥
	CAB DAMPER	—	66104MM	OE# = 1202-0054 / 1201-1046	⊖ ⊖	—	—	—	—
All	Kenworth Trucks: C500, C500B, C500K, C540, C55, K100, K100E, K125, T400, T400B, T450B, T600A, T600B, T602., T800A, T800B, T800SH, T800H, T800W, T2000 Aerodyne 112, 120, W900B, W900L, W900S.		—		⊖ ⊖	"74409"	—	74409 OE # = K374-7, K374-9, K374-29, K374-32	74409 = ⊥ ⊥
	CAB DAMPER	—	66104MM	OE# = 1202-0054 / 1201-1046	⊖ ⊖				
LECINENA									
All	Lecinena Trailers	—	—	—		F5004	—	—	⊖ ⊖
LECITRAILER									
All	Lecitrailer	—	—	—		F5004 *13 OR "F5007" *13	—	F5004 = OE#s: 0237025200 F5007 = OE#s: 5180021	⊖ ⊖ F5004 (ID= 24mm, closed 326mm, open 496mm), F5007 (ID = 24mm, closed 426, open 694mm)
LEYLAND									
63-72	Clydesdale Bus	T0009 >	—	—	⊥ ⊥	—	—	—	
63-72	Retriever	T0009 >	—	—	⊥ ⊥	—	—	—	
MACK									
All	Mack Trucks: CH600, CL600, CL700, CX Vision Series	65103	—	65103 = OE #: 140K-392AM2	○ ○	65418 > OR 65419MM OR 65420	—	65418 & 65419 OE# = 140K-414M / 140K-414M2 65420 OE# = 140K-410M2	⊖ ⊖
All	Mack Trucks: MH, R, RW series	65103	—	65103 = OE #s: 140K-373, 140K-377M, 140K-378M, 140K-2110, 140K-2110-P1	○ ○		—		

Key

*	See important installation information on inside front cover
!	Excluding self-levelling suspension
"..."	Special order – phone 010 900 1850. 6-12 week waiting period

~	Imported
#	Internal bump stop
⊖	Steering damper

- It is recommended that all new shock absorbers are fitted in pairs
- Do not mix gas and non-gas units on the same axle
- **Bold** part numbers indicate heavy-duty shocks
- Underlined part numbers indicate parts not immediately available
- *Italic* part numbers followed by > indicate parts to be discontinued
- *13 Check the OE part number on the old shock for the correct application

Truck, bus and trailer

Part number [alphabetical listing]

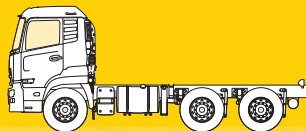

Year	Application	Front				Rear			
		Magnum	Cab damper	Original equipment cross-reference	Mounting information	Magnum	Cab damper	Original equipment cross-reference	Mounting information
MAN									
Man 6, 8, 9									
All	Man 6.90, 6.100, 8.90, 8.100, 8.136, 8.150, 9.100, 9.135, 9.136, 9.150	T1142	—	T1142 OE# = 81437016354	⊥ T	—	—		
Man (F8) 13, 14, 15, 16, 17, 19, 22, 24, 25, 26									
All	Man 13.192U, 14.192U, 15.192U, 16.291, 16.320U, 16.320UL, 16.321, 16.321U, 16.321UL, 16.361, 17.220FA, 17.240FA, 19.291, 19.320U, 19.321, 19.321U, 19.361, 22.291UNL/LL, 22.320UNL, 22.321UNL, 22.331UNL/LL, 22.361UNL/LL, 24.291UNL/LL, 24.331UNL/LL, 24.361UNL/LL, 25.291UNL/LL, 25.331UNL/LL, 25.361UNL/LL, 26.291UNL/LL, 26.331UNL/LL, 26.361UNL/LL		CB0141	CB0141 OE# 81 43701 6241 81 43701 6291 81 43701 6331 88 41701 0012	CB0141 = ⊖ ⊖ (incl spring)	—			
Man 18, 19, 21									
All	Man 18, 19, 21	T1189 OR T1190	—	T1189 OE# = 81437016793 T1190 OE# = 81437016794	⊥ ⊖	T5429 OR "T5263"	—	T5429 OE# 81437016564/ 81437016584/ 81437016585/ 81437016620/ 81437016220 T5263 OE# 81437016905	T5429 & T5263 = ⊖ ⊖
Man 17, 22, 23, 26									
All	Man 17, 22, 23, 26	"T1028"	—	T1028 OE# = 81437016442/ 81437016444/ 81437016456/ 81437016457/ 81437016490/ 81437016491/ 81437016695	⊥ ⊖	T5121 > OR T5429 OR T5047	—	T5121 OE# 81437016752/ 81437016796/ T5429 OE# 81437016564/ 81437016584/ 81437016585/ 81437016620/ 81437016220 T5047 OE# 81437016605	⊖ ⊖
Man 14, 16, 19, 22, 24, 25, 26, 30, 32, 33, 38, 40, 41, 48									
96-99	Man 14, 16, 19, 22, 26, 30, 32, 33, 38, 40, 41, 48 (Check OE #'s)	"T1028" OR T1190 OR T1029	—	T1028 OE# = 81437016442/ 81437016444/ 81437016456/ 81437016457/ 81437016490/ 81437016491/ 81437016695 T1190 OE# = 81437016794 T1029 OE# = 81437016699	T1028 & T1190 & T1029 = ⊥ ⊖	T1039 > OR T5121 > OR "T5048" OR T5429 OR T5047	—	T1039 OE# = 81437016464 T5121 OE# 81437016752/ 81437016796/ T5048 OE# 81437016634 T5429 OE# 81437016564/ 81437016584/ 81437016585/ 81437016620/ 81437016220 T5047 OE# 81437016605	T1039 = ⊥ T T5121 & T5048 & T5429 & T5047 = ⊖ ⊖

Key

*	See important installation information on inside front cover
!	Excluding self-levelling suspension
"..."	Special order – phone 010 900 1850. 6-12 week waiting period

~	Imported
#	Internal bump stop
⊖	Steering damper

- It is recommended that all new shock absorbers are fitted in pairs
- Do not mix gas and non-gas units on the same axle
- **Bold** part numbers indicate heavy-duty shocks
- Underlined part numbers indicate parts not immediately available
- *Italic* part numbers followed by > indicate parts to be discontinued
- *13 Check the OE part number on the old shock for the correct application

Truck, bus and trailer

Part number [alphabetical listing]

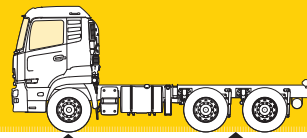

Year	Application	Front				Rear			
		Magnum	Cab damper	Original equipment cross-reference	Mounting information	Magnum	Cab damper	Original equipment cross-reference	Mounting information
MAN continued									
MAN TGA 18., 19., 24., 26., 28., 32., 33., 35., 40., 41.									
All	TGA: 18., 19., 24., 26., 28., 32., 33., 35., 40., 41.	"T1267" OR "T1268" OR "T1028" OR T1308 OR T1318 OR T1320 OR T1321 OR T1333 OR T1353	CB0199 OR CB0201	T1267 OE# = 81437016949/ 81437016991 T1268 OE# = 81437016897/ 81437016948 T1308 OE# = 81437026004 81437026005 81437026014 81437026078 81437026086 T1028 OE# = 81437016442/ 81437016444/ 81437016456/ 81437016457/ 81437016490/ 81437016491/ 81437016695 T1318 OE# = 81437016964 T1320 OE# = 81437026002 81437026003 81437026077 81437026011 81437026012 81437026076 T1333 OE# = 81437026058 T1353 OE# = 81437016995 CB0199 OE# = 85417226010 85417226017 CB0201 OE# = 81417226060	T1267, T1268, T1318 = ⊥ ⊕ (24ID), T1266, T1028 = ⊥ ⊕ (16ID), T1308, T1320, T1321, T1333 ⊕ ⊕ (top ID 20mm, btm ID 24mm), T1353 ⊕ ⊕ (top ID 20mm, btm ID 16mm) CB0199, CB0201 = ⊕ ⊕ (w/spring)	"T5048" OR "T5263" OR T5261 OR T5276 OR T5277 OR T5349 OR T5350 OR T5400 OR T5266 OR "T5262" OR T5275	CB0103 OR CB0139 OR CB0141 OR CB0197 OR CB0198 OR "CB0091"	T5048 OE# 81437016634 T5263 OE# 81437016905 T5261 OE# 81437016904 T5276 OE# 81437016911 81437016912 81437026119 T5277 OE# 81437016926 T5349 OE# 81437016868 T5350 OE# 81437016934 81437026016 T5400 OE# 81437016965 81437026055 81437026116 T5266 OE# 81437016944 T5262 OE# 81437016950 T5275 OE# 81437016908 81437026037 CB0103 OE# 81437016629 CB0139 OE# 85 41722 6001 CB0141 OE# 81 43701 6241 CB0197 OE# 81417226061 CB0198 OE# 81417226059 85417226011 85417226019 CB0091 OE# 81 41722 6049 81 41722 6052	T5048, T5263, T5261, T5400, T5262, T5275 (air susp, drive axle) = ⊕ ⊕ (top ID 20mm, btm ID 30mm) / T5276 (air susp, trailing axle) / T5277 (air & leaf susp, drive axle) & T5349, T5350, T5266 (air susp, drive axle) = ⊕ ⊕ (20ID) CB0103 (INCL spring) ⊕ ⊕ (ID 14mm) CB0139 (INCL spring) ⊕ ⊕ (ID 14mm) CB0141 (INCL spring) ⊕ ⊕ (ID 14mm) CB0197 (INCL spring) ⊕ ⊕ (ID 12mm) CB0198 (INCL spring) ⊕ ⊕ (ID 12mm) CB0091 (INCL airspring) ⊕ ⊕ (ID 14mm)
MAN 41									
All	41		-			"T5263"	-	T5263 OE# 81437016905	⊕ ⊕
MAN E2000									
All	E2000					T5277 OR T5349		T5277 OE# 81437016926 T5349 OE# 81437016868	T5277 = ⊕ ⊕ (air & leaf susp drive axle) T5349 = ⊕ ⊕ (air susp)
MAN F90									
All	F90	T1093	CB0106	T1093 OE# 81437016597 81437016598 81437016612 CB0106 OE# 81 41722 6009 81 41722 6012 81 41722 6033 81 41722 6037	T1093 = ⊥ ⊥ CB0106 = ⊕ ⊥ (coil)	T5386 OR T5429	CB0105	T5386 OE# 81437016594 81437016757 T5429 OE# 814307026132 CB0105 OE# 81 41722 6017 81 41722 6045	T5386 = ⊥ ⊕ T5429 (air & leaf susp), CB0105 = ⊕ ⊕
MAN F2000									
All	F2000	-	CB0092 OR CB0106	CB0092 OE# 81417226048 81417226051 CB0106 OE# 81 41722 6009 81 41722 6012 81 41722 6033 81 41722 6037	CB0092 = ⊕ ⊥ (air) CB0106 = ⊕ ⊥ (coil)	T5277 OR T5349 OR T5350 OR T5386 OR T5429	CB0103 OR CB0105	T5277 OE# 81437016926 T5349 OE# 81437016868 T5350 OE# 81437016934 81437026016 T5386 OE# 81437016594 81437016757 T5429 OE# 814307026132 CB0103 OE# 81437016629 CB0105 OE# 81 41722 6017 81 41722 6045	T5277, T5429 ⊕ ⊕ (air & leaf susp drive axle) / T5349 = ⊕ ⊕ (air susp) / T5350 = ⊕ ⊕ (leaf susp) / T5386 = ⊥ ⊕ CB0103 & CB0105 ⊕ ⊕ (coil)

Key

*	See important installation information on inside front cover
!	Excluding self-levelling suspension
...	Special order - phone 010 900 1850. 6-12 week waiting period

~	Imported
#	Internal bump stop
⊕	Steering damper

- It is recommended that all new shock absorbers are fitted in pairs
- Do not mix gas and non-gas units on the same axle
- **Bold** part numbers indicate heavy-duty shocks
- Underlined part numbers indicate parts not immediately available
- *Italic* part numbers followed by > indicate parts to be discontinued
- *13 Check the OE part number on the old shock for the correct application

Truck, bus and trailer

Part number [alphabetical listing]

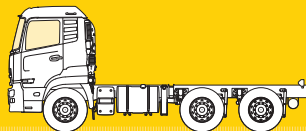

Year	Application	Front				Rear			
		Magnum	Cab damper	Original equipment cross-reference	Mounting information	Magnum	Cab damper	Original equipment cross-reference	Mounting information
MAN continued									
MAN L2000									
All	L2000	—	CB0106	CB0106 OE# 81 41722 6009 81 41722 6012 81 41722 6033 81 41722 6037	⊖ ⊕ (coil)	—	CB0103 OR CB0105 OR CB0139 OR CB0141	CB0103 OE# 81437016629 CB0105 OE# 81 41722 6017 81 41722 6045 CB0139 OE# 85 41722 6001 CB0141 OE# 81 43701 6241	⊖ ⊖ (coil)
MAN M90									
All	M90	T1093 OR "B1278"		T1093 OE# 81437016597 81437016598 81437016612 B1278 OE# 81437016672 81437016689 81437016706 81437016714 81437016730 81437016768 81437016801 81437016806	T1093, B1278 = ⊥ ⊕	—	CB0103 OR CB0139 OR CB0141	CB0103 OE# 81437016629 CB0139 OE# 85 41722 6001 CB0141 OE# 81 43701 6241	⊖ ⊖ (coil)
MAN M2000									
All	M2000	"T1189"		"T1189" OE# = 81437016793, 81437016793, 81437016804	⊥ ⊖	T5429 OR "T1093"	CB0103 OR CB0139	T5429 OE# 814307026132C "T1093" = 81437016597, 81437016598, 81437016612, 81437016597, 81437016598, 81437016612, 81437016600, B0103 OE# 81437016629 CB0139 OE# 85 41722 6001	T5429 (open 648mm) = ⊖ ⊖ (leaf OR air susp) T1093 (opens to 692mm) = ⊥ ⊕ CB0103, CB0139 = ⊖ ⊖ (coil)
MAN TGL									
All	TGL	T1322		T1322 OE# = 85437016006	T1322 = ⊥ ⊖	T1313 air susp T1344 leaf susp		T1313 OE# 81437026000 T1344 OE# 85437016007	T1313 ⊖ ⊖ (16ID) T1344 ⊖ (12) ⊖ (16)
MAN TGM									
All	TGM	T1346 OR T1359		T1346 OE# = 85437016014 T1359 OE# = 85437016020	T1346 ⊖ ⊖ (leaf susp) T1359 ⊥ ⊖ (air susp)	T5349 OR T5400 OR T5406		T5349 OE# 81437016868 T5400 OE# 81437016965 81437026055 81437026116 T5406 OE# 81437026030 81437026048 85437016035	T5349 = ⊖ (20ID) ⊖ (20ID) (leaf susp drive axle) / T5400 & T5406 (air susp drive axle) = ⊖ (20ID) ⊖ (30ID)
MAN TGS 18., 19., 24., 26., 28., 32., 33., 35., 40., 41.									
All	TGS: 18., 19., 24., 26., 28., 32., 33., 35., 40., 41.	T1308 OR T1320 OR T1321 OR T1333	CB0199 OR CB0201	T1308 OE# = 81437026004 81437026005 81437026014 81437026078 81437026086 T1320 OE# = 81437026002 81437026003 81437026077 81437026085 T1321 OE# = 81437026011 81437026012 81437026076 T1333 OE# = 81437026058 CB0199 OE# = 85417226010 85417226017 CB0201 OE# = 81417226060	T1308 / T1320 / T1321 / T1333 ⊖ (20IDx105) ⊖ (24IDx55), CB0199 & CB0201 = ⊖ ⊖ (w/spring)	T5261 OR T5277 OR T5349 OR T5350 OR T5400 OR T5266 OR "T5262" OR T5275		T5261 OE# 81437016904 T5277 OE# 81437016926 T5349 OE# 81437016868 T5350 OE# 81437016934 81437026016 T5400 OE# 81437016965 81437026055 81437026116 T5266 OE# 81437016944 T5262 OE# 81437016950 T5275 OE# 81437016908 81437026037	T5261, T5400, T5262, T5275 (air susp, drive axle) ⊖ ⊖ (top ID 20mm, btm ID 30mm) / T5277 & T5349 & T5350 (leaf susp, drive axle) = ⊖ ⊖ (ID 20mm) / T5266 (air susp) ⊖ ⊖ (ID 20mm)

Key

*	See important installation information on inside front cover
!	Excluding self-levelling suspension
"..."	Special order – phone 010 900 1850. 6-12 week waiting period

~	Imported
#	Internal bump stop
⊖	Steering damper

- It is recommended that all new shock absorbers are fitted in pairs
- Do not mix gas and non-gas units on the same axle
- **Bold** part numbers indicate heavy-duty shocks
- Underlined part numbers indicate parts not immediately available
- *Italic* part numbers followed by > indicate parts to be discontinued
- *13 Check the OE part number on the old shock for the correct application

Truck, bus and trailer

Part number [alphabetical listing]

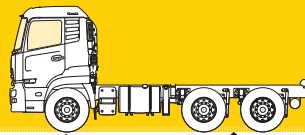

M

Year	Application	Front				Rear			
		Magnum	Cab damper	Original equipment cross-reference	Mounting information	Magnum	Cab damper	Original equipment cross-reference	Mounting information
MAN continued									
MAN TGX									
All	TGX	T1308 OR T1320 OR T1321 OR T1333		T1308 OE# = 81437026004 81437026005 81437026014 81437026078 81437026086 T1320 OE# = 81437026002 81437026003 81437026077 81437026085 T1321 OE# = 81437026011 81437026012 81437026076 T1333 OE# = 81437026058	T1308 / T1320 / T1321 / T1333 ⊖ (20IDx105) ⊖ (24IDx55)	T5261 OR T5400 OR T5266 OR "T5262" OR T5275		T5261 OE# 81437016904 T5400 OE# 81437016965 81437026055 81437026116 T5266 OE# 81437016944 T5262 OE# 81437016950 T5275 OE# 81437016908 81437026037	T5261, T5400, T5262, T5275 (air susp, drive axle) ⊖ ⊖ (top ID 20mm, btm ID 30mm) / T5266 (air susp) ⊖ (ID 20mm)
MAN TRAKKER									
All	Man Trakker 180Txx Series, 190Txx Series, 260Txx Series, 340Txx Series, 380Txx Series, 400Txx Series, 410Txx Series, 440Txx Series, 720Txx Series		CB0154 (AT)	CB0154 OE# = 500392874 504047432 504080349 504084379 504115381	CB0154 (incl spring) ⊖ ⊖	CB0149 (AD & AT) CB0152 (AD)		CB0149 OE# 504060233 504060241 CB0152 OE# 504055167 504055168 504080440 504084380 504115382	⊖ ⊖ CB0149 (air) CB0152 (coil)
MAN BUS									
MAN NG, NL, NU, EL Bus									
All	Man NG, NL, NU, EL Bus					"B1278"		B1278 OE# 81 43701 6672 81 43701 6689 81 43701 6706 81 43701 6714 81 43701 6730 81 43701 6768 81 43701 6801 81 43701 6806	B1278 = ⊥ ⊥
MERCEDES-BENZ									
All	Atego 1: 712, 714, 715, 717, 812, 814, 815, 817, 823	T1255 OR T1220 OR T5360	CB0220	T1255 OE# = 970323000 / 970320300 / 970320700 / A9703230300 T1220 OE# = 0033232000 0033232100 0043235600 0063235100 0063236000 0063237800 0063237900 3573230000 3753230000 A0063235100 T5360 OE# = 0053239900 0063238300 A0053239900 A0063238300 CB0220 OE# 9583170503 9583170603 9703171703 9703171803 9703174103 9703174203 A9583170503 A9583170603 A9703171703 A9703171803 A9703174103 A9703174203	T1255, T1220, T5360 (air susp) = ⊖ ⊖ CB0220 = ⊖ ⊖ (top mt ID 50mm, btm mt ID 14mm)	T1256 OR T1273	"CB0277" (incl spring)	T1256 OE#s: 9703260000 / 9703260200 / 9703260700 / A9703260200 T1273 OE#s: 9703260100 A9703260100 CB0277 OE#s : 9673170203, A9673170203, 9408901719, A9408901719	T1256 = ⊖ ⊖ (21.5ID) T1273 = ⊖ ⊖ (16ID) CB0277 = ⊖ ⊗
All	408, 409, 410, 508, 608, 613	V1095	—	33236000	⊖ ⊖	—	—		

Key	
*	See important installation information on inside front cover
!	Excluding self-levelling suspension
"..."	Special order – phone 010 900 1850. 6-12 week waiting period

~	Imported
#	Internal bump stop
⊖	Steering damper

- It is recommended that all new shock absorbers are fitted in pairs
- Do not mix gas and non-gas units on the same axle
- **Bold** part numbers indicate heavy-duty shocks
- Underlined part numbers indicate parts not immediately available
- *Italic* part numbers followed by > indicate parts to be discontinued
- *13 Check the OE part number on the old shock for the correct application

Truck, bus and trailer

Part number [alphabetical listing]

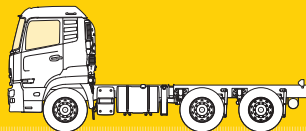

Year	Application	Front				Rear				
		Magnum	Cab damper	Original equipment cross-reference	Mounting information	Magnum	Cab damper	Original equipment cross-reference	Mounting information	
MERCEDES-BENZ continued										
All	800 series	—	—				"CB0080"	CB0080 OE # = 673 317 0103 673 317 0203 673 317 0303	⊖ ⊖	
All	Atego 914, 917, 923, 1017, 1023	T1255 OR T1220 OR T5360	CB0220	T1255 OE# = 970323000 / 970320300 / 970320700 / A9703230300 T1220 OE# = 0033232000 0033232100 0043235600 0063235100 0063236000 0063237800 0063237900 3573230000 3753230000 A0063235100 T5360 OE# = 0053239900 0063238300 A0053239900 A0063238300 CB0220 OE# 9583170503 9583170603 9703171703 9703171803 9703174103 9703174203 A9583170503 A9583170603 A9703171703 A9703171803 A9703174103 A9703174203	T1255, T1220, T5360 (air susp) = ⊖ ⊖ CB0220 = ⊖ ⊖ (top mt ID 50mm, btm mt ID 14mm)		T1256 OR T1273	"CB0080" OR "CB0277" (incl spring) OR "CB0278" (incl spring)	T1256 OE#s: 9703260000 / 9703260200 / 9703260700 / A9703260200 T1273 OE#s: 9703260100 A9703260100 CB0080 OE # = 673 317 0103 673 317 0203 673 317 0303 CB0277 OE # = 9673170203, A9673170203, 9408901719, A9408901719 CB0278 OE # = 9673170603, A9673170603	T1256 = ⊖ ⊖ (ID 21.5mm) T1273 = ⊖ ⊖ (ID 16mm) CB0080 = ⊖ ⊖ (ID 12mm) CB0277, CB0278 = ⊖ ⊗
All	Atego, 1013, 1017, 1019, 1213, 1214, 1215, 1216, 1217, 2018, 1219, 1222, 1223, 1224, 1225, 1226, 1228, 1229, 1420, 1422, 1424	T1204	—	T1204 OE# = 001 323 1100/ 002 323 1000/ 002 323 1100/ 002 323 1600/ 002 323 5400/ 003 323 1000/ 004 323 3600/ 004 323 4900/ 004 323 6500/ 005 323 9500/ 006 323 3700/ 006 323 6100/ A005 323 9500	⊖ ⊖	T5054 > OR T1256 OR T5403	CB0104 OR "CB0278"	T5054 OE# = 002 326 4600 002 326 4700 003 326 4500 003 326 9200 385 326 0100 T1256 OE#s: 9703260000 / 9703260200 / 9703260700 / A9703260200 T5403 OE#s: 0063262000 / 0063267100 / 9743261000 / CB0278 OE # = 9673170603, A9673170603	T5054 = ⊥ ⊖ T1256 = ⊖ ⊖ (21.5ID) T5403 = ⊖ ⊖ (20ID) CB0104 = ⊥ ⊖ CB0278 = ⊖ ⊗	
All	1114, 1117, 1120, 1124	T1069	—	T1069 OE# 6743230600	⊖ ⊖		"CB0080"	CB0080 OE # = 673 317 0103 673 317 0203 673 317 0303	⊖ ⊖	

Key

*	See important installation information on inside front cover
!	Excluding self-levelling suspension
"..."	Special order – phone 010 900 1850. 6-12 week waiting period

~	Imported
#	Internal bump stop
⊖	Steering damper

- It is recommended that all new shock absorbers are fitted in pairs
- Do not mix gas and non-gas units on the same axle
- **Bold** part numbers indicate heavy-duty shocks
- Underlined part numbers indicate parts not immediately available
- *Italic* part numbers followed by > indicate parts to be discontinued
- *13 Check the OE part number on the old shock for the correct application

Truck, bus and trailer

Part number [alphabetical listing]

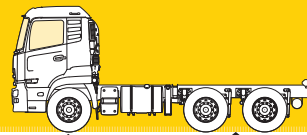

M

Year	Application	Front				Rear			
		Magnum	Cab damper	Original equipment cross-reference	Mounting information	Magnum	Cab damper	Original equipment cross-reference	Mounting information
MERCEDES-BENZ <i>continued</i>									
All	Atego 1317, 1318, 1322, 1323, 1324, 1326, 1328, 1329	T1246 OR T1220 OR T5360	CB0220	T1246 OE# = 9743230000 / 9743231300 T1220 OE# = 0033232000 0033232100 0043235600 0063235100 0063236000 0063237800 0063237900 3573230000 3753230000 A0063235100 T5360 OE# = 0053239900 0063238300 A0053239900 A0063238300 CB0220 OE# 9583170503 9583170603 9703171703 9703171803 9703174103 9703174203 A9583170503 A9583170603 A9703171703 A9703171803 A9703174103 A9703174203	T1246, T1220, T5360 (air susp) = CB0220 = (top mt ID 50mm, btm mt ID 14mm)	T1256 OR T1273 OR T5403	CB0104 *13	T1256 OE#'s: 9703260000 / 9703260200 / 9703260700 / A9703260200 T1273 OE#'s: 9703260100 A9703260100 CB0104 OE#'s: 381 890 0719 381 890 0919 387 890 1019 387 890 1319 387 890 1619 T5403 OE#'s: 0063262000 / 0063267100 / 9743261000 /	T1256 = (ID 21.5mm) T1273 = (ID 16mm) T5403 = (20ID) CB0104 =
All	1413, 1413K, 1414, 1417, 1417K, 1419, 1419K, 1419S, 1420, 1422, 1424, 1425, 1426, 1427, 1428	T1016	-	T1016 OE# = 002 323 3200 002 323 5800 002 323 5900 002 323 7200 002 323 7300 002 323 8600 002 323 8700 002 326 9500 003 323 7100 003 323 9700 003 326 0200 003 326 7700 004 323 0000 004 323 0100 004 323 4400 004 323 4500 004 323 4600 004 323 5200 004 323 6400 004 323 9700 004 323 9800 006 323 0700 006 323 0800 A004 323 4500		T5054 >	CB0104	T5054 OE# = 002 326 4600 002 326 4700 003 326 4500 003 326 9200 385 326 0100	T5054 = B0104 =

Key	
*	See important installation information on inside front cover
!	Excluding self-levelling suspension
"..."	Special order - phone 010 900 1850. 6-12 week waiting period

~	Imported
#	Internal bump stop
⊕	Steering damper

- It is recommended that all new shock absorbers are fitted in pairs
- Do not mix gas and non-gas units on the same axle
- **Bold** part numbers indicate heavy-duty shocks
- Underlined part numbers indicate parts not immediately available
- *Italic* part numbers followed by > indicate parts to be discontinued
- *13 Check the OE part number on the old shock for the correct application

Truck, bus and trailer

Part number [alphabetical listing]

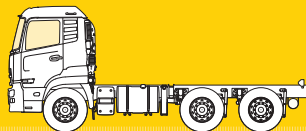

Year	Application	Front				Rear			
		Magnum	Cab damper	Original equipment cross-reference	Mounting information	Magnum	Cab damper	Original equipment cross-reference	Mounting information
MERCEDES-BENZ continued									
All	Atego 1513, 1517, 1518, 1519, 1522, 1523, 1524, 1526, 1528, 1529, 1621,	T1246 OR T1220 OR T5360	CB0220 *13	T1246 OE# = 9743230000 / 9743231300 T1220 OE# = 0033232000 0033232100 0043235600 0063235100 0063236000 0063237800 0063237900 3573230000 3753230000 A0063235100 T5360 OE# = 0053239900 0063238300 A0053239900 A0063238300 CBO220 OE# = 9583170503 9583170603 9703171703 9703171803 9703174103 9703174203 A9583170503 A9583170603 A9703171703 A9703171803 A9703174103 A9703174203	T1246, T1220, T5360 (airsusp) = CBO220 = (top mt ID 50mm, btm mt ID 14mm)	T5178 OR T1273 OR T5403	"CB0277" OR "CB0278"	T5178 OE#s: 9703260400 9743260000 9743260400 A9743260400 T1273 OE#s: 9703260100 A9703260100 T5403 OE#s: 0063262000 / 0063267100 / 9743261000 / CBO277 OE#s: 9673170203, 9408901719 CBO278 OE#s: 9673170603	T5178 (ID top 16mm, btm 20mm) T1273 (ID 16mm) T5403 (ID 20mm) CBO277 & CBO278 (incl spring)
All	1613, 1614, 1617, 1619, 1620, 1622	T1016	—	T1016 OE# = 002 323 3200 002 323 5800 002 323 5900 002 323 7200 002 323 7300 002 323 8600 002 323 8700 002 326 9500 003 323 7100 003 323 9700 003 326 0200 003 326 7700 004 323 0000 004 323 0100 004 323 4400 004 323 4500 004 323 4600 004 323 5200 004 323 6400 004 323 9700 004 323 9800 006 323 0700 006 323 0800 A004 323 4500		T5054 >	CB0104	3E818E900E919	T5054 = CB0104 =

Key

*	See important installation information on inside front cover
!	Excluding self-levelling suspension
"..."	Special order – phone 010 900 1850. 6-12 week waiting period

~	Imported
#	Internal bump stop
⊕	Steering damper

- It is recommended that all new shock absorbers are fitted in pairs
- Do not mix gas and non-gas units on the same axle
- **Bold** part numbers indicate heavy-duty shocks
- Underlined part numbers indicate parts not immediately available
- *Italic* part numbers followed by > indicate parts to be discontinued
- *13 Check the OE part number on the old shock for the correct application

Truck, bus and trailer

Part number [alphabetical listing]

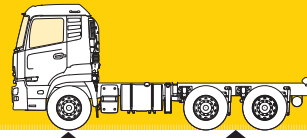

Year	Application	Front				Rear			
		Magnum	Cab damper	Original equipment cross-reference	Mounting information	Magnum	Cab damper	Original equipment cross-reference	Mounting information
MERCEDES-BENZ <i>continued</i>									
All	1624, L, LK, LAK, LS, LAS	T1016	—	T1016 OE# = 002 323 3200 002 323 5800 002 323 5900 002 323 7200 002 323 7300 002 323 8600 002 323 8700 002 326 9500 003 323 7100 003 323 9700 003 326 0200 003 326 7700 004 323 0000 004 323 0100 004 323 4400 004 323 4500 004 323 4600 004 323 5200 004 323 6400 004 323 9700 004 323 9800 006 323 0700 006 323 0800 A004 323 4500	⊖ ⊖	T5054 >	—	3E878E901E319	T5054 = ⊥ ⊖
All	1626, 1628, 1632	T1016	—	T1016 OE# = 002 323 3200 002 323 5800 002 323 5900 002 323 7200 002 323 7300 002 323 8600 002 323 8700 002 326 9500 003 323 7100 003 323 9700 003 326 0200 003 326 7700 004 323 0000 004 323 0100 004 323 4400 004 323 4500 004 323 4600 004 323 5200 004 323 6400 004 323 9700 004 323 9800 006 323 0700 006 323 0800 A004 323 4500	⊖ ⊖		CB0104 >	CB0104 = ⊥ ⊖	
All	1628, 1633, 1635, 1636, 1644	"T1011"	CB0071	T1011 OE# = 0033233200, 0033233300, 0043239200, 0053239600, 0063230900, 0063237300, A0053239600, A0063230900 CB0071 OE# 000 891 1805 000 891 1905 000 891 2205	CB0071 = ⊖ ⊖		CB0104 > OR CB0071	CB0104 OE# = 381 890 0719 381 890 0919 387 890 1019 387 890 1319 387 890 1619 CB0071 OE# 000 891 1805 000 891 1905 000 891 2205	CB0104 = ⊥ ⊗ CB0071 = ⊖ ⊖
All	1638,		CB0071	CB0071 OE# 000 891 1805 000 891 1905 000 891 2205	CB0071 = ⊖ ⊖		CB0071	CB0071 OE# 000 891 1805 000 891 1905 000 891 2205	CB0071 = ⊖ ⊖

Key

*	See important installation information on inside front cover
!	Excluding self-levelling suspension
"..."	Special order – phone 010 900 1850. 6-12 week waiting period

~	Imported
#	Internal bump stop
⊖	Steering damper

- It is recommended that all new shock absorbers are fitted in pairs
- Do not mix gas and non-gas units on the same axle
- **Bold** part numbers indicate heavy-duty shocks
- Underlined part numbers indicate parts not immediately available
- *Italic* part numbers followed by > indicate parts to be discontinued
- *13 Check the OE part number on the old shock for the correct application

Truck, bus and trailer

Part number [alphabetical listing]

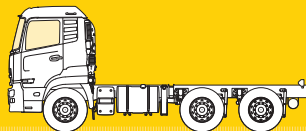

Year	Application	Front				Rear			
		Magnum	Cab damper	Original equipment cross-reference	Mounting information	Magnum	Cab damper	Original equipment cross-reference	Mounting information
MERCEDES-BENZ continued									
All	1719	T1016	—	T1016 OE# = 002 323 3200 002 323 5800 002 323 5900 002 323 7200 002 323 7300 002 323 8600 002 323 8700 002 326 9500 003 323 7100 003 323 9700 003 326 0200 003 326 7700 004 323 0000 004 323 0100 004 323 4400 004 323 4500 004 323 4600 004 323 5200 004 323 6400 004 323 9700 004 323 9800 006 323 0700 006 323 0800 A004 323 4500	⊕ ⊖		CB0104 >		CB0104 = ⊥ ⊕
All	1722, 1724, 1726,				⊕ ⊖	<i>"T5030" ></i> OR <i>T5054 ></i>		T5030 OE# = 6173260000 T5054 OE# = 002 326 4600 002 326 4700 003 326 4500 003 326 9200 385 326 0100	T5030 & T5054 = ⊥ ⊕
All	1729S, 1732, 1735S, 1735 (UNCL Powerliner & Axor)	<i>"T1011"</i>		T1011 OE# = 0033233200, 0033233300, 0043239200, 0053239600, 0063230900, 0063237300, A0053239600, A0063230900	T1011 (leaf spring) ⊕ ⊖		CB0071 OR <i>"CB0097"</i>	CB0071 OE# 000 891 1805 000 891 1905 000 891 2205 CB0097 OE# 9408903919	CB0071 & CB0097 = ⊕ ⊖
All	1729, 1735, 1738, 1748	<i>"T1011"</i>	CB0071	T1011 OE# = 0033233200, 0033233300, 0043239200, 0053239600, 0063230900, 0063237300, A0053239600, A0063230900 CB0071 OE# 000 891 1805 000 891 1905 000 891 2205	T1011 = ⊕ ⊖ CB0071 = ⊕ ⊖	<i>"T1115"</i>	CB0071	T1115 OE# = 002 326 5000 002 326 5500 003 326 7400 004 326 2300 004 326 2400 004 326 4300 972 323 0100 A972 323 0100 CB0071 OE# 000 891 1805 000 891 1905 000 891 2205	T1115 = ⊕ ⊖ CB0071 = ⊕ ⊖
All	Axor 1820, 1824	T1220 OR T5360		T1220 OE# = 0033232000 0033232100 0043235600 0063235100 0063236000 0063237800 0063237900 3573230000 3753230000 A0063235100 T5360 OE# = 0053239900 0063238300 A0053239900 A0063238300	T1220, T5360 (air susp) ⊕ ⊖	<i>T5054 ></i>	<i>"CB0097"</i>	T5054 OE# = 002 326 4600 002 326 4700 003 326 4500 003 326 9200 385 326 0100 CB0097 OE# 9408903919	T5054 = ⊥ ⊕ CB0097 = ⊕ ⊖

Key

*	See important installation information on inside front cover
!	Excluding self-levelling suspension
"..."	Special order – phone 010 900 1850. 6-12 week waiting period

~	Imported
#	Internal bump stop
⊕	Steering damper

- It is recommended that all new shock absorbers are fitted in pairs
- Do not mix gas and non-gas units on the same axle
- **Bold** part numbers indicate heavy-duty shocks
- Underlined part numbers indicate parts not immediately available
- *Italic* part numbers followed by > indicate parts to be discontinued
- *13 Check the OE part number on the old shock for the correct application

Truck, bus and trailer

Part number [alphabetical listing]

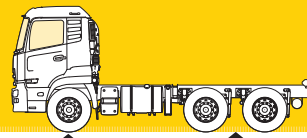

Year	Application	Front				Rear			
		Magnum	Cab damper	Original equipment cross-reference	Mounting information	Magnum	Cab damper	Original equipment cross-reference	Mounting information
MERCEDES-BENZ <i>continued</i>									
All	Atego, Actros & Axor 1823 -> 1857 Actros 1858, 1860	"T1197" OR T1207 OR T1204 OR T1246 OR T1220 OR T5360	CB0122 (coil) OR CB0127 (coil) OR CB0129 (coil) OR CB0148 (rubber) OR CB0163 OR CB0220 OR CB0100 OR "CB0292"	T1197 OE#'s = 0023231500 / 0023235300 / 0043234300 / 0043236100 / 0063233300 / 0063233900 / 006323400 / A006323300 T1207 OE# = 0053239700 / 0063231600 / 0063232100 / 0063233800 / 0063236500 / 0063237100 / 0063237200 / 3753230100 / A0053239700 T1204 OE# = 001 323 1100/ 002 323 1000/ 002 323 1100/ 002 323 1600/ 002 323 5400/ 003 323 1000/ 004 323 3600/ 004 323 4900/ 004 323 6500/ 005 323 9500/ 006 323 3700/ 006 323 6100/ A005 323 9500('98-'04) T1246 OE# = 974323000 / 9743230600 / A9743230600 / 9743231300 T1220 OE# = 0033232000 0033232100 0043235600 0063235100 0063236000 0063237800 0063237900 3573230000 3753230000 A0063235100 T5360 OE# = 0053239900 0063238300 A0053239900 A0063238300 CB0122 OE# = 942 890 5419 943 890 0319 CB0127 OE# = 942 890 2619 942 890 5119 A942 890 2619 A942 890 5119 CB0129 OE# = 942 890 5019 A942 890 5019 CB0148 OE# = 942 890 0519 958 317 0703 A942 890 0519 A958 317 0703 CB0220 OE# 9583170503 9583170603 9703171703 9703171803 9703174103 9703174203 A9583170503 A9583170603 A9703171703 A9703171803 A9703174103 A9703174203 CB0100 OE# 942 890 2219 942 890 2819 A942 890 2819	T1197, T1207, T1204, T1246, T1220, T6360 (air susp) CB0122 & CB0127 & CB0129 (coil susp) CB0148 (rubber) CB0220 (top mt ID 50mm, btm mt ID 14mm), CB0100 (coil -top mt ID 14mm, btm mt ID 25mm). "CB0026" (top mt ID 14mm, btm mt ID 14mm) All =	T1201 OR T5171 OR "T1200" OR T1210 OR T5372 OR T5137 OR T5256 OR T1273 OR T5358	CB0101 OR "CB0097" OR CB0090 OR CB0150 OR CB0156 OR CB0096 OR "CB0144" OR "CB0263"	T1201 OE#'s = 0053260900 / 0053265700 / 0053265800 / 0053265900 / 0053266300 / A0053260900 T5171 OE#'s = 0053267400 / 0063260100 / A0053267400 T1200 OE# = 005 326 3300 005 326 3400 A005 326 3300 T1210 OE# = 005 326 1000 A005 326 1000 T1211 OE# = 005 326 6000 005 326 6400 A005 326 6000 T5137 OE# 0053261200 0063265600 A0053261200 T5256 0053261400 0063260500 A0053261400 T1273 OE#'s: 9703260100 A9703260100 T5358 OE#'s: 0063261200, 0053268800, 0063260300, 0053267400, 0063260100, 0063261100, 0063262200 CB0101 OE# 9428902319 / 9428903119/ 9438900819 CB0097 OE# 9408903919 CB0090 OE# 942 890 0219 942 890 6019 943 890 3919 A942 890 0219 CB0150 OE# 375 890 0419 375 890 0919 940 890 3819 940 890 4719 958 317 1003 958 317 1103 A375 890 0419 A375 890 0919 A940 890 3819 A940 890 4719 A958 317 1003 A958 317 1103 CB0156 OE# 943 890 3119 943 890 3219 A943 890 3219 CB0096 OE# 942 890 4719 A942 890 4719 CB0144 OE# 942 890 3919 943 890 1319 A942 890 3919 A943 890 1319 CB0263 OE#: 9408900819, 9408900919, 9408901319, 9583170403	ALL = ⊗ T1201 ID = 16 T5171 ID = 20 T1200 ID = 16 T1210 ID = 16 T5372 ID = 16 T5137 ID = 20 T5256 ID = 20 T1273 ID = 16 T5358 ID = 20 CB0101 & CB0150 & CB0156 (All with spring) ⊗ ID = 14 CB0097 ⊗ ID = 12 CB0090 (air susp) ⊗ ID = 14 CB0096 ⊗ (shock only) ID = 12mm CB0144 ⊗ (incl spring) top ID = 14mm CB0263 ⊗ (incl spring)

Key	
*	See important installation information on inside front cover
!	Excluding self-levelling suspension
"..."	Special order - phone 010 900 1850. 6-12 week waiting period

~	Imported
#	Internal bump stop
⊕	Steering damper

- It is recommended that all new shock absorbers are fitted in pairs
- Do not mix gas and non-gas units on the same axle
- **Bold** part numbers indicate heavy-duty shocks
- Underlined part numbers indicate parts not immediately available
- *Italic* part numbers followed by > indicate parts to be discontinued
- *13 Check the OE part number on the old shock for the correct application

Truck, bus and trailer

Part number [alphabetical listing]

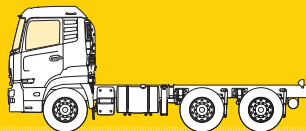

Year	Application	Front				Rear			
		Magnum	Cab damper	Original equipment cross-reference	Mounting information	Magnum	Cab damper	Original equipment cross-reference	Mounting information
MERCEDES-BENZ continued									
All	1838	T1016 OR "T1011"	CB0071	T1016 OE#s= 002 323 3200 002 323 5800 002 323 5900 002 323 7200 002 323 7300 002 323 8600 002 323 8700 002 326 9500 003 323 7100 003 323 9700 003 326 0200 003 326 7700 004 323 0000 004 323 0100 004 323 4400 004 323 4500 004 323 4600 004 323 5200 004 323 6400 004 323 9700 004 323 9800 006 323 0700 006 323 0800 A004 323 4500T1011 OE#s= 0033233200 / 0033233300 / 0043239200 / 0053239600 / 0063230900 / 0063237300 / A0053239600 / A0063230900 CB0071 OE# 000 891 1805 000 891 1905 000 891 2205	T1016 = ⊕ ⊖ CB0071 = ⊕ ⊖	CB0101 OR CB0071	CB0101 OE# 9428902319, 9428903119, 9438900819, 9438900919 CB0071 OE# 000 891 1805 000 891 1905 000 891 2205	CB007 = ⊕ ⊖	
All	1844, 1850		CB0071	CB0071 OE# 000 891 1805 000 891 1905 000 891 2205	⊕ ⊖	<u>T5358</u>	CB0071	T5358 OE#s: 0063261200, 0053268800, 0063260300, 0053267400, 0063260100, 0063261100, 0063262200 CB0071 OE# 000 891 1805 000 891 1905 000 891 2205	T5358, CB0071 = ⊕ ⊖
All	1853, 1857		—			<u>T5171</u>	CB0101	000 891 2205	⊕ ⊖
All	1919	T1016	—	T1016 OE#-002 323 3200 002 323 5800 002 323 5900 002 323 7200 002 323 7300 002 323 8600 002 323 8700 002 326 9500 003 323 7100 003 323 9700 003 326 0200 003 326 7700 004 323 0000 004 323 0100 004 323 4400 004 323 4500 004 323 4600 004 323 5200 004 323 6400 004 323 9700 004 323 9800 006 323 0700 006 323 0800 A004 323 4500	⊕ ⊖	<i>CB0104</i> >		CB0104 = ⊥ ⊕	

Key

*	See important installation information on inside front cover
!	Excluding self-levelling suspension
"..."	Special order – phone 010 900 1850. 6-12 week waiting period

~	Imported
#	Internal bump stop
⊕	Steering damper

- It is recommended that all new shock absorbers are fitted in pairs
- Do not mix gas and non-gas units on the same axle
- **Bold** part numbers indicate heavy-duty shocks
- Underlined part numbers indicate parts not immediately available
- *Italic* part numbers followed by > indicate parts to be discontinued
- *13 Check the OE part number on the old shock for the correct application

Truck, bus and trailer

Part number [alphabetical listing]

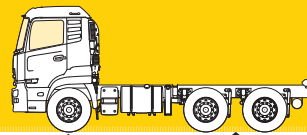

Year	Application	Front				Rear			
		Magnum	Cab damper	Original equipment cross-reference	Mounting information	Magnum	Cab damper	Original equipment cross-reference	Mounting information
MERCEDES-BENZ <i>continued</i>									
All	1922	"T1011" *13	—	T1011 OE# = 0033233200, 0033233300, 0043239200, 0053239600, 0063230900, 0063237300, A0053239600, A0063230900	⊖ ⊖		CB0104 >		CB0104 = ⊥ ⊖
All	Atego 1923,1924	T1220 or T5360	CB0220	T1220 OE# = 0033232000 0033232100 0043235600 0063235100 0063236000 0063237800 0063237900 3573230000 3753230000 A0063235100 T5360 OE# = 0053239900 0063238300 A0053239900 A0063238300 CB0220 OE# 9583170503 9583170603 9703171703 9703171803 9703174103 9703174203 A9583170503 A9583170603 A9703171703 A9703171803 A9703174103 A9703174203	T1220, T5360 (air susp) = ⊖ ⊖ CB0220 = ⊖ ⊖ (top mt ID 50mm, btm mt ID 14mm) Alt = ⊖ ⊖	T1273 or T5403	—	T1273 OE#s: 9703260100 A9703260100 T5403 OE#s: 0063262000 / 0063267100 / 9743261000 /	T1273 ⊖ ⊖ (ID 16mm) T5403 ⊖ ⊖ (ID 20mm)
All	Atego 1926, 1928	T1016 or "T1011"		T1016 OE# = 002 323 3200 002 323 5800 002 323 5900 002 323 7200 002 323 7300 002 323 8600 002 323 8700 002 326 9500 003 323 7100 003 323 9700 003 326 0200 003 326 7700 004 323 0000 004 323 0100 004 323 4400 004 323 4500 004 323 4600 004 323 5200 004 323 6400 004 323 9700 004 323 9800 006 323 0700 006 323 0800 A004 323 4500 T1011 OE# = 0033233200, 0033233300, 0043239200, 0053239600, 0063230900, 0063237300, A0053239600, A0063230900	Alt = ⊖ ⊖	T5403	CB0104 >	T5403 OE#s: 0063262000 / 0063267100 / 9743261000 /	T5403 ⊖ ⊖ (ID 20mm) CB0104 = ⊥ ⊖

*	See important installation information on inside front cover
!	Excluding self-levelling suspension
"..."	Special order – phone 010 900 1850. 6-12 week waiting period

~	Imported
#	Internal bump stop
⊖	Steering damper

- It is recommended that all new shock absorbers are fitted in pairs
- Do not mix gas and non-gas units on the same axle
- **Bold** part numbers indicate heavy-duty shocks
- Underlined part numbers indicate parts not immediately available
- *Italic* part numbers followed by > indicate parts to be discontinued
- *13 Check the OE part number on the old shock for the correct application

Truck, bus and trailer

Part number [alphabetical listing]

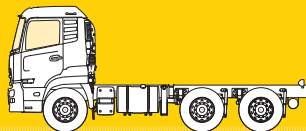

Year	Application	Front				Rear			
		Magnum	Cab damper	Original equipment cross-reference	Mounting information	Magnum	Cab damper	Original equipment cross-reference	Mounting information
MERCEDES-BENZ continued									
All	Atego 1929, 1932, 1933, 1935, 1936, 1938, 1948	"T1011" OR T1016	CB0071	T1011 OE# = 0033233200, 0033233300, 0043239200, 0053239600, 0063230900, 0063237300, A0053239600, A0063230900 T1016 OE# = 002 323 5800 002 323 5900 002 323 7200 002 323 7300 002 323 8600 002 323 8700 002 326 9500 003 323 7100 003 323 9700 003 326 0200 003 326 7700 004 323 0000 004 323 0100 004 323 4400 004 323 4500 004 323 4600 004 323 5200 004 323 6400 004 323 9700 004 323 9800 006 323 0700 006 323 0800 A004 323 4500 CB0071 OE# 000 891 1805 000 891 1905 000 891 2205	⊖ ⊖	"T1115" OR T5403	CB0071	T1115 OE# = 002 326 5000 002 326 5500 003 326 7400 004 326 2300 004 326 2400 004 326 4300 972 323 0100 A972 323 0100 T5403 OE#s: 0063262000 / 0063267100 / 9743261000 / CB0071 OE# 000 891 1805 000 891 1905 000 891 2205	⊖ ⊖ T1115 = ⊖ ⊖ T5403 ⊖ ⊖ (ID 20mm) CB0071 = ⊖ ⊖
All	2017, 2019, 2024, 2029, 2632, 2628, L, LB	—	—		⊖ ⊖	—	"CB0097"	CB0097 OE# 9408903919	CB0097= ⊖ ⊖
All	2031, 2035, 2038, 2044, 2055	"T1011"	—	T1011 OE# = 0033233200, 0033233300, 0043239200, 0053239600, 0063230900, 0063237300, A0053239600, A0063230900	⊖ ⊖	"T1200" OR T1210 OR T5372	"CB0097"	T1200 OE# = 005 326 3300 005 326 3400 A005 326 3300 T1210 OE# = 005 326 1000 A005 326 1000 T5372 OE# = 005 326 6000 005 326 6400 A005 326 6000 CB0097 OE# 9408903919	⊖ ⊖ Bushing ID all J...#s = 16mm Open lengths T1200=856mm / T1210 = 766mm / T5372 = 896mm

Key

*	See important installation information on inside front cover
!	Excluding self-levelling suspension
"..."	Special order – phone 010 900 1850. 6-12 week waiting period

~	Imported
#	Internal bump stop
⊖	Steering damper

- It is recommended that all new shock absorbers are fitted in pairs
- Do not mix gas and non-gas units on the same axle
- **Bold** part numbers indicate heavy-duty shocks
- Underlined part numbers indicate parts not immediately available
- *Italic* part numbers followed by > indicate parts to be discontinued
- *13 Check the OE part number on the old shock for the correct application

Truck, bus and trailer

Part number [alphabetical listing]

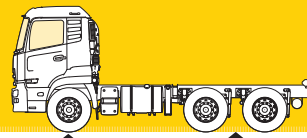

Year	Application	Front				Rear			
		Magnum	Cab damper	Original equipment cross-reference	Mounting information	Magnum	Cab damper	Original equipment cross-reference	Mounting information
MERCEDES-BENZ <i>continued</i>									
All	Actros 2031, 2040, 2053, 2531, 2535, 2540, 2543, 2548, 2631, 2635, 2640, 2643, 2648, 2653, 2657	"T1197" OR T1207 OR T1220 OR T5360 *13	CB0122 (coil) OR CB0129 (coil) OR CB0148 OR CB0100 OR "CB00276"	T1197 OE# = 0023231500 / 0023235300 / 0043234300 / 0043236100 / 0063233300 / 0063233300 / 0063233300 / 0063234000 / 0063237400 / A0063233300 T1207 OE# = 0053239700 / 0063231600 / 0063232100 / 0063233800 / 0063236500 / 0063237100 / 0063237200 / 3753230100 / A0053239700 T1220 OE# = 0033232000 0033232100 0043235600 0063235100 0063236000 0063237800 0063237900 3573230000 3753230000 A0063235100 T5360 OE# = 0053239900 0063238300 A0053239900 A0063238300 CB0122 OE# = 942 890 5419 943 890 0319 CB0129 OE# = 942 890 5019 A942 890 5019 CB0148 OE# = 942 890 0519 958 317 0703 A942 890 0519 A958 317 0703 CB0100 OE# = 942 890 2219 942 890 2819 A942 890 2819	⊖ ⊖	T1201 OR T1210 OR T5372 OR T5137 OR T5256	"CB0097" OR CB0090 OR CB0155 OR CB0156 OR CB0158 OR CB0096 OR "CB0263"	T1201 OE#'s = 0053260900 / 0053265700 / 0053265800 / 0053265900 / 0053266300 / A0053260900 T1210 OE# = 005 326 1000 A005 326 1000 T5372 OE# = 005 326 6000 005 326 6400 A005 326 6000 T5137 OE# 0053261200 0063265600 A0053261200 T5656 OE# 0053261400 0063260500 A0053261400 CB0097 OE# 9408903919 CB0090 OE# 942 890 0219 942 890 6019 943 890 3919 A942 890 0219 CB0155 OE# 943 890 3419 943 890 3519 A943 890 3419 A943 890 3519 CB0156 OE# 943 890 3119 943 890 3219 A943 890 3119 A943 890 3219 CB0096 OE# 942 890 4719 A942 890 4719	All ⊖ ⊖ T1210, T5372 ID = 16mm Open Lengths T1201 = 856mm / T1210 = 766mm / T5372 = 896mm T5137 & T5256 ID = 20mm CB0097 ID = 12mm CB0090 (air susp) ID = 14mm CB0155 & CB0156 (spring) ID = 14mm CB0096 (shock only) ID = 12mm
All	Actros 2032, 2036, 2041, 2044, 2046, 2050, 2051	T1220 OR T5360	CB0148 OR CB0100	T1220 OE# = 0033232000 0033232100 0043235600 0063235100 0063236000 0063237800 0063237900 3573230000 3753230000 A0063235100 T5360 OE# = 0053239900 0063238300 A0053239900 A0063238300 CB0148 OE# = 942 890 0519 958 317 0703 A942 890 0519 A958 317 0703 CB0100 OE# = 942 890 2219 942 890 2819 A942 890 2819	⊖ ⊖	T5137 OR T5256	"CB0097" OR CB0155 OR CB0156 OR CB0096	T5137 OE# 0053261200 0063265600 A0053261200 T5256 OE# 0053261400 0063260500 A0053261400 CB0097 OE# 9408903919 CB0155 OE# 943 890 3419 943 890 3519 A943 890 3419 A943 890 3519 CB0156 OE# 943 890 3119 943 890 3219 A943 890 3119 A943 890 3219 CB0096 OE# 942 890 4719 A942 890 4719	T5137 & T5256 ID 20mm CB0097, CB0096 ID 12mm (shock only) CB0155 & CB0156 (incl spring) = ID 14mm
All	2220, L, LA, LS, LAS	-	-	-	⊖ ⊖	-	CB0104	⊥ ⊖	

Key

*	See important installation information on inside front cover
!	Excluding self-levelling suspension
"..."	Special order - phone 010 900 1850. 6-12 week waiting period

~	Imported
#	Internal bump stop
⊖	Steering damper

- It is recommended that all new shock absorbers are fitted in pairs
- Do not mix gas and non-gas units on the same axle
- **Bold** part numbers indicate heavy-duty shocks
- Underlined part numbers indicate parts not immediately available
- *Italic* part numbers followed by > indicate parts to be discontinued
- *13 Check the OE part number on the old shock for the correct application

Truck, bus and trailer

Part number [alphabetical listing]

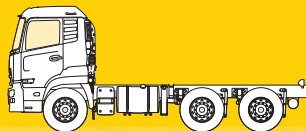

Year	Application	Front				Rear			
		Magnum	Cab damper	Original equipment cross-reference	Mounting information	Magnum	Cab damper	Original equipment cross-reference	Mounting information
MERCEDES-BENZ continued									
All	2219, 2222		—		⊖ ⊖	T5054 > *13	—	T5054 OE# = 002 326 4600 002 326 4700 003 326 4500 003 326 9200 385 326 0100	T5054 = ⊥ ⊖
All	2223, 2226, 2228, 2232, 2233, 2235, 2236, 2238 (with Atego)	T1220 OR T5360	CB0220	T1220 OE# = 0033232000 0033232100 0043235600 0063235100 0063236000 0063237800 0063237900 3573230000 3753230000 A0063235100 T5360 OE# = 0053239900 0063238300 A0053239900 A0063238300 CB0220 OE# 9583170503 9583170603 9703171703 9703171803 9703174103 9703174203 A9583170503 A9583170603 A9703171703 A9703171803 A9703174103 A9703174203	T1220, T5360 = ⊖ ⊖ CB0220 = ⊖ ⊖ (top mt ID 50mm, btm mt ID 14mm) All = ⊖ ⊖	T1273 OR	—	T1273 OE#s: 9703260100 A9703260100	T1273 ⊖ ⊖ (ID 16mm)

Key

*	See important installation information on inside front cover
!	Excluding self-levelling suspension
"..."	Special order – phone 010 900 1850. 6-12 week waiting period

~	Imported
#	Internal bump stop
⊖	Steering damper

- It is recommended that all new shock absorbers are fitted in pairs
- Do not mix gas and non-gas units on the same axle
- **Bold** part numbers indicate heavy-duty shocks
- Underlined part numbers indicate parts not immediately available
- *Italic* part numbers followed by > indicate parts to be discontinued
- *13 Check the OE part number on the old shock for the correct application

Truck, bus and trailer

Part number [alphabetical listing]

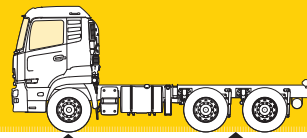

Year	Application	Front				Rear			
		Magnum	Cab damper	Original equipment cross-reference	Mounting information	Magnum	Cab damper	Original equipment cross-reference	Mounting information
MERCEDES-BENZ <i>continued</i>									
ALL	Actros, Atego, Axor : 2223, 2224, 2225, 2226, 2228, 2229, 2232, 2233, 2235, 2236, 2238, 2244, 2426, 2428, 2429, 2432, 2435, 2436, 2438, 2448, 2531, 2534, 2535, 2538, 2540, 2543, 2544, 2548, 2550, 2553, 2623, 2626, 2628, 2629, 2632, 2633, 2635, 2636, 2638 (MCI Powertiner)		CB0071 OR CB0127 OR CB0129 OR CB0148 OR CB0163 OR CB0220 OR CB0100	T1011 OE# = 0033233200, 0033233300, 0043239200, 0053239600, 0063230900, 0063237300, A0053239600, A0063230900 T1016 OE# = 002 323 5800 002 323 5900 002 323 7200 002 323 7300 002 323 8600 002 323 8700 002 326 9500 003 323 7100 003 323 9700 003 326 0200 003 326 7700 004 323 0000 004 323 0100 004 323 4400 004 323 4500 004 323 4600 004 323 5200 004 323 6400 004 323 9700 004 323 9800 006 323 0700 006 323 0800 A004 323 4500 T1220 OE#= 0033232000 0033232100 0043235600 0063235100 0063236000 0063237800 0063237900 3573230000 3753230000 A0063235100 T5360 OE#= 0053239900 0063238300 A0053239900 A0063238300 ----- CB0071 OE# 000 891 1805 000 891 1905 000 891 2205 CB0127 OE# = 942 890 2619 942 890 5119 A942 890 2619 A942 890 5119 CB0129 OE# = 942 890 5019 A942 890 5019 CB0148 OE# = 942 890 0519 9408900519 CB0220 OE# 9583170503 9583170603 9703171703 9703171803 9703174103 9703174203 A9583170503 A9583170603 A9703171703 A9703171803 A9703174103 A9703174203 CB0100 OE# = 942 890 2219 942 890 2819 A942 890 2819	T1011, T1016, T1220, T5360 (air susp) ----- CB0071 CB0127 CB0129 (coil) CB0148 CB0100 (coil) ----- CB0220 = ----- (top mt ID 50mm, btm mt ID 14mm) All = ⊕ ⊖	T5054 > OR "T1200" OR "T1115" OR T5137 OR T5256 OR T1273 OR T5403 OR T5358	CB0104 OR CB0071 OR CB0150 OR CB0156 OR CB0164 OR CB0096 OR "CB0263"	T5054 OE# = 002 326 4600 002 326 4700 003 326 4500 003 326 9200 385 326 0100 T1200 OE# = 005 326 3300 005 326 3400 A005 326 3300 T1115 OE# = 002 326 5000 002 326 5500 003 326 7400 004 326 2300 004 326 2400 004 326 4300 972 323 0100 A972 323 0100 T5033 OE# = 001 326 9300 393 326 0000 T5137 OE# 0053261200 0063265600 A0053261200 T5656 OE# 0053261400 0063260500 A0053261400 T1273 OE#s: 9703260100 A9703260100 T5403 OE#s: 0063262000 / 0063267100 / 9743261000 T5358 OE#s: 0063261200, 0053268800, 0063260300, 0053267400, 0063260100, 0063261100, 0063262200 ----- CB0071 OE# 000 891 1805 000 891 1905 000 891 2205 CB0150 OE# : 375 890 0419 375 890 0919 940 890 3819 940 890 4719 958 317 1003 958 317 1103 A375 890 0419 A375 890 0919 A940 890 3819 A940 890 4719 A958 317 1003 A958 317 1103 CB0150 OE# : 943 890 3119 943 890 3219 A943 890 3219 CB0096 OE# 942 890 4719 A942 890 4719 CB0144 OE# 942 890 3919 943 890 1319 A942 890 3919 A943 890 1319	T5054 = ⊕ ⊖ T1200, T1115, T5137, T5256, T1273 = ⊕ ⊖ T5033 = ⊕ ⊖ T5403 & T5358 ⊕ ⊖ (ID 20mm) CB0104 = ⊕ ⊖ B0071 & CB0150 & CB0156 (with spring) ID - 14mm = ⊕ ⊖ CB0096 (shock only) ID = 12mm CB0144 ⊕ ⊗ (incl spring) top ID = 14mm

Key	
*	See important installation information on inside front cover
!	Excluding self-levelling suspension
"..."	Special order - phone 010 900 1850. 6-12 week waiting period

~	Imported
#	Internal bump stop
⊕	Steering damper

- It is recommended that all new shock absorbers are fitted in pairs
- Do not mix gas and non-gas units on the same axle
- **Bold** part numbers indicate heavy-duty shocks
- Underlined part numbers indicate parts not immediately available
- *Italic* part numbers followed by > indicate parts to be discontinued
- *13 Check the OE part number on the old shock for the correct application

Truck, bus and trailer

Part number [alphabetical listing]

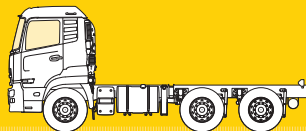

Year	Application	Front				Rear			
		Magnum	Cab damper	Original equipment cross-reference	Mounting information	Magnum	Cab damper	Original equipment cross-reference	Mounting information
MERCEDES-BENZ continued									
All	Actros, Atego, Axor: 2523, 2528, 2532, 2536, 2541, 2544, 2546, 2548, 2551, 2555, 2560	T1220 OR T5360	CB0148 OR CB0163 OR CB0220 OR CB0100 OR "CB0292"	T1220 OE# = 0033232000 0033232100 0043235600 0063235100 0063236000 0063237800 0063237900 3573230000 3753230000 A0063235100 T5360 OE# = 0053239900 0063238300 A0053239900 A0063238300 CB0148 OE# = 942 890 0519 958 317 0703 A942 890 0519 A958 317 0703 CB0220 OE# 9583170503 9583170603 9703171703 9703171803 9703174103 9703174203 A9583170503 A9583170603 A9703171703 A9703171803 A9703174103 A9703174203 CB0100 OE# = 942 890 2219 942 890 2819 A942 890 2819	T1220, T5360 (air susp) ⊗ ⊗ CB0148 ⊗ ⊗ ID 12mm CB0220 = ⊗ ⊗ (top mt ID 50mm, btm mt ID 14mm) CB0100 = ⊗ ⊗ (top mt ID 14mm, btm mt ID 25mm) CB0292 = ⊗ ⊗ (top mt ID 35mm, btm mt ID 14mm) MC spring	T5137 OR T5256 OR T1273 OR T5358	"CB0097" OR CB0150 OR CB0155 OR CB0156 OR CB0218 OR CB0096 OR "CB0263"	T5137 OE# 0053261200 0063265600 A0053261200 T5256 OE# 0053261400 0063260500 A0053261400 T1273 OE#s: 9703260100 A9703260100 T5358 OE#s: 0063261200, 0053268800, 0063260300, 0053267400, 0063260100, 0063261100, 0063262200 CB0097 OE# 9408903919 CB0150 OE# : 375 890 0419 375 890 0919 940 890 3819 940 890 4719 958 317 1003 958 317 1103 A375 890 0419 A375 890 0919 A940 890 3819 A940 890 4719 A958 317 1003 A958 317 1103 CB0155 OE# 943 890 3419 943 890 3519 A943 890 3419 A943 890 3519 CB0156 OE# 943 890 3119 943 890 3219 A943 890 3119 A943 890 3219 CB0096 OE# 942 890 4719 A942 890 4719 CB0263 OE# 9408900819, 9408900919, 9408901319, 9408901519, 9583170403,	T5137 & T5256 ⊗ ⊗ (ID = 20mm) T1273 ⊗ ⊗ (ID 16mm) CB0097, CB0096 (shock only) = ⊗ ⊗ ID = 12mm CB0150 & CB0155 & CB0156 (incl spring) ⊗ ⊗ ID = 14mm CB0263 (incl spring) ⊗ ⊗ ID = 14mm
All	Axor, Atego : 2523, 2528, 2529, 2533	T1220 OR T5360	CB0220	T1220 OE# = 0033232000 0033232100 0043235600 0063235100 0063236000 0063237800 0063237900 3573230000 3753230000 A0063235100 T5360 OE# =0053239900 0063238300 A0053239900 A0063238300 CB0220 OE# 9583170503 9583170603 9703171703 9703171803 9703174103 9703174203 A9583170503 A9583170603 A9703171703 A9703171803 A9703174103 A9703174203	T1220, T5360 (air susp) ⊗ ⊗ CB0220 = ⊗ ⊗ (top mt ID 50mm, btm mt ID 14mm) All = ⊗ ⊗	T5256 OR T1273	CB0150 OR "CB0263"	T5256 OE# 0053261400 0063260500 A0053261400 T1273 OE#s: 9703260100 A9703260100 CB0150 OE# : 375 890 0419 375 890 0919 940 890 3819 940 890 4719 958 317 1003 958 317 1103 A375 890 0419 A375 890 0919 A940 890 3819 A940 890 4719 A958 317 1003 A958 317 1103 CB0263 OE# 9408900819, 9408900919, 9408901319, 9408901519, 9583170403,	T5256 ⊗ ⊗ (ID 20mm) T1273 ⊗ ⊗ (ID 16mm) CB0150 (spring) ⊗ ⊗ (ID = 14mm) CB0263 (incl spring) ⊗ ⊗ ID = 14mm

Key

*	See important installation information on inside front cover
!	Excluding self-levelling suspension
"..."	Special order - phone 010 900 1850. 6-12 week waiting period

~	Imported
#	Internal bump stop
⊗	Steering damper

- It is recommended that all new shock absorbers are fitted in pairs
- Do not mix gas and non-gas units on the same axle
- **Bold** part numbers indicate heavy-duty shocks
- Underlined part numbers indicate parts not immediately available
- *Italic* part numbers followed by > indicate parts to be discontinued
- *13 Check the OE part number on the old shock for the correct application

Truck, bus and trailer

Part number [alphabetical listing]

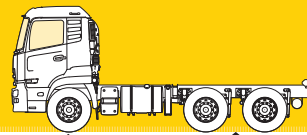

Year	Application	Front				Rear			
		Magnum	Cab damper	Original equipment cross-reference	Mounting information	Magnum	Cab damper	Original equipment cross-reference	Mounting information
MERCEDES-BENZ <i>continued</i>									
All	Actros, Atego, Axor 2628, 2629, 2632, 2633, 2636, 2641, 2644, 2646, 2650, 2651, 2654, 2655, 2658, 2932	T1220 OR T5360	CB0127 OR CB0129 OR CB0148 OR CB0220 OR CB0100	T1220 OE# = 0033232000 0033232100 0043235600 0063235100 0063236000 0063237800 0063237900 3573230000 3753230000 A0063235100 T5360 OE# = 0053239900 0063238300 A0053239900 A0063238300 CB0127 OE# = 942 890 2619 942 890 5119 A942 890 2619 A942 890 5119 CB0129 OE# = 942 890 5019 A942 890 5019 CB0148 OE# = 942 890 0519 958 317 0703 A942 890 0519 A958 317 0703 CB0220 OE# 9583170503 9583170603 9703171703 9703171803 9703174103 9703174203 A9583170503 A9583170603 A9703171703 A9703171803 A9703174103 A9703174203 CB0100 OE# = 942 890 2219 942 890 2819 A942 890 2819	T1220, T5360 (air susp) CB0127 & CB0129 (coil susp) CB0148 CB0220 = (top mt ID 50mm, btm mt ID 14mm) All = CB0100 = (top mt ID 14mm, btm mt ID 25mm) All =	T5363 OR T5137 OR T5256 OR T1273	"CB0097" OR CB0150 OR CB0155 OR CB0156 OR CB0164 & CB0218 OR CB0096 OR "CB0263"	T5363 OE# = 0053266800 0063262900 A0053266800 T5137 OE# 0053261200 0063265600 A0053261200 T5256 OE# 0053261400 0063260500 A0053261400 T1273 OE#s: 9703260100 A9703260100 CB0097 OE# 9408903919 CB0150 OE# : 375 890 0419 375 890 0919 940 890 3819 940 890 4719 958 317 1003 958 317 1103 A375 890 0419 A375 890 0919 A940 890 3819 A940 890 4719 A958 317 1003 A958 317 1103 CB0155 OE# 943 890 3419 943 890 3519 A943 890 3419 A943 890 3519 CB0156 OE# 943 890 3119 943 890 3219 A943 890 3119 A943 890 3219 CB0096 OE# 942 890 4719 A942 890 4719 CB0263 OE# 9408900819, 9408900919, 9408901319, 9408901519, 9583170403,	T5363, T5137, T5256 = ID = 20mm T1273 ID = 16mm CB0150, CB0155 & CB0156 (incl spring) ID = 14mm CB0097, CB0096 (shock only) ID = 12mm CB0263 (incl spring) ID = 14mm
All	2640, 2643, 2644, 2648, 2653	T1016	-	T1016 OE# = 002 323 3200 002 323 5800 002 323 5900 002 323 7200 002 323 7300 002 323 8600 002 323 8700 002 326 9500 003 323 7100 003 323 9700 003 326 0200 003 326 7700 004 323 0000 004 323 0100 004 323 4400 004 323 4500 004 323 4600 004 323 9700 004 323 9800 006 323 0700 006 323 0800 A004 323 4500		"T1200" OR T5358	"CB0097"	T1200 OE# = 005 326 3300 005 326 3400 A005 326 3300 T5358 OE#s: 0063261200, 0053268800, 0063260300, 0053267400, 0063260100, 0063261100, 0063262200 CB0097 OE# 9408903919	

Key	
*	See important installation information on inside front cover
!	Excluding self-levelling suspension
...	Special order - phone 010 900 1850. 6-12 week waiting period

~	Imported
#	Internal bump stop
⊕	Steering damper

- It is recommended that all new shock absorbers are fitted in pairs
- Do not mix gas and non-gas units on the same axle
- **Bold** part numbers indicate heavy-duty shocks
- Underlined part numbers indicate parts not immediately available
- *Italic* part numbers followed by > indicate parts to be discontinued
- *13 Check the OE part number on the old shock for the correct application

Truck, bus and trailer

Part number [alphabetical listing]

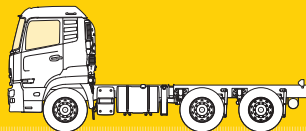

Year	Application	Front				Rear			
		Magnum	Cab damper	Original equipment cross-reference	Mounting information	Magnum	Cab damper	Original equipment cross-reference	Mounting information
MERCEDES-BENZ continued									
All	3028, 3033, 3035, 3036, 3228, Axor 3228C, 3235, 3238, 3244, 3335, 3534, 3535	"T1011" OR T1220 OR T5360	—	T1011 OE# = 0033233200, 0033233300, 0043238200, 0053239600, 0063230900, 0063237300, A0053239600, A0063230900 T1220 OE# = 0033232000, 0033232100, 0043235600, 0063235100, 0063236000, 0063237800, 0063237900, 3573230000, 3753230000, A0063235100 T5360 OE# = 0053239900, 0063238300, A0053239900, A0063238300	⊕ ⊖	T5256	CB0104 OR "CB0097" OR CB0150	T5031 OE# = 002 326 9200, 002 326 9300, 003 326 5000 T5033 OE# = 001 326 9300, 393 326 0000 T5256 OE# = 0053261400, 0063260500, A0053261400 CB0097 OE# = 9408903919 CB0150 OE# : 375 890 0419, 375 890 0919, 940 890 3819, 940 890 4719, 958 317 1003, 958 317 1103, A375 890 0419, A375 890 0919, A940 890 3819, A940 890 4719, A958 317 1003, A958 317 1103	T5031, T5256 = ⊕ ⊖ T5033 = ⊥ ⊤ CB0104 (spring) = ⊥ ⊗ CB0097 = ⊕ ⊖ ID = 12.1mm CB0150 (spring) ⊕ ⊖ ID = 14mm
All	Actros 3231, 3232, 3241, 3246, 3248, 3332, 3336, 3341, 3344, 3346, 3350, 3351, 3354, 3355, 3357, 3360	T1220 OR T5360	CB0122 OR CB0129 OR CB0148 OR CB0100	T1220 OE# = 0033232000, 0033232100, 0043235600, 0063235100, 0063236000, 0063237800, 0063237900, 3573230000, 3753230000, A0063235100 T5360 OE# = 0053239900, 0063238300, A0053239900, A0063238300 CB0122 OE# = 942 890 5419, 943 890 0319 CB0129 OE# = 942 890 5019, A942 890 5019 CB0148 OE# = 942 890 0519, 958 317 0703, A942 890 0519, A958 317 0703 CB0100 OE# = 942 890 2219, 942 890 2819, A942 890 2819	T1220, T5360, (air susp), CB0122, CB0129 (incl coil susp), CB0148, CB0100 (incl coil), All = ⊕ ⊖	T5137 OR T5256	"CB0097" OR CB0090 OR CB0156 OR CB0096	T5137 OE# 0053261200, 0063265600, A0053261200 T5256 OE# 0053261400, 0063260500, A0053261400 CB0097 OE# = 9408903919 CB0090 OE# = 942 890 0219, 942 890 6019, 943 890 3919, A942 890 0219 CB0156 OE# 943 890 3119, 943 890 3219, A943 890 3119, A943 890 3219 CB0096 OE# 942 890 4719, A942 890 4719	T5153, T5256 ⊕ ⊖ ID = 20mm CB0097, CB0096 (shock only) ⊕ ⊖ ID = 12mm CB0090 (air susp) ⊕ ⊖ ID = 14mm CB0156 (spring) ID = 14mm
68-88	LK/LN2 3240, 3243, 3335, 3340, 3343					CB0150	CB0150 OE# : 375 890 0419, 375 890 0919, 940 890 3819, 940 890 4719, 958 317 1003, 958 317 1103, A375 890 0419, A375 890 0919, A940 890 3819, A940 890 4719, A958 317 1003, A958 317 1103	CB0150 (spring) ⊕ ⊖ ID = 14mm	

Key

*	See important installation information on inside front cover
!	Excluding self-levelling suspension
...	Special order – phone 010 900 1850. 6-12 week waiting period

~	Imported
#	Internal bump stop
⊕	Steering damper

- It is recommended that all new shock absorbers are fitted in pairs
- Do not mix gas and non-gas units on the same axle
- **Bold** part numbers indicate heavy-duty shocks
- Underlined part numbers indicate parts not immediately available
- *Italic* part numbers followed by > indicate parts to be discontinued
- *13 Check the OE part number on the old shock for the correct application

Truck, bus and trailer

Part number [alphabetical listing]

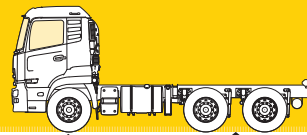

Year	Application	Front				Rear			
		Magnum	Cab damper	Original equipment cross-reference	Mounting information	Magnum	Cab damper	Original equipment cross-reference	Mounting information
MERCEDES-BENZ <i>continued</i>									
All	Actros, Axor: 3331, 3340, 3343, 3348, 3353	"T1197" OR T1207 OR T1220 OR T5360	CB0148 OR CB0100	T1197 OE# 0023231500 0023235300 0043234300 0043236100 0063233300 0063233300 0063234000 0063237400 A006323 3300 T1207 OE# 0053239700 0063231600 0063232100 0063233800 0063236500 0063237100 0063237200 3753230100 A0053239700 T1220 OE# 0033232000 0033232100 0043235600 0063235100 0063236000 0063237800 0063237900 3573230000 3753230000 T5360 OE# 0053239900 0063238300 A0053239900 A0063238300 CB0148 OE# 942 890 0519 958 317 0703 A942 890 0519 A958 317 0703 CB0100 OE# 942 890 2219 942 890 2819 A942 890 2819	⊖ ⊖	T1201 OR T1210 OR T5137 OR T5256 OR T5372	"CB0097" OR CB0096 OR "CB0263"	T1201 OE#'s = 0053260900 / 0053265700 / 0053265800 / 0053265900 / 0053266300 / A0053260900 T1210 OE# = 005 326 1000 A005 326 1000 T5372 OE# = 005 326 6000 005 326 6400 A005 326 6000 T5137 OE# 0053261200 0063265600 A0053261200 T5256 OE# 0053261400 0063260500 A0053261400 CB0097 OE# 9408903919 CB0096 OE# 942 890 4719 A942 890 4719 CB0144 OE# 942 890 3919 943 890 1319 A942 890 3919 A943 890 1319 CB0263 OE# 9408900819, 9408900919, 9408901319, 9408901519, 9583170403,	CB0097, CB0096 ⊖ ⊖ (shock only) ID = 12mm CB0263 (incl spring) ⊖ ⊗ ID = 14mm
All	3535	T1016 *13	-	T1016 OE# = 002 323 3200 002 323 5800 002 323 5900 002 323 7200 002 323 7300 002 323 8600 002 323 8700 002 326 9500 003 323 7100 003 323 9700 003 326 0200 003 326 7700 004 323 0000 004 323 0100 004 323 4400 004 323 4500 004 323 4600 004 323 5200 004 323 6400 004 323 9700 004 323 9800 006 323 0700 006 323 0800 A004 323 4500	⊖ ⊖	-	-	-	

Key

*	See important installation information on inside front cover
!	Excluding self-levelling suspension
"..."	Special order - phone 010 900 1850. 6-12 week waiting period

~	Imported
#	Internal bump stop
⊖	Steering damper

- It is recommended that all new shock absorbers are fitted in pairs
- Do not mix gas and non-gas units on the same axle
- **Bold** part numbers indicate heavy-duty shocks
- Underlined part numbers indicate parts not immediately available
- *Italic* part numbers followed by > indicate parts to be discontinued
- *13 Check the OE part number on the old shock for the correct application

Truck, bus and trailer

Part number [alphabetical listing]

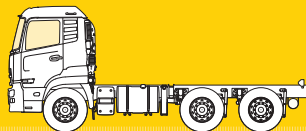

Year	Application	Front				Rear			
		Magnum	Cab damper	Original equipment cross-reference	Mounting information	Magnum	Cab damper	Original equipment cross-reference	Mounting information
MERCEDES-BENZ continued									
All	Actros 4140, 4144, 4148	T1220 OR T5360	CB0122 OR CB0129 OR CB0148 OR CB0100	T1220 OE# = 0033232000 0033232100 0043235600 0063235100 0063236000 0063237800 0063237900 3573230000 3753230000 A0063235100 T5360 OE# = 0053239900 0063238300 A0053239900 A0063238300 CB0122 OE# = 942 890 5419 943 890 0319 CB0129 OE# = 942 890 5019 A942 890 5019 CB0148 OE# = 942 890 0519 958 317 0703 A942 890 0519 A958 317 0703 CB0100 OE# = 942 890 2219 942 890 2819 A942 890 2819	T1220, T5360 (air susp), CB0122, CB0129 (incl coil spring), CB0148, CB0100 (incl coil spring) All = ⊕ ⊖	T5137	"CB0097" OR CB0090 OR CB0158 OR CB0096 OR "CB0263"	T5137 OE# 0053261200 0063265600 A0053261200 CB0097 OE# 9408903919 CB0090 OE# 942 890 0219 942 890 6019 943 890 3919 A942 890 0219 CB0096 OE# 942 890 4719 A942 890 4719 CB0263 OE# 9408900819, 9408900919, 9408901319, 9408901519, 9583170403,	T5137 ⊕ ⊖ ID = 20mm CB0097, CB0096 ⊕ ⊖ (shock only) ID = 12mm CB0090 ⊕ ⊖ (air susp) ID = 14mm CB0263 (incl spring) ⊕ ⊗ ID = 14mm
All	MK	T1220		T1220 OE# = 0033232000 0033232100 0043235600 0063235100 0063236000 0063237800 0063237900 3573230000 3753230000 A0063235100	T1220 = ⊕ ⊖	CB0140	CB0140 OE# 620 890 0019 620 890 0119 A620 890 0019 A620 890 0119	CB0140 = ⊥ ⊗	
All	NG	T1220		T1220 OE# = 0033232000 0033232100 0043235600 0063235100 0063236000 0063237800 0063237900 3573230000 3753230000 A0063235100	T1220 = ⊕ ⊖	CB0140	CB0140 OE# 620 890 0019 620 890 0119 A620 890 0019 A620 890 0119	CB0140 = ⊥ ⊗	
All	SK					CB0140	CB0140 OE# 620 890 0019 620 890 0119 A620 890 0019 A620 890 0119	CB0140 = ⊥ ⊗	

Key to Mercedes-Benz codes: L - Truck | LK - Tipper | LP - Forward control | LS - Mechanical horse | LB - Concrete mixer | LA - 4x4 | LAB - 4x4 Concrete mixer | LAK - 4x4 Tipper | LAS - 4x4 Mechanical horse

MITSUBISHI									
FE Fusio									
All	FE Fusio Truck	66639MM	-	OE# = MC091950 / MC091947	⊥ ○	-	-		
FK Fusio									
98-On	FK Fusio Truck	66639MM	-	OE# = MC091950 / MC091947	⊥ ○	-	-		
FM Fusio									
00-On	FM Fusio Truck	66639MM	-	OE# = MC091950 / MC091947	⊥ ○	-	-		
NEWAY									
All	Neway truck & tractor AD123 & AD246 Drive axle	-	-			65418 -	-	OE# = 90045099	⊕ ⊖

Key

*	See important installation information on inside front cover
!	Excluding self-levelling suspension
"..."	Special order - phone 010 900 1850. 6-12 week waiting period

~	Imported
#	Internal bump stop
⊕	Steering damper

- It is recommended that all new shock absorbers are fitted in pairs
- Do not mix gas and non-gas units on the same axle
- **Bold** part numbers indicate heavy-duty shocks
- Underlined part numbers indicate parts not immediately available
- *Italic* part numbers followed by > indicate parts to be discontinued
- *13 Check the OE part number on the old shock for the correct application

Truck, bus and trailer

Part number [alphabetical listing]

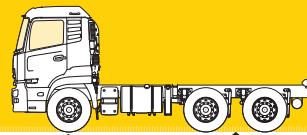

R

Year	Application	Front				Rear			
		Magnum	Cab damper	Original equipment cross-reference	Mounting information	Magnum	Cab damper	Original equipment cross-reference	Mounting information
NISSAN									
Cabstar									
69-76	A320, A321	—	—			"V1029"	—		○ T
98-06	TL75.28, TL90.32	V1132	—		⊥ ○	V1133	—		○ ○
UD 30, 40									
96-on	UD30, UD35A, UD40L	M4434	—		⊥ ○	—	—		
UD 80									
97-on	UD80	T5052 OR T5053	—		⊥ ⊕ (20mm ID, 377mm / 621mm)	—	—		
UD 90, 100									
All	UD85, 90, 100, 2600, 2800, 3000, 3300	66625MM >	—	Check OE #'s 66625 OE#'s = 5610135014, 1-51630-180-3	⊕ ⊕	—	—		
OSHKOSH									
00-On	E Series	B0001 >	—		⊕ ⊕	—	—		
PETERBILT HEAVY COMMERCIAL									
All	Peterbilt Trucks: 330, 357, 362 COE, 365 COE Air susp, 372 COE, 375, 376, 377, 378, 379, 385, 387		—		⊕ ⊕	65492	—	65492 OE# = 0307421	65492 = ⊕ ⊕
	CAB DAMPER	—	66104MM	66104 = OE# = 1202-0054	⊕ ⊕				
POWERSTAR									
All	26.28 10 ton tipper	T1204 OR T1016		Check dimensions	⊕ ⊕ (16 id eyes, closed = 490mm, open = 806mm)				
RENAULT									
94-on	Renault AE385Ti & AE420Ti	T1223 OR "T5179"	—	T1223 OE# = 5000752729 5010052920 5010294412 5010294413 5010383049 5010383050 5010383693 5010383694 T5179 OE# = 5010130401 5010383692 5010557487	⊥ ⊥	T5227 OR "T5078" OR "T5154"	—	T5227 OE# = 5010130009 5010383701 T5078 OE# = 5001863291 5010137052 T5154 OE# = 5010294158 5010383689 5010600393	T5227 = ⊥ T (leaf spring) T5078, T5154 = ⊕ ⊕ (Air susp)
All	Renault KERAX trucks 2544K, 2544L, 2644, 2644AK, 2650, 3235, 3235K		CB0046 OR CB0075	CB0046 OE# 5010269605 5010269605C 5010460113 5010615880 7420840318 CB0075 OE# 5010130797 5010629414	CB0046 ⊕ ⊕ (ID = 14mm, closed 211mm / open 266mm) CB0075 (airspring)	CB0140 OR CB0064 OR CB0109 OR CB0118		CB0140 OE# 620 890 0019 620 890 0119 A620 890 0019 A620 890 0119 CB0064 OE# 5010552010 5010629471 CB0109 OE# 5010460318 5010532897 5010629397 CB0118 OE# 5010552241 7420898055 7482052893 82052893	CB0140 = ⊥ ⊗ (coil) CB0064 ⊕ ⊕ CB0109 ⊕ ⊕ (with coil spring) CB0118 ⊥ ⊗ (with air spring)
All	Renault MIDLUM	"V2099"		V2099 OE# 5010383498, 5010488147, 5010600336, 5010630782	⊥ ⊕ (ID = 20mm, closed 463mm / open 698mm)				

Key

*	See important installation information on inside front cover
!	Excluding self-levelling suspension
"..."	Special order – phone 010 900 1850. 6-12 week waiting period

~	Imported
#	Internal bump stop
⊕	Steering damper

- It is recommended that all new shock absorbers are fitted in pairs
- Do not mix gas and non-gas units on the same axle
- **Bold** part numbers indicate heavy-duty shocks
- Underlined part numbers indicate parts not immediately available
- *Italic* part numbers followed by > indicate parts to be discontinued
- *13 Check the OE part number on the old shock for the correct application

Truck, bus and trailer

Part number [alphabetical listing]

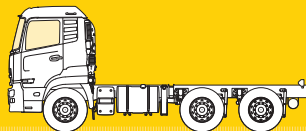

Year	Application	Front				Rear			
		Magnum	Cab damper	Original equipment cross-reference	Mounting information	Magnum	Cab damper	Original equipment cross-reference	Mounting information
RENAULT <small>continued</small>									
All	Renault PREMIUM & PREMIUM 2 trucks		CB0046 or CB0075	CB0046 OE# 5010269605 5010269605C 5010460113 5010615880 7420840318 CB0075 OE# 5010130797 5010629414	CB0046 ⊕ ⊕ (ID = 14mm, closed 211mm / open 266mm) CB0075 (airspring)	T5444	CB0064 or CB0109 or CB0118 or CB0171	T5444 OE# 7420749710, 7421243062, 7421909833 CB0064 OE# 5010552010 5010629471 CB0109 OE# 5010460318 5010532897 5010629397 CB0118 OE# 20898055 5010552241 7420898055 7482052893 82052893 CB0171 OE# 5010615879	T5444 ⊥ ⊕ CB0064 ⊕ ⊕ CB0109 ⊕ ⊕ (with coil spring) CB0118 ⊥ ⊗ (with air spring) CB0171 ⊗ ⊕ (with air spring)

SAMAG / SAMIL									
All	SAMIL 20	T1346	—		⊕ ⊕ (ID = 16mm, closed 438mm / open 714mm)	T1093	—		⊥ ⊥ (Closed 401mm / open 692mm)
All	SAMIL 50	T5360	—		⊕ ⊕ (ID = 16mm, closed 446mm / open 729mm)	—	—		⊥ ⊥
All	SAMIL 100	T5360	—		⊕ ⊕ (ID = 16mm, closed 446mm / open 729mm)	—	—		

SCANIA									
All	Scania 35, 41					—	CB0105	CB0105 OE# = 13 46416 50 81 41722 6010 81 41722 6013 81 41722 6017 81 41722 6045	⊕ ⊕
87-'98	Scania 3 Series	T5063		T5063 OE# = 1327145 1327813 1331756	⊥ ⊕		CB0066 or CB0065	CB0066 OE# = 1116535 1117320 1117326 1117334 1331620 1331621 1331626 1331634 1331635 1348117 1348118 1348121 370227 393257 550365 CB0065 OE# = 1116535, 1117320, 1117334, 1331620, 1331621, 1331634, 1331635, 1348117, 1348118, 1348119, 1348120, 370227, 393257, 550365	CB0066 (airspring only) CB0065 (shock) = ⊥ ⊕

Key

*	See important installation information on inside front cover
!	Excluding self-levelling suspension
"..."	Special order – phone 010 900 1850. 6-12 week waiting period

~	Imported
#	Internal bump stop
⊕	Steering damper

- It is recommended that all new shock absorbers are fitted in pairs
- Do not mix gas and non-gas units on the same axle
- **Bold** part numbers indicate heavy-duty shocks
- Underlined part numbers indicate parts not immediately available
- *Italic* part numbers followed by > indicate parts to be discontinued
- *13 Check the OE part number on the old shock for the correct application

Truck, bus and trailer

Part number [alphabetical listing]

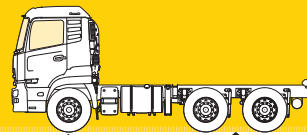

Year	Application	Front				Rear			
		Magnum	Cab damper	Original equipment cross-reference	Mounting information	Magnum	Cab damper	Original equipment cross-reference	Mounting information
SCANIA continued									
98-04	Scania 4 Series	"T5356"	CB0066 OR CB0065	T5356 OE# = 1388416 1519629 CB0066 OE# = 1116535 1117320 1117326 1117334 1331620 1331621 1331626 1331634 1331635 1348117 1348118 1348121 370227 393257 550365 CB0065 OE# = 1116535, 1117320, 1117334, 1331620, 1331621, 1331634, 1331635, 1348117, 1348118, 1348119, 1348120, 370227, 393257, 550365	T5356 = ⊥ ⊤ CB0066 (airspring only) CB0065 (shock) = ⊥ ⊕	T5391	"CB0173" OR CB0066 OR CB0065	T5391 CB0173 OE# = 1381905 1381906 1381919 1381906 1476415 1397393 1397397 1397398 1381919 1397398 1476415 1435853 1435856 1381919 1435856 1476415 CB0066 OE# = 1116535 1117320 1117326 1117334 1331620 1331621 1331626 1331634 1331635 1348117 1348118 1348121 370227 393257 550365 CB0065 OE# = 1116535, 1117320, 1117334, 1331620, 1331621, 1331634, 1331635, 1348117, 1348118, 1348119, 1348120, 370227, 393257, 550365	CB0173 (incl air spring) = ⊥ ⊤ CB0066 (airspring only) CB0065 (shock) = ⊥ ⊕
All	Scania 82	T1101 > T1331	-	T1331 (also T1101) OE# = 1012044 1340252 1381807 279011 1110588 1111056 1356723 1388417 1421062 395063	⊥ ○	T5059	-	T5059 OE# = 1377056	⊥ ⊕
All	Scania 92	T1101 > T1331 OR T1330	-	T1331 (also T1101) OE# = 1012044 1340252 1381807 279011 1110588 1111056 1356723 1388417 1421062 395063 T1330 OE# = 1370267 1867874 1868263	T5237, T5241, T1100, T1331 = ⊥ ⊕ T1330 = ⊥ ○	T5059	-	T5059 OE# = 1377056	⊥ ⊕
All	Scania 93	T1101 > T1331 OR T1330	-	T1331 OE# = 1110588 1111056 1356723 1388417 1421062 395063 T1330 OE# = 1370267 1867874 1868263	T1331 = ⊥ ○ T1330 (air susp) = ⊥ ○	"T5145" OR T5059 OR T5243	-	T5145 OE# = 1380424 T5059 OE# = 1377056 T5243 OE#s = 1340254 1353105 1381809 272400	T5145 = ⊕ ⊕ T5059, T5243 = ⊥ ⊕
	Cab Damper						CB0015	CB0015 OE# = 370228 393208 393290	⊥ ⊕

Key

*	See important installation information on inside front cover
!	Excluding self-levelling suspension
"..."	Special order - phone 010 900 1850. 6-12 week waiting period

Key

~	Imported
#	Internal bump stop
⊕	Steering damper

- It is recommended that all new shock absorbers are fitted in pairs
- Do not mix gas and non-gas units on the same axle
- **Bold** part numbers indicate heavy-duty shocks
- Underlined part numbers indicate parts not immediately available
- *Italic* part numbers followed by > indicate parts to be discontinued
- *13 Check the OE part number on the old shock for the correct application

Truck, bus and trailer

Part number [alphabetical listing]

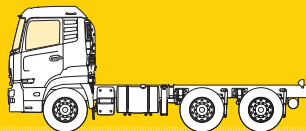

Year	Application	Front				Rear			
		Magnum	Cab damper	Original equipment cross-reference	Mounting information	Magnum	Cab damper	Original equipment cross-reference	Mounting information
SCANIA continued									
All	Scania 94	T1215 OR T1145 OR T1330 OR "T5356"	—	T1215 OE# = 1371447 1371448 1438527 1478499 1478500 1478541 T1145 OE# = 1315959 1370267 1420474 T1330 OE# = 1370267 1867874 1868263 T5356 OE# = 1388416 1519629	T1215, T1145 = ⊥ ⊕ T1330 = ⊥ ○ T5356 = ⊥ ⊤	T5144 OR "T5145" OR "T5242" OR T1216 OR T1296 OR T5387	—	T5144 OE# = 1380425 & 1397523 T5145 OE# = 1380424 T5242 OE# = 1397525 T1216 OE# = 1401877 1454753 1478511 T1296 OE# = 1427423 1427424 2031227 2031228 T5387 OE# = 1380427 1478509 1519633	T5144, T5145 & T5387 (air), T1296 (leaf) = ⊥ ⊕ T5242 = ⊥ ⊤ T1216 (air) = ⊥ ⊕
	94 CAB DAMPER	—	CB0010 OR CB0011 OR CB0030 OR CB0058 OR CB0067 OR CB0130 OR CB0172	CB0010 OE# = 1381904 1397396 1397400 1435859 CB0010 OE# = 1397386 1397388 1397390 1397392 1431745 1431746 1431747 1431748 CB0030 OE# 1381919 1476415 CB0058 OE# 1363120 1363122 1424227 1424228 CB0067 OE# 1349840 1424231 CB0130 OE# 1444016 CB0172 OE# 1381903 1381904/1381919 1381904/1476415 1397395 1397399 1397400/1381919 1397400/1476415 1435852 1435859/1381919	CB0010, CB0011, CB0058 = ⊥ ⊤ (air spring) CB0030, CB0067, CB0130 = (airspring) CB0172 (damper + airspring)	CB0134 OR CB0078 OR CB0009 OR CB0010 OR CB0011 OR CB0030 OR CB0059 OR CB0067 OR CB0074 OR CB0130 OR "CB0173" OR CB0195	CB0134 OE# = 1505563 CB0078 OE# = 1502470 1502471 1502474 CB0009 OE# 1381906 1397394 1397398 1402271 1435856 CB0010 OE# = 1381904 1397396 1397400 1435859 CB0011 OE# 1397386 1397388 1397390 1397392 1431745 1431746 1431747 1431748 CB0030 OE# 1381919 1476415 CB0059 OE# 1349844 1382826 1382827 1382829 1424229 CB0067 OE# 1349840 1424231 CB0074 OE# 1502468 CB0130 OE# 1444016 CB0173 OE# 1381905 1381906 1381919 1381906 1476415 1397393 1397397 1397398 1381919 1397398 1476415 1435853 1435856 1381919 1435856 1476415 CB0195 OE# 2477273, 1502468, 2453686, 1870893, 2493170, 1502472, 1871658	CB0134, CB0078, CB0009 = ⊥ ⊕ (air spring) CB0010, CB0011, CB0059 = ⊥ ⊤ (air spring) CB0173 = ⊥ ⊤ (air spring) CB0030, CB0067, CB0074, CB0130 = (airspring) CB0195 = ⊥ ⊕ (air spring)	
All	Scania 112	T1100 > OR T1101 > T1331 OR T1330	—	T1100 OE# = 307111 T1331 OE# = 1012044 1340252 1381807 279011 (air spring) T1101 OE# = 1110588 1111056 1356723 1388417 1421062 395063 T1330 OE# = 1370267 1867874 1868263	T1100, T1331 = ⊥ ⊕ T1330 = ⊥ ○	T5059	—	T5059 OE# = 1377056	T5059 = ⊥ ⊕

Key

*	See important installation information on inside front cover
!	Excluding self-levelling suspension
...	Special order – phone 010 900 1850. 6-12 week waiting period

~	Imported
#	Internal bump stop
⊕	Steering damper

- It is recommended that all new shock absorbers are fitted in pairs
- Do not mix gas and non-gas units on the same axle
- **Bold** part numbers indicate heavy-duty shocks
- Underlined part numbers indicate parts not immediately available
- *Italic* part numbers followed by > indicate parts to be discontinued
- *13 Check the OE part number on the old shock for the correct application

Truck, bus and trailer

Part number [alphabetical listing]

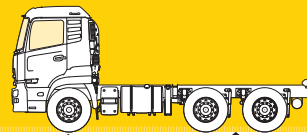

Year	Application	Front				Rear			
		Magnum	Cab damper	Original equipment cross-reference	Mounting information	Magnum	Cab damper	Original equipment cross-reference	Mounting information
SCANIA continued									
All	Scania 113	T1101 > T1331 OR T1145	—	T1331 OE# = 1110588 1111056 1356723 1388417 1421062 395063 T1145 OE# = 1315959 1370267 1420474	⊥ ⊕	T5059	—	T5059 OE# = 1377056	T5059 = ⊥ ⊕
	Cab Damper					CB0015		CB0015 OE# = 370228 393208 393290	⊥ ⊕
All	Scania 114	T1215 OR T1330 OR "T5356"	—	T1215 OE# = 1371447 / 1371448 / 1478499 / 1478500 T1330 OE# = 1370267 1867874 1868263 T5356 OE# = 1388416 1519629	T1215 = ⊥ ⊕ T1330 = ⊥ ○ T5356 = ⊥ T	T5144 OR "T5145" OR T1216 OR T1296 OR T5387	—	T5144 OE# = 1380425 & 1397523 T5145 OE# = 1380424 T1216 OE# = 1401877 1454753 1478511 T1296 OE# = 1427423 1427424 2031227 2031228 T5387 OE# = 1380427 1478509 1519633	T5144, T5145 & T5387 (air), T1296 (leaf) = ⊕ ⊕ T1216 (air) = ⊥ ⊕
	114 CAB DAMPER	—	CB0010 OR CB0011 OR CB0030 OR CB0058 OR CB0067 OR CB0130 OR CB0172	CB0010 OE# = 1381904 1397396 1397400 1435859 CB0010 OE# = 1397386 1397388 1397390 1397392 1431745 1431746 1431747 1431748 CB0030 OE# 1381919 1476415 CB0058 OE# 1363120 1363122 1424227 1424228 CB0067 OE# 1349840 1424231 CB0130 OE# 1444016 CB0172 OE# 1381903 1381904/1381919 1381904/1476415 1397395 1397399 1397400/1381919 1397400/1476415 1435852 1435859/1381919	CB0010, CB0011, CB0058 = ⊥ T ⊕ air spring) CB0030, CB0067, CB0130 = (air spring) CB0172 (damper + air spring)	CB0134 OR CB0078 OR CB0009 OR CB0010 OR CB0011 OR CB0030 OR CB0059 OR CB0067 OR CB0074 OR CB0130 OR "CB0173" OR CB0195	CB0134 OE# = 1505563 CB0078 OE# = 1502470 1502471 1502474 CB0009 OE# 1381906 1397394 1397398 1402271 1435856 CB0010 OE# = 1381904 1397396 1397400 1435859 CB0011 OE# 1397386 1397388 1397390 1397392 1431745 1431746 1431747 1431748 CB0030 OE# 1381919 1476415 CB0059 OE# 1349844 1382826 1382827 1382829 1424229 CB0067 OE# 1349840 1424231 CB0074 OE# 1502468 CB0130 OE# 1444016 CB0173 OE# 1381905 1381906 1381919 1381906 1476415 1397393 1397397 1397398 1381919 1397398 1476415 1435853 1435856 1381919 1435856 1476415 CB0195 OE# 2477273, 1502468, 2453686, 1870893, 2493170, 1502472, 1871658	CB0134, CB0078, CB0009 = ⊥ ⊕ ⊕ air spring) CB0010, CB0011, CB0059 = ⊥ T ⊕ air spring) CB0173 = ⊥ T ⊕ air spring) CB0030, CB0067, CB0074, CB0130 = (air spring) CB0195 = ⊥ ⊕ ⊕ air spring)	

Key	
*	See important installation information on inside front cover
!	Excluding self-levelling suspension
"..."	Special order – phone 010 900 1850. 6-12 week waiting period

~	Imported
#	Internal bump stop
⊕	Steering damper

- It is recommended that all new shock absorbers are fitted in pairs
- Do not mix gas and non-gas units on the same axle
- **Bold** part numbers indicate heavy-duty shocks
- Underlined part numbers indicate parts not immediately available
- *Italic* part numbers followed by > indicate parts to be discontinued
- *13 Check the OE part number on the old shock for the correct application

Truck, bus and trailer

Part number [alphabetical listing]

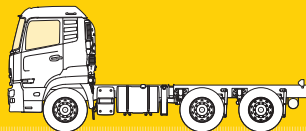

Year	Application	Front				Rear				
		Magnum	Cab damper	Original equipment cross-reference	Mounting information	Magnum	Cab damper	Original equipment cross-reference	Mounting information	
SCANIA continued										
All	Scania 123	T1330 OR T5063		T1330 OE# = 1370267 1867874 1868263 T5063 OE# = 1327145 1327813 1331756	⊥ ⊕					⊥ ⊥
All	Scania 124	T1215 OR T1330 OR "T5356"	—	T1215 OE# = 1371447 / 1371448 / 1478499 / 1478500 T1330 OE# = 1370267 1867874 1868263 T5356 OE# = 1388416 1519629	T1215 = ⊥ ⊕ T1330 = ⊥ ⊙ T5356 = ⊥ ⊥	T5144 OR "T5145" OR T1216 OR T1296 OR T5387	—	T5144 OE# = 1380425 & 1397523 T5145 OE# = 1380424 99474620 T1216 OE# = 1401877 1454753 1478511 T1296 OE# = 1427423 1427424 2031227 2031228 T5387 OE# = 1380427 1478509 1519633	T5144, T5145 & T5387 (air), T1296 (leaf) = ⊕ ⊕ T1216 (air) = ⊥ ⊕	
	124 Cab Damper		CB0010 OR CB0011 OR CB0030 OR CB0058 OR CB0067 OR CB0130 OR CB0172	CB0010 OE# = 1381904 1397396 1397400 1435859 CB0010 OE# = 1397386 1397388 1397390 1397392 1431745 1431746 1431747 1431748 CB0030 OE# 1381919 1476415 CB0058 OE# 1363120 1363122 1424227 1424228 CB0067 OE# 1349840 1424231 CB0130 OE# 1444016 CB0172 OE# 1381903 1381904/1381919 1381904/1476415 1397395 1397399 1397400/1381919 1397400/1476415 1435852 1435859/1381919	CB0010, CB0011, CB0058 = ⊥ ⊥ (air spring) CB0030, CB0067, CB0130 = (airspring) CB0172 (damper + airspring)	CB0134 OR CB0078 OR CB0009 OR CB0010 OR CB0011 OR CB0030 OR CB0059 OR CB0067 OR CB0074 OR CB0130 OR "CB0173" OR CB0195	CB0134 OE# = 1505563 CB0078 OE# = 1502470 1502471 1502474 CB0009 OE# 1381906 1397394 1397398 1402271 1435856 CB0010 OE# = 1381904 1397396 1397400 1435859 CB0011 OE# 1397386 1397388 1397390 1397392 1431745 1431746 1431747 1431748 CB0030 OE# 1381919 1476415 CB0059 OE# 1349844 1382826 1382827 1382829 1424229 CB0067 OE# 1349840 1424231 CB0074 OE# 1502468 CB0130 OE# 1444016 CB0173 OE# 1381905 1381906 1381919 1381906 1476415 1397393 1397397 1397398 1381919 1397398 1476415 1435853 1435856 1381919 1435856 1476415 CB0195 OE# 2477273, 1502468, 2453686, 1870893, 2493170, 1502472, 1871658	CB0134, CB0078, CB0009 = ⊥ ⊕ (air spring) CB0010, CB0011, CB0059 = ⊥ ⊥ (air spring) CB0173 = ⊥ ⊥ (air spring) CB0030, CB0067, CB0074, CB0130 = (airspring) CB0195 = ⊥ ⊕ (air spring)		

Key

*	See important installation information on inside front cover
!	Excluding self-levelling suspension
"..."	Special order – phone 010 900 1850. 6-12 week waiting period

~	Imported
#	Internal bump stop
⊕	Steering damper

- It is recommended that all new shock absorbers are fitted in pairs
- Do not mix gas and non-gas units on the same axle
- **Bold** part numbers indicate heavy-duty shocks
- Underlined part numbers indicate parts not immediately available
- *Italic* part numbers followed by > indicate parts to be discontinued
- *13 Check the OE part number on the old shock for the correct application

Truck, bus and trailer

Part number [alphabetical listing]

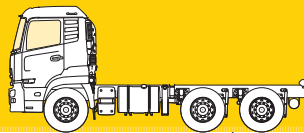

Year	Application	Front				Rear			
		Magnum	Cab damper	Original equipment cross-reference	Mounting information	Magnum	Cab damper	Original equipment cross-reference	Mounting information
SCANIA continued									
All	Scania 142	T1331 OR T1330	—	T5237 OE# = 1340257 1481716 372291 T5241 OE# = 1012044 1340252 1381807 279011 T1100 OE# = 307111 T1101 OE# = 1110588 1111056 1356723 1388417 1421062 395063 T1330 OE# = 1370267 1867874 1868263	T5237, T5241, T1100, T1101 = ⊥ ⊕ T1330 = ⊥ ○	T5059	—	T5059 OE# = 1377056	T5059 = ⊥ ⊕
All	Scania 143	<i>T1101</i> > <u>T1331</u> OR T1145 OR T1330	—	T1331 OE# = 1110588 1111056 1356723 1388417 1421062 395063 T1145 OE# = 1315959 1370267 1420474 T1330 OE# = 1370267 1867874 1868263	T1331, T1145 = ⊥ ⊕ T1330 = ⊥ ○	T5059	—	T5059 OE# = 1377056	T5059 = ⊥ ⊕
	Cab Damper					CB0015		CB0015 OE# = 370228 393208 393290	⊥ ⊕
All	Scania 144	T1215 OR T1330 OR "T5356"	—	T1215 OE# = 1371447 1371448 1438527 1478499 1478500 1478541 T1330 OE# = 1370267 1867874 1868263 T5356 OE# = 1388416 1519629	T1215 = ⊥ ⊕ T1330 = ⊥ ○ T5356 = ⊥ T	T5144 OR "T5145" OR T1216 OR T1296 OR T5387	—	T5144 OE# = 1380425 & 1397523 T5145 OE# = 1380424 T1216 OE# = 1401877 1454753 1478511 T1296 OE# = 1427423 1427424 2031227 2031228 T5387 OE# = 1380427 1478509 1519633	T5144, T5145 & T5387 (air), T1296 (leaf) = ⊕ ⊕ T1216 (air) = ⊥ ⊕

Key

*	See important installation information on inside front cover
!	Excluding self-levelling suspension
"..."	Special order – phone 010 900 1850. 6-12 week waiting period

~	Imported
#	Internal bump stop
⊕	Steering damper

- It is recommended that all new shock absorbers are fitted in pairs
- Do not mix gas and non-gas units on the same axle
- **Bold** part numbers indicate heavy-duty shocks
- Underlined part numbers indicate parts not immediately available
- *Italic* part numbers followed by > indicate parts to be discontinued
- *13 Check the OE part number on the old shock for the correct application

Truck, bus and trailer

Part number [alphabetical listing]

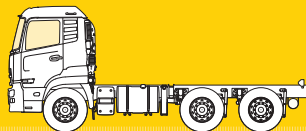

Year	Application	Front				Rear				
		Magnum	Cab damper	Original equipment cross-reference	Mounting information	Magnum	Cab damper	Original equipment cross-reference	Mounting information	
SCANIA continued										
	Scania 144 & 164 CAB DAMPER	—	CB0010 or CB0011 or CB0030 or CB0058 or CB0067 or CB0130 or CB0172	CB0010 OE# = 1381904 1397396 1397400 1435859 CB0010 OE# = 1397386 1397388 1397390 1397392 1431745 1431746 1431747 1431748 CB0030 OE# 1381919 1476415 CB0058 OE# 1363120 1363122 1424227 1424228 CB0067 OE# 1349840 1424231 CB0130 OE# 1444016 CB0172 OE# 1381903 1381904/1381919 1381904/1476415 1397395 1397399 1397400/1381919 1397400/1476415 1435852 1435859/1381919	CB0010, CB0011, CB0058 = ⊥ T (30) air spring CB0030, CB0067, CB0130 = (air spring) CB0172 (damper + air spring)			CB0134 or CB0078 or CB0009 or CB0010 or CB0011 or CB0030 or CB0059 or CB0067 or CB0074 or CB0130 or "CB0173" or CB0195	CB0134 OE# = 1505563 CB0078 OE# = 1502470 1502471 1502474 CB0009 OE# 1381906 1397394 1397398 1402271 1435856 CB0010 OE# = 1381904 1397396 1397400 1435859 CB0011 OE# 1381906 1397386 1397388 1397390 1397392 1431745 1431746 1431747 1431748 CB0030 OE# 1381919 1476415 CB0059 OE# 1349844 1382826 1382827 1382829 1424229 CB0067 OE# 1349840 1424231 CB0074 OE# 1502468 CB0130 OE# 1444016 CB0173 OE# 1381905 1381906 1381919 1381906 1476415 1397393 1397397 1397398 1381919 1397398 1476415 1435853 1435856 1381919 1435856 1476415 CB0195 OE# 2477273, 1502468, 2453686, 1870893, 2493170, 1502472, 1871658	CB00134, CB0078, CB0009 = ⊥ ⊕ (30) air spring) CB0010, CB0011, CB0059 = ⊥ T (30) air spring) CB0173 = ⊥ T (30) air spring) CB0030, CB0067, CB0074, CB0130 = (air spring) CB0195 = ⊥ ⊕ (30) air spring)

Key

*	See important installation information on inside front cover
!	Excluding self-levelling suspension
...	Special order – phone 010 900 1850. 6-12 week waiting period

~	Imported
#	Internal bump stop
⊕	Steering damper

- It is recommended that all new shock absorbers are fitted in pairs
- Do not mix gas and non-gas units on the same axle
- **Bold** part numbers indicate heavy-duty shocks
- Underlined part numbers indicate parts not immediately available
- *Italic* part numbers followed by > indicate parts to be discontinued
- *13 Check the OE part number on the old shock for the correct application

Truck, bus and trailer

Part number [alphabetical listing]

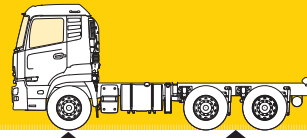

Year	Application	Front				Rear			
		Magnum	Cab damper	Original equipment cross-reference	Mounting information	Magnum	Cab damper	Original equipment cross-reference	Mounting information
SCANIA continued									
P, G, R, T SERIES									
	Scania P, G, R, T - series	T1330 OR "T5356"	CB0078 OR CB0010 OR CB0030 OR CB0058 OR CB0067 OR CB0130 OR CB0172 OR CB0176	T1330 OE# = 1370267 1867874 1868263 T5356 OE# = 1388416 1519629 CB0078 OE# = 1502470 1502471 1502474 CB0010 OE# = 1397386 1397388 1397390 1397392 1431745 1431746 1431747 1431748 CB0030 OE# 1381919 1476415 CB0058 OE# 1363120 1363122 1424227 1424228 CB0067 OE# 1363120 CB0130 OE# 1444016 CB0172 OE# 1381903 1381904 1381919 1381904 1476415 1397395 1397399 1397400 1381919 1397400 1476415 1435852 1435859 1381919 CB0176 OE# = 1466184 1466185 1943267 1943268 2023668	T1330 = ⊥ ⊙ T5356 = ⊥ ⊥ CB0078 = ⊥ ⊙ air spring) CB0010 & CB0058 air spring) = ⊥ ⊥ CB0176 (coil susp) = ⊥ ⊥ & CB0030, CB0067, CB0172 (incl air spring) CB0130 (air spring)	T1296 OR T5387	CB0134 OR CB0067 OR CB0074 OR CB0130	CB0134 OE# = 1505563 CB0067 OE# 1363120 CB0074 OE# 1502468 CB0130 OE# 1444016 T1296 OE# = 1427423 1427424 2031227 2031228 T5387 OE# = 1380427 1478509 1519633	T1296 (leaf), T5387 (air) = ⊙ ⊙ CB0134 = ⊥ ⊙ air spring) CB0067, CB0074, CB0130 (air spring)

TATA									
All	Tata 407 SFC 2T 4x2 F0-C	-	-		⊙ ⊙	"66626MM"	-		⊥ ⊥
All	Tata 509 M 4x2 F-C	-	-		⊙ ⊙	"66626MM"	-		⊥ ⊥
All	Tata 709 LPT 3T 4x2 F-C	"74466MM"	-		⊥ ⊥	"66626MM"	-		⊥ ⊥
All	Tata 713 LPT S 4x2 F-C (incl 713 Bus)	"74466MM"	-		⊥ ⊥	"66626MM"	-		⊥ ⊥
All	Tata 1518C	T5171			⊙ ⊙				

Key	
*	See important installation information on inside front cover
!	Excluding self-levelling suspension
"..."	Special order - phone 010 900 1850. 6-12 week waiting period

~	Imported
#	Internal bump stop
⊙	Steering damper

- It is recommended that all new shock absorbers are fitted in pairs
- Do not mix gas and non-gas units on the same axle
- **Bold** part numbers indicate heavy-duty shocks
- Underlined part numbers indicate parts not immediately available
- *Italic* part numbers followed by > indicate parts to be discontinued
- *13 Check the OE part number on the old shock for the correct application

Truck, bus and trailer

Part number [alphabetical listing]

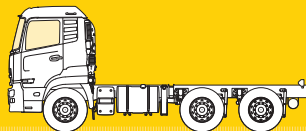

Year	Application	Front				Rear			
		Magnum	Cab damper	Original equipment cross-reference	Mounting information	Magnum	Cab damper	Original equipment cross-reference	Mounting information
TOYOTA									
DA / KA									
00-On	DA/KA Truck	-	-	-	⊥ ○	-	-	-	
Dyna									
66-77	Dyna, Coaster U10	M8039	-	-	○ ○	M8038	-	-	○ ○
78-04	Dyna Y20 / Y30 / Y40	M4464	-	-	⊥ ○ 16id rubber eye bushing	M8038	-	-	○ ○
85-on	Dyna 100 (LH80, YH81, LY100)	"V1042" (shorter than M4464)	-	-	⊥ ○ 12id rubber eye bushing	-	-	-	○ ○
00-on	Dyna U300 - U500 (2 - 3 ton)	-	-	-		M6409	-	-	M6409 ○ ○ 19,5mm, 381mm/620mm M8039 ○ (16mm) ⊕ (12mm) may be able to be used but the bottom rubber will need to be sleeved with a 12mm ID
02-on	Dyna 4-093 4x2 F-C	M7366	-	-	⊥ ⊕	M6409	-	-	○ ○ 19,5mm, 381mm/620mm

For Toyota Hino ... see Hino

VOLVO									
All	F6	-	CB0176	CB0176 OE# = 1466184 1466185 1943267 1943268 2023668	CB0176 = ⊥ T (coil spring)	-	-	-	
All	F10	"T5092"	-	T5092 OE# = 1609002	⊕ ⊕	T5155	-	T5155 OE# = 1598106	⊕ ⊕ (air susp)
All	F12 & F16	T1177 OR "T5092" OR "B1278"	-	T1177 OE# = 1076717 1629478 20374545 3987957 T5092 OE# = 1609002 B1278 OE# 8152712	T1177, T5092 ⊕ ⊕ B1278 ⊥ T	T5155	-	T5155 OE# = 1598106	T5155 (air susp) = ⊕ ⊕
All	FE	-	CB0046	CB0046 OE# 20721849 20840318	CB0046 ⊕ ⊕ (ID = 14mm, closed 211mm / open 266mm)	CB0064 OR CB0109 OR CB0118	-	CB0064 OE# 25379070 CB0109 OE# 20593746 CB0118 OE# 20591650 82052893	CB0064= ⊕ ⊕ CB0109= ⊕ ⊕ (with spring) CB0118 = ⊥ ⊗ (with air spring)
All	FH & FH 2 & FH3	T1388	CB0205	T1388 OE# 21866530 CB0205 OE# 21170510, 21739591, 23111320, 23111328, 22040653, 23111324	⊕ ⊕ = T1388 ⊥ ⊕ = CB0205 (excl air)	T5444	CB0175	T5444 OE# : 21243049, 21909826, 23409864 CB0175 OE# = 21739593, 22040665	T5444 = ⊥ ⊕ CB0175 = ⊕ ⊕
All	FH12	"T1179" OR T1177 OR "T1180" OR "T5184"	-	T1179 OE# = 1629481 1629920 3987961 T1177 OE# = 1076717 1629478 20374545 3987957 T1180 OE# = 3987959 T5184 OE# = 20374546	⊕ ⊕	"T5170" OR "T5091" OR "T1179" OR "T1180" OR T1360 OR T5107 OR T5177	-	T5170 OE# = 20374543 & 2058556 T5091 OE# = 1629405 T1360 OE# = 20709798 20883347 T5107 OE# = 1629484 T5177 OE# = 1079150 20374544 20585555 21172388	T5170, T1179, T1180, T1360, T5177 (air) = ⊕ ⊕ T5091 (leaf), T5107 (air) = ⊕ T

Key

*	See important installation information on inside front cover
!	Excluding self-levelling suspension
...	Special order - phone 010 900 1850. 6-12 week waiting period

~	Imported
#	Internal bump stop
⊕	Steering damper

- It is recommended that all new shock absorbers are fitted in pairs
- Do not mix gas and non-gas units on the same axle
- **Bold** part numbers indicate heavy-duty shocks
- Underlined part numbers indicate parts not immediately available
- *Italic* part numbers followed by > indicate parts to be discontinued
- *13 Check the OE part number on the old shock for the correct application

Truck, bus and trailer

Part number [alphabetical listing]

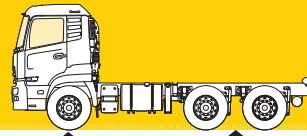

Year	Application	Front				Rear			
		Magnum	Cab damper	Original equipment cross-reference	Mounting information	Magnum	Cab damper	Original equipment cross-reference	Mounting information
VOLVO continued									
	FH12 Cabin Damper	—	"CB0028" OR CB0006 OR CB0007 OR CB0040 OR CB0055 OR CB0004 OR "CB0003" OR "CB0039" OR "CB0214"	CB0028 OE# = 1629722, CB0006 OE#s = 20427897 20721169 20736464 20775212 CB0007 OE#s = 1622227 3198849 3986315 CB0040 OE# = 3198838 CB0055 OE#s = 20399204 20453256 20453258 3198837 20453256 20889132 21111932 CB0004 OE# = 1076860 20721166 21137458 3172986 3198859 CB0003 OE# 1629719 1629724 3172984 CB0039 OE# 20453256 20453258 20889132 20889136 21111932 21111942 3198837 CB0214 OE# 20453256 20889132 21111932	CB0028, CB0006, CB0007, CB0004, CB0003 (airsusp) = ⊖ ⊖ CB0040 (shock only no coil spring. No top rubbers – order MK800), CB0214 (incl airspring) CB0039 (excl air spring) = ⊥ ⊖ (no top rubbers order MK800) CB0055 = (airspring)	—	CB0001 OR CB0006 OR CB0019 OR CB0029 OR CB0213 OR CB0208 OR CB0204	CB0001 OE# = 20427897 20721167 20889138 21032337 21651229 3198850 CB0006 OE# = 1076855 20427897 20721169 20775212 20889134 21651231 3172985 CB0019 OE# = 1099672 CB0029 OE# = 1629721 CB0213 OE# = 21171976 22040666 CB0208 OE# = 21171975 22128971 CB0204 OE# = 21168663	CB0001, CB0006 = ⊖ ⊖ (incl airspring) CB0019, CB0029 = ⊖ ⊖ CB0213 = ⊖ ⊖ (incl airspring) CB0204 = ⊖ ⊖ (20mm ID) CB0208 = ⊥ ⊖
All	FH16	—	"T5184" OR T1388	T5184 OE# = 20374546 T1388 OE# 21866530	⊖ ⊖	"T1179" OR "T5170" OR "T5091" OR "T1180" OR T1360 OR T5177 OR T5444	T1179 OE# = 1629481 1629920 3987961 T5170 OE# = 20374543 & 2058556 T5091 OE# = 1629405 T1180 OE# = 3987959 T1360 OE# = 20709798 20883347 T5177 OE# = 1079150 20374544 20585555 21172388 T5444 OE#: 21243049, 21909826, 23409864	T1179, T5170, T1180, T1360, T5177 (air) = ⊖ ⊖ T5091 = ⊖ ⊥ T5444 = ⊥ ⊖	
	FH16 Cabin Damper	—	"CB0028" OR CB0006 OR CB0007 OR CB0055 OR CB0004 OR "CB0003" OR "CB0039" OR "CB0214" OR CB0205	CB0028 OE# = 1629722, CB0006 OE#s = 20427897 20721169 20736464 20775212 CB0007 OE#s = 1622227 3198849 3986315 CB0055 OE#s = 20399204 20453256 20453258 3198837 20453256 20889132 21111932 CB0004 OE# = 1076860 20721166 21137458 3172986 3198859 CB0003 OE# 1629719 1629724 3172984 CB0039 OE# 20453256 20453258 20889132 20889136 21111932 21111942 3198837 CB0214 OE# 20453256 20889132 21111932 CB0205 OE# 21170510, 21739591, 23111320, 23111328, 22040653, 23111324	CB0028, CB0006, CB0007, CB0004, CB0003 (airsusp) = ⊖ ⊖ CB0055 = (airspring) CB0039 (excl air spring), (no top rubbers order MK800), CB0214 (incl airspring) = ⊥ ⊖ CB0205 (excl air) = ⊥ ⊖	—	CB0001 OR CB0006 OR CB0019 OR CB0029 OR CB0213 OR CB0208 OR CB0204 OR CB0175	CB0001 OE# = 20427897 20721167 20889138 21032337 21651229 3198850 CB0006 OE# = 1076855 20427897 20721169 20775212 20889134 21651231 3172985 CB0019 OE# = 1099672 CB0029 OE# = 1629721 CB0213 OE# = 21171976 22040666 CB0208 OE# = 21171975 22128971 CB0204 OE# = 21168663 CB0175 OE# = 21739593, 22040665	CB0001, CB0006 = ⊖ ⊖ (incl airspring) CB0019, CB0029 = ⊖ ⊖ CB0213 = ⊖ ⊖ (incl airspring) CB0204 = ⊖ ⊖ (20mm ID) CB0208 = ⊥ ⊖

Key	
*	See important installation information on inside front cover
!	Excluding self-levelling suspension
"..."	Special order – phone 010 900 1850. 6-12 week waiting period

~	Imported
#	Internal bump stop
⊖	Steering damper

- It is recommended that all new shock absorbers are fitted in pairs
- Do not mix gas and non-gas units on the same axle
- **Bold** part numbers indicate heavy-duty shocks
- Underlined part numbers indicate parts not immediately available
- *Italic* part numbers followed by > indicate parts to be discontinued
- *13 Check the OE part number on the old shock for the correct application

Truck, bus and trailer

Part number [alphabetical listing]

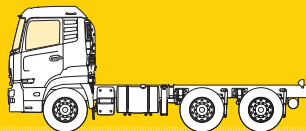

Year	Application	Front				Rear			
		Magnum	Cab damper	Original equipment cross-reference	Mounting information	Magnum	Cab damper	Original equipment cross-reference	Mounting information
VOLVO continued									
All	FH (380, 400, 420, 440, 460, 480, 500, 520, 540)		CB0207 or CB0205	CB0207 OE# = 21170611 22040662 CB0205 OE# 21170510, 21739591, 23111320, 23111328, 22040653, 23111324	$\perp \oplus$ (CB0207 air / CB0205 exct air)	T5444	CB0175	T5444 OE# = 21243049, 21909826, 23409864 CB0175 OE# = 21739593, 22040665	F5444 = $\perp \oplus$ CB0175 = $\oplus \oplus$
All	FL6		—	—		T5177	—	T5177 OE# = 1079150 20374544 20585555 21172388	T5177 (air susp) = $\oplus \oplus$
All	FL7 & FL10 & FL12	"T5092" or "T1005" or T1149		T5092 OE# = 1609002 T1005 OE# = 1609603 8151707 T1149 OE# = 1094523 20532767 20769819 8159833	$\oplus \oplus$ (Leaf susp = T1005, T1149). (Air susp = T5092)	T5155 or T5177	CB0017	T5155 OE# = 1598106 T5177 OE# = 1079150 20374544 20585555 21172388 CB0017 OE# = 1089728 1593843 1594089	T5155, T5177 (air susp) = $\oplus \oplus$ CB0017 = $\perp \top$
All	FL180, FL220, FL250	"T1180" or T1254	—	T1180 OE# = 3987959 T1254 OE# = 20350040	$\oplus \oplus$	T5177	—	T5177 OE# = 1079150 20374544 20585555 21172388	T5177 (air susp) = $\oplus \oplus$
All	FM, FM2, FM3, FMX, FMX2, FMX3	T1388		T1388 OE# 21866530	$\oplus \oplus$	T5444	—	T5444 OE# = 21243049, 21909826, 23409864	$\perp \oplus$
All	FM7	"T5184"	—	T5184 OE# = 20374546	$\oplus \oplus$	T1360	—	T1360 OE# = 20709798 20883347	T1360 (air) = $\oplus \oplus$
	FM7 Cabin Damper	—	"CB0005" or CB0007	CB0005 OE# = 1075445 CB0007 OE# = 1622227	$\oplus \oplus$	—	—		
All	FM9	"T5184"	—	T5184 OE# = 20374546	$\oplus \oplus$	"T5170" or "T1180" or T1360 or T5177	—	T5170 OE# = 20374543 20585556 T1180 OE# = 3987959 T1360 OE# = 20709798 20883347 T5177 OE# = 1079150 20374544 20585555 21172388	T5170, T1180, T1360 (air susp) = $\oplus \oplus$
	FM9 Cabin Damper	—	CB0007 or CB0055 or CB0040 or CB0004 or "CB0039" or "CB0212"	CB0007 OE#'s = 1622227 3198849 3986315 CB0055 OE#'s = 20399204 20453258 3198837 20453256 20889132 21111932 CB0040 OE# = 3198838 CB0004 OE# = 1076860 20721166 21137458 3172986 3198859 CB0039 OE# 20453256 20453258 20889132 20889136 21111932 21111942 3198837 CB0212 OE# 20453258 20889136 21111942 3198837	CB0007 & CB0004 = $\oplus \oplus$ CB0040 = $\perp \oplus$ (no top rubbers order MK800) CB0039 (coil susp) = $\perp \oplus$ (no top rubbers or- der MK800) CB0055 (airspring) CB0212 (incl air spring)	—	CB0001	CB0001 OE# = 20427897 20721167 20889138 21032337 21651229 3198850	CB0001 = $\oplus \oplus$ (airspring)
All	FM10	—	—	—		T1360	—	T1360 OE# = 20709798 20883347	T1360 (air) = $\oplus \oplus$
All	FM10 Cabin Damper	—	"CB0005" or CB0007	CB0005 OE # = 1075445 and CB0007 OE# = 1622227	$\oplus \oplus$	—	—	—	

Key

*	See important installation information on inside front cover
!	Excluding self-leveling suspension
...	Special order – phone 010 900 1850. 6-12 week waiting period

~	Imported
#	Internal bump stop
\oplus	Steering damper

- It is recommended that all new shock absorbers are fitted in pairs
- Do not mix gas and non-gas units on the same axle
- **Bold** part numbers indicate heavy-duty shocks
- Underlined part numbers indicate parts not immediately available
- *Italic* part numbers followed by > indicate parts to be discontinued
- *13 Check the OE part number on the old shock for the correct application

Truck, bus and trailer

Part number [alphabetical listing]

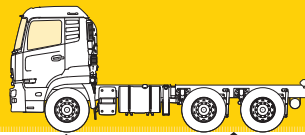

Year	Application	Front				Rear			
		Magnum	Cab damper	Original equipment cross-reference	Mounting information	Magnum	Cab damper	Original equipment cross-reference	Mounting information
VOLVO continued									
ALL	FM12	"T5184"	—	T5184 OE# = 20374544	⊖ ⊖	"T5170" OR "T1180" OR T1360 OR T5177	—	T5170 OE# = 20374543 20585556 T1180 OE# = 3987959 T1360 OE# = 20709798 20883347 T5177 OE# = 1079150 20374544 20585555 21172388	T5170, T1180, T1360, T5177 (air susp) = ⊖ ⊖
	FM12 Cabin Damper	—	"CB0005" OR CB0007 OR CB0055 OR CB0040 CB0004 OR "CB0039" OR "CB0212"	CB0005 OE# = 1075445 and CB0007 OE# = 1622227 CB0040 OE# = 3198838 CB0055 OE# = 20399204 20453256 20889132 21111932 CB0004 OE# = 1076860 20721166 21137458 3172986 3198859 CB0039 OE# 20453256 20453258 20889132 20889136 21111932 21111942 3198837 CB0212 OE# 20453258 20889136 21111942 3198837	CB0005 & CB0007 & CB0004 = ⊖ ⊖ CB004 = ⊥ ⊖ CB0055 (airspring) CB0039 (coil susp) = ⊥ ⊖ (no top rubbers order MK800) CB0212 (incl air spring)	—	CB0001	CB0001 OE# = 20427897 20721167 20889138 21032337 21651229 3198850	CB0001 = ⊖ ⊖ (incl airspring)

VOLVO									
ALL	Volvo B5, B7, B8, B9, Bus	B5434	—	B5434 OE# = 21395046 21468510 70397058 70397060 70397084 70397094	○ T				
ALL	Volvo B10, B12 Bus	B1343 OR B5296	—	B1343 OE# = 20540056 20543860 20568808 3037213 3178737 3178738 B5296 OE# = 20549244 3178737	B1343 INCL Air susp & B5296 = ⊖ ⊖ (Top 16id, Btm 20id)	B1279	—	B1279 OE# = 3031624 3031625 3031626 3031627 3036162 70321696	⊖ ⊖ (Top 16id, Btm 16id) INCL Air susp
ALL	Volvo B11, B13 Bus	B5434	—	B5434 OE# = 21395046 21468510 70397058 70397060 70397084 70397094	○ T				

Key

*	See important installation information on inside front cover
!	Excluding self-levelling suspension
"..."	Special order – phone 010 900 1850. 6-12 week waiting period

~	Imported
#	Internal bump stop
⊖	Steering damper

- It is recommended that all new shock absorbers are fitted in pairs
- Do not mix gas and non-gas units on the same axle
- **Bold** part numbers indicate heavy-duty shocks
- Underlined part numbers indicate parts not immediately available
- *Italic* part numbers followed by > indicate parts to be discontinued
- *13 Check the OE part number on the old shock for the correct application

Seat dampers

Part number [numerical listing]



ISRI	Monroe® AM
0461-742-6688	"SD0006"
26960-01	"SD0003"
26960-03	"SD0003"
31141-02	"SD0006"
31141-03	"SD0007"
31141-04	"SD0002"
31141-05	"SD0007"
31141-06	"SD0006"
31141-12	"SD0007"
31141-22	"SD0002"
31141-33	"SD0002"
31141-42	"SD0002"
31141-44	"SD0002"
31141-54	"SD0002"
31141-56	"SD0002"
31141-69	"SD0002"
31141-76	"SD0002"
31141-78	"SD0006"
31141-87	"SD0002"
31141-99	"SD0002"
31166-01	"SD0006"
31166-74	"SD0006"
33144-01	"SD0002"
33144-33	"SD0002"
33144-36	"SD0002"
33144-44	"SD0002"
33144-49	"SD0002"
33144-54	"SD0002"
33144-56	"SD0002"
33144-99	"SD0002"
33734-01	"SD0004"
33734-03	"SD0004"
33734-55	"SD0005"
33734-99	"SD0004"
34042	"SD0001"
34125	"SD0006"
35912	"SD0001"
35912-01	"SD0001"

Monroe® OE	Monroe® AM
62308	"SD0006"
62320	"SD0002"
62325	"SD0002"
62329	"SD0002"
62338	"SD0007"
62340	"SD0006"
62344	"SD0002"
62346	"SD0002"
62358	"SD0002"
62363	"SD0002"
62373	"SD0002"
62423	"SD0002"
62424	"SD0002"
62428	"SD0002"
62431	"SD0002"
62458	"SD0002"
62460	"SD0005"
62465	"SD0001"
62466	"SD0004"
62469	"SD0007"
62472	"SD0002"
62473	"SD0002"
62474	"SD0002"
62478	"SD0006"
62479	"SD0004"
62480	"SD0002"
62481	"SD0006"
62482	"SD0002"
62483	"SD0002"
62484	"SD0006"
62490	"SD0002"
62491	"SD0002"
62492	"SD0007"
62493	"SD0006"
62494	"SD0002"
62495	"SD0002"
62496	"SD0002"
62497	"SD0002"
62498	"SD0002"
62499	"SD0002"
62500	"SD0002"
62501	"SD0006"
62502	"SD0006"
62503	"SD0006"

Monroe® AM	Monroe® OE	ISRI
"SD0001"	62465	34042
"SD0001"	62521	34042
"SD0001"	62569	35912
"SD0001"	62589	35912-01
"SD0001"	62616	35912-01
"SD0001"	62628	35912
"SD0001"	62642	35912-01
"SD0002"	62320	31141-99
"SD0002"	62325	31141-56
"SD0002"	62329	31141-87
"SD0002"	62346	31141-76
"SD0002"	62358	31141-42
"SD0002"	62363	31141-33
"SD0002"	62373	31141-42
"SD0002"	62423	33144-33
"SD0002"	62424	33144-54
"SD0002"	62428	31141-69
"SD0002"	62431	33144-36
"SD0002"	62344	31141-44
"SD0002"	62458	33144-56
"SD0002"	62472	33144-01
"SD0002"	62473	33144-44
"SD0002"	62474	33144-49
"SD0002"	62480	31141-56
"SD0002"	62482	31141-69
"SD0002"	62483	31141-54
"SD0002"	62490	31141-99
"SD0002"	62491	31141-56
"SD0002"	62494	31141-44
"SD0002"	62495	31141-76
"SD0002"	62496	31141-22
"SD0002"	62497	31141-33
"SD0002"	62498	31141-42
"SD0002"	62499	31141-69
"SD0002"	62500	31141-54
"SD0002"	62509	33144-33
"SD0002"	62510	33144-54
"SD0002"	62511	33144-36
"SD0002"	62512	33144-56
"SD0002"	62513	33144-01
"SD0002"	62514	33144-44
"SD0002"	62515	33144-49
"SD0002"	62529	31141-04
"SD0002"	62772	33144-99

Key

*	See important installation information on inside front cover
!	Excluding self-levelling suspension
"..."	Special order – phone 010 900 1850. 6-12 week waiting period

~	Imported
#	Internal bump stop
⊕	Steering damper

- It is recommended that all new shock absorbers are fitted in pairs
- Do not mix gas and non-gas units on the same axle
- **Bold** part numbers indicate heavy-duty shocks
- Underlined part numbers indicate parts not immediately available
- *Italic* part numbers followed by > indicate parts to be discontinued

Seat dampers

Part number [numerical listing]



Monroe® OE	Monroe® AM
62509	"SD0002"
62510	"SD0002"
62511	"SD0002"
62512	"SD0002"
62513	"SD0002"
62514	"SD0002"
62515	"SD0002"
62516	"SD0006"
62521	"SD0001"
62529	"SD0002"
62569	"SD0001"
62589	"SD0001"
62612	"SD0007"
62613	"SD0007"
62616	"SD0001"
62628	"SD0001"
62636	"SD0006"
62642	"SD0001"
62658	"SD0004"
62728	"SD0003"
62742	"SD0003"
62772	"SD0002"
62804	"SD0006"

Monroe® AM	Monroe® OE	ISRI
"SD0003"	62728	26960-03
"SD0003"	62742	26960-01
"SD0004"	62466	33734-01
"SD0004"	62479	33734-99
"SD0004"	62658	33734-03
"SD0005"	62460	33734-55
"SD0006"	62308	31166-01
"SD0006"	62340	31141-78
"SD0006"	62478	34125
"SD0006"	62481	31141-78
"SD0006"	62484	31141-02
"SD0006"	62493	31141-78
"SD0006"	62501	31141-02
"SD0006"	62502	31166-01
"SD0006"	62503	31166-74
"SD0006"	62516	34125
"SD0006"	62636	0461-742-6688
"SD0006"	62804	31141-06
"SD0007"	62338	31141-12
"SD0007"	62469	31141-12
"SD0007"	62492	31141-12
"SD0007"	62612	31141-03
"SD0007"	62613	31141-05

Key

*	See important installation information on inside front cover
!	Excluding self-levelling suspension
"..."	Special order – phone 010 900 1850. 6-12 week waiting period

~	Imported
#	Internal bump stop
⊕	Steering damper

- It is recommended that all new shock absorbers are fitted in pairs
- Do not mix gas and non-gas units on the same axle
- **Bold** part numbers indicate heavy-duty shocks
- Underlined part numbers indicate parts not immediately available
- *Italic* part numbers followed by > indicate parts to be discontinued

Maxlift

Part number [alphabetical listing]

Year	Application	Front		Rear	
		Part number	Info	Part number	Info
ALFA ROMEO					
147					
June'01-10	147 1.6TS, 1.9JTD & 2.0TS hatch	Bonnet "ML5696"		Hatch "ML5222"	
Alfetta, Giulietta					
10-20	Giulietta (940)	Bonnet "ML6191"		Boot "ML6190"	
MiTo					
09-18	MiTo hatch 1.4, 1.4T, 1.6JTD			Hatch "ML5655"	
AUDI					
Audi 80 / 100 / 500					
92-'01	80 / 100 / 500 Cabriolet	Bonnet ML0597	OE# = 8A0 823 360 A	—	
A1					
11-May 18	A1 (8X) gen 1	Bonnet ML6154		Hatch ML6153	
June 18-on	A1 (GB) gen 2				
A3					
98-April'03	A3 (8L1) gen 1	Bonnet ML2485	ML2485 = OE# 8L0823359B, OE#-1J0823359A/B/C/D, 1J0827359A/B	Hatch tailgate = ML2577 or ML2535	Hatch tailgate ML2577 = OE # 820 827 552 A/B / 8D9 827 552, or ML2535 = OE# 8D9 827 552 F
May'03-12	A3 (8P1) gen 2	Bonnet ML0326	ML0326 = OE# 8P0823359	Hatch ML2679 or ML2055	Hatch ML2679 spoiler or Sportback Hatch ML2055
May'12-20	A3 (8V) gen 3	Bonnet ML0243	ML0243 = OE# 8V0823359	Hatch ML1960	
20-on	A3 (8Y) gen 4				
A3					
08-13	A3 Cabriolet	Bonnet ML0326	ML0326 = OE# 8P0823359	—	
A4					
95- Jan'99	A4 Sedan 8D, B5	Bonnet ML0597 or ML0265	ML0597 = OE# 8A0 823 360 A or ML0265 = OE# 3B0 823 359 A/B/C/D/E or 8D0 823 354 or 8D0 823 359 A/B	Boot ML4149	ML4149 = OE# 8D5 827 552 C/F or 3B5 827 550 A/E or 8D5 827 552 A/B/C/D/F or 8N0 823 359
96- Jan'99	A4 Avant 8D, B5	Bonnet ML0597 or ML0265	ML0597 = OE# 8A0 823 360 A or ML0265 = OE# 3B0 823 359 A/B/C/D/E or 8D0 823 354 or 8D0 823 359 A/B	—	
Feb'99-Nov'00	A4 Sedan : Avant S/Wagon) B5, 8D	Bonnet ML0597 or ML0265	ML0597 = OE# 8A0 823 360 A or ML0265 = OE# 3B0 823 359 A/B/C/D/E or 8D0 823 354 or 8D0 823 359 A/B	Boot = ML4149	ML4149 OE# = 8D5 827 552 C/F or 3B5 827 550 A/E or 8D5 827 552 A/B/C/D/F or 8N0 823 359
Feb'99-Nov'00	A4 Avant : Sedan) B5, 8D	Bonnet ML0597 or ML0265	ML0597 = OE# 8A0 823 360 A or ML0265 = OE# 3B0 823 359 A/B/C/D/E or 8D0 823 354 or 8D0 823 359 A/B	—	
Dec'00- 04	+ A4 Sedan & Avant B6, 8E	Bonnet ML0289		Tailgate ML2417 or Boot ML3995	S/Wagon Tailgate ML2417 or Boot ML3995
05-07	+ A4 & Avant Cabriolet boot) B7	Bonnet ML0289		Boot ML4003	
08-Jan 16	+ A4 Sedan & Avant (B8)	Bonnet ML0202	Bonnet ML0202 = OE# 87082335902S	Tailgate ML2386 Power Tailgate ML2590 Boot ML3304	S/Wagon Tailgate ML2386 = OE# 8K9827552 Power Tailgate = OE# 8K9827552
Feb 16-on	A4 Sedan (B9, 8W)	Bonnet ML6440			
A5					
08-Jan 16	A5 Coupe & Cabriolet (B1)	Bonnet ML0202	Bonnet ML0202 = OE# 87082335902S	Boot ML3820 Tailgate ML2822 (Sportback)	
Feb 16-on	A5 Coupe & Cabriolet (B9)	Bonnet ML6440			
A6					
97-Jan'99	A6 Sedan & Avant	Bonnet ML0299		—	
Feb'99-April'00	A6 Sedan & Avant	Bonnet ML0299		—	
May'00-March'04	A6 Sedan & Avant	Bonnet ML0299		—	
July 04-11	A6 Sedan & Avant (C6)	Bonnet "ML5737"		Boot elec) "ML5744" / Boot (elec) "ML6104" / Tailgate "ML5746"	ML5744 elec ML6104 (auto close)
11-19	A6 Sedan & Avant (C7)	Bonnet "ML6193"		Tailgate elec) "ML6226" / Tailgate (elec) "ML6192"	ML6226 elec) ML6192 (elec)

Key

*	See important installation information on inside front cover
!	Excluding self-levelling suspension
"..."	Special order - phone 010 900 1850. 6-12 week waiting period

~	Imported
#	Internal bump stop
⊕	Steering damper

- It is recommended that all new shock absorbers are fitted in pairs
- Do not mix gas and non-gas units on the same axle
- **Bold** part numbers indicate heavy-duty shocks
- Underlined part numbers indicate parts not immediately available
- *Italic* part numbers followed by > indicate parts to be discontinued

Maxlift

Part number [alphabetical listing]

Year	Application	Front		Rear	
		Part number	Info	Part number	Info
AUDI continued					
20-on	A6 Sedan & Avant (C8)	–		–	
A7 					
11-18	A7 Sportback (4GA, 4GF)	Bonnet ML3786	OE# 468823359A	–	
18-on	A7 Sportback (4KA)			–	
Q2 					
17-23	Q2 (GAB, GAG)				
Q3 					
11-18	Q3 2x4 & 4x4 (8U)	Bonnet ML6156		Hatch ML6157	
18-on	Q3 2x4 & 4x4 (F3)				
Q5 					
08-17	Q5 4x4 (8R)	Bonnet ML3914		Tailgate ML2622 / Power Tailgate ML2624	ML2622 OE# 8R0827552 / 8R0827552B ML2624 OE# 8R0827552A
18-on	Q5 4x4 (FY)				
Q7 					
06-15	Q7 4x4 (4L)	Bonnet ML2771		Power Tailgate ML2467 / Tailgate "ML5929"	"ML5929" OE#s = 689500W200 / 689500W201 / 689500W202 / 689500W203
15-on	Q7 4x4 (4M)	Bonnet ML0283		Tailgate ML1799	
TT 					
00-06	TT (BN)	Bonnet "ML5135"		–	
07-15	TT (8J)	Bonnet "ML5740"		Hatch ML2912 >	
15-on	TT (FV)	Bonnet ML3624			

BMW					
1 Series					
E81 (3 door), E87 (5 door) 					
End 04-Oct'11	1 Series	Bonnet ML3556		Hatch ML3387	
F20 (5 door), F21 (3 door) 					
Nov'11-19	1 Series	Bonnet ML4076		Hatch ML2992	
F40 1 Series					
Nov'19-on	1 Series				
2 Series					
F22  , F23 					
Nov'14-on	2 Series Coupe, Cabriolet	Bonnet ML4076		–	
F45, F46 					
Nov'14-16	2 Series Active Tourer MPV	Bonnet "ML6355"			
3 Series					
E30   					
84-91	All 3 Series (E30)	Bonnet ML4257		–	
E36 					
91-99	316i, 318i, 318is, 318tds, 320i, 323i, 325i, 325td, 325tds, 328i Imported & Local Strut.  Cabrio.  M3. (E36)	Bonnet ML3657		Boot ML4037	
E36  					
93-99	 M3 (E36)	–		Boot ML4037	
93-99	 323i, 325i & 328i Cabriolet  M Tech) (E36)	Bonnet "ML5421"		Boot ML4037	(not lid cover)
E46 					
99 - Feb'05	All 3 Series (E46)  S/Wagon, Compact hatch, M3, cabrio, coupe, & sport susp)	Bonnet ML3865		Boot ML3733	
E46 Compact 					
Nov'01-05	All 3 Series Compact (E46)  sedan)	Bonnet ML3865		Hatch tailgate ML0795	
E46 					
00-05	3 Series Touring (E46)	Bonnet ML3865		Tailgate "ML5213"	

Key

































*	See important installation information on inside front cover
!	Excluding self-levelling suspension
"..."	Special order - phone 010 900 1850. 6-12 week waiting period

~	Imported
#	Internal bump stop
⊕	Steering damper

- It is recommended that all new shock absorbers are fitted in pairs
- Do not mix gas and non-gas units on the same axle
- **Bold** part numbers indicate heavy-duty shocks
- Underlined part numbers indicate parts not immediately available
- *Italic* part numbers followed by > indicate parts to be discontinued

Maxlift

Part number [alphabetical listing]

Year	Application	Front		Rear	
		Part number	Info	Part number	Info
BMW continued					
3 Series continued					
E46 					
00-06	 330Ci Cabriolet  Sport Pac II & M3) (E46)	Bonnet ML3865		Roof "ML3610" or "ML3611"	ML3610 OE# = 1002092 length 285mm or ML3611 OE# = 54318268980 length 205mm
99-06	 325Ci, 330Ci Coupe  Sport Pac II & M3) (E46)	Bonnet ML3865		Boot ML3733	
E90 					
March 05-12	3 series (E90) 320i, 320d, 323i, 325i, 330d & 330i  M3, Cabrio & Coupe)	05-'11 Bonnet ML3475 / '12-'14 Bonnet ML4128		Boot ML3579	
E92  E93 					
07-12	 330i, 335i Cabriolet  M3, Coupe & sedan) (E93)	05-'11 Bonnet ML3475 / '12-'14 Bonnet ML4128		—	
07-12	 320i, 325i, 335i Coupe  M3, Cabrio & Sedan) (E92)	05-'11 Bonnet ML3475 / '12-'14 Bonnet ML4128		Boot "ML5689"	
F30 					
13-18	3 series (F30) sedan	Bonnet ML4076		Boot ML3320	OE# 51247259763
F34 GT 					
13-on	3 series (F34) Grand Turismo 5 door Liftback / hatch	Bonnet ML4076			
G20 					
March 19-on	3 Series (G20) sedan Gen 7				
4 Series					
F32  , F33 (CB, F36 					
13-on	4 Series Coupe, Cabriolet, Gran Coupe (liftback)	Bonnet ML4076		Boot "ML6351"	F32 Coupe = ML6351 (Poland)
5 Series					
E39 					
96-'03	5 Series (E39)  M5, M Tech & S/Wagon)	Bonnet "ML5336"		Boot "ML5590"	
E60 					
Nov'03- May'10	All E60 5 Series sedan  Touring S/Wagon, M5)	Bonnet "ML5562"		—	
E61 					
04-'10	All E61 5 Series Touring S/Wagon	Bonnet "ML5562"		—	
F10  F07 					
June'10-16	F10 5 Series sedan  Touring S/Wagon)	Bonnet "ML6333"	OE# 51237207188 for active bonnet (Poland)	—	
June'10-16	F07 5 Series GT Liftback  Touring S/Wagon)	—		—	
G30 					
16-on	G30 5 Series sedan			—	
7 Series 					
E23					
78-87	7 Series (E23)	—		—	
E32 					
88-94	7 Series (E32)  M Tech)	Bonnet ML4257		Boot "ML5934"	
E38 					
94-02	7 Series (E38)	—		Boot "ML5523"	
E65 					
Mid 02- Feb'09	730d, 735i, 740i, 745i, 750i (E65)	Bonnet "ML5565"		—	
F01 					
09-16	7 Series (F01)	—		—	

Key

*	See important installation information on inside front cover
!	Excluding self-levelling suspension
...	Special order – phone 010 900 1850. 6-12 week waiting period

~	Imported
#	Internal bump stop
⊕	Steering damper

- It is recommended that all new shock absorbers are fitted in pairs
- Do not mix gas and non-gas units on the same axle
- **Bold** part numbers indicate heavy-duty shocks
- Underlined part numbers indicate parts not immediately available
- *Italic* part numbers followed by > indicate parts to be discontinued

Maxlift

Part number [alphabetical listing]

Year	Application	Front		Rear	
		Part number	Info	Part number	Info
BMW <i>continued</i>					
7 Series <i>continued</i>					
G11					
16-April '22	7 Series (G11)	–		–	
G11					
May 22-on	7 Series (G70)	–		–	
X1 E84					
10-Oct 15	X1 SUV gen 1	Bonnet ML3756	OE# 41612990344	Tailgate ML1551	
X1 F48					
Nov 15-Oct 22	X1 SUV gen 2	Bonnet ML3208	OE# 51237329410		
X1 U11					
Nov 22-on	X1 SUV gen 3				
X3 E83					
04-10	X3 SUV	Bonnet ML4075		Tailgate ML0855	
X3 F25					
11-17	X3 SUV	Bonnet ML3999		Tailgate (manual) ML0686	OE# 51247211289
X3 G01					
18-on	X3 SUV				
X4 (F26)					
14-Sept 18					
X4 (G02)					
Oct 18-on					
X5 E53					
01-06	X5	Bonnet ML4063		Tailgate ML2075	<u>ML</u> glass
X5 E70					
07-13	X5	Bonnet ML3386		–	
X5 F15					
13-18	X5	Bonnet ML3610		–	
X5 G05					
18-on	X5			–	
X6 E71					
09-Jan 15	X6 Cross-over vehicle	Bonnet ML3386		–	
X6 F16					
Feb 15-on	X6 Cross-over vehicle	Bonnet ML3610		–	
Z3 E36/8 E36/7					
97-'03	Z3 (E36, E37 E38)	–		Boot "ML5780"	
Z4 E86 E85					
04-09	Z4 (E85)	–		E85 Cabrio Boot "ML5861"	
Z4 E89					
09-16	Z4 (E89)	–		–	
Z4 G29					
18-on	Z4 (G29)				
CHEVROLET (Also see Opel)					
Ascona					
82-85	Ascona	–		Boot ML2725 >	
Aveo					
03-11	Aveo T200 & T250 (gen one)	–		Tailgate ML3511	
11-on	Aveo (gen two)	–		Tailgate ML2778	

Key







*	See important installation information on inside front cover
!	Excluding self-levelling suspension
"..."	Special order – phone 010 900 1850. 6-12 week waiting period





~	Imported
#	Internal bump stop
⊕	Steering damper

- It is recommended that all new shock absorbers are fitted in pairs
- Do not mix gas and non-gas units on the same axle
- **Bold** part numbers indicate heavy-duty shocks
- Underlined part numbers indicate parts not immediately available
- *Italic* part numbers followed by > indicate parts to be discontinued







Maxlift

Part number [alphabetical listing]

Year	Application	Front		Rear	
		Part number	Info	Part number	Info
CHEVROLET <i>continued</i>					
Captiva 					
07-March '11	Captiva SUV (C100)	Bonnet ML3318		Tailgate ML1398	ML1398 OE# = 868014611398
April '11-18	Captiva SUV (T300)	Bonnet ML3318		Tailgate ML1398 or ML2694 (around 2013)	ML1398 (open 583mm) OE# = 868014611398 or 96830123 or 20880956 or 20913311 ML2694 (open 495mm) = OE# = 868014612694 or 95494360 or 95047796
Cruze 					
12-16	Cruze J300 (gen two) Hatch 1.6 & 1.8	—		—	
Orlando 					
11-on	Orlando J309 MPV	—		Tailgate ML3158	OE# 95985321or 95985322
Sonic 					
11-on	Sonic hatch T300	—		Hatch ML2778	
Spark 					
03-05	Spark (M100, M150)	—		Hatch ML2681	
05-July '10	Spark (M200, M250)  Lite 2010-on	—		Hatch ML3410	
Aug '10-on	Spark LITE (M200, M250)	—		Hatch ML3410	
Aug '10-on	Spark (M300)	—		Hatch ML3546	
Trailblazer 					
12-18	Trailblazer SUV	—		—	

CHRYSLER					
PT Cruiser  					
01-10	PT Cruiser  cabriolet)	—		Tailgate ML1393 >	
Voyager 					
95-00	Voyager 2.0 SWB & Grand Voyager 3.3 V6 & 2.5 TD LWB	—		Tailgate ML0505 >	
01-07	Voyager 2.0 & 2.4 SWB; & Grand Voyager 2.8, 3.3 V6 & 2.5TD LWB	—		Tailgate "ML6195"	
08-10	All Voyager; and Grand Voyager	—		—	
11-14	All Voyager; and Grand Voyager	—		—	

For Jeep ... see Jeep

CITROEN					
BERLINGO 					
08-18	Berlingo 4 van (B9)	—		Tailgate "ML5948" Rear Glass "ML5954" & "ML5956"	ML5948 (length 620mm) OE#s 8731S0 ML5954 (length 543mm) OE#s 8731R9, 8731V6 ML5956 (length 563mm) OE# 8731R8
C1 					
08-14	C1	—		Hatch ML1735	
C2 					
04-11	C2	—		Hatch ML3040	
C3 					
02-May '06	C3	—		—	
June '06-Nov '09	C3	—		Hatch ML2868	
Dec '09-16	C3	—		Hatch ML2868	
C3 					
10-13	C3 Picasso	—		Tailgate "ML5862"	
C4  					
05-10	C4 1.6i, 2.0i gen 1	—		ML1920	
10-16	C4 1.6i, 2.0i gen 2	—		ML2390	

Key





















*	See important installation information on inside front cover
!	Excluding self-levelling suspension
"..."	Special order - phone 010 900 1850. 6-12 week waiting period

~	Imported
#	Internal bump stop
⊕	Steering damper

- It is recommended that all new shock absorbers are fitted in pairs
- Do not mix gas and non-gas units on the same axle
- **Bold** part numbers indicate heavy-duty shocks
- Underlined part numbers indicate parts not immediately available
- *Italic* part numbers followed by > indicate parts to be discontinued

Maxlift

Part number [alphabetical listing]

Year	Application	Front		Rear	
		Part number	Info	Part number	Info
CITROEN <i>continued</i>					
C4 					
08-13	C4 Picasso MPV	–		Tailgate "ML5755" or "ML5756"	ML5755 = Hinged rear window / ML5756 Fixed rear window
13-18	C4 Picasso MPV	–		Tailgate "ML5783" / Tailgate "ML5755"	(Poland) / ML5783 no opening window / ML5755 with opening window
C4 Aircross 					
13-17	C4 Aircross	–		–	
C4 Cactus 					
13-17	C4 Cactus	–		Tailgate "ML6352"	OE = 9800805480, 9813913880
DS3 					
11-18	DS3 1.6i	–		Hatch ML3362 >	
DS4 					
11-16	DS4	–		Hatch "ML6164"	OE = 9676672180
DS5 					
12-16	DS5	Bonnet "ML6431"	OE = 9686809680	Hatch "ML6420"	OE = 9686809480
DAEWOO					
Matiz 					
99-03	Matiz hatch M100	–		Hatch ML2681	
DAIHATSU					
Sirion 					
98- Feb'05	Sirion hatch M100 / M101	–		–	
March '05-10	Sirion 1.3 & 1.5 hatch M300	–		Hatch Tailgate "M6084"	
11-16	Sirion 1.3 & 1.5 hatch Gen 2	–		–	
Terios 					
98-May'06	Terios 4x4 J102G Gen 1	–		–	
June'06-17	Terios 4x2 & 4x4 J200, J210, J211 Gen 2	–		–	
DATSUN					
Go 					
15-18	Go & Go+ hatch	–		–	
FIAT - PASSENGER					
500 					
08-on	500  500L	–		Hatch ML3068	
500L 					
14-18	500L  std 500	Hatch "ML6281"		Hatch "ML6276" or "ML6277"	ML6276 OE# 51895435 or ML6277 OE# 51883050, 51953757
Bravo 					
07-on	Bravo (198 generation II) 1.4, 1.9  sport susp)	–		Hatch "ML5784"	
Croma 					
06-09	Croma (generation II)	–		S/Wagon Tailgate "ML5795"	
Doblo 					
03-10	Doblo Cargo panel Van (223)	–		Tailgate "ML5448"	
10-on	Doblo Cargo panel Van (263)	–		Tailgate "ML6201"	
Multipla 					
03-10	Multipla MPV 1.6, 1.9JTD  Bi-power)	Bonnet "ML4421"	OE# = 46559850, 46559858	Tailgate ML2349 > "ML5377"	OE# = 46514867
Palio 					
00-03	Palio hatch Type 1X MkI	–		Hatch Tailgate ML2841	
03-10	Palio II hatch Type 2H MkIV	–		Hatch Tailgate ML2841	

Key

*	See important installation information on inside front cover
!	Excluding self-levelling suspension
"..."	Special order – phone 010 900 1850. 6-12 week waiting period

~	Imported
#	Internal bump stop
⊕	Steering damper

- It is recommended that all new shock absorbers are fitted in pairs
- Do not mix gas and non-gas units on the same axle
- **Bold** part numbers indicate heavy-duty shocks
- Underlined part numbers indicate parts not immediately available
- *Italic* part numbers followed by > indicate parts to be discontinued

Maxlift

Part number [alphabetical listing]

Year	Application	Front		Rear	
		Part number	Info	Part number	Info
FIAT - PASSENGER continued					
Palio					
00-02	Palio Weekend S/Wagon Type PY & 1Y	—		S/Wagon Tailgate ML1361 >	
02-10	Palio II Weekend S/Wagon Type 2G & 2K	—		S/Wagon Tailgate ML1361 >	
Palio					
01-10	Palio Expresso panel Van	—		Hatch Tailgate ML2841	
Panda					
04-on	Panda (169) 1.2, 1.3 (EXI) AWD & 1.4 100HP)	—		Hatch "ML5101"	
04-10	Panda (169) 1.3 Climbing AWD	—		Hatch "ML5101"	
11-on	Panda (312) 1.2 (EXI) AWD & 1.4 100HP)	—		Hatch "ML6372"	
Punto					
04-Feb'12	Punto 1.2, 1.3 JTD, 1.4 Hatch (MkII) (188)	—		Hatch ML3077	5 door
04-10	Punto 1.8 HGT 1.6v 3 door Hatch, plus 1.4 Sport Susp (MkII) (188)	—		Hatch "ML5164"	3 door
March '12-16	Punto 1.2, 1.3 JTD, 1.4 Hatch (188 facelift)	—		Hatch ML3077	5 door
Grand Punto					
06-16	Grand Punto 1.2, 1.3, 1.4 & 1.9 (199)	—		Hatch "ML5775"	
Seicento					
Sept'01-06	Seicento 1100 (187)	—		Hatch "ML5081"	
Stilo					
03-10	Stilo Hatch (192) (Check OE #'s, length & pressure before ordering)	—		Hatch "ML5038" or "ML5280" or "ML5281"	ML5038 length 500mm @ 280N ML5280 length 442mm @ 460N ML5281 length 506mm @ 380N
Stilo					
03-10	Stilo Multi Wagon (192)	—		Special order available	5 different options – check OE#'s before ordering
Uno					
90-'06	Uno All	—		Hatch Tailgate ML1625	
07-09	Uno (EXI) raised body "Way" version)	—		Hatch Tailgate ML1625	
FORD					
Ecosport					
13-on	Ecosport SUV	—		Rear door ML2423	OE# CN15N400A12AB
Escort					
Mid 81-86	Escort FWD	—		Hatch tailgate ML1485 >	OE #' = 81ABB406A10BB or GA or BA or 1640342 or 4 or 6079115
95-99	Escort FWD (EXI) estate S/Wagon)	—		Hatch tailgate ML2029	
Fiesta					
97 -03	Fiesta Mk4 (EXI) facelift (JA, JB)	—		Hatch ML1413	ML1413 = OE# 96FBB406A10 / BA & 1141159 / AB
04-Oct'08	Fiesta Hatch Mk 5 JH, JD 5 door (EXI) 2.5 ST & 3 door)	—		Hatch ML5207	
04-Oct'08	Fiesta Hatch Mk 5 JH, JD 3 door 2.5 ST (EXI) 5 door)	—		Hatch "ML5205"	
Nov'08-17	Fiesta Hatch Mk 6 (EXI) 2.5 ST)	—		Hatch ML5651	
Nov 18-22	Fiesta Hatch Mk 7	—			
Figo					
10-15	Figo Hatch gen 1	—		Hatch ML5207	
15-on	Figo Hatch gen 2	—		Hatch ML5651	
Focus I					
00-Oct'04	Focus Hatch MkI	—		Hatch ML2989	
Focus II					
Nov'04-July'11	Focus Hatch & Sedan MkII	—		Hatch ML2807 / Boot "ML5786"	

Key

*	See important installation information on inside front cover
!	Excluding self-levelling suspension
"..."	Special order – phone 010 900 1850. 6-12 week waiting period

~	Imported
#	Internal bump stop
⊕	Steering damper

- It is recommended that all new shock absorbers are fitted in pairs
- Do not mix gas and non-gas units on the same axle
- **Bold** part numbers indicate heavy-duty shocks
- Underlined part numbers indicate parts not immediately available
- *Italic* part numbers followed by > indicate parts to be discontinued

Maxlift

Part number [alphabetical listing]

Year	Application	Front		Rear	
		Part number	Info	Part number	Info
FORD <i>continued</i>					
Focus III 🚗 🚗					
Aug'11-18	Focus Hatch & Sedan MkIII	–		Hatch ML1135 / Boot ML2726 ('11-'14) & ML2726 ('15-18)	
Focus IV 🚗 🚗					
18-22	Focus Hatch & Sedan MkIV	–			
Ka 🚗					
05-09	Ka 1.3 Hatch	–		Hatch "ML5136"	
09-10	Ka 1.3 Hatch	–		Hatch "ML5977"	
Kuga 🚗					
11-12	Kuga SUV (I)			Hatch "ML5654" / Rear glass "ML5650"	
13-19	Kuga SUV (II)			Hatch ML0200 ⚡ ML0282 ⚡	500 power tailgate / ML0200 OE# = CV44S406A11AB and ML0282 OE# = CJ5Z78406A10B or CV44S406A10AB
19-on	Kuga SUV (III)				
Mondeo 🚗					
98-01	Mondeo sedan mkII			Boot "ML5290"	OE# = 93BBA406A10AD or 93BBA406A10AE
Sierra / Sapphire 🚗 🚗					
Mid 83-93	Sierra & Sapphire Sedan EXC1 XR8 EXC1 S/Wagon	–		Hatch Tailgate & Boot ML2725 >	
Telstar 🚗 🚗					
93-99	Telstar sedan and TX5 notchback			Hatch & Boot ML2687 > ⚡ & ML2690 > ⚡	
Territory 🚗					
05-09	Territory 4x2 & 4x4 SUV (SX, SY & SY1)	–		Tailgate ML1396 >	
Tourneo & Transit Connect 🚗 🚐					
13-23	Tourneo & Transit Connect			Tailgate "ML6297" (EXC1 rear window) or "ML6298" (with rear window)	ML6297 OE# 1786752, BK21V406A10AB ML6298 OE# 1786750, BK21V406A10BB

HONDA					
Ballade / Civic 🚗 🚗					
89-91	Ballade Hatch Mk4 SH4 / EF / EC / ED	–		Hatch Tailgate "ML5567"	3 Door
92-95	Ballade Hatch & Sedan Mk5 SR4, EH / EG	–		Hatch Tailgate ML2985 / Boot ML3985	ML2985 = OE# 74820SR3003 ML3985 = OE# 74820SR4003
96-March'01	Ballade & Civic (EXC1 Vtec) (EJ9, EK1, EK3, EK4) Mk6	–		Hatch Tailgate ML2231 or ML0813 ⚡ ML0817 ⚡ (Check OE#'s)	ML2231 OE# = 74820ST3E01 / 02, 74820ST3E51 / ...52 / ...53 ML0813 OE# = 04741S00A00 / ...01, 04741S03000 / ...901 ML0817 OE# = 04746S00A00 / ...01, 04746S03000 / ...901
March '01-05	Civic Vtec 5 door hatch (EP, EU) Mk7	–		Hatch Tailgate ML2378	OE# 74820S6DE01 or ..02
06-Aug 16	CivicHatch Mk8 (FN, FK)	–		5 door Hatch ML2378 or "ML6395" / 3 door Hatch ML0682	ML2378 Open = 502mm 400N OE# 74820S6DE01 or ..02 . Or "ML6395" Open = 597mm 465N OE# 74820TV0E011M1, 74820TV0E111M1 / ML0682 Open = 605mm 465N OE# 74820SMGE01 / 74820SMGE02 / 74820SMGE03 / 74820SMTE01 / 74820SMTE02
Sept 16 - on	Civic Hatch Mk8 (FC, FK)	–		Hatch Tailgate ML1674	OE# 74820TG6305
Ballade (City) 🚗					
11-on	Ballade 5th Gen (GM2, GM3)	–		–	–
Brio 🚗					
12-on	Brio hatch	–		–	–
CR-V 🚗					
Jan'98 - 02	CR-V 4x4 2.0 gen 1 (RD 1)	–		Tailgate ML1989	
02-06	CR-V 4x4 2.0, 2.2 gen 2 (RD)	–		Glass ML3719 > "ML5910" Tailgate ML1727	
07-12	CR-V 4x4 gen 3 (RE)	–		Tailgate ML0830	
13-16	CR-V 4x4 gen 4 (RM)	–		Tailgate ML1115	

Key

*	See important installation information on inside front cover
!	Excluding self-levelling suspension
"..."	Special order - phone 010 900 1850. 6-12 week waiting period

~	Imported
#	Internal bump stop
⊕	Steering damper

- It is recommended that all new shock absorbers are fitted in pairs
- Do not mix gas and non-gas units on the same axle
- **Bold** part numbers indicate heavy-duty shocks
- Underlined part numbers indicate parts not immediately available
- *Italic* part numbers followed by > indicate parts to be discontinued

Maxlift

Part number [alphabetical listing]

Year	Application	Front		Rear	
		Part number	Info	Part number	Info
HONDA continued					
CR-V  continued					
17-23	CR-V 4x4 gen 5 (RW)	—		Tailgate ML0279	OE# 74820TLAA01 or 74870TLAA01
23-on	CR-V 4x4 gen 6 (RS)	—		—	
Jazz / Fit 					
03-04	Jazz gen 1 (GD)	—		Hatch ML5911	
05-07	Jazz gen 1 (GD facelift)	—		Hatch ML5911	
08-15	Jazz gen 2 (GE)	—		Hatch ML3248	
15-May 21	Jazz gen 3 (GK)	—		Hatch ML6450	OE# : 74820T5RA01, 74870T5RA01
July 21-on	Fit gen 4 (GR, GS)	—			
HUMMER					
H3 					
05-11	H3	Bonnet ML3566 >		—	
HYUNDAI					
Accent 					
94-May'97	Accent I sedan (X3)	—		Hatch Tailgate ML2017 >	
June'97-June'00	Accent I sedan (X3) facelift	—		Hatch Tailgate ML2017 >	
July'00-05	Accent II sedan (LC)	—		—	
06-early July'11	Accent III Sedan & Hatch (MC)	—		Hatch Tailgate ML2011 >	OE#s 817701E000 or 817801E000
Aug'11-19	Accent IV Sedan & Hatch (RB)	—		—	
Atos 					
00-08	Atos Prime  earlier Atos	—		Hatch Tailgate ML3123  & ML3124   or ALT : ML2183  & ML2182   earlier 97-99 models]	ML3123  = OE# 8178005000 & ML3124  = OE# 8177006000 = Open length 450mm or ML2183  OE# 8177005520 & ML2182  OE# 8178005520 = Open length 515mm
Azera 					
06-11	Azera sedan 3.3 V6	Bonnet "ML0266"	OE# 811613L001	Boot "ML3470"	OE# 817713L000
Creta / Grand Creta 					
17-20	Creta SUV gen 1 (GS/GC)			—	
21-on	Creta SUV gen 2 (SU2)			—	
22-on	Grand Creta LWB SUV			—	
Getz 					
03-11	Getz (TB)	—		Hatch Tailgate ML2775	
H-1 					
09-21	H-1 Minibus 9 seater / Van	—		Hatch Tailgate ML1147	
i10 					
08-18	i10 Hatch gen 1 (PA)	—		Hatch Tailgate ML3039	OE# 817700X000
14-July 20	Grand i10 Hatch gen 2 (IA / BA)	—		Hatch Tailgate ML3194	OE#s 81780B9000 / 81780B9010 / 81770B9000 / 81770B9010
Aug 20-on	Grand i10 Hatch gen 3 (AI3)	—			
i20 					
09-Jan 15	i20 Hatch gen 1 (PB)	—		Hatch Tailgate ML3367	OE#s 817701J000 / 817701J010 / 817801J000 / 817801J010
Feb 15-20	i20 Hatch gen 2 (GB)	—		Hatch Tailgate ML2999	OE#s 81780C8000 / 81780C8010 / 81770C8000 / 81770C8010
20-on	i20 Hatch gen 3 (BI3)	—			
i30 					
09-June'12	i30 Hatch gen1 (FD)	—		Hatch Tailgate ML1587	
July'12-16	i30 Hatch gen 2 (GD)	—		Hatch Tailgate ML2266	
July'17-18	i30 Hatch gen 3 (PD)	—			

Key

*	See important installation information on inside front cover
!	Excluding self-levelling suspension
"..."	Special order - phone 010 900 1850. 6-12 week waiting period

~	Imported
#	Internal bump stop
⊕	Steering damper

- It is recommended that all new shock absorbers are fitted in pairs
- Do not mix gas and non-gas units on the same axle
- **Bold** part numbers indicate heavy-duty shocks
- Underlined part numbers indicate parts not immediately available
- *Italic* part numbers followed by > indicate parts to be discontinued

Maxlift

Part number [alphabetical listing]

Year	Application	Front		Rear	
		Part number	Info	Part number	Info
HYUNDAI <i>continued</i>					
iX35 					
10-March 16	iX35 All (LM)	–		Tailgate ML2732	
For new iX35 Tucson ... see Tucson					
Sante Fe 					
01-06	Sante Fe 4X4 Gen 1 (SM)	Bonnet "ML5382"	OE# 81161-26000	Tailgate ML1711 > "ML5381" Glass "ML5297"	OE#'s: ML1711 > ML5381 = 81771-26010 ML5297 = 81711-26010, 8177026011
07-12	Sante Fe 4X4 Gen 2 (CM)	–		Tailgate ML3072 > "ML6169"	OE# ML3072 > ML6169 817702B001
13-18	Sante Fe 4X4 Gen 3 (DM)	Bonnet "ML5660"	OE#: 81160-2B010	Tailgate "ML6169"	OE#s 817702B001
18-on	Sante Fe 4X4 Gen 4 (TM)	–		–	
Staria 					
22-on	Staria	–		–	
Tucson 					
04 – 10	Tucson (JM)	–		Tailgate ML2230 / Rear Glass ML3530	
16-22	Tucson (TL)	–		Tailgate ML1454 (non-power)	ML1454 OE# 81780D7000 / 81781D3001 / 81770D7000 / 81771D3001
22-on	Tucson (NX4)	–			
JAGUAR <i>incl</i> DAIMLER					
F Pace 					
16-on	F Pace				
XF Series 					
08-16	XF 2.7D, 3.0, 4.2, 5.0 (EXCL XFR)	Bonnet "ML6205"		Boot "ML6204"	
JEEP					
Jeep Cherokee / Liberty 					
91-01	Jeep Cherokee 4x4 (MC) Sport, Limited & Country (XJ)	–		Tailgate ML1069 OR ML1681	Tailgate : Earlier models ML1069 = OE# 55027180 Later models ML1681 = OE# 55076208
02-07	Jeep Cherokee 4x4 (KJ)	Bonnet ML3211		Tailgate Glass ML3111	
08-13	Jeep Cherokee 4x4 (KK)	–		Main Tailgate ML1779 Rear Glass ML3184	
14-21	New Jeep Cherokee 4x4 Trailhawk (KL)	Bonnet ML3602		Manual Tailgate : Power Tailgate :	
Jeep Commander 					
07-09	Commander 3.0, 4.7 & 5.6 (XK)	–		Main Tailgate ML0635 > / Rear Glass ML3184	
Jeep Compass 					
07-16	Compass (MK) (MC) facelift	–		Tailgate ML2110	
17-22	Compass (MP)	–		–	
Jeep Grand Cherokee 					
93-98	Jeep Grand Cherokee All (ZJ series) (MC) Up-country Susp) Std Height	–		Main Tailgate ML2881L & ML2877R / Glass Tailgate ML2925	Main Tailgate ML2881L OE# = G0004857 / 55074783 / 5507570AB + ML2877R OE# = G0004856 / 55074782 / 55075704 AB
99-May'05	Jeep Grand Cherokee All (WJ series) (MC) Up country susp) Std Height	Bonnet ML4069		Main Tailgate ML2949 / Glass tailgate ML3581	
June'05 – Feb'11	Jeep Grand Cherokee All (WK series) (EXCL up country / raised susp)	Bonnet ML3734		Main Tailgate ML2364 / Glass tailgate ML3526	
March'11-on	Jeep Grand Cherokee All (WK2 series)	–		Main Tailgate ML0210 / Glass tailgate ML3210 >	
Jeep Patriot 					
07-10	Patriot 4x4 (MK)	–		Tailgate ML3355	
11-18	Patriot (MK2 – Facelift)	–		Tailgate ML3356	(with speakers) OE# 68061369AA OR 5054353AB
Jeep Renegade 					
15-on	Renegade SUV (BU)	–		Tailgate ML2660	

Key





*	See important installation information on inside front cover
!	Excluding self-levelling suspension
"..."	Special order – phone 010 900 1850. 6-12 week waiting period

~	Imported
#	Internal bump stop
⊕	Steering damper

- It is recommended that all new shock absorbers are fitted in pairs
- Do not mix gas and non-gas units on the same axle
- **Bold** part numbers indicate heavy-duty shocks
- Underlined part numbers indicate parts not immediately available
- *Italic* part numbers followed by > indicate parts to be discontinued

Maxlift

Part number [alphabetical listing]

Year	Application	Front		Rear	
		Part number	Info	Part number	Info
JEEP <i>continued</i>					
Jeep Wrangler 					
86-96	Jeep Wrangler 4x4 (YJ series)	—		—	
97-06	Jeep Wrangler 4x4 (TJ series)  Sport  Rubicon	—		Rear glass ML0665	
07-11	Jeep Wrangler 4x4 (JK series) 2 & 4 door  Rubicon & Unlimited	—		Rear glass ML1376	
12-18	Jeep Wrangler (JK series)			Rear glass ML2519	OE# 68068261AA
18-on	Jeep Wrangler (JL series)			—	

KIA					
Carnival 					
99-04	Carnival MPV GQ (gen 1)	Bonnet ML3471 > "ML5706"		Tailgate ML0223 > "ML5709"	
Picanto 					
April'04- June'11	Picanto Hatch (SA)	—		Hatch "ML5708"	OE# 8178007000, 8177007000
July'11- June'17	Picanto Hatch (TA)	—		Hatch ML6170	OE# 817701Y000, 817701Y010
July'17-on	Picanto Hatch (JA)	—			
Rio 					
00-Feb'06	Rio gen 1  facelift (DC)	—		—	
March'06- Oct'11	Rio gen 2 (JB)	—		Hatch ML2737	
Nov'11- May'17	Rio gen 3 (UB)	—		Hatch ML2764	
June 17-on	Rio gen 4 (YB)	—			
Sedona 					
04 - April'07	Sedona MPV gen 1 (GQ)	Bonnet "ML5706"	OE# 0K53Y56620 & 0K53Y56630 & 0K53Z56620 & 0K53Z56630	Tailgate ML0687	 OE# 0K53Z62620A & 0K53Z63620A
May'07-14	Sedona MPV gen 2 (VQ)	Bonnet "ML6118"	OE# 8111614D000	Tailgate "ML6234"	ML6234 = OE#s 817714D000 or 817814D000
May'14-on	Sedona MPV gen 3 (YP)	—		Tailgate ML1780 >	Manual Tailgate / OE#s 81771A9000, 81781A9000
Seltos 					
20-on	Seltos SUV (SP2i)				
Sonet 					
21-on	Sonet SUV (QY)				
Sorento 					
03-Oct 09	Sorento 4x4 & 4x2 (JC)	—		Tailgate ML1890 / Rear glass ML3721	
Nov 09- Feb 15	Sorento 4x4 & 4x2 (XM)	Bonnet ML3020		Tailgate ML2532 or ML2896	ML2532 OE# = 8178020500 ML2896 OE# = 817711U000 Both  power tailgate
March 15-on	Sorento 4x4 & 4x2 (UM)	Bonnet ML3904		Tailgate ML1974	 Power Tailgate / OE#s 81771C5000, 81771C5001, 81771C6000, 81781C5000, 81781C5001, 81781C6000
Soul 					
09-14	Soul hatch (AM)	—		Hatch ML3096 >	
End 14-19	Soul hatch (PS)	Bonnet ML0260		Hatch ML2656	Re-use OE end fittings / brackets
20-22	Soul hatch (SK3)				
Sportage 					
95-04	Sportage 4x4 & 4x2 Gen 1 (K00)	—		Tailgate ML3116	Vehicle with rear wiper
Nov'04- Sept'10	Sportage 4x4 & 4x2 Gen 2 (JE)	—		Tailgate ML1567	
Oct'10- March'16	Sportage 4x4 & 4x2 2.0, 2.4 Gen 3 (SL)	—		Tailgate ML4999	
April'16- Sept'22	Sportage 4x4 & 4x2 2.0, 2.4 Gen 4 (QL)	—		Tailgate ML1893	 power tailgate / Supplied  brackets
Oct '22-on	Sportage 4x4 & 4x2 2.0, 2.4 Gen 5 (N05)	—			

Key

*	See important installation information on inside front cover
!	Excluding self-levelling suspension
"..."	Special order - phone 010 900 1850. 6-12 week waiting period

~	Imported
#	Internal bump stop
⊕	Steering damper

- It is recommended that all new shock absorbers are fitted in pairs
- Do not mix gas and non-gas units on the same axle
- **Bold** part numbers indicate heavy-duty shocks
- Underlined part numbers indicate parts not immediately available
- *Italic* part numbers followed by > indicate parts to be discontinued

Maxlift

Part number [alphabetical listing]

Year	Application	Front		Rear	
		Part number	Info	Part number	Info
LAND ROVER					
Discovery 🚗					
99- end 04	Discovery 2	Bonnet ML3828	OE# = 6H5216C826BD	Tailgate ML1992	
end 04- "Oct'09	Discovery 3	Bonnet ML3458		Tailgate ML2894	
Oct'09-17	Discovery 4	Bonnet ML3458		Tailgate ML2894	
Oct 17-on	Discovery 5				
Discovery Sport 🚗					
15-Feb 20	Discovery Sport (L550)	Bonnet ML3906		Tailgate ML5005	Power tailgate / OE#s LR075419, LR075420
March 20-on	Discovery Sport (L550 Facelift)				
Evoque 🚗					
12-May19	Evoque SUV (L538)	Bonnet ML3886		Tailgate ML0767	Manual Tailgate / BJ32406A10AB, BJ32406A10AB, LR025379
June 19-on	Evoque SUV (L551)	-		-	
Freelander I 🚗					
98-March '07	Freelander I (L314)	-		-	
Freelander II 🚗					
April 07-15	Freelander II (L359)	Bonnet ML3828		Tailgate ML6005	OE#s 6H52406A10AF, LR002104
Range Rover 🚗					
76-96	Range Rover I Classic	-		Tailgate "ML5306"	
94-on April'02	Range Rover II Pegasus (P38A)	Bonnet "ML6436"		Tailgate "ML5649"	
May'02-12	Range Rover III 320i Sport (L322)	Bonnet "ML6004"		Tailgate "ML5872"	
13-21	Range Rover 320i Sport (L405)	-		-	
22-on	Range Rover 320i Sport (L460)	-		-	
Range Rover Sport 🚗					
05-12	Range Rover Sport (L320)	Bonnet ML3458		Tailgate ML6209	
13-22	Range Rover Sport (L494)	-		Tailgate ML6305	
23-on	Range Rover Sport (L461)	-		-	
Range Rover Velar 🚗					
17 - on	Range Rover Velar gen 1 (L560)				

For Leyland Mini ... see Austin

MAZDA

For 121 ... see SOHO

2 🚗 🚗					
07-15	Mazda 2 (DE)	-		Hatch Tailgate ML2352	
15-on	Mazda 2 (DJ)	-		-	
3 🚗 🚗					
04-09	Mazda 3 (BK)	-		Hatch Tailgate ML2018 / Sedan Boot "ML5764"	
Mid 09- Sept'14	Mazda 3 (BL)	-		Hatch Tailgate ML1783 ! ML1784 (#) / Boot "ML6424"	
Oct'14- June 19	Mazda 3 (BM)	-		Hatch Tailgate ML0953 ! ML0954 (#)	
July19-on	Mazda 3 (BP)	-		-	
323 🚗					
81-03	Mazda 323 323i Sting (gen 5 & 6)	-		Hatch ML0605 ! & ML0609 ! >	

Key

*	See important installation information on inside front cover
!	Excluding self-levelling suspension
"..."	Special order - phone 010 900 1850. 6-12 week waiting period

~	Imported
#	Internal bump stop
⊕	Steering damper

- It is recommended that all new shock absorbers are fitted in pairs
- Do not mix gas and non-gas units on the same axle
- **Bold** part numbers indicate heavy-duty shocks
- Underlined part numbers indicate parts not immediately available
- *Italic* part numbers followed by > indicate parts to be discontinued

Maxlift

Part number [alphabetical listing]

Year	Application	Front		Rear	
		Part number	Info	Part number	Info
MAZDA <i>continued</i>					
5 (Premacy) 🚗					
99-04	Mazda 5 Premacy MPV gen 1 (Cross border) 🚗	—		Tailgate ML2695 > ! , ML2696 > !	OE#s: ML2695 = C100636200 / ML2696 = C10062620
05-10	Mazda 5 MPV gen 2 (CR19)	—		—	
11-15	Mazda 5 MPV gen 3 (CW)	—		—	
6 🚗 🚗					
03-07	Mazda 6 (GG)	—		Boot "ML6014"	
08-12	Mazda 6 (GH)	Bonnet "ML6011"		—	
13-16	Mazda 6 (GJ)	—		—	
626 🚗					
83-93	Mazda 626	—		Hatch ML0605 ! > & ML0609 ! >	
93-99	Mazda 626 MX6	—		Hatch ML2687 > ! & ML2690 > !	
	Astina – see Etude				
CX3 🚗					
15-on	CX3 SUV crossover (DK)	—		—	
CX5 🚗					
12-17	CX5 SUV gen 1 (KE)	—		Tailgate ML3042 > ! & ML3043 > !	
18-on	CX5 SUV gen 2 (KF)	—		—	
Etude / Astina (also known as 323 or Familia cross border) 🚗 🚗					
94-99	Etude BH / Astina BA – J55 (RSA Mnf)	—		Hatch: ML2041 > ! ML2045 > !	
Soho 121 🚗					
97-99	121 Soho	—		Hatch Tailgate ML1413	
99-06	121 Soho	—		Hatch Tailgate ML1413	

MERCEDES-BENZ					
A Class W168 🚗					
00-04	A160, A170CDi A190 (W168)	—		Hatch Tailgate ML1980	
A Class W169 🚗					
05-12	A170, A180CDi, A200 (W169)	—		Hatch Tailgate ML2670	
A Class W176 🚗					
12-Aug 18	A180, A200 (W176)	—		Hatch Tailgate ML2192	
A Class W177 🚗					
Sept 19-on	A180, A200 (W177)	—		—	
B Class W245 🚗					
06-March '12	B170, B200T, B200CDi (W245)	—		Hatch Tailgate ML1959	
B Class W246 🚗					
April '12-18	B180, B200 (W246)	—		Hatch Tailgate ML6172	
B Class W247 🚗					
19-on	B180, B200 (W247)	—		—	
C Class W202 🚗					
94 – Aug '01	W202 C Class sedan	Bonnet ML4429		—	
C Class W202 🚗					
94 – Aug '01	W202 C Class S/Wagon	Bonnet ML4429		Tailgate "ML5307"	
C Class W203 🚗					
Sept'00-April'07	W203 C Class sedan	Bonnet ML2032 ! ML2034 !		Boot ML6173	
C Class W203 🚗					
Sept'00-April'07	W203 C Class S/Wagon	Bonnet ML2032 ! ML2034 !		Tailgate "ML6173"	

Key

*	See important installation information on inside front cover
!	Excluding self-levelling suspension
"..."	Special order – phone 010 900 1850. 6-12 week waiting period

~	Imported
#	Internal bump stop
⊕	Steering damper

- It is recommended that all new shock absorbers are fitted in pairs
- Do not mix gas and non-gas units on the same axle
- **Bold** part numbers indicate heavy-duty shocks
- Underlined part numbers indicate parts not immediately available
- *Italic* part numbers followed by > indicate parts to be discontinued

Maxlift

Part number [alphabetical listing]

Year	Application	Front		Rear	
		Part number	Info	Part number	Info
MERCEDES-BENZ <i>continued</i>					
C Class Sportcoupe CLC203 🚗					
00-11	CLC203 C Class coupe	Bonnet ML2032 ! ML2034 Ⓜ		–	
C Class W204 🚗					
May 07- May 14	W204 C Class sedan	Bonnet ML0638 ! ML0639 Ⓜ		–	
C Class S204 🚗					
May 07- May 14	W204 C Class S/Wagon	Bonnet ML0638 ! ML0639 Ⓜ		Tailgate (manuat) "ML6016" / Tailgate (power) "ML5719"	
C Class W205 🚗					
June 14- June 21	W205 C Class sedan	Bonnet ML3235 ! ML3236 Ⓜ	Re-use OE plastic cover / Left supplied with push button end fitting	–	
C Class W206 🚗					
July 21-on	W206 C Class sedan			–	
CLK C208 🚗 🚗					
98- March '02	🚗 CLK320 & CLK430 Coupe (C208)	Bonnet "ML5308"		–	
98-02	🚗 CLK320 & CLK430 Cabriolet (C208)	Bonnet "ML5308"		–	
CLK C209 & A209 🚗 🚗					
April 02-09	🚗 CLK320, CLK350 & CLK500 Coupe (C209)	Bonnet "ML5560" ! "ML5577" Ⓜ		–	
02 - 09	🚗 CLK320, CLK350 & CLK500 Cabriolet (A209)	Bonnet "ML5560" ! "ML5577" Ⓜ		Boot "ML5808"	
CLS W219 🚗					
06-July 11	CLS350 & CLS500 (W219)	Bonnet ML0525		–	
CLS W218 🚗					
Aug 11-18	CLS250 CLS350, CLS500 (W218)	Bonnet ML0525		–	
E Class W210 🚗					
95-July 02	W210 E Class sedan	Bonnet ML3017		–	
E Class W210 🚗					
96-July 02	T210 S/Wagon	Bonnet ML3017		Tailgate "ML5674"	
E Class W211 🚗					
Aug 02-09	W211 E Class sedan	Bonnet ML0525		–	
E Class W211 🚗					
Aug 02- mid 09	W211 E Class S/Wagon	Bonnet ML0525		–	
E Class W212 🚗					
Mid 09-16	W212 E Class sedan	Bonnet ML0674		–	
E Class S212 🚗					
Mid 09-16	W212 E Class S/Wagon	Bonnet ML0674		–	
E Class C207 🚗 A207 🚗					
Mid 09-16	E Class C207 Coupe / A207 Cabriolet	Bonnet ML0674		–	
E Class W213					
Mid 16-April 23	E Class W213 sedan	Bonnet ML3235 ! ML3236 Ⓜ	Re-use OE plastic cover / Left supplied with push button end fitting	–	
E Class W214					
May 23- on	E Class W214 sedan	–		–	
GLA Class X156 🚗					
14-19	GLA SUV (X156)	–		ML0552	Manual
GLA Class X156 🚗					
20-on	GLA SUV H247)	–		–	

Key

*	See important installation information on inside front cover
!	Excluding self-levelling suspension
"..."	Special order - phone 010 900 1850. 6-12 week waiting period

~	Imported
#	Internal bump stop
Ⓜ	Steering damper

- It is recommended that all new shock absorbers are fitted in pairs
- Do not mix gas and non-gas units on the same axle
- **Bold** part numbers indicate heavy-duty shocks
- Underlined part numbers indicate parts not immediately available
- *Italic* part numbers followed by > indicate parts to be discontinued

Maxlift

Part number [alphabetical listing]

Year	Application	Front		Rear	
		Part number	Info	Part number	Info
MERCEDES-BENZ <i>continued</i>					
GLC Class X253					
15-22	GLC SUV (X253)	—		—	
GLE (Was M Class)					
15-19	GLE SUV (W166) + Coupe (C292)	Bonnet ML0892 ML0896		Tailgate ML0815	W166 manual tailgate
19-on	GLE SUV (W167 / V167)	—		—	
GLS incl GL Class					
08-12	GL 4X4 SUV (X164)	Bonnet "ML6312" "ML6313"		—	
13-19	GL & GLS SUV 4X4 (X166)	Bonnet ML0892 ML0896		—	
20-on	GLS SUV 4X4 (X167)	—		—	
M Class W163					
98-05	ML SUV (W163)	Bonnet ML4399		Tailgate ML0683	
M Class W164					
06-May'12	ML SUV (W164)	Bonnet ML1431 & ML1432		Tailgate ML1703	Manual tailgate
M Class W166					
June'12-15	ML SUV (W166)	Bonnet ML0892 & ML0896		Tailgate ML0815	Manual tailgate
For newer M Class ... see GLE					
SLK R170					
96-Mid 04	SLK (R170)	Bonnet "ML6032"		Boot "ML5680"	
SLK R171					
Mid 04 - July'11	SLK (R171)	Bonnet ML0519		Boot ML4135	
SLK R172					
Aug'11-20	SLK (R172)	Bonnet "ML5798" "ML5799"		—	
Viano / C Class					
06-Sept 14	Viano 7 seater MPV (W639)	—		Tailgate ML0602	OE# = 6399800064 / 6399800164 / 6399800364
15-24	V Class 7 seater MPV (W447)	—		Tailgate ML0511 OR ML0512 OR ML0510 / Glass ML1927	ML0511 = Fixed rear window / ML0512 = Opening rear window / ML0510 = No rear window (van)
24-on	New V Class 7 seater MPV (W...)	—		—	
Vito					
02-04	Vito Minibus & Van 113 FWD (638 Gen 1)	—		Tailgate ML0185 > OR ML0183	ML0185 = Tailgate no rear wiper / ML0183 = Tailgate with rear wiper
04-Aug 15	Vito Minibus & Van RWD (W639 Gen 2)	—		Tailgate ML0602	
Oct '15 - 24	Vito Van 111 (1.6 FWD), 114, 116, 119 (2.2 RWD) (W447 Gen 3)	—		Tailgate ML0511 OR ML0512 OR ML0510 / Glass ML1927	ML0511 = Fixed rear window / ML0512 = Opening rear window / ML0510 = No rear window (van)
24-on	New Vito Van (W... Gen 4)	—		—	

MINI

For old Austin Mini ... see Austin

Mini One (New)

01-02	Mini One, Cooper, Cooper S, One D (R50 Mk I)	Bonnet ML1419		Hatch Tailgate ML2636	
02-06	Mini One, Cooper, Cooper S, One D (R50, R52, R53 Mk I)	Bonnet ML1419		Hatch Tailgate ML2636	
07-13	Mini One, Cooper, Cooper D, Cooper S, One D (R56, R57 Mk II) cabriolet	Bonnet ML4383		Hatch Tailgate ML2636	
14-24	Mini One, Cooper, Cooper D, Cooper S, One D (F55, F56 Mk III) cabriolet	Bonnet ML4219		Hatch Tailgate ML1918 OR ML2611	ML1918 = (F55) 5 door / ML2611 = (F56) 3 door
Mini Clubman					
08-14	Mini Clubman S/Wagon (R55)	Bonnet ML4383		Tailgate ML2636	
15-24	Mini Clubman S/Wagon (F54)	Bonnet ML4219		—	

Key

*	See important installation information on inside front cover
!	Excluding self-levelling suspension
"..."	Special order - phone 010 900 1850. 6-12 week waiting period

~	Imported
#	Internal bump stop
⊕	Steering damper

- It is recommended that all new shock absorbers are fitted in pairs
- Do not mix gas and non-gas units on the same axle
- **Bold** part numbers indicate heavy-duty shocks
- Underlined part numbers indicate parts not immediately available
- *Italic* part numbers followed by > indicate parts to be discontinued

Maxlift

Part number [alphabetical listing]

Year	Application	Front		Rear	
		Part number	Info	Part number	Info
MINI continued					
Mini Countryman 🚗					
11-16	Mini Countryman ML AWD (R60)	Bonnet ML4036		Hatch Tailgate ML2368	
17-24	Mini Countryman ML AWD (F60)	–		–	
Mini Coupe 🚗 🚗					
11-15	Mini Coupe (R58) & Roadster Cabriolet (R59)	Bonnet ML4383		–	
Mini Paceman 🚗					
13-16	Mini Paceman (R61)	Bonnet ML4036		–	
MITSUBISHI					
ASX 🚗					
11-on	ASX SUV	–		–	
Outlander I 🚗					
03-May'07	Outlander SUV (Gen 1) CU2W, CU5W	–		Tailgate ML2707	
Outlander II 🚗					
June'07-end'12	Outlander SUV (Gen 2, GS platform) CW5W	–		Tailgate ML2710	
Outlander III 🚗					
end 12-April 23	Outlander SUV (Gen 3)	–		Tailgate ML2066	
Outlander IV 🚗					
May 23-on	Outlander SUV (Gen 4)	–		–	
Pajero / Montero / Shogun 🚗					
88-91	Pajero 4x4 gen 1 (L146G)	–		–	
91-99	Pajero 4x4 gen 2 V Series: (NH, NJ, NK, NL)	–		–	
99-April'07	Pajero 4x4 gen3 (NM, NP)	–		–	
May'07-21	Pajero 4x4 gen 4 (NS)	–		–	
Pajero Sport / Montero / Challenger 🚗					
09-Aug 17	Pajero Sport SUV gen 2	–		–	
Sept 17-on	Pajero Sport SUV gen 3	–		–	
NISSAN					
Juke 🚗					
11-19	Juke Crossover (F15)	–		–	
Livina / Grand Livina / X-Gear 🚗					
07-13	Livina MPV 7 seater ML X-Gear & Grand Livina (X11J)	–		–	
Micra / March 🚗					
92-03	Micra (K11) cross border applications gen2	–		Hatch Tailgate "ML6040"	OE#s 90450-4F110, 90450-4F111
04-10	Micra (K12E) gen3	–		Hatch Tailgate ML2479	
11-June 18	Micra (K13) gen 4	–		Hatch Tailgate ML2224 or "ML5752"	ML2224 OE#s = 904501HB0A, 904511HB0A / ML5752 OE#s 1Q0827550A, 1Q0827550B
July 18 - on	Micra (K14) gen 5	–		–	
Murano 🚗					
05-end 08	Murano 3.5 V6 4x4 SUV (Gen 1)	Bonnet ML3560 >		Tailgate ML2163 > "ML6316"	
end 08-15	Murano 3.5 V6 4x4 SUV (Gen 2)	Bonnet ML3534 >		Tailgate "ML5177" or "ML6318"	"ML5177" Auto OE# 867827550C or "ML6318" manual OE#s 904501AA1A, 904511AA1A

Key



















*	See important installation information on inside front cover
!	Excluding self-levelling suspension
"..."	Special order – phone 010 900 1850. 6-12 week waiting period

~	Imported
#	Internal bump stop
⊕	Steering damper

- It is recommended that all new shock absorbers are fitted in pairs
- Do not mix gas and non-gas units on the same axle
- **Bold** part numbers indicate heavy-duty shocks
- Underlined part numbers indicate parts not immediately available
- *Italic* part numbers followed by > indicate parts to be discontinued







Maxlift

Part number [alphabetical listing]

Year	Application	Front		Rear	
		Part number	Info	Part number	Info
NISSAN continued					
NV200  					
14-on	NV200 panel van and MPV	Bonnet ML4164	OE#'s 654701PA0A / 654711PA0A		
NV350  					
14-on	NV350 panel van and minibus,  Impendulo taxi	Bonnet ML4164	OE#'s 654701PA0A / 654711PA0A		
Pathfinder 					
05-15	Pathfinder 2.5 Dci, 4.0 4x4 SUV (R51)	—		05-'08 Tailgate ML2711 > '09-15 Tailgate ML2718 > / Rear Glass ML3479	
Patrol 					
89- 97	Patrol S/Wagon 4x4 GQ / GR Y60 Series (Coil springs)	—		—	
98-17	Patrol S/Wagon 4x4 GR I & II / GU I & II Y61 Series (Coil springs)	Bonnet "ML5689" or "ML6289"	ML5689 OE# 51237060550 / ML6289 OE# 4A5827552	—	
13-on	Patrol S/Wagon 4x4 Y62 Series	—		—	
Qashqai 					
07-June 14	Qashqai SUV (J10)  +2 (7 seater)	—		Tailgate ML2243 or ML2411	5 seater = ML2243 OE# 90450JD01B, 90450JD01C / 7 seater (+2) = ML2411 OE# 90450EY10A, 90450EY11A
July'14-on	Qashqai SUV (J11)	—		Tailgate ML2084	OE# 904504EAOA, 904504EA1A, 904514EA1A
Sentra / Sabre   					
92- July 01	Sentra 140 (B13)	—		Boot ML4404	
92- July 01	Sentra & Sabre 160 (B13)	—		Boot ML4404	
92- July 01	Sentra & Sabre 200  (B13)	—		Boot ML4404	
92- July 01	Sentra & Sabre 200 With ABS (B13)	—		Boot ML4404	
Tiida  					
Aug'06-13	Tiida 1.6 & 1.8 Hatch / Sedan (X11C) Gen 1	—		Hatch Tailgate ML3450  & ML3451 	
X-TRAIL 					
02- March '08	X-Trail 4x2 and 4x4 All (T30, T30II)	—		Tailgate ML2111	
April'08- Aug 14	X-Trail 4x2 and 4x4 All (T31, T31R)	—		Tailgate ML1426	It may be necessary to re-use the OE end fitting brackets
Sept 14-April 22	X-Trail 4x2 and 4x4 All (T32)	—		—	
May22-on	X-Trail 4x2 and 4x4 All (T33)	—		—	

OPEL

For older Astra models ... see Kadett

Adam 					
14-19	Adam hatch (M13)	—		Hatch Tailgate "ML6394"	OE# 13352789
Astra					
Nov'99- Sept'04	 Astra hatch (model G)  S/Wagon)	—		Hatch Tailgate ML2029	
01-Sept'04	 Astra Caravan S/Wagon (model G)	—		S/Wagon Tailgate ML1514	
Sept'04-09	 Astra (model H)	Bonnet ML1958		Hatch Tailgate ML3348	
end 10- May 16	 Astra (model J)	—		Hatch Tailgate ML1320 > "ML6122"	
June 16-21	 Astra (model K) B16	—		Hatch Tailgate" ML6457"	

Key





















*	See important installation information on inside front cover
!	Excluding self-levelling suspension
"..."	Special order – phone 010 900 1850. 6-12 week waiting period

~	Imported
#	Internal bump stop
⊕	Steering damper









- It is recommended that all new shock absorbers are fitted in pairs
- Do not mix gas and non-gas units on the same axle
- **Bold** part numbers indicate heavy-duty shocks
- Underlined part numbers indicate parts not immediately available
- *Italic* part numbers followed by > indicate parts to be discontinued

Maxlift

Part number [alphabetical listing]

Year	Application	Front		Rear	
		Part number	Info	Part number	Info
OPEL continued					
Corso  					
96-02	Corso Hatch  Corsa LITE & Lite Sport	—		3 door hatch tailgate ML1941 5 door Hatch Tailgate ML1653	ML1941 (545mm) ML1653 (565mm) EXCL OE # 0132724 & 90481270 & 93299283
02-15	Corso LITE & Lite Sport – old shape Corso 	—		3 door hatch tailgate ML1941 5 door Hatch Tailgate ML1653	ML1941 (545mm) ML1653 (565mm) EXCL OE # 0132724 & 90481270 & 93299283
End 02- Oct 07	Corso Hatch  (300 Lite) (C)	—		Hatch Tailgate ML2939	
Nov'07- Oct 15	Corso Hatch  (300 Lite) (D)	—		Hatch Tailgate "ML5827" or ML1015 > ML5807	3 Door = "ML5827" / 5 Door = ML1015 > ML5807
Nov'15-19	Corso Hatch (E)	—		Hatch Tailgate ML0996 or "ML6362"	ML0996 (5 door) OE# 13428038 / ML6362 (3 door) OE# 13428064 (Poland)
20-on	Corso Hatch (F)	—		—	
Kadett / Monza / Astra					
Mid 85-88	  Kadett & Monza Sedan (F.W.D) "T car" (model E)	—		Hatch Tailgate ML1881	
89-92	  Kadett & Monza Sedan (F.W.D) "T car" (model E)	—		Hatch Tailgate ML1881	
93-Oct'99	  Kadett & Astra  S/Wagon) (model F)	—		Hatch Tailgate ML1250	
93-Oct'99	 Astra Estate S/Wagon (model F)	—		S/Wagon Tailgate ML2337	
For newer Astra models ... see Astra					
Meriva I 					
03-09	Meriva mini MPV (A)	—		Hatch Tailgate "ML5119"	
Meriva II 					
10-17	Meriva mini MPV (B)	—		Hatch Tailgate "ML6179"	
Mokka 					
15-April 22	Mokka (J13)	—		Tailgate ML0890	OE# 95095593
May 22-on	Mokka	—		—	
Vivaro  					
07-14	Vivaro van & minibus (X83)	—		Tailgate "ML5516"	OE# 91168256, 4414419
19-on	Vivaro van & minibus (KO)	—		—	
Zafira 					
01-05	Zafira 1.6, 1.8, 1.9CDTi, 2.2 MPV  2.0 turbo & OPC) (A)	—		Tailgate ML1923	
July'05-10	Zafira 1.6, 1.8, 1.9CDTi MPV (Exc OPC, Sport & Panoramic) (B)	—		Tailgate ML2288	

PEUGEOT

107 					
07-15	107 Hatch	—		Hatch Tailgate "ML5687"	OE# 68950-0H020
1007 					
06-08	1007 Harch	—		Hatch Tailgate "ML5730"	OE# 9649587680
206 					
00-12	206 Hatch	—		Hatch Tailgate ML2173	
206 					
02-12	206 S/Wagon	—		Tailgate ML1418 - "ML5449" / Rear Window "ML5340"	
206 CC 					
02-May'07	206 Cabrio cc	—		Boot "ML5343"	
207 					
06-12	207 Hatch  S/Wagon)	—		Hatch Tailgate ML2359	EXCL OE# 8731P9
207 CC 					
June'07- 12	207 Cabrio cc	—		Boot "ML5851"	

Key

*	See important installation information on inside front cover
!	Excluding self-levelling suspension
"..."	Special order – phone 010 900 1850. 6-12 week waiting period

~	Imported
#	Internal bump stop
⊕	Steering damper

- It is recommended that all new shock absorbers are fitted in pairs
- Do not mix gas and non-gas units on the same axle
- **Bold** part numbers indicate heavy-duty shocks
- Underlined part numbers indicate parts not immediately available
- *Italic* part numbers followed by > indicate parts to be discontinued

Maxlift

Part number [alphabetical listing]

Year	Application	Front		Rear	
		Part number	Info	Part number	Info
PEUGEOT <i>continued</i>					
208					
10/12-19	208 Hatch gen 1 (A9)	—		Hatch Tailgate ML2934 > "ML6180"	
19-on	208 Hatch gen 2 (P21)	—		—	
2008					
13-19	2008 SUV (A94)	—		Tailgate "ML6360"	
19-on	2008 SUV (P24)	—		—	
306					
98-01	306 Hatch (300 cc)	Bonnet "ML5267"		Hatch Tailgate ML1133 > "ML5323"	
306					
98-'02	306 S/Wagon (300 cc)	Bonnet "ML5267"		S/Wagon Tailgate ML0861 > "ML5432"	
307					
02-10	307 Hatch (300 cc)	—		Hatch Tailgate ML3007	
Sept'02-10	307 S/Wagon (300 cc)	—		S/Wagon Tailgate ML1675	
308					
08-14	308 Hatch (300 S/Wagon & CC)	—		Hatch Tailgate ML3027	
08-10	308 1.6 S/Wagon (300 Hatch & cc)	—		S/Wagon Tailgate "ML5889" (manual), or "ML6058 (Auto) S/Wagon Rear Glass "ML6060"	ML5889 (manual) OE# 8731.07 or ML6058 (auto) OE# 7000510263, 8731.08 ML6060 (Rear glass) OE# 7000510264, 9683422380, 8731.05
3008					
09-17	3008 MPV Crossover gen 1	—		Tailgate "ML6123"	
17-on	3008 MPV Crossover gen 2	—		—	
406					
95-'04	406 Sedan	Bonnet "ML5470"	OE#'s 9628157780, 9630662480, 792508, 792510	Boot "ML5180" or "ML5183 (check OE#'s)	OE#'s ML5180 = 9601430480, 9612604980, 8731A7. ML5183 = 9636450380, 8731A9
96-'04	406 Estate S/Wagon	Bonnet "ML5470"		Tailgate "ML5319"	
97-Feb'06	406 Coupe	Bonnet "ML5517"		Tailgate "ML5471"	
407					
Mid 04-10	407 Sedan	—		Boot "ML5727"	
407					
End 04-08	407 S/Wagon	—		Tailgate "ML5728" / Rear window "ML5729"	
4007					
09-10	4007 SUV	—		Tailgate "ML5776"	
4008					
12-16	4008 SUV	—		—	
504					
74-85	504 Estate S/Wagon	—		ML2477	
5008					
11-14	5008 1.6 THP MPV	—		Tailgate "ML6124"	
17-on	5008 MPV	—		—	
Partner					
99-08	Partner Grand Raid MPV (DW8B & DW10TD)	—		Tailgate "ML5113"	
09-18	Partner Tepee 8 seater	—		Tailgate "ML5948" Rear Glass "ML5954" or "ML5956"	ML5954 OE# OE 8731.V6 (length 543mm @ 200N) ML5956 OE# 8731.R8 (length 563mm @ 140N)
Partner					
09-08	Partner Panel Van	—		Tailgate "ML5113"	
09-on	Partner Panel Van	—		Tailgate "ML5948"	

Key

*	See important installation information on inside front cover
!	Excluding self-levelling suspension
"..."	Special order - phone 010 900 1850. 6-12 week waiting period

~	Imported
#	Internal bump stop
⊕	Steering damper

- It is recommended that all new shock absorbers are fitted in pairs
- Do not mix gas and non-gas units on the same axle
- **Bold** part numbers indicate heavy-duty shocks
- Underlined part numbers indicate parts not immediately available
- *Italic* part numbers followed by > indicate parts to be discontinued

Maxlift

Part number [alphabetical listing]

Year	Application	Front		Rear	
		Part number	Info	Part number	Info
PORSCHE					
Cayenne 🚗					
03-10	Cayenne 4x4 SUV (9PA)	Bonnet "ML6069"	OE# 7L5823359, 95551135900	Rear Glass "ML6068" / Tailgate TBA	ML6068 OE# 7L5845587B, 95551252800
11-17	Cayenne 4x4 SUV (92A)	Bonnet : "ML6319"	OE# 7P5823359, 95851135900	Tailgate TBA	
18-on	Cayenne 4x4 SUV (9YA)				
Macan 🚗					
14-on	Macan 4x4 SUV (95B)	Bonnet "ML6481"	OE# 95B823359	—	
RENAULT					
Captur 🚗					
13-19	Capture crossover SUV gen 1	Bonnet ML3596		Tailgate ML2862	
20-on	Capture crossover SUV gen 2				
Clio II 🚗					
99-12	Clio (NVA Va va voom)	—		Hatch Tailgate ML3397	
Clio III 🚗					
End 06-March '13	Clio	—		Hatch Tailgate ML3115	
Clio IV 🚗					
April'13-19	Clio	Bonnet "ML6215"	OE# 654703934R, 700021053500	Hatch Tailgate ML2864	
Clio V 🚗					
20-on	Clio	—		—	
Duster 🚗					
13-Sept 18	Duster SUV gen 1	Bonnet ML1316		Tailgate ML3442	
Oct 18-on	Duster SUV gen 2	—		—	
Kadjar 🚗					
16-18	Kadjar crossover SUV	—		Tailgate ML3312	
21-on	Kadjar crossover SUV	—			
Kangoo Multix 🚗					
June'04-08	Kangoo I Multix MPV people carrier (580kg payload)	—		Tailgate ML0422	
09-Nov 21	Kangoo II MPV	—		Tailgate ML0083	
Kangoo Express 🚗					
01-09	Kangoo I Express minivan (750kg payload)	—		Tailgate ML0422	
09-Nov 21	Kangoo II minivan	—		Tailgate ML0083	
Kiger 🚗					
21-on	Kiger SUV	—		—	
Koleos 🚗					
08-13	Koleos 4x4 SUV (HY)	—		Tailgate ML1340	
19-on	Koleos 4x4 SUV (HC)	—		—	
Kwid 🚗					
16-19	Kwid crossover SUV	—		—	
For Megane Scenic MPV – See "Scenic"					
Megane I 🚗					
95-'02	Megane Hatch (NVA "Shake it")	—		Hatch Tailgate ML3181	
96-'03	Megane Classic Sedan	—		Boot ML4014	
Megane I 🚗					
96-May'04	Megane Coupe	—		Hatch Tailgate ML4483	
Megane I 🚗					
97 – May'04	Megane Cabriolet	—		Boot ML4486	
For Megane Scenic MPV ... see Scenic					

Key



















*	See important installation information on inside front cover
!	Excluding self-levelling suspension
"..."	Special order – phone 010 900 1850. 6-12 week waiting period

~	Imported
#	Internal bump stop
⊕	Steering damper

- It is recommended that all new shock absorbers are fitted in pairs
- Do not mix gas and non-gas units on the same axle
- **Bold** part numbers indicate heavy-duty shocks
- Underlined part numbers indicate parts not immediately available
- *Italic* part numbers followed by > indicate parts to be discontinued

Maxlift

Part number [alphabetical listing]

Year	Application	Front		Rear	
		Part number	Info	Part number	Info
RENAULT <i>continued</i>					
Megane II 					
03-08	Megane II Sedan & Hatch ALL NCI Shake it	—		Hatch Tailgate ML3383	
Megane II 					
June'04-08	 Megane II cc Coupe	—		—	
June04-08	 Megane II cc Cabriolet	—		Boot ML3147	
For Megane Scenic MPV ... see Scenic					
Megane III 					
09-Aug 16	Megane III Hatch	Bonnet ML0608		Hatch Tailgate ML3270	
Megane III 					
09-Aug 16	Megane III cc Coupe and Cabriolet	Bonnet ML0608		Coupe Tailgate "ML6072"	OE# 90451002R
For Megane Scenic ... see Scenic					
Megane IV 					
Sept 16-22	Megane IV Hatch			Hatch Tailgate ML2460	
For Megane Scenic ... see Scenic					
Modus 					
05 - 08	Modus 1.2, 1.4, 1.6 Hatch / mini MPV	—		Hatch Tailgate "ML5724"	
Sandero & Stepway 					
09-13	Sandero hatch (NCI Stepway) (B90)	—		Hatch Tailgate ML2147	
13-20	Sandero hatch	Bonnet ML1404 >	OE# 654713274R	Hatch Tailgate ML6200	OE# 7000210536A0, 904529943R
Scenic I 					
96-Feb'04	Scenic MPV	—		Tailgate ML1233 / Glass only ML3022	ML1233 = W/Opening rear window OE#s 9637509380, 8436305, 792513
01-04	Scenic RX4 4x4	—		Tailgate ML1233	ML1233 = W/Opening rear window OE#s 9637509380, 8436305, 792513
Scenic II & Grand Scenic 					
March'04-end 09	Scenic II and Grand Scenic II (LWB)	—		Tailgate ML2198 OR ML2186 OR ML3690	ML2198 = Fixed rear window ML2186 = Opening rear window ML3690 = Rear glass
Scenic III 					
end 09-16	Scenic & Grand Scenic III MPV 1.6, 1.9dCi	Bonnet ML4208 / Bonnet ML4235	ML4208 = vehicles with 2 supports, OE# 654700008R / ML4235 = vehicles with 1 support, OE# 654702346R	Tailgate ML2060	
Triber 					
20-on	Triber 7 seater	—		—	
Twingo 					
08-13	Twingo hatch (gen 2)	—		Hatch Tailgate "ML5891"	
SMART					
ForFour 					
End 04-07	ForFour 1.3 Pulse & 1.5 Passion	—		Hatch "ML5895"	
ForTwo 					
03-07	ForTwo (450) gen 1	—		Hatch Tailgate "ML6083"	
08-14	ForTwo (451) gen 2	—		Hatch Tailgate "ML6083"	
14-on	ForTwo (453) gen 3	—		Hatch Tailgate "ML6464"	
SSANG YONG					
Kyron 					
06-12	Kyron 4x4 SUV (300 4x2 = special order)	—		Tailgate "ML5889"	
Rexton 					
02-12	Rexton I & II 270, 290TD, E320 4x4 SUV	Bonnet "ML5355"	OE# 7115008100	Tailgate "ML5334"	OE#s 7140608100, 7140608110, 7141608100, 7141608110

Key

*	See important installation information on inside front cover
!	Excluding self-levelling suspension
"..."	Special order - phone 010 900 1850. 6-12 week waiting period

~	Imported
#	Internal bump stop
⊕	Steering damper

- It is recommended that all new shock absorbers are fitted in pairs
- Do not mix gas and non-gas units on the same axle
- **Bold** part numbers indicate heavy-duty shocks
- Underlined part numbers indicate parts not immediately available
- *Italic* part numbers followed by > indicate parts to be discontinued

Maxlift

Part number [alphabetical listing]

Year	Application	Front		Rear	
		Part number	Info	Part number	Info
SUBARU					
Forester 2 🚗					
June 02-08	Forester AWD (SG)	–		Tailgate ML1762 > ML1763 > !	
Forester 3 🚗					
08-13	Forester AWD (SH)	–		Tailgate ML1903 > ML1904 > !	
SUZUKI					
Alto 🚗					
09-15	Alto hatch 1.0 (gen 7) HA25	–		Tailgate ML3680	
Baleno 🚗					
16-April 22	Baleno hatch gen 1 (WB, FW)	–		–	
May 22-on	Baleno hatch gen 2 (WB)	–		–	
Brezza 🚗					
21-23	Brezza SUV (XF)	–		–	
Celerio 🚗					
15-22	Celerio hatch gen 2 (FE)	–		–	
23-on	Celerio hatch gen 3	–		–	
Ertiga 🚗					
14 Feb 19	Ertiga 7 seater MPV (ZE)	–		–	
March 19-on	Ertiga 7 seater MPV (NC)	–		–	
	For Grand Vitara – see Vitara				
Ignis 🚗					
17-on	Ignis SUV gen 2 (MF)	–		–	
For Jimny – see SJ / Samurai					
SJ / Samurai / Jimny 🚗					
81-Sept 18	SJ410, SJ413, + SN413 (JA33, JB33), ! Samurai	–		Tailgate ML3101 > ML5492	OE# 81860A80100
Oct 18-on	Jimny (JB64, JB74)	–			
Swift 🚗					
08-10	Swift hatch (gen 3)	–		Tailgate ML3231 ! ML3232 ! > ML6086	OE#s 81800-63811, 81801-62811-000, 81850-62J00
11-Aug 18	Swift hatch (gen 4) ZC72S, ZC82S	–		Tailgate ML2309	OE#s 8185068840, 8185068L00, 8186068840, 8186068L00
Sept 18-on	Swift hatch (gen 5) ZC33S	–		–	
SX4 🚗					
End 08-March '14	SX4 2.0 4x2 & 4x4 SUV	–		Hatch Tailgate ML3215	! brackets / OE#s 8185079J00, 8186079J00, 8186079J01
April 14-17	SX4 2.0 4x2 & 4x4 SUV	–		Hatch Tailgate ML6196	OE# 81850 61M00
Vitara 🚗					
89-99	Vitara gen 1 (ET, TA)	–		–	
15-on	Vitara gen 4 (LY)	–		Tailgate ML2620	
Grand Vitara 🚗					
98-04	Grand Vitara 4x4 ! (XL) (gen 1) FT, GT	–		–	
05-20	Grand Vitara 4x4 (gen 2) JT, JB	–		Tailgate ML2776 >	
22-on	Grand Vitara 4x4 (gen 3)	–			

Key



*	See important installation information on inside front cover
!	Excluding self-levelling suspension
"..."	Special order – phone 010 900 1850. 6-12 week waiting period

~	Imported
#	Internal bump stop
⊕	Steering damper

- It is recommended that all new shock absorbers are fitted in pairs
- Do not mix gas and non-gas units on the same axle
- **Bold** part numbers indicate heavy-duty shocks
- Underlined part numbers indicate parts not immediately available
- *Italic* part numbers followed by > indicate parts to be discontinued

Maxlift

Part number [alphabetical listing]

Year	Application	Front		Rear	
		Part number	Info	Part number	Info
TATA					
Indica 					
04 - 16	Indica 1.4 Hatch (V2)  B-Line	—		Hatch Tailgate ML3183	
Indigo 					
10-Apr	Indigo S/Wagon	—		S/Wagon Tailgate ML3183	
TOYOTA					
Auris 					
07-March '13	Auris hatch (330N)	—		Hatch ML3153	
April '13-19	Auris hatch	—		Hatch ML3584	
Avanza  					
06-Dec 11	Avanza MPV & Panel Van	—		Tailgate ML2318  ML2319 	
Jan 12-21	Avanza MPV & Panel Van	—		Tailgate ML2318  ML2319 	
Aygo 					
11-Sept 15	Aygo hatch gen 1 (AB10)	—		Hatch Tailgate ML2246	
Oct '15-21	Aygo hatch gen 2 (AB40)	—		Hatch Tailgate ML1643	
Camry 					
93-Aug 01	Camry (RSA mnf) V30, XV10 gen 3	Bonnet ML3689 >  ML3693 > 		—	
96-01	Export Camry (Japan mnf) SXV20, MCV20, XV20 gen 5	Bonnet ML3619 >  ML3618 > 		—	
9/01-06	Camry (Australian mnf) ACV30, ACV31, ACV36, MCV30, MCV36, XV30 gen 6	Bonnet "ML6323"	OE# 53440AA011	—	
Carri 					
98-06	Conquest Carri Panel Van	—		Hatch Tailgate ML0778 >  ML0779 >  or ML1451	ML0778  ML0779  = OE#6896019626 / 6895080048
Condor 					
Mid 00- 05	Condor 4x2 & 4x4	—		Tailgate ML0360 >  ML0361 > 	
Corolla / Conquest / Tazz / Run X 					
84-88	Conquest  Twin Cam) (F.W.D)	—		Hatch Tailgate ML0709	
89-96	Conquest  Twin Cam & 1800 (F.W.D) P140 (EE90, AE92, CE90)	—		Hatch Tailgate ML0778 >  ML0779 >  or ML1451	ML0778  ML0779  = OE#6896019626 / 6895080048
96-June '06	Conquest / Tazz (EE90, AE92)	—		Hatch Tailgate ML0778 >  ML0779 >  or ML1451	ML0778  ML0779  = OE#6896019626 / 6895080048
Nov '02-Sept '07	RunX Hatch gen 9 (E120)	—		Hatch Tailgate ML2972	
For Corolla hatch between '07 & '19 - See Auris					
20-on	Corolla Hatch gen 12 (E210)	—		—	
For Corolla Verso ... see Verso					
Corolla Cross 					
21-on	Corolla Cross (XG10)	—		—	
Cressida 					
81-93	Cressida Sedan X35, X36 (MK1)	Bonnet ML3547 >		—	
86-92	Cressida Sedan  2,8 & 3,0 I.R.S.)	Bonnet ML3545 >  ML3549 > 		—	
Cressida 					
Mid 81-85	Cressida S/Wagon (Local Strut)	Bonnet ML3547 >		—	
86-92	Cressida S/Wagon	Bonnet ML3545 >  ML3549 > 		—	
CH-R 					
17-on	CH-R Crossover SUV coupe	—		—	
Etiós 					
12-20	Etiós hatch  Cross	—		—	

Key

*	See important installation information on inside front cover
!	Excluding self-leveling suspension
"..."	Special order - phone 010 900 1850. 6-12 week waiting period

~	Imported
#	Internal bump stop
⊕	Steering damper

- It is recommended that all new shock absorbers are fitted in pairs
- Do not mix gas and non-gas units on the same axle
- **Bold** part numbers indicate heavy-duty shocks
- Underlined part numbers indicate parts not immediately available
- *Italic* part numbers followed by > indicate parts to be discontinued

Maxlift

Part number [alphabetical listing]

Year	Application	Front		Rear	
		Part number	Info	Part number	Info
TOYOTA continued					
FJ Cruiser 🚙					
11-on	FJ Cruiser	Bonnet: ML3275 > ML3358		Rear Glass ML3250	
Fortuner 🚙					
March '06 - March 16	Fortuner SUV 3.0TD & 4.0 V6 4x4 and 4x2 High Rider	-		Tailgate ML2094 ⚡ & ML2095 ⚡	
April 16 - on	Fortuner SUV 2.4GD, 2.7, 2.8GD, 3.0TD & 4.0 V6 4x4 and 4x2 High Rider	-		-	
Hi-Ace Minibus / Taxi 🚐 / Panelvan 🚐					
69-10	Hi-Ace Minibus, Taxi & Panel van	-		Tailgate ML0407 ⚡ & ML0408 ⚡	
Innova 🚐					
11 - 15	Innova 2.7 MPV	-		Tailgate ML2318 ⚡ & ML2319 ⚡	
Landcruiser Station Wagon					
80 🚙					
90-98	Landcruiser 80 series S/Wagon . (ML) certain solid axle 105 series '98-'07 models)	Bonnet ML3381 ⚡ ML3377 ⚡		Tailgate ML3393	Without bracket
100 🚙					
98-07	Landcruiser 100 Series S/Wagon IFS, (ML) Lexus IFS & Torsion Bars	Bonnet ML3207 > ML6324		Tailgate ML2272 > ⚡ ML2271 > ⚡	
200 🚙					
08-on	Landcruiser 200 Series S/Wagon	Bonnet ML6345		-	
Landcruiser Pick-up					
79 🚙					
99-on	Landcruiser HZJ79 series LDV Rear leaf springs, Coil front Std Susp	-		-	
Prado 🚙					
97-'02	Prado 90 series 3 door SWB & 95 series 5 door LWB S/Wagon	-		-	
03-Oct09	Prado 120 / 125 Series (ML) Elec Susp)	Bonnet ML3070		-	
Nov'09-on	Prado J150 (EXCL elec Susp) 3.0 GRJ150, 4.0 KDJ150	Bonnet ML2106		Rear Glass ML2990	
Prius 🚗					
04-March '09	Prius Hybrid (NHW20, XW20) gen 2	-		Hatch Tailgate "ML5917"	
April'09-16	Prius Hybrid (ZVW30) gen 3	-		Hatch Tailgate "ML6134"	
16-21	Prius Hybrid (XW) gen 4	-		-	
Quantum 🚐 (MCV)					
05 - on	Quantum Van & Minibus (ML) Ses'fikile taxi (gen 5 Hi-Ace)	-		Tailgate ML0158 ⚡ & ML0157 ⚡ OR ML0744 ⚡ & ML0743 ⚡	ML0158 / 7 [length 790 mm] = High roof ML0744 / 3 [length 640 mm] = Low roof
For Run X ... see Corolla / Conquest / Run X					
RAV4 🚙					
01- Feb '06	RAV4 (ACA20,21 / ZCA 25, 26 / XA20) gen 2	-		-	
March '06 - 12	RAV4 (XA30) gen 3	-		Tailgate ML2372	OE#s 689500R010 OR 689600R010
13- Feb 19	RAV4 (XA40) gen 4	-		-	
March 19-on	RAV4 (XA50) gen 5	-		-	
Tazz 🚙					
96-June'06	Tazz	-		Hatch Tailgate ML1451	
Verso 🚙					
04-Oct'09	Corolla Verso MPV	-		Tailgate ML2059	OE# = 689500F010
Nov'09-12	Corolla Verso MPV	-		Tailgate ML2059	OE# = 689500F010

Key



*	See important installation information on inside front cover
!	Excluding self-levelling suspension
"..."	Special order - phone 010 900 1850. 6-12 week waiting period

~	Imported
#	Internal bump stop
⊕	Steering damper







- It is recommended that all new shock absorbers are fitted in pairs
- Do not mix gas and non-gas units on the same axle
- **Bold** part numbers indicate heavy-duty shocks
- Underlined part numbers indicate parts not immediately available
- *Italic* part numbers followed by > indicate parts to be discontinued

Maxlift



Part number [alphabetical listing]

Year	Application	Front		Rear	
		Part number	Info	Part number	Info
TOYOTA continued					
Yaris / Vitz  					
99-05	Yaris / Vitz Hatch  1.5 T-Sport (Cross border – non RSA) gen 1 (P10)	–		Hatch Tailgate "ML5821"	OE# = ML2059, 68960-09120
05 – Sept'11	Yaris Hatch & Sedan (NBC2) gen 2 (P90)	–		Hatch Tailgate ML5777	OE# = 6895000020, 6895000021, 6895000022, 6896000010, 6896000011, 6896000012
Oct'11-19	Yaris Hatch & Sedan gen 3 (P130)	–		Hatch Tailgate ML6184	OE# = 689600W620
18-21	Yaris Hatch & Sedan gen 3 (P150)	–		Hatch Tailgate ML6184	OE# = 689600W620
22-on	Yaris GR Hatch gen 4 (P210)	–		–	

For Toyota Lexus ... see Lexus

VOLKSWAGEN					
Beetle 					
99-Oct'12	New Beetle (Type 2)  cabriolet &  models with spoiler	Bonnet ML0450 >	OE# = 1C0823359E	Hatch tailgate ML1134	ML1134 OE# = 1C0827550E, 1J6827550A  models w/spoiler)
Oct'12-17	New Beetle (Type 2)			Hatch tailgate  spoiler "ML6398" / Hatch tailgate (with spoiler) ML0506	ML6398  spoiler) OE# = 5C5827550 / ML0506 (with spoiler) OE# = 5C5827550, A, D

















For CC ... see Passat CC

Caddy  					
04-May 15	Caddy All (2KA) gen 3	Bonnet ML3407 or ML6152	ML3407 (length 405mm, 460N) OE# = 1T0823359, A / ML6152 (length 361mm, 540N) OE# = 1T0823359C / D	Hatch Tailgate ML0303	
June 15-Oct 21	Caddy All (2KA, SA) gen 3 facelift	Bonnet ML3964	ML3964 (510N) OE# = 811613Z000, 811713Z000	Hatch Tailgate ML0303	
Nov 21-on	Caddy All (SB) gen 4	–		–	

For older Caddy bakkie ... see Golf LCV

For Caravelle ... see Kombi

For Citi ... see Golf 1

Eos 					
07-on	Eos Cabriolet	Bonnet "ML5738"	OE# 1Q0823359	Boot "ML5752"	OE# 1Q0827550A, 1Q0827550B
Golf 1 & Citi (Incl Jetta / Fox)  					
78-10	Golf I / Jetta I & Citi	–		Hatch Tailgate ML2477	
Golf 2 (Incl Jetta)  					
85- 93	Golf II & Jetta II	–		Hatch Tailgate ML2475 > or ML2473	ML2473 = OE#191827550B or ML2475 > = OE#191827550B / 191827550B
Golf 3 (Incl Jetta)  					
92-99	Golf III & Jetta III	Bonnet ML0250	OE# 1K0823359A	Hatch Tailgate ML2469 Jetta Boot = ML4213	ML2469 = OE#1H6827550 A
Golf 4 (Incl Jetta)   					
99-04 (Jetta till 2/06)	Golf IV & Jetta IV  Estate S/Wagon	Bonnet ML2485	ML2485 = OE#8L0823359B, OE#-1J0823359A/B/C/D or 1J0827359A/B	Tailgate ML2489 or (Gti) ML1134 Jetta Boot ML4125	ML2489 = OE#1J6 827 550 or ML1134 (Gti) = OE#1J6827550A ML4125 = OE # = 805827552 or 1J5827552
Golf 3 & 4 					
93-'04	Golf III & IV Cabriolet  16" wheels)	Bonnet ML2485	ML2485 = OE#8L0823359B	Boot ML4149	ML4149 OE# = 805 827 552 C/F, 3B5 827 550 A/E, 805 827 552 A/B/C/D/F, 8N0 823 359
Golf 5 					
04-Feb'09	Golf V (1K1)	Bonnet ML0250	OE # = 1K0823359A	Hatch Tailgate ML3095	
Golf 6 					
March '09-13	Golf VI (5K1)	Bonnet ML0271		Hatch Tailgate ML3199	
Golf 7 					
13-19	Golf VII (5G1)	Bonnet ML0166		Hatch Tailgate ML2048	
Golf 7 					
20-on	Golf VII (Mk8)	–		–	

For older Jetta models (ie Jetta 1, 2, 3, 4) ... see Golf

Key

*	See important installation information on inside front cover
!	Excluding self-levelling suspension
" ... "	Special order – phone 010 900 1850. 6-12 week waiting period

~	Imported
#	Internal bump stop
⊕	Steering damper

- It is recommended that all new shock absorbers are fitted in pairs
- Do not mix gas and non-gas units on the same axle
- **Bold** part numbers indicate heavy-duty shocks
- Underlined part numbers indicate parts not immediately available
- *Italic* part numbers followed by > indicate parts to be discontinued

Maxlift

Part number [alphabetical listing]

Year	Application	Front		Rear	
		Part number	Info	Part number	Info
VOLKSWAGEN continued					
Jetta 5					
March'06-Sept'11	Jetta V (1K2)	Bonnet ML0250	OE # = 1K0823359A	Boot ML3916	OE# 1K5827550C
Jetta 6					
Oct'11-19	Jetta VI (5C6)	-		Boot ML2722	OE# 506827550
Kombi / Microbus / T3 Caravelle / Transporter / Transporter pick-up (All rear aircooled engines)					
80-'03	Kombi, Panelvan, Microbus, Caravelle & Transporter Type III Front engine T4)	-		Tailgate ML2209	OE# 251829331A
Kombi / T4 Microbus / Caravelle / Transporter, Transporter pick-up (Front watercooled engine)					
90- July'04	Type IV Caravelle T4 2.5 Tdi, Transporter & Syncro 4WD (front engine)	-		Tailgate "ML5245" or ML1533 or ML0455 (check OE numbers)	ML5245 = OE#1701829331G or 701829331F ML1533 = OE#701829331H ML0455 = OE#701829331AB or 01829331Q or 7D0829331D
Kombi / Microbus / T5 Caravelle / Transporter, Transporter pick-up					
Aug'04 - 15	Type V Caravelle, Kombi, Transporter, Crew bus & Van T5 4Motion 4WD (front engine)	Bonnet ML3507		Tailgate Bus / Kombi = ML5575 / Van = ML0208 / Power Tailgate ML0428	ML5575 = 970N OE# 7H0827550 / ML0208 = 1080N OE# 7H0827550B, 7H0827550C / ML0428 OE# = 701829331T
Kombi / Microbus / T6 Caravelle / Transporter, Transporter pick-up					
16 - On	Type VI Caravelle, Kombi, Transporter, Crew bus & Van T6 4Motion 4WD (front engine)	Bonnet ML5832	OE#'s 7H0823359A, 7H0823359B, 7H0823359C	-	
LT Series Van					
03 - 06	LT 28, 32, 35 SWB Van	-		-	
03 - 06	LT 45, 46 LWB Van	-		-	
For Microbus ... see Kombi					
Passat					
99-05	Passat Sedan (B5)	Bonnet ML0299	OE# = 1B0823359C	Boot "ML5135" or "ML5193"	ML5135 OE#'s 3B5827550, 3B5827550A @ 490N / ML5193 OE#'s 3B5827550..., 3D5827550F, 3D5827552C, 8B5827550C, 8D5827550F, 8D5827552C @ 530N
05 - 11	Passat Sedan & S/Wagon (B6)	Bonnet ML0230		Boot ML3551 / S/Wagon Tailgate "ML5831"	ML5831 OE# 3C9827550
11-15	Passat sedan (B7)	Bonnet ML0268	OE# 3AA823359023	Boot ML3902	OE# 5618275508
15-19	Passat sedan (B8)	Bonnet "ML6365"	OE# 3G0823359	-	
Passat CC					
09-12	Passat CC AWD 4-Motion Syncro	Bonnet ML0230		-	
Polo					
98-Sept'02	Polo Classic Sedan & Playa Hatch (mk 3) sport susp	-		Hatch Tailgate ML2125	ML2125 OE# 6K6827550A
				Boot "ML5259"	ML5259 OE# 6K5827550C
Oct'02-Jan'10	Polo Classic Sedan and Hatch CrossPolo (mk 4 9N3)	-		Hatch Tailgate ML2495	ML2495 OE# 6Q6827550
				Boot ML4149 (open 278mm) or ML4111 (open 255mm)	ML4149 3B5827550A or 8D5827552C ML4111 OE# = 6Q5827550B (20mm shorter than ML4149)
Feb'10-Jan 18	Polo Hatch & Sedan Vivo, CrossPolo (mk 5 model 6R)	-		Hatch Tailgate ML2078	
Feb 18-on	Polo Hatch & Sedan Vivo, CrossPolo (mk 6 model AW)	-		Hatch Tailgate ML1896	ML1896 OE# 2G6827550 / A / B
Polo Vivo					
Feb'10-Feb 18	Polo VIVO Hatch (mk 4, 9N3)	-		Hatch Tailgate ML2495	ML2495 OE# 6Q6827550
March 18-on	Polo VIVO Hatch (mk 5, 6R)	-		Hatch Tailgate ML2078	
Scirocco					
09-17	Scirocco (137)	-		Hatch Tailgate "ML6100"	
Sharan					
98-07	Sharan MPV	Bonnet "ML5480"	OE# 7M3827550A	Tailgate ML1297 > "ML5127"	OE# 7M08275500 / F / G

Key

*	See important installation information on inside front cover
!	Excluding self-levelling suspension
"..."	Special order - phone 010 900 1850. 6-12 week waiting period







Key

~	Imported
#	Internal bump stop
⊕	Steering damper

- It is recommended that all new shock absorbers are fitted in pairs
- Do not mix gas and non-gas units on the same axle
- **Bold** part numbers indicate heavy-duty shocks
- Underlined part numbers indicate parts not immediately available
- *Italic* part numbers followed by > indicate parts to be discontinued

Maxlift

Part number [alphabetical listing]

Year	Application	Front		Rear	
		Part number	Info	Part number	Info
VOLKSWAGEN continued					
T-Cross 					
19-on	T-Cross (C11)	—		—	
T-Roc 					
20-on	T-Roc (A11, D11)	—		—	
Taigo 					
22-on	Taigo	—		—	
Tiguan 					
08-09	Tiguan gen 1 (5N)	—		Tailgate ML1670	
09-Sept 16	Tiguan gen 1 (5N)	—		Tailgate ML2220	OE# 5N0827550
Oct 16-23	Tiguan SUV gen 2 (AD / BW)	Bonnet ML0539	OE# = 5NA823359 / A	Tailgate ML0819 (Manual)	OE# 5NA827550B
24-on	Tiguan SUV gen 3	—		—	
Touareg 					
04-10	Touareg 4x4 (7L)	Bonnet ML2003		Rear Glass ML3855	
11-18	Touareg 4x4 (7P)	Bonnet ML0662		Tailgate ML1296	OE# 7P6827550
19-on	Touareg 4x4 (CR)	—		—	
Touran 					
04-10	Touran MPV gen 1 (1T)	Bonnet "ML5736"		Tailgate ML2358 > "ML5743"	
11 - 16	Touran MPV gen 1 facelift (1T)	Bonnet "ML5736"		Tailgate "ML6188"	
	For Transporter – see Kombi				
Up 					
13-on	Up hatch	—		Hatch ML6189	

VOLVO					
C30 					
07-13	C30 Hatch	—		Hatch Tailgate ML2814	
C70					
97-05	 C70 Coupe & Cabrio	—		Boot (Coupe) "ML5487"	OE# 9485706
06-14	 C70 Cabriolet	Bonnet ML0259 > ML5726		—	
S40 Incl older V40 & V50 					
95-April'00	S40 Sedan & V40 S/Wagon  Sport & T4	Bonnet ML0215		Boot ML5154 S/Wagon Tailgate ML1063	ML5154 OE#s 30852059, 30852060
April'00- May'04	S40 Sedan & V40 S/Wagon  Sport & T4	Bonnet ML0215		Boot = ML4001	OE#s 30819865, 819865
June '04- 12	S40 Sedan & V50 S/Wagon  T5 (Gen 2)	Bonnet ML0259 > ML5726		Boot (S40) ML3815 > ML5488 / Tailgate (V50) ML3311	ML5488 OE#s 30674203, 30674971
S60 					
00-10	S60 Sedan gen 1	Bonnet ('01-05) ML4370 / (05-10) ML4380	OE#s : ML4370 = 91546051 / ML4380 = 30674708	Boot ML4142	
10-18	S60 Sedan gen 2	Bonnet ML4024	OE# 31278769	Boot ML1874	OE# 31333127
19-23	S60 Sedan gen 3	—		—	
S70 					
97-'00	S70 Sedan	—		—	
S80 					
98-July'06	S80 Sedan gen 1	Bonnet ML4370		Boot "ML5489" or "ML5490"	ML5489 OE#s 9483297, 9483299 (310N) / ML5490 OE# 30649439 (370N)
Aug'06-14	S80 Sedan gen 2	Bonnet "ML5663"	(Poland)	—	
S90 					
97-98	S90 Sedan	Bonnet "ML1020"		—	
17-23	S90 Sedan	—		—	
For older V40 & all V50 ... see S40					
V40 					
Nov'12-on	V40 Hatch  T5 & Cross Country (Gen 3)	Bonnet ML0367	OE# 31298282	Hatch tailgate ML1500	OE#s 31395607, 31278560
For newer V40 hatch ... see V40					
For older V40 & V50 Station wagon ... see S40 sedan					

Key

*	See important installation information on inside front cover
!	Excluding self-levelling suspension
"..."	Special order – phone 010 900 1850. 6-12 week waiting period

~	Imported
#	Internal bump stop
⊕	Steering damper

- It is recommended that all new shock absorbers are fitted in pairs
- Do not mix gas and non-gas units on the same axle
- **Bold** part numbers indicate heavy-duty shocks
- Underlined part numbers indicate parts not immediately available
- *Italic* part numbers followed by > indicate parts to be discontinued

Maxlift

Part number [alphabetical listing]

Year	Application	Front		Rear	
		Part number	Info	Part number	Info
VOLVO <i>continued</i>					
V60 					
11-18	V60 S/Wagon  Cross Country	Bonnet ML4024		Tailgate ML1712	
V70 					
97- Feb'00	V70 S/Wagon Gen1	—		Tailgate "ML5529"	
March '00-07	V70 S/Wagon Gen 2	Bonnet ML4370		Tailgate ML3840	
07-10	V70 S/Wagon Gen 3	Bonnet "ML4068" > "ML5663"	OE# 30649516	Tailgate ML3998 OR ML3903	ML3998 = Power tailgate / ML3903 = Manual tailgate
V90 					
97- 98	V90 S/Wagon gen 1 ( XC90 4WD Cross Country)	—		Tailgate "M5312"	OE#'s 1355263, 6846014
17-23	V90 S/Wagon gen 2	—		—	
XC40 AWD 					
18-23	XC40 AWD SUV	—		—	
XC60 AWD 					
09-Sept 18	XC60 AWD SUV	Bonnet ML4032		Tailgate ML1714 ( auto power)	ML1714 = Manual tailgate
Oct 18-23	XC60 AWD SUV	—		—	
XC70 AWD 					
Feb'00-July'07	XC70 AWD SUV	Bonnet "ML5643"		Tailgate ML3840	
Aug'07-15	XC70 AWD SUV	Bonnet "ML4068" > "ML5663"		Tailgate ML3840	
XC90 AWD 					
02-July 15	XC90 AWD SUV gen 1	Bonnet ML2263		Tailgate ML2903	
Aug 15-23	XC90 AWD SUV gen 2	Bonnet ML3656		—	

Key

*	See important installation information on inside front cover
!	Excluding self-levelling suspension
"..."	Special order – phone 010 900 1850. 6-12 week waiting period

~	Imported
#	Internal bump stop
⊕	Steering damper

- It is recommended that all new shock absorbers are fitted in pairs
- Do not mix gas and non-gas units on the same axle
- **Bold** part numbers indicate heavy-duty shocks
- Underlined part numbers indicate parts not immediately available
- *Italic* part numbers followed by > indicate parts to be discontinued



REPLACE YOUR OLD GAS SPRINGS WITH MONROE® MAX-LIFT

MAX-LIFT, A PRODUCT FROM A NAME YOU TRUST!



DON'T WAIT ANY LONGER!

HATCH - BONNET - BOOT - REAR WINDOW - FOLDING TABLE - INDUSTRIAL EXTENSIONS*

*AVAILABLE VIA OUR SEARCH FUNCTION LISTING MORE THAN 50 END-FITTINGS & BALL STUDS.

EU.MONROE.COM

for more information about the products, warranty,
cataloging and technical support.

© All trademarks shown are owned by Tenneco Inc. or one or
more of its subsidiaries in one or more countries.





Universal applications

6mm ID end fitting for 6mm and 8mm rods



Clevis 5mm wide
EF9033
8mm hole

Clevis 8mm wide
EF9040 6mm hole
EF9131 8mm hole

Spacer
EF9023
15mm



Ball and steel socket ass
EF9015
10mm ball M8 thread

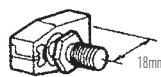

Ball and plastic socket ass
EF9013
10mm ball M8 thread

8mm ID end fitting for 10mm rods

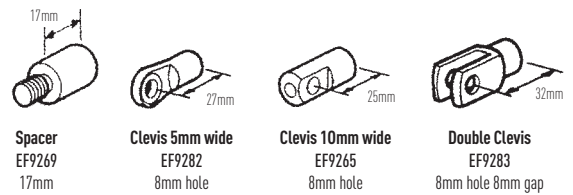

Spacer
EF9269
17mm

Clevis 5mm wide
EF9282
8mm hole

Clevis 10mm wide
EF9265
8mm hole

Double Clevis
EF9283
8mm hole 8mm gap



Ball and steel socket ass
EF9263
13mm ball M8 thread



Ball and steel socket ass
EF9264
10mm ball M8 thread



Clevis 8mm wide
EF9276 10mm hole
EF9277 8mm hole

Installation guide

- Always replace both lift supports to ensure top performance and to prevent twisting caused by uneven loading.
- Gas charged lift supports typically store a gas charge of over 330 Newton and cannot be compressed by hand.
- Gas charge lift supports can be installed in minutes with no special tools required.
- Careful inspection of all hinges and connecting points should be made for wear and tear or stress fractures. These should be replaced or repaired before lift supports installation.

Installation instructions

- Before removing old lift supports, examine any fittings supplied to determine which components must be re-used.
- Have someone hold the hatch, bonnet, boot or rear window open while replacing the lift supports
- The new lift support must be installed in the same position as the old one which was removed.
- Do not remove both lift supports at the same time. Replace one, then remove and replace the second one.
- Gas spring orientation i.e. it is important that the gas spring be mounted with the tube up in the closed position as this ensures lubrication and smooth operation

Important notes

When ordering a gas spring, please consider the following:

- Overall length from centre to centre (extended)
- Pressure
- Type of end fittings
- Year, make and model of vehicle

How to measure a gas spring

- Overall length is measured with strut fully extended and taken between the centre's of the fixing studs.
- Stroke is measured between top of strut barrel and end of shaft fitting.

How to measure a Maxlift

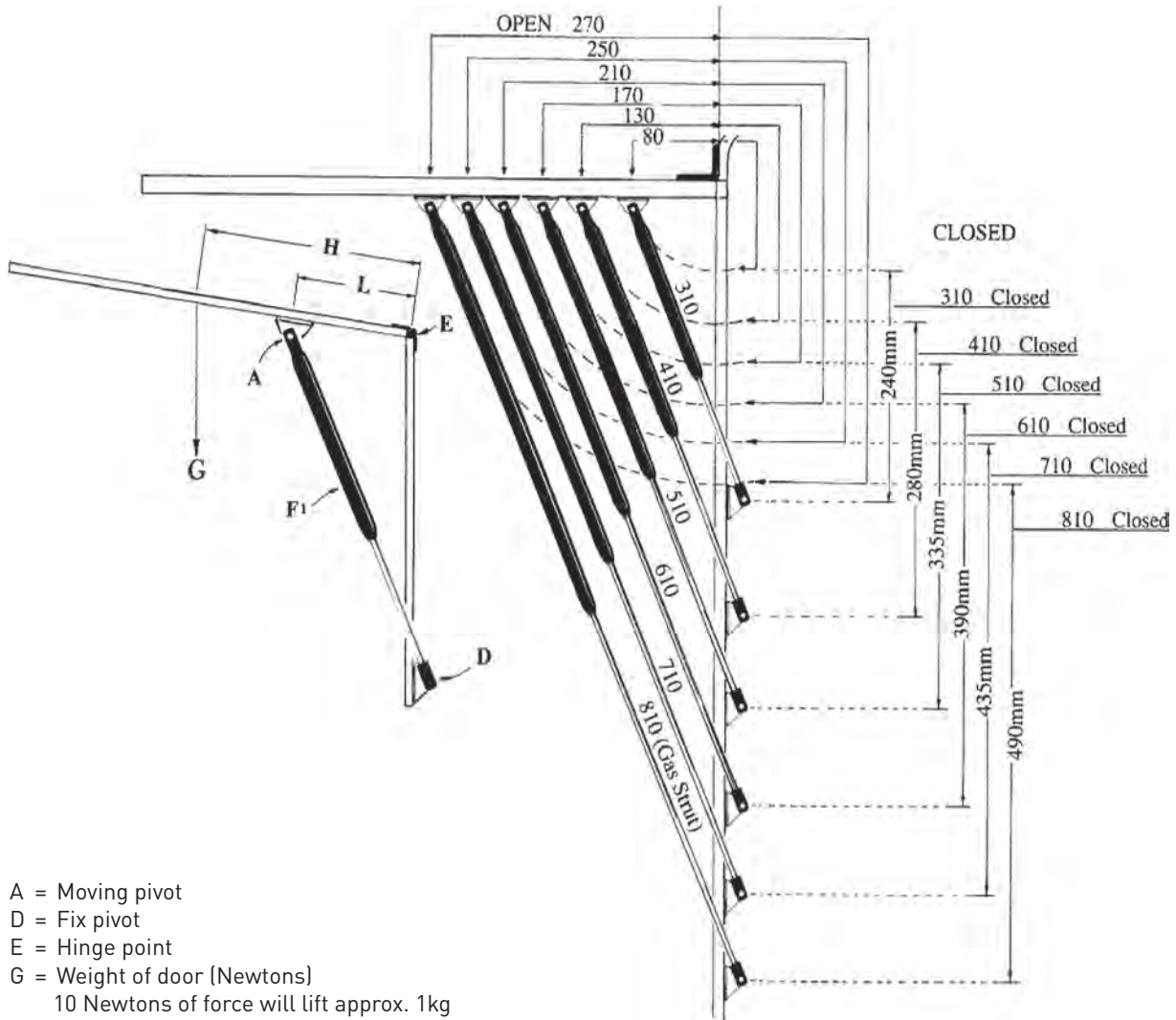

- A = Moving pivot
- D = Fix pivot
- E = Hinge point
- G = Weight of door (Newtons)
10 Newtons of force will lift approx. 1kg
- H = Half the depth of door
- F¹ = Force required
- L = Distance from hinge E to moving pivot A

Formula: $F^1 = \frac{G \times H}{L} + 15\%$ ÷ the number of gas springs required

Special note

Reducing the measurement from Point A to hinge point E by 20mm will give you an extra 10° (degrees) lift.

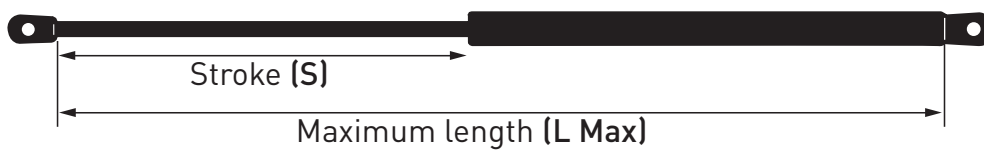

Universal

Maxlift universal applications by closed length (excl end fittings**)

OLD Maxlift part number	OLD Maxlift part pressure (N)	To be replaced by NEW Maxlift part number	Tube diameter (mm)	Rod diameter (mm)	Description	Gabriel cross ref*	New part number stroke (mm)	New part number open length (mm)	New part number closed length (mm)	New adjustable part number pressure (N)
		ML4398V	18	8	Universal	4040	75	200	125	Max 500N (can adj down)
		ML4382V	22	10	Universal	4164	75	209	134	Max 1000N (can adj down)
		ML4134V	18	8	Universal	4041	100	250	150	Max 500N (can adj down)
ML3782 >	400	ML3791V	18	8	Universal	4042	125	300	175	Max 500N (can adj down)
ML4289 >	490	ML3791V	15	6	Universal	Various	125	300	175	Max 500N (can adj down)
		ML3616V	18	8	Universal	4043	150	350	200	Max 500N (can adj down)
		ML3508	18	8	Canopy	4295	150	350	200	250N
		ML3512	18	8	Canopy	4297	150	350	200	350N
		ML3308V	22	10	Universal	4140	145	350	205	Max 1000N (can adj down)
ML3344 >	400	ML3324V	18	8	Universal	4044	175	400	225	Max 500N (can adj down)
		ML3316V	22	10	Universal	4141	170	400	230	Max 1000N (can adj down)
		ML2838V	18	8	Universal	4045, 4142 & 4294	200	450	250	Max 500N (can adj down)
		ML2834V	22	10	Universal	Various	195	450	255	Max 1000N (can adj down)
		ML2136V	18	8	Universal	4046, 4294, 4098	225	500	275	Max 500N (can adj down)
		ML2752	18	8	Canopy	4296	210	488	278	350N
		ML2132V	22	10	Universal	4143	220	500	280	Max 1000N (can adj down)
		ML3277	15	6	Universal	Various	152	432	280	400 N
		ML1460V	18	8	Universal	4047	250	550	300	Max 500N (can adj down)
ML1330 >	300	ML1444V	22	10	Universal	4144	240	550	310	Max 1000N (can adj down)
		ML0756V	18	8	Universal	4048	275	600	325	Max 500N (can adj down)
		ML0750V	22	10	Universal	4145	270	600	330	Max 1000N (can adj down)
		ML0510V	18	8	Universal	4049	300	650	350	Max 500N (can adj down)
		ML0499V	22	10	Universal	4146	295	650	355	Max 1000N (can adj down)
		ML0264V	18	8	Universal	4050	325	700	375	Max 500N (can adj down)
	300	ML0260V	22	10	Universal	4147	320	700	380	Max 1000N (can adj down)
		ML0150V	18	8	Universal	4051	350	750	400	Max 500N (can adj down)
ML0335 >	890	ML0149V	22	10	Universal	4148	345	750	405	Max 1000N (can adj down)
		ML0096V	18	8	Universal	4052	375	800	425	Max 500N (can adj down)
		ML0094V	22	10	Universal	4149	370	800	430	Max 1000N (can adj down)
		ML0042V	22	10	Universal	4150	395	850	455	Max 1000N (can adj down)
		ML0026V	22	10	Universal	4151	420	900	480	Max 1000N (can adj down)
ML0033 >	375	ML0008V	22	10	Universal	4152	445	950	505	Max 1000N (can adj down)
		ML0004V	22	10	Universal	4153	470	1000	530	Max 1000N (can adj down)

*NOTE 1: Gabriel numbers used for cross-reference purposes only

**NOTE 2: End fittings to be ordered separately (see p187)

ML1... to ML4... from Turkey | ML5... from Poland



NEW WARRANTY.

DO THE COMPLETE JOB, GET THE 5 YEAR WARRANTY.

5-YEAR

★ ★ ★
WARRANTY
★ ★ ★



Enjoy the assurance of a **5 year warranty** on any qualifying Monroe product when completing a full replacement of shocks and struts in pairs, including protection and if applicable mounting kits. 5* Years of world-class comfort, control and safety. 5 Years of superior confidence.











At Monroe, we're investing more than ever in our business... and your satisfaction. Learn more today at www.monroe.com

*Limitations apply. See www.monroe.com/en-za/ for details.

PRMMN2136-EN

Passenger and light commercial

Part number [numerical listing]

Part number	Make	Year	Application	Position	Mounting information
R1566 (oil shock)	CHEVROLET	72-78	 2500, 3800 & 4100 Sedan	Rear	⊥ ⊕
R1566 (oil shock)	CHEVROLET	76-82	Chevaïr & Ascona Sedan	Rear	⊥ ⊕
R1566 (oil shock)	CHEVROLET	78-92	 Rekord & Commodore Sedan	Rear	⊥ ⊕
R1566 (oil shock)	OPEL	78-91	 Rekord & Commodore Sedan	Rear	⊥ ⊕
R1566 (oil shock)	OPEL	91-95	 Rekord 4 Cylinder (Solid Axle)	Rear	⊥ ⊕
R1566 (oil shock)	FORD	71-Mid 83	Cortina Sedan & S/Wagon MKIII & MKIV + MKV S/Wagon [EXC] MKV sedan	Rear	⊕ ⊕
R2029 (oil shock)	MERCEDES-BENZ	68-73	250 & 280 All (108 Series)	Front	⊥ ⊗
R2029 (oil shock)	MERCEDES-BENZ	62-67	190, 200, 230 (110 Series)	Front	⊥ ⊗
R2029 (oil shock)	MERCEDES-BENZ	60-68	220, 250 & 280 (111 Series)	Front	⊥ ⊗
R2030 (oil shock)	MERCEDES-BENZ	62-67	190, 200, 230 (110 Series)	Rear	⊥ ○
R2030 (oil shock)	MERCEDES-BENZ	60-68	220, 250 & 280 (111 Series)	Rear	⊥ ○
R2030 (oil shock)	MERCEDES-BENZ	68-73	250 & 280 All (108 Series)	Rear	⊥ ○
R2775 (oil shock)	MAHINDRA	end 15 - Jan '22	Scorpio 4x2 & 4x4 SUV (S11) gen 1 facelift (12mm ID top mtng & 16mm btm mtng ID, Closed 314mm, open 503mm)	Rear	⊕ ⊕
R2777 (oil shock)	TATA	04 -16	Telcoline 2.0 4x2 & 4x4 LDV Steering Damper ⊕	Front	⊕ ⊕
R2777 (oil shock)	TATA	07-19	Xenon 4x2 & 4x4 LDV Steering Damper ⊕	Front	⊕ ⊕
R2777 (oil shock)	TATA		Safari SUV 4x4 Steering Damper ⊕	Front	⊕ ⊕
R3469 (oil shock)	DAIHATSU	98-04	Cuore L700 & L701 gen 5 [EXC] L710 AWD	Rear	○ ○
R3469 (oil shock)	DAIHATSU	98-01	Move L901	Rear	○ ○
R3469 (oil shock)	DAIHATSU	98- Feb'05	Sirion hatch (M100 / M101) – Cross border = Storia / Toyota Duet	Rear	○ ○
R3469 (oil shock)	DAIHATSU	01-07	YRV mini-MPV M2, [EXC] Turbo, [EXC] AWD	Rear	○ ○
R3472 (oil shock)	FIAT	01-06	Seicento 1100	Rear	⊕ ⊕
R3726 (oil shock)	VOLKSWAGEN	81-87	  Passat Sedan & S/Wagon (B2)	Rear	⊗ ⊕
R6652 (oil shock)	PEUGEOT	95-'04	 406 Sedan [EXC] elec susp)	Rear	⊥ ⊕
R6653 (oil shock)	PEUGEOT	96-'04	(S/W) 406 2.0 Estate S/Wagon [EXC] elec susp)	Rear	⊥ ⊕
R7275 (oil shock)	TATA	12-on	Super Ace 1 ton drop side LCV 1.4	Rear	⊕ ⊕
R7610 (oil shock)	RENAULT	08-13	Twingo hatch 1.2, 1.5TD, gen 2, [EXC] RS Sport (CND)	Front	⊕
R7612 (oil shock)	RENAULT	08-Nov '20	Kangoo 2 MPV & minivan (Check OE front strut outer diameter = 47mm & btm bracket 27mm wide)	Front	⊕
R11040 (oil shock)	MAZDA	Mid 81-85	323 F.W.D (BD 5th gen)	Front	⊕
10053	FIAT	01-06	Seicento 1100	Front	⊕
11272	RENAULT	99-13	Clio 1.2 [EXC] Va va vroom [EXC] 1.2 16v, 1.4 & 1.6, 2.0 & 3.0 V6)	Front	⊕
11273	RENAULT	99-06	Clio 1.2 16v, 1.4, 1.5dCi & 1.6 [EXC] Sport 1.6, 2.0 & 3.0)	Front	⊕
11285	RENAULT	01-09	Kangoo 1 Multix 1.4 MPV people carrier (580kg payload, 2 rear torsion bars), and Kangoo 1 Express minivan 1.4 & 1.5dCi (750kg payload, 4 rear torsion bars) [EXC] 4x4)	Front	⊕
16226	FORD	Mid 99 -03	 Fiesta 3 door 1.6 RSi & ST sport with power steering Mk4 facelift (JA, JB)	Front	⊕
16242	RENAULT	95-'02	  Megane Hatch & '96-'03 Classic Sedan [EXC] 2.0 16v) Small s/pan	Front	⊕
16242	RENAULT	96-May'04	Megane Coupe [EXC] 2.0 16v) Small s/pan	Front	⊕
16242	RENAULT	97 - May'04	Megane Cabriolet [EXC] 2.0 16v) Small s/pan	Front	⊕
16242	RENAULT	96-Feb'04	Scenic 1.4 & 1.6 Manual [EXC] RX4) Small s/pan	Front	⊕
16242	RENAULT	June'98-Feb'04	Scenic 1.6 Automatic, 1.9dCi, 2.0 [EXC] RX4) Small s/pan	Front	⊕
16306	FIAT	04-Feb'12	Punto 1.2, 1.3 JTD, 1.4 Hatch (MkII) (188) No bracket under the springseat.	Front	⊕
16454	FIAT	03-10	Stilo 1.6 Hatch	Front	⊕
16454	FIAT	03-10	Stilo 1.6 Multi Wagon	Front	⊕
16455	FIAT	03-10	Stilo 1.8, 1.9 JTD Hatch	Front	⊕

Key

*	See important installation information on inside front cover
!	Excluding self-levelling suspension
"..."	Special order – phone 010 900 1850. 6-12 week waiting period

~	Imported
#	Internal bump stop
⊕	Steering damper

- It is recommended that all new shock absorbers are fitted in pairs
- Do not mix gas and non-gas units on the same axle
- **Bold** part numbers indicate heavy-duty shocks
- Underlined part numbers indicate parts not immediately available
- *Italic* part numbers followed by > indicate parts to be discontinued

Passenger and light commercial

Part number [numerical listing]

Part number	Make	Year	Application	Position	Mounting information
16455	FIAT	03-10	Stilo 1.9 JTD Multi Wagon	Front	
16776	FIAT	00-03	Palio hatch Type 1X MkI	Front	
16776	FIAT	00-02	Palio Weekend S/Wagon Type PY & 1Y	Front	
16776	FIAT	00-02	Siena sedan Type 2A	Front	
23443	TOYOTA	84-88	Hi-Ace SWB Minibus (H50)	Rear	○ ○
23443	TOYOTA	84-88	Hi-Ace SWB Panelvan	Rear	○ ○
23473	FIAT	04-Feb '12	Punto 1.2, 1.3 JTD, 1.4 Hatch (MkII) (188)	Rear	⊖ ⊖
23473	FIAT	04-05	Punto 1.8 HGT 1.6v 3 door Hatch, plus 1.4 Sport Susp (MkII) (188)	Rear	⊖ ⊖
23858	HONDA	96- March '01	Ballade & Civic Vtec (EJ9, EK1, EK3, EK4) Mk6	Front	⊥ ⊗
23859	HONDA	92-95	Ballade All imported Encore & CRX (With rear bottom U brackets) Mk5 EG or EH	Rear	⊥ ⊗
23859	HONDA	96- March '01	Ballade & Civic Vtec (With rear bottom U brackets) (EJ9, EK1, EK3, EK4) Mk6	Rear	⊥ ⊗
23868	NISSAN	Sept'98-02	Primera 1.6 Si ; 2.0 Si & Gsi (2.0 Sti)	Rear	⊥ ⊖
23869	NISSAN	Sept'98-02	Primera 2.0 Sti	Rear	⊥ ⊖
23872	NISSAN	Sept'98-02	Primera 1.6 Si ; 2.0 Si & Gsi (2.0 Sti)	Front	⊥ ⊖
23872	NISSAN	Sept'98-02	Primera 2.0 Sti	Front	⊥ ⊖
23896	RENAULT	99-13	Clio 1.2 Va va vroom (1.2 16v, 1.4 & 1.6, 2.0 & 3.0 V6)	Rear	⊥ ⊖
23896	RENAULT	99-06	Clio 1.2 16v, 1.4, 1.5dCi & 1.6 (Sport 1.6, 2.0 & 3.0)	Rear	⊥ ⊖
23896	RENAULT	99-06	Clio 1.6 16v Sport (2.0 16v Sport & 3.0 V6 mid engine)	Rear	⊥ ⊖
23904	FORD	03-Oct '04	Focus 1.6 Hatch & Sedan MkI DAW (2.0 & St170)	Rear	⊥ ⊖
23904	FORD	00-Oct '04	Focus 2.0 & ST170 Hatch and Sedan MkI	Rear	⊥ ⊖
23905	AUDI	Feb'99-Nov'00	A4 Sedan (Sport susp, Avant S/W & Quattro) B5, 8D	Rear	⊥ ⊖
23907	VOLVO	95- May'99	S40 Sedan & V40 S/W (Sport & T4)	Rear	⊥ ⊖
23907	VOLVO	95- May'99	S40 Sedan & V40 S/W T4 and Sportline	Rear	⊥ ⊖
23907	VOLVO	June'99-April '00	S40 Sedan & V40 S/W (Sport & T4)	Rear	⊥ ⊖
23907	VOLVO	June'99-April '00	S40 Sedan & V40 S/W T4	Rear	⊥ ⊖
23910	TOYOTA	99-05	Yaris / Vitz Hatch 1.5 T-Sport (Cross border - non RSA) gen 1 (XP10)	Rear	⊥ ○
23915	OPEL	01-05	Zafira 1.6, 1.8, 1.9CDTi, 2.2 MPV (2.0 turbo & OPC) (A)	Rear	⊖ ⊖
23932	VOLVO	April '00-May'04	S40 Sedan & V40 S/W (Sport & T4) OE# = 16402	Rear	⊥ ⊖
23932	VOLVO	April '00-Late'04	S40 Sedan & V40 S/W T4	Rear	⊥ ⊖
23957	VOLKSWAGEN	98-07	Sharan MPV (7M8, 7M9, 7M6)	Rear	⊖ ⊖
23963	FIAT	07-15	Bravo (198 generation II) 1.4, 1.9 (sport susp)	Rear	⊥ ⊖
23963	FIAT	03-10	Stilo 1.6 Hatch	Rear	⊥ ⊖
23963	FIAT	03-10	Stilo 1.8, 1.9 JTD Hatch	Rear	⊥ ⊖
23963	FIAT	03-10	Stilo 2.4 Abarth Hatch	Rear	⊥ ⊖
23964	OPEL	02-11	Combo Panel Van (C)	Rear	○ ○
23964	OPEL	03-09	Meriva 1.4, 1.6, 1.7CDTi, 1.8 mini MPV (A)	Rear	⊖ ⊖
23965	FIAT	00-03	Palio hatch Type 1X MkI	Rear	⊥ ⊖
23965	FIAT	03-10	Palio II hatch Type 2H MkIV	Rear	⊥ ⊖
23965	FIAT	01-10	Palio Expresso panel Van	Rear	⊥ ⊖
23965	FIAT	00-02	Siena sedan Type 2A	Rear	⊥ ⊖
23965	FIAT	02-10	Siena II sedan	Rear	⊥ ⊖
23966	CITROEN	04-11	C2 1.1i, 1.4i, 1.6i (Sport Susp) (JM)	Rear	○ ○

Key



*	See important installation information on inside front cover
!	Excluding self-levelling suspension
"..."	Special order - phone 010 900 1850. 6-12 week waiting period

~	Imported
#	Internal bump stop
⊖	Steering damper

- It is recommended that all new shock absorbers are fitted in pairs
- Do not mix gas and non-gas units on the same axle
- **Bold** part numbers indicate heavy-duty shocks
- Underlined part numbers indicate parts not immediately available
- *Italic* part numbers followed by > indicate parts to be discontinued

Passenger and light commercial

Part number [numerical listing]

Part number	Make	Year	Application	Position	Mounting information
23966	CITROEN	02-May'06	C3 1.4i, 1.6i manual. 302 1.6 auto, Hdi 80kw & 82kw 51mm OD strut base (FC / FN)	Rear	○ ○
23966	CITROEN	02-May'06	C3 1.6i 16v auto & Hdi 80kw & 82kw 302 46mm OD strut base. (FC / FN)	Rear	○ ○
23966	CITROEN	June'06-Nov'09	C3 (facelift) 1.4, 1.6 (FC / FN)	Rear	○ ○
23966	PEUGEOT	06-08	1007 Harch 1.6	Rear	○ ○
23967	RENAULT	11-17	Fluence sedan	Rear	⊖ ⊖
23967	RENAULT	03-08	Megane II Sedan & Hatch All 100 Shake it 302 2.0 T Sport)	Rear	⊖ ⊖
23967	RENAULT	June'04-08	 Megane II cc Coupe 1.6, 1.9dCi, 2.0	Rear	⊖ ⊖
23967	RENAULT	June'04-08	 Megane II cc Cabriolet 1.6, 1.9dCi, 2.0	Rear	⊖ ⊖
23968	HONDA	03-04	Jazz 1.4 Dsi & 1.5 Vtec gen 1 (GD)	Rear	⊥ ⊖
23968	HONDA	05-07	Jazz 1.4 Dsi & 1.5 Vtec gen 1 (GD facelift)	Rear	⊥ ⊖
23970	HONDA	March '01-05	 Civic Vtec 5 door hatch (EP, EU) Mk7 1.3, 1.4, 1.5, 1.6, 1.7i	Rear	⊥ ⊖
23970	HONDA	March '01-05	Civic Vtec 5 door hatch (EP, EU) Mk7 1.3, 1.4, 1.5, 1.6, 1.7i 2.0 302 Type R) & 1.7D	Rear	⊥ ⊖
23971	HONDA	March '01-05	 Civic Vtec 4 door Sedan (ES) Mk7	Rear	⊥ ⊖
23972	NISSAN	04-10	Micra (K12E) gen3	Rear	⊥ ○
23972	NISSAN	06-12	Note hatch (Cross border markets)	Rear	⊥ ⊖
23977	FIAT	04-10	Panda 1.2, 1.3 EXCL AWD & 1.4 100HP) (169)	Rear	⊖ ⊖
23980	MAZDA	03-07	Mazda 6 302 MPS gen 1 (GG)	Rear	○ ○
23982	OPEL	01-Sept'04	(S/W) Astra Caravan S/Wagon (G)	Rear	⊖ ⊖
23982	OPEL	Sept'04-09	 Astra 1.4 & 1.6 (model H)	Rear	⊖ ⊖
23982	OPEL	Sept'04-09	 Astra 1.8, & 1.9 CDTi 100 GTC 302 elec susp (model H)	Rear	⊖ ⊖
23982	OPEL	07-10	Astra Twintop 1.8 & 2.0 	Rear	⊖ ⊖
23988	FORD	Nov'04-July'11	Focus 1.6, 1.6Si, 1.8TDCi, 2.0, 2.0Si, 2.0TDCi & TDCi Si, 100 2.5 ST front only, Hatch and Sedan MkII DA, DP EXCL 2.5 ST rear & RS)	Rear	⊥ ⊖
23988	FORD	Aug '11-18	Focus Hatch and Sedan MkIII C346 Including facelift models EXCL 2.0ST rear, RS)	Rear	⊥ ⊖
23989	MINI	01-06	Mini One, Cooper, Cooper S, One D (R50, R52, R53 Mk I)	Rear	⊥ ⊖
23990	VOLKSWAGEN	04 - May 15	Caddy All gen 3 (2K) (check front strut OD for correct part) 50mm OD strut tube	Rear	⊖ ⊖
23990	VOLKSWAGEN	June 15-Oct '21	Caddy All gen 3, (2K Facelift)	Rear	⊖ ⊖
23991	RENAULT	08-12	Logan sedan (U90)	Rear	⊥ ○
23991	RENAULT	09-Feb'14	Sandero hatch 302 Stepway) (B90 / BS gen 1)	Rear	⊥ ○
23992	MAZDA	04-09	Mazda 3 gen 1 (BK) 302 MPS, sport susp or AWD (51mm btm sleeve length)	Rear	⊥ ⊖
25504	CITROEN	05-Oct '10	C4 (Gen 1) 1.6i, 2.0i, 2.0Hdi 100 Coupe 302 DS4 & sport susp)	Rear	⊥ ○
25504	PEUGEOT	02-10	 (S/W) 307 1.6 & 2.0 hatch & 2.0 S/Wagon 302 cc)	Rear	⊥ ⊖
26635	BMW	88-95	5 Series (E34) EXCL Sport Susp, M Tech & M5) Note: See the INFO column for front shock selection details. Check OE #'s	Rear	⊗ ⊖
26635	BMW	Mid 90 - 95	5 Series (E34) Std. & Sport Susp EXCL M Tech & M5) Note: See the INFO column for front shock selection details. Check OE numbers	Rear	⊗ ⊖
26654	AUDI	Feb'99-Nov'00	 A4 Quattro & Sport Quattro 302 S4) B5, 8D	Front	⊥ ⊗
26654	AUDI	Feb'99-Nov'00	 A4 Avant Quattro 302 S4 & Sport suspension)	Front	⊥ ⊗
26654	AUDI	97-Jan'99	A6 Sedan & Avant 302 2.7 Turbo, Quattro, Allroad & 4.2 V8) Only up to -> chassis No's 4B#X#070 000	Front	⊥ ⊗
26654	AUDI	97-Jan'99	A6 Quattro sedan & Avant S/W 302 2.7 turbo, Allroad & 4.2 V8) Only up to -> chassis No's 4B#X#070 000	Front	⊥ ⊗
26655	AUDI	May'00-March '04	A6 Sedan & Avant 302 Quattro, Allroad, 8cyl & Air Susp) From Ch# : 4B#1#000 001 -on	Front	⊥ ⊗
26655	AUDI	May'00-May'01	A6 Quattro sedan & Avant 302 Allroad & 4.2 V8)	Front	⊥ ⊗
26663	AUDI	June'01 - '04	A6 Quattro Sedan & Avant 302 All Road & 4.2 V8)	Front	⊥ ⊗
26663	VOLKSWAGEN	99-05	 Passat Sedan EXCL S/W, Sport Susp & 4WD 4 Motion Syncro) (B5)	Front	⊥ ⊗

Key

*	See important installation information on inside front cover
!	Excluding self-levelling suspension
***	Special order - phone 010 900 1850. 6-12 week waiting period

~	Imported
#	Internal bump stop
⊖	Steering damper

- It is recommended that all new shock absorbers are fitted in pairs
- Do not mix gas and non-gas units on the same axle
- **Bold** part numbers indicate heavy-duty shocks
- Underlined part numbers indicate parts not immediately available
- *Italic* part numbers followed by > indicate parts to be discontinued

Passenger and light commercial

Part number [numerical listing]

Part number	Make	Year	Application	Position	Mounting information
26663	VOLKSWAGEN	99-05	 Passat Sedan 2.3 V5 & 2.8 4WD 4 Motion Syncro (EXC) Sport Susp) (B5)	Front	⊥ ⊗
<u>26669</u>	PEUGEOT	Mid 04-10	407 Sedan 2.0 ST (EXC) elec susp)	Front	⊥ ○
<u>26670</u>	PEUGEOT	Mid 04-10	407 Sedan 2.0 Hdi, 2.2 ST Sport, 3.0 ST (EXC) Coupe & elec susp)	Front	⊥ ○
<u>26670</u>	PEUGEOT	End 04-08	407 S/Wagon 2.0 Hdi, 2.2 Sport, 3.0 Sport (EXC) elec susp)	Front	⊥ ○
<u>26671</u>	PEUGEOT	Mid 04-10	407 Sedan 2.0 ST (EXC) elec susp)	Rear	⊥ ○
<u>26671</u>	PEUGEOT	Mid 04-10	407 Sedan 2.0 Hdi, 2.2 ST Sport, 3.0 ST (EXC) Coupe & elec susp)	Rear	⊥ ○
<u>26671</u>	PEUGEOT	End 04-08	407 S/Wagon 2.0 Hdi, 2.2 Sport, 3.0 Sport (EXC) elec susp)	Rear	⊥ ○
37026	JEEP	97-06	Jeep Wrangler 4x4 (TJ series) (INC) Sport (EXC) Rubicon) Std Height	Front	⊥ ⊕
37027	JEEP	91-01	Jeep Cherokee 4x4 (INC) Sport, Limited & Country (XJ) Std ht	Rear	⊕ ○
<u>37081</u>	JEEP	93-98	Jeep Grand Cherokee All (ZJ series) ((INC) Up- country Susp) Std Height	Front	⊥ ⊕
<u>37082</u>	JEEP	93-98	Jeep Grand Cherokee All (ZJ series) ((INC) Up- country Susp) Std Height	Rear	○ ⊕
37083	JEEP	91-01	Jeep Cherokee 4x4 (INC) Sport, Limited & Country (XJ) Std ht	Front	⊥ ⊕
37135	JEEP	97-06	Jeep Wrangler 4x4 (TJ series) (INC) Sport (EXC) Rubicon) Std Height	Rear	⊕ ⊕
<u>37161</u>	JEEP	99-5/05	Jeep Grand Cherokee All (WJ series) ((INC) Up country susp) Std Height	Front	⊥ ⊕
<u>37162</u>	JEEP	99-5/05	Jeep Grand Cherokee All (WJ series) ((INC) Up country susp) Std Height	Rear	⊕ ⊕
37203	DODGE	07-11	Nitro SUV AWD	Rear	⊕ ⊕
37203	JEEP	02-07	Jeep Cherokee 4x4 (KJ)	Rear	⊕ ⊕
37203	JEEP	08-13	Jeep Cherokee 4x4 (KK)	Rear	⊕ ⊕
42022	DATSUN	75-80	 140GX, 160GX, 140Z & 160Z Coupe	Rear	⊥ ○
42022	TOYOTA	82-88	 Corolla S/Wagon & Panelvan R.W.D (KE71, KE72, KE73)	Rear	⊥ ○
42022	TOYOTA	73-79	Corolla Van (Imported Strut)	Rear	⊥ ○
42022	TOYOTA	79-88	Corolla Van	Rear	⊥ ○
42022	TOYOTA	Mid'81-85	Cressida S/Wagon	Rear	⊥ ○
42022	TOYOTA	86-92	Cressida S/Wagon	Rear	⊥ ○
42041	CITROEN	01-05	Xsara II	Rear	○ ○
42041	PEUGEOT	98-02	306 Hatch, 1.6 Sedan and S/Wagon	Rear	⊕ ⊕
42041	PEUGEOT	93-97	 306 CC Cabrio	Rear	⊕ ⊕
42041	PEUGEOT	97-2/04	 306 CC Cabrio	Rear	⊕ ⊕
43009	MERCEDES-BENZ	77-86	W123 200, 230, 240D, 250, 280E, 300D (EXC) S/W	Front	⊥ ⊗
43009	MERCEDES-BENZ	73-81	280S, 280E, 280SE, 350SE & 450SE (INC) SEL (116 Series)	Front	⊥ ⊗
43009	MERCEDES-BENZ	81-93	280SE, 300SE, 380SE, 420SE, 500SE & 560SE (INC) SEL & SEC (W126).	Front	⊥ ⊗
43009	MERCEDES-BENZ	81-92	380SEC, 420SEC, 500SEC, 560SEC (C126)	Front	⊥ ⊗
43013	JAGUAR	69-86 (XJ12 till '93)	XJ6 & XJ 12 ((INC) 4.2 & 2.8 & Daimler double six up to '93)	Rear	⊕ ⊕
43013	JAGUAR	75-96	XJS & XJSC	Rear	⊕ ⊕
43027	JAGUAR	69-86 (XJ12 till '93)	XJ6 & XJ 12 ((INC) 4.2 & 2.8 & Daimler double six up to '93)	Front	⊥ ⊕
43027	JAGUAR	75-96	XJS & XJSC	Front	⊥ ⊕
43071	MERCEDES-BENZ	83-94	190E (INC) Sportline (201 Series)	Rear	⊥ ⊕
43071	MERCEDES-BENZ	86-95	W124 (EXC) E420, E500 (INC) all CE models C124 coupes, (EXC) Self leveling susp, S/W, Sportline & V124 limo (W124)	Rear	⊥ ⊕
43080	MERCEDES-BENZ	94- Aug '00	C180, C200, C220, C230 & C240 (EXC) C250Td, C280, Sport susp & S/Wagon) (W202)	Front	⊥ ⊕
43081	MERCEDES-BENZ	94- Aug '00	C180, C200, C220, C230 & C240 (EXC) C250Td, C280, Sport susp & S/Wagon) (W202)	Rear	⊥ ⊕
43081	MERCEDES-BENZ	94- Aug '00	C250td & C280 (EXC) Sport susp S/Wagons) (W202)	Rear	⊥ ⊕
43089	MERCEDES-BENZ	94- Aug '00	C250td & C280 (EXC) Sport susp S/Wagons) (W202)	Front	⊥ ⊕

Key

*	See important installation information on inside front cover
!	Excluding self-leveling suspension
"..."	Special order - phone 010 900 1850. 6-12 week waiting period

~	Imported
#	Internal bump stop
⊕	Steering damper

- It is recommended that all new shock absorbers are fitted in pairs
- Do not mix gas and non-gas units on the same axle
- **Bold** part numbers indicate heavy-duty shocks
- Underlined part numbers indicate parts not immediately available
- *Italic* part numbers followed by > indicate parts to be discontinued

Passenger and light commercial

Part number [numerical listing]

Part number	Make	Year	Application	Position	Mounting information
43089	MERCEDES-BENZ	94 - Aug '01	S/Wagon, 301 Sport susp (W202)	Front	⊥ ⊕
43093	RENAULT	95-'02	 Megane Hatch 2.0 16v 301 Sedan)	Rear	⊕ ⊕
43093	RENAULT	96-May04	Megane Coupe 301 2.0 16v)	Rear	⊕ ⊕
43093	RENAULT	96-May04	Megane Coupe 2.0 16v	Rear	⊕ ⊕
43095	RENAULT	95-'02	  Megane Hatch & '96-'03 Classic Sedan 301 2.0 16v)	Rear	⊕ ⊕
43095	RENAULT	97 - May'04	Megane Cabriolet 301 2.0 16v)	Rear	⊕ ⊕
43096	MERCEDES-BENZ	95-July'02	W210 E200, E240, E280, E320 & E430 Std. Susp. (301 S/W, E230 & E270CDi, Sport & Elec susp)	Front	⊥ ⊕
43096	MERCEDES-BENZ	95-July'02	W210 E230 & E270CDi, Std. Susp (301 S/W & Elec susp)	Front	⊥ ⊕
43096	MERCEDES-BENZ	96-July02	T210 S/Wagon E320T, std susp	Front	⊥ ⊕
43097	MERCEDES-BENZ	95-July'02	W210 E200, E240, E280, E320 & E430 Std. Susp. (301 S/W, E230 & E270CDi, Sport & Elec susp)	Rear	⊥ ⊕
43104	CITROEN	96-02	Berlingo Multispace MPV & P/Van	Rear	⊙ ⊙
43104	CITROEN	03-April '08	Berlingo Multispace MPV & P/Van	Rear	⊙ ⊙
43104	PEUGEOT	99-Nov'02	Partner Grand Raid MPV 2.0 Hdi (DW10TD) gen 1 (600kg payload) (5F)	Rear	⊕ ⊕
43104	PEUGEOT	Nov'02-08	Partner Grand Raid MPV 1.9D (DW8B) & 2.0 Hdi (DW10TD) gen 1 (600kg payload) (5F)	Rear	⊕ ⊕
43104	PEUGEOT	99-11/02	Partner Panel Van 1.9D gen 1 (800kg payload)	Rear	⊕ ⊕
43104	PEUGEOT	11/02-08	Partner Panel Van 1.9D gen 1 (800kg payload)	Rear	⊕ ⊕
43107	RENAULT	June'04-08	Kangoo 1 Multix 1.4 MPV people carrier (580kg payload, 2 rear torsion bars) (301 4x4)	Rear	⊕ ⊕
43109	PEUGEOT	00-12	206 1.4, 1.6 XS, 1.6 XT, 2.0 HDi & 20 Gti Hatch (2A/C)	Rear	⊕ ⊕
43109	PEUGEOT	02-12	206 S/Wagon 1.6	Rear	⊕ ⊕
43109	PEUGEOT	02-5/07	206 Cabrio cc	Rear	⊕ ⊕
43112	MERCEDES-BENZ	00-04	A160, A170CDi A190 (W168)	Rear	⊙ ⊙
43114	CITROEN	01-07	Xsara Picasso MPV	Rear	⊙ ⊙
43125	FORD	04-Oct '08	 Fiesta Sedan & Hatch Mk 5 JH, JD 101 2.0ST (301 2.5 ST or RS)	Rear	⊥ ⊕
43125	FORD	10-Nov 15	Figo Hatch 1.4 gen 1	Rear	⊥ ⊕
43125	FORD	07-15	Ikon sedan All	Rear	⊥ ⊕
43130	MERCEDES-BENZ	05-12	A170, A180CDi, A200 (W169)	Rear	⊥ ⊙
43130	MERCEDES-BENZ	06-March '12	B170, B200T, B200CDi (W245)	Rear	⊥ ⊙
43136	MERCEDES-BENZ	12-Aug 18	A180, A200, A200d, A220d, A250 (W176) 301 AMG & Sport susp	Rear	⊥ ⊕
43136	MERCEDES-BENZ	April '12-18	B180, B200, B200d, B220d, B250 (W246)	Rear	⊥ ⊕
43136	MERCEDES-BENZ	13-19	CLA200, CLA200d, CLA220d, CLA250 (C117) 101 Sport susp, 301 Incr ground clearance, AMG & Elec susp	Rear	⊥ ⊕
43136	MERCEDES-BENZ	14-19	GLA200, GLA200d, GLA220d, GLA250, 301 elec susp & AMG gen 1 (X156)	Rear	⊥ ⊕
43137	MERCEDES-BENZ	Aug '02-09	W211 E200K, E220 Cdi, E240, E270CDi, E280, E320, E350, E500, E320CDi (301 S/Wagon, AMG & Elec & air susp)	Front	⊥ ⊗
43137	MERCEDES-BENZ	Aug '02-mid 09	S211 S/Wagon E200K, E220 Cdi, E280, E320CDi, E350, E500 (301 AMG & Elec & air susp)	Front	⊥ ⊗
43138	MERCEDES-BENZ	Sept'00-April '07	C180, C180K, C200, C200K, C220Cdi, C230, C230K, C240, C280, C320Cdi, C350 & C270CDi (W203) 101 S/Wagon (C203) (301 AMG, Coupe & Sports susp)	Rear	⊥ ⊕
43138	MERCEDES-BENZ	02 - 09	 CLK320, CLK350 & CLK500 Cabriolet (A209) (301 Sport & AMG)	Rear	⊥ ⊕
43139	MERCEDES-BENZ	Aug '02-09	W211 E200K, E220 Cdi, E240, E270CDi, E280, E320, E350, E500, E320CDi - Std susp (301 S/Wagon, AMG & Elec & air susp)	Rear	⊥ ⊕
44001	FORD	Nov'08-Oct '12	 Fiesta Sedan & Hatch Mk 6 CB1, CCN (101 1.6 ST)	Rear	⊥ ⊕
44001	MAZDA	07-Feb'15	Mazda 2 (DE)	Rear	⊥ ⊙
45008	AUDI	97-Jan'99	A6 Sedan & Avant (101 2.7 Turbo, Quattro, Allroad & 4.2 V8)	Rear	⊥ ⊕
45008	AUDI	Feb'99-April '00	A6 Sedan & Avant S/W (301 Quattro, Allroad & 8cyl) 101 2.7 Turbo From chassis No's 4B#X#070 000 -> 4B#Y#200 000	Rear	⊥ ⊕
45008	AUDI	May'00-March '04	A6 Sedan & Avant (301 Quattro, Allroad, 8cyl & Air Susp) From Ch# : 4B#1#000 001 -on	Rear	⊥ ⊕

Key



























*	See important installation information on inside front cover
!	Excluding self-levelling suspension
"..."	Special order - phone 010 900 1850. 6-12 week waiting period

~	Imported
#	Internal bump stop
⊕	Steering damper

- It is recommended that all new shock absorbers are fitted in pairs
- Do not mix gas and non-gas units on the same axle
- **Bold** part numbers indicate heavy-duty shocks
- Underlined part numbers indicate parts not immediately available
- *Italic* part numbers followed by > indicate parts to be discontinued

Passenger and light commercial

Part number [numerical listing]

Part number	Make	Year	Application	Position	Mounting information
45008	VOLKSWAGEN	99-05	 Passat Sedan (EXC S/W, Sport Susp & 4WD 4 Motion Syncro) (B5)	Rear	⊥ ○
45009	ALFA ROMEO	June'01-10	147 1.6TS, 1.9JTD & 2.0TS hatch	Front	⊥ ⊗
45009	ALFA ROMEO	97-05	156 ALL (EXC GTA, Sport susp)	Front	⊥ / ⊗
45009	ALFA ROMEO	00-06	156 Sportwagon (EXC GTA / elec susp / self leveling rears)	Front	⊥ / ⊗
45009	ALFA ROMEO	05-10	2.0 & 1.9JTD & 3.2 V6 GTA	Front	⊥ / ⊗
45009	ALFA ROMEO	97-05	156 GTA & Sport Susp (EXC 3.2 GTA)	Front	⊥ / ⊗
53005	MERCEDES-BENZ	68-77	220, 230, 240 & 280E (114, 115 Series)	Rear	⊥ ⊕
53005	MERCEDES-BENZ	77-86	W123 200, 230, 240D, 250, 280E, 300D (EXC S/W)	Rear	⊥ ⊕
53005	MERCEDES-BENZ	73-81	280S, 280E, 280SE, 350SE & 450SE (EXC SEL (116 Series)	Rear	⊥ ⊕
53005	MERCEDES-BENZ	81-93	280SE, 300SE, 380SE, 420SE, 500SE & 560SE (EXC SEL & SEC (W126).	Rear	⊥ ⊕
53005	MERCEDES-BENZ	81-92	380SEC, 420SEC, 500SEC, 560SEC (C126)	Rear	⊥ ⊕
53005	MERCEDES-BENZ	71-89	280SL & SLC, 350SL & SLC, 380SL & SLC, 450SL & SLC, 500SL EXC elec or self leveling susp (R107) (C107)	Rear	⊥ ⊕
71380	HONDA	02-06	CR-V 4x4 2.0, 2.2 Gen 2 (RD4 – RDB) (Models EXC Xenon headlights – Check for rear shock bracket)	Rear	⊥ ⊕
71572	CHRYSLER	01-07	Voyager 2.0 & 2.4 SWB; & Grand Voyager 2.8, 3.3 V6 & 2.5TD LWB (EXC Rear Nivomat leveling susp & AWD 4x4)	Front	
71964	CHRYSLER	95-00	Voyager 2.0 SWB & Grand Voyager (GS) 3.3 V6 & 2.5 TD LWB (EXC Rear Nivomat leveling susp & 4x4)	Front	
10049 R 10050 L	HYUNDAI	94-May 97	 Accent I (X3)	Rear	
11261 R 11260 L	MAZDA	Mid 81-85	323 F.W.D (BD 5th gen)	Rear	
11290 > R 11291 > L	DAEWOO	97-'03	Nubira I & II (EXC S/W (EXC ABS) (J100)	Rear	
11290 > R 11291 > L	DAEWOO	97-'03	Nubira I & II (EXC S/W & with ABS brakes (J100)	Rear	
11339 R 11340 L	HYUNDAI	July'00-05	 Accent II (LC)	Front	
11377 R 11378 L	CHEVROLET	03-05	Spark (M100, M150)	Front	
11377 R 11378 L	DAEWOO	99-03	Matiz hatch M100	Front	
11377 R 11378 L	CHERY	08-on	QQ3 (S11) 0.8, 1.1	Front	
11456 > R 11457 > L	DAEWOO	97-'03	Nubira I & II (EXC S/W & with ABS brakes (J100)	Front	
11744 > R 11745 > L	DAEWOO	97-'03	Nubira I & II (EXC S/W (EXC ABS) (J100)	Front	
11753 R 11754 L	PEUGEOT	95-'04	 406 Sedan (EXC elec susp)	Front	
11753 R 11754 L	PEUGEOT	96-'04	(S/W) 406 2.0 Estate S/Wagon (EXC elec susp)	Front	
11753 R 11754 L	PEUGEOT	97-Feb'06	 406 Coupe 3.0 (EXC elec susp)	Front	
150734R >	DAIHATSU	05-'16	Sirion 1.3 & 1.5 hatch 4x2, EXC 4x4 (M300) – Cross border = Boon	Rear	○ ○
150734R >	DAIHATSU	05-'16	Sirion 1.3 & 1.5 hatch gen 2 4x2, EXC 4x4 (M600) – Cross border = Boon	Rear	○ ○
150863R >	HONDA	May'11-Aug '16	 Civic Sedan Mk9 (FB, FG)	Rear	⊥ ⊕
16244 R 16245 L	HYUNDAI	96- Aug '00	Elantra Sedan & S/W gen 2 (J2)	Front	
16244 R 16245 L	HYUNDAI	97- 02	Tiburon coupe (RD)	Front	
16282 R 16283 L	FORD	00-Oct '04	Focus 2.0 & ST170 Hatch and Sedan MkI	Front	
16361 R 16362 L	HYUNDAI	02-10	Matrix Mini MPV (FC)	Front	
16381 R 16382 L	FIAT	04-10	Panda 1.2, 1.3 (EXC AWD & 1.4 100HP) (169)	Front	
16411 R 16412 L	MAZDA	Mid 99-03	626 sedan (GF) [assembled in Zimbabwe]	Front	

Key

*	See important installation information on inside front cover
!	Excluding self-leveling suspension
...	Special order – phone 010 900 1850. 6-12 week waiting period

~	Imported
#	Internal bump stop
⊕	Steering damper

- It is recommended that all new shock absorbers are fitted in pairs
- Do not mix gas and non-gas units on the same axle
- **Bold** part numbers indicate heavy-duty shocks
- Underlined part numbers indicate parts not immediately available
- *Italic* part numbers followed by > indicate parts to be discontinued

Passenger and light commercial

Part number [numerical listing]

Part number	Make	Year	Application	Position	Mounting information
16411 R 16412 L	MAZDA	Mid 99-03	(S/W) 626 S/W (GW) [assembled in Zimbabwe]	Front	
16471 R 16472 L	HONDA	March '01-05	Civic Vtec 4 door Sedan (ES) Mk7	Front	
16471 R 16472 L	HONDA	March '01-05	Civic Vtec 5 door hatch (EP, EU) Mk7 1.3, 1.4, 1.5, 1.6, 1.7i	Front	
16508 >	MITSUBISHI	83-86	Tredia Sedan M Turbo	Front	
16688 R 16689 L	VOLVO	95- May'99	S40 Sedan & V40 S/W EXC Sport & T4	Front	
16734 >	HYUNDAI	94-98	Sonata (Y3) gen 3	Front	
16796 R 16797 L	VOLVO	April '00-May'04	S40 Sedan & V40 S/W EXC Sport & T4	Front	
16798 R 16799 L	VOLVO	April '00-Late'04	S40 Sedan & V40 S/W T4	Front	
16820 R 16821 L	TOYOTA	96-01	Export Camry (Japan mnf) SXV20, MCV20, XV20 gen 5	Front	
23468 >	BMW	99 – Sept'01	318i & 320d (E46) EXC M3, cabrio, coupe, & sport susp)	Rear	
23468 >	BMW	99 – Sept'01	320i, 323i, 325i & 328i (E46) EXC M3, cabrio, coupe & sport susp)	Rear	
23468 >	BMW	Sept'01- Feb'05	318i (E46) EXC Compact, M3, cabrio, coupe, sport susp & S/W)	Rear	
23468 >	BMW	Sept'01- Feb'05	320i, 320d, 325i (E46) EXC Compact, M3, cabrio, coupe & sport susp)	Rear	
23787 R 23788 L	HONDA	92-95	Ballade All M local Encore & CRX EXC those with rear bottom U brackets) Mk5 SR4 or EG	Front	
23787 R 23788 L	HONDA	92-95	Ballade All M imported Encore & CRX (With rear bottom U brackets) Mk5 EG or EH	Front	
23829 >	VOLVO	95- May'99	S40 Sedan & V40 S/W T4 and Sportline	Rear	
23829 >	VOLVO	June'99-April '00	S40 Sedan & V40 S/W T4	Rear	
23919 >	BMW	00-06	330Ci Cabriolet EXC Sport Pac II & M3) (E46)	Rear	
23919 >	BMW	99-06	325Ci, 330Ci Coupe EXC Sport Pac II & M3) (E46)	Rear	
25485 >	FIAT	02-10	Palio Weekend S/Wagon Type PY & 1Y + gen 2 Type 2G & 2K 1.4	Rear	
350861R R > 350862R L >	HONDA	May'11-Aug '16	Civic Sedan Mk9 (FB, FG)	Front	
37272ST	GWM	08-11	H3 Hover4x2 & 4x4 SUV	Rear	
37272ST	GWM	11-16	H5 SUV (X240)	Rear	
37272ST	KIA	04 – April '07	Sedona MPV gen 1 (GQ / KV)	Rear	
37289ST	TOYOTA	March '06 -12	RAV4 (XA30) gen 3	Rear	
37289ST	TOYOTA	13-Feb 19	RAV4 (XA40) gen 4	Rear	
37290ST	CHRYSLER	08-16	All Voyager; and Grand Voyager EXC self leveling systems)	Rear	
37310ST	MITSUBISHI	June '07-'12	Outlander 2.4 SUV (Gen 2, GS platform) CW5W M '10-'12 Facelift models – (no S/Pan)	Rear	
37310ST	PEUGEOT	09-10	4007 SUV (VU, VW)	Rear	
37313ST	MAZDA	07-12	CX-7 SUV (crossover) 4x4	Rear	
37323ST	KIA	07-Oct '09	Sorento 4x4 & 4x2 2.5 & 3.8 gen 1 (JC) EXC elec or self-leveling susp	Rear	
37345ST	FORD	13-23	Tourneo Connect 5 & 7 seater minivan & Transit Connect compact minivan (gen 2 – V408, P65, P70, P80) FWD	Rear	
37358ST >	JEEP	14-21	Jeep Cherokee 4x2 EXC Trailhawk (KL)	Rear	
37361ST >	LEXUS	10-15	RX 350, 450h 4x4 EXC air susp gen 3 (AL10)	Rear	
37382ST	HONDA	Aug17-23	CR-V 4x4 1.5T, 2.0 Gen 5 (RW)	Rear	
376000SP	AUDI	11 – Sept '18	Q3 2.0TDI, 2.0T 4x2 & 4x4 Quattro EXC RS 2.5 sport or elec susp) 8U	Rear	
376003SP >	BMW	99 – Sept'01	318i & 320d (E46) EXC M3, cabrio, coupe, & sport susp)	Rear	
376003SP >	BMW	99 – Sept'01	320i, 323i, 325i & 328i (E46) EXC M3, cabrio, coupe & sport susp)	Rear	
376003SP >	BMW	99- April '01	330i & 330d (E46) EXC M3, cabrio, coupe & sport)	Rear	

Key









*	See important installation information on inside front cover
!	Excluding self-levelling suspension
"..."	Special order – phone 010 900 1850. 6-12 week waiting period

~	Imported
#	Internal bump stop
⊕	Steering damper

- It is recommended that all new shock absorbers are fitted in pairs
- Do not mix gas and non-gas units on the same axle
- **Bold** part numbers indicate heavy-duty shocks
- Underlined part numbers indicate parts not immediately available
- *Italic* part numbers followed by > indicate parts to be discontinued

Passenger and light commercial

Part number [numerical listing]

Part number	Make	Year	Application	Position	Mounting information
376003SP >	BMW	Sept'01- Feb'05	318i (E46) EXCI Compact, M3, cabrio, coupe, sport susp & S/W)	Rear	⊗ ⊖
376003SP >	BMW	Sept'01- Feb'05	320i, 320d, 325i (E46) EXCI Compact, M3, cabrio, coupe & sport susp)	Rear	⊗ ⊖
376003SP >	BMW	April '01- Feb'05	330i & 330d (E46) INCL 325ti compact EXCI M3, cabrio, coupe, sport susp & S/W)	Rear	⊗ ⊖
376003SP >	BMW	98-05	E46 – Sport Pack II for BMW OE Sport Susp INCL Ci	Rear	⊗ ⊖
376003SP >	BMW	Nov'01-05	318ti Compact (E46) INCL Sport susp	Rear	⊗ ⊖
376003SP >	BMW	Nov'01-05	325ti Compact (E46) INCL Sport susp	Rear	⊗ ⊖
376003SP >	BMW	00-05	318i, 320i, 325i Touring (E46) EXCI Sport susp)	Rear	⊗ ⊖
376003SP >	BMW	00-06	 330Ci Cabriolet EXCI Sport Pac II & M3) (E46)	Rear	⊗ ⊖
376003SP >	BMW	99-06	 325Ci, 330Ci Coupe EXCI Sport Pac II & M3) (E46)	Rear	⊗ ⊖
376003SP >	BMW	00-06	 325Ci, 330 Ci Coupe Sport Pac II EXCI M3) (E46)	Rear	⊗ ⊖
376006SP >	AUDI	Dec '00- 04	 +  A4 Sedan & Avant + Quattro EXCI Sport Susp, S4, & RS4) B6, 8E	Front	⊥ ⊗
376006SP >	AUDI	05-07	 (S/W) A4 INCL Quattro, Avant & Allroad EXCI Sport susp, S4 & RS4) B7	Front	⊥ ⊗
376014SP	BMW	June'10-16	All F10 5 Series sedan INCL Sport susp & M-Tech EXCI GT liftback, F11 Touring S/W, elec susp & M5)	Rear	⊥ ⊖
376015SP	BMW	June'10-16	All F07 Gran Turismo GT 5 Series Liftback EXCI Sedan, F11 Touring S/W, xDrive & M5)	Rear	⊥ ⊖
376020SP	BMW	97- '03	5 Series Touring S/W EXCI 540i and Sport susp)	Rear	⊗ ⊖
376021SP >	BMW	91-99	316i, 318i, 318is, 318tds, 320i, 323i, 325i, 325td, 325tds, 328i Imported & Local Strut. INCL Cabrio. EXCI M. Tech). (E36)	Rear	⊗ ⊖
376021SP >	BMW	91-92	320i, 325i & 325td Imported EXCI M. Tech. (E36)	Rear	⊗ ⊖
376021SP >	BMW	93-99	 323i, 325i & 328i Cabriolet EXCI M Tech) (E36)	Rear	⊗ ⊖
376024SP	AUDI	July'04-11	A6 Sedan & Avant INCL Quattro EXCI Air susp) C6 Typ 4F	Front	⊥ ⊗
376025SP	AUDI	11-19	A6 Sedan & Avant INCL Quattro EXCI Air & Elec susp) C7 Typ 4G	Rear	⊥ ⊖
376025SP	AUDI	11-early '18	A7 Sportback INCL Quattro EXCI Air or elec susp, and S7 or RS7 4.0 V8) 4G8	Rear	⊥ ⊖
376027SP >	AUDI	May'03-12	A3 all INCL Sportback EXCI Quattro, Sport Susp & S3) OE Strut leg bottom outer diam = 50mm	Rear	⊥ ⊖
376027SP >	AUDI	May'03-12	A3 all INCL Sportback EXCI Quattro, Sport Susp & S3) OE Strut leg bottom outer diam = 50mm OE Strut leg bottom outer diam = 55mm	Rear	⊥ ⊖
376027SP >	AUDI	May'03-12	A3 & S3 Quattro and sport suspension 2.0 & 3.2 : 55mm OD strut only EXCI S3 front & all RS3)	Rear	⊥ ⊖
376028SP >	AUDI	Feb'99-Nov'00	 A4 Quattro & Sport Quattro EXCI S4) B5, 8D	Front	⊥ ⊗
376028SP >	AUDI	Feb'99-Nov'00	 A4 Avant EXCI Sport susp, sedan & Quattro) B5, 8D	Front	⊥ ⊗
376028SP >	AUDI	Feb'99-Nov'00	 A4 Avant Quattro EXCI S4 & Sport suspension)	Front	⊥ ⊗
376028SP >	AUDI	97-Jan'99	A6 Sedan & Avant EXCI 2.7 Turbo, Quattro, Allroad & 4.2 V8) Only up to -> chassis No's 4B#X#070 000	Front	⊥ ⊗
376028SP >	AUDI	97-Jan'99	A6 Quattro sedan & Avant S/W EXCI 2.7 turbo, Allroad & 4.2 V8) Only up to -> chassis No's 4B#X#070 000	Front	⊥ ⊗
376029SP	BMW	Nov'03-May'10	All E60 5 Series sedan EXCI Touring S/W, M5 & Sport susp)	Rear	⊥ ⊖
376030SP >	AUDI	May'00-March '04	A6 Sedan & Avant EXCI Quattro, Allroad, 8cyl & Air Susp) From Ch# : 4B#1#000 001 -on	Front	⊥ ⊗
376030SP >	AUDI	May'00-May'01	A6 Quattro sedan & Avant EXCI Allroad & 4.2 V8)	Front	⊥ ⊗
376032SP	BMW	97- '03	Z3 1.8, 1.9, 2.8 & 3.0 (E36) EXCI M-tech & M Coupe	Rear	⊥ ⊖
376033SP	BMW	96- '03	520i, 523i, 525i, 528i, 530d & 530i (E39) EXCI 535i, 540i, Sport susp, M5, Air Susp, M Tech, Elec susp & S/W)	Rear	⊗ ⊖
376033SP	BMW	96- '03	535i & 540i (E39) EXCI "protection", M5, Air Susp, M Tech, Sport susp, Elec susp & S/W)	Rear	⊗ ⊖
376035SP >	MERCEDES-BENZ	Aug '02-09	W211 E200K, E220 Cdi, E240, E270CDi, E280, E320, E350, E500, E320CDi EXCI S/Wagon, AMG & Elec & air susp)	Front	⊥ ⊗
376035SP >	MERCEDES-BENZ	Aug '02-mid 09	S211 S/Wagon E200K, E220 Cdi, E280, E320CDi, E350, E500 EXCI AMG & Elec & air susp)	Front	⊥ ⊗
376039SP	MERCEDES-BENZ	5/07-May'14	C180, C200, C220Cdi, C230, C250, C250Cdi, C280, C300, C320Cdi, C350Cdi & C350 EXCI elec susp, Self level susp, AMG, Coupe, 4-Matic & Sports susp)	Rear	⊥ ⊖
376040SP	MERCEDES-BENZ	Sept'00-April '07	W203 Sport Suspension EXCI AMG	Rear	⊥ ⊖
376040SP	MERCEDES-BENZ	00-11	CLC203 Sport Suspension EXCI AMG	Rear	⊥ ⊖

Key

*	See important installation information on inside front cover
!	Excluding self-leveling suspension
...	Special order – phone 010 900 1850. 6-12 week waiting period

~	Imported
#	Internal bump stop
⊕	Steering damper

- It is recommended that all new shock absorbers are fitted in pairs
- Do not mix gas and non-gas units on the same axle
- **Bold** part numbers indicate heavy-duty shocks
- Underlined part numbers indicate parts not immediately available
- *Italic* part numbers followed by > indicate parts to be discontinued

Passenger and light commercial

Part number [numerical listing]

Part number	Make	Year	Application	Position	Mounting information
376042SP	AUDI	08-Jan '16	A5 Sportback Coupe, Cabrio & Quattro (EXC) Sport Susp, S5 & RS5) (8T, B8)	Front	⊥ ⊗
376042SP	AUDI	08-Jan 16	S5 Sportback Coupe & Cabrio (INT) A5 Sport Susp, Quattro (EXC) RS5 4.2 V8 (8T)	Front	⊥ ⊗
376042SP	AUDI	08-Jan 16	  A4 Sedan & Avant Sport Susp, (INT) Quattro (EXC) S4 & Elec susp) B8	Front	⊥ ⊗
376042SP	AUDI	08-Jan 16	  A4 Sedan & Avant (EXC) Sport susp, Quattro, Elec susp & S4) B8	Front	⊥ ⊗
376045SP	MERCEDES-BENZ	00-11	C180K, C200K, C230K and CLC200K, CLC350 (CLC203) (EXC) Sport susp & AMG	Rear	⊥ ⊖
376047SP	MERCEDES-BENZ	Mid 09-April '16	W212 E200, E250, E250CDi, E300, E350, E400, E500 (EXC) S/W, Coupe, Cabrio, AMG, sport susp, air susp, elec susp & AWD)	Rear	⊥ ⊖
376048SP	AUDI	08 - 17	Q5 4x4 Quattro (EXC) sport susp) Typ 8R	Rear	⊥ ⊖
376049SP	AUDI	08 - 17	Q5 4x4 Quattro (EXC) sport susp) Typ 8R	Front	⊥ ⊗
376051SP	MERCEDES-BENZ	Mid 04 - July 11	SLK200K, SLK350 (EXC) AMG (R171)	Rear	⊥ ⊖
376054SP >	AUDI	June '01 - '04	A6 Quattro Sedan & Avant (EXC) All Road & 4.2 V8)	Front	⊥ ⊗
376054SP >	VOLKSWAGEN	99-05	 Passat Sedan (EXC) S/W, Sport Susp & 4WD 4 Motion Syncro) (B5)	Front	⊥ ⊗
376054SP >	VOLKSWAGEN	99-05	 Passat Sedan 2.3 V5 & 2.8 4WD 4 Motion Syncro (EXC) Sport Susp) (B5)	Front	⊥ ⊗
376055SP >	AUDI	99-April '03	A3 Quattro (INT) Sport Susp)	Rear	⊖ ⊖
376055SP >	AUDI	00-April '03	S3 Quattro (EXC) sport)	Rear	⊖ ⊖
376055SP >	AUDI	00-06	TT 1.8 Turbo Coupe & Roadster/Cabriolet (8N) Quattro (EXC) Sport Susp	Rear	⊖ ⊖
376057SP >	AUDI	96- Jan'99	 A4 Avant (EXC) Quattro, Sport) 8D, B5	Rear	⊥ ⊖
376058SP >	AUDI	Feb'99-April '00	A6 Quattro sedan & Avant (EXC) 2.7 turbo, Allroad & 4.2 V8) From chassis No's 4B#X#070 000 -> 4B#Y#200 000	Rear	⊥ ⊖
376058SP >	AUDI	97-April '00	A6 2.7 Quattro Turbo, (EXC) Allroad 4WD & 4.2 V8) Up to -> chassis No's 4B#Y#200 000	Rear	⊥ ⊖
376058SP >	VOLKSWAGEN	99-05	 Passat Sedan 2.3 V5 & 2.8 4WD 4 Motion Syncro (EXC) Sport Susp) (B5)	Rear	⊥ ⊖
376058SP >	AUDI	97-Jan'99	A6 Quattro sedan & Avant S/W (EXC) 2.7 turbo, Allroad & 4.2 V8) Only up to -> chassis No's 4B#X#070 000	Rear	⊥ ⊖
376063SP >	VOLKSWAGEN	08-Sept 16	Tiguan 4 Motion AWD & FWD (INT) Blue Motion (EXC) elec susp) gen 1 (5N)	Rear	⊥ ⊖
376072SP	MERCEDES-BENZ	April '02-09	 CLK320, CLK350 & CLK500 Coupe (C209) (EXC) Sport & AMG)	Rear	⊥ ⊖
376073SP	JAGUAR	99-08	S-Type (X200) (EXC) elec susp	Rear	⊥ ⊖
376076SP	JAGUAR	99-08	S-Type (X200) (EXC) elec susp	Front	⊥ ⊖
376077SP >	BMW	98-05	E46 - Sport Pack II for BMW OE Sport Susp (INT) Ci	Rear	⊗ ⊖
376077SP >	BMW	00-06	 325Ci, 330 Ci Coupe Sport Pac II (EXC) M3) (E46)	Rear	⊗ ⊖
376081SP >	AUDI	97-April '00	A6 Sedan & Avant (INT) 2.7 Turbo, Quattro, Allroad & 4.2 V8)	Rear	⊥ ⊖
376081SP >	AUDI	May'00-March '04	A6 Sedan & Avant (EXC) Quattro, Allroad, 8cyl & Air Susp) From Ch# : 4B#1#000 001 -on	Rear	⊥ ⊖
376081SP >	AUDI	Feb'99-April '00	A6 Sedan & Avant S/W (EXC) Quattro, Allroad & 8cyl) (INT) 2.7 Turbo From chassis No's 4B#X#070 000 -> 4B#Y#200 000	Rear	⊥ ⊖
376081SP >	VOLKSWAGEN	99-05	 Passat Sedan (EXC) S/W, Sport Susp & 4WD 4 Motion Syncro) (B5)	Rear	⊥ ⊖
376085SP >	CITROEN	05-Oct '10	C4 (Gen 1) 1.6i, 2.0i, 2.0HDi (INT) Coupe (EXC) DS4 & sport susp)	Rear	⊥ ⊖
376098SP	VOLVO	02-July'15	XC90 AWD 2.4D, 3.2, 4.4 V8 Cross Country S/Wagon gen 1 (EXC) Elec or self lev susp)	Rear	⊥ ⊖
376099SP >	VOLKSWAGEN	07-15	Eos Cabriolet	Rear	⊥ ⊖
376099SP >	VOLKSWAGEN	04-Feb'09	Golf V Gti & R32 (INT) 4 Motion AWD	Rear	⊥ ⊖
376099SP >	VOLKSWAGEN	March '09-13	Golf VI Gti & R32 (INT) 4 Motion AWD (EXC) elec susp	Rear	⊥ ⊖
376099SP >	VOLKSWAGEN	March '06-Sept'11	Jetta V (EXC) V5 & Sport susp) 1K2 (A5). Strut leg bottom outer diam = 50mm	Rear	⊥ ⊖
376099SP >	VOLKSWAGEN	09-17	Scirocco (EXC) elec, R or sport susp (137)	Rear	⊥ ⊖
376101SP >	OPEL	July '05-10	Zafira 1.6, 1.8, 1.9CDTi MPV (Exc OPC, Sport & Panoramic) (B)	Rear	⊖ ⊖
376102SP >	OPEL	01-05	Zafira 1.6, 1.8, 1.9CDTi, 2.2 MPV (EXC) 2.0 turbo & OPC) (A)	Rear	⊖ ⊖
376104SP >	AUDI	97-April '00	A6 2.7 Turbo (EXC) Quattro, Allroad & 8 cyl) Up to -> chassis No's 4B#Y#200 000	Front	⊥ ⊗
376104SP >	AUDI	Feb'99-April '00	A6 Sedan & Avant S/W (EXC) Quattro, Allroad & 8cyl) (INT) 2.7 Turbo From chassis No's 4B#X#070 000 -> 4B#Y#200 000	Front	⊥ ⊗

Key

*	See important installation information on inside front cover
!	Excluding self-levelling suspension
"..."	Special order - phone 010 900 1850. 6-12 week waiting period

~	Imported
#	Internal bump stop
⊖	Steering damper

- It is recommended that all new shock absorbers are fitted in pairs
- Do not mix gas and non-gas units on the same axle
- **Bold** part numbers indicate heavy-duty shocks
- Underlined part numbers indicate parts not immediately available
- *Italic* part numbers followed by > indicate parts to be discontinued

Passenger and light commercial

Part number [numerical listing]

Part number	Make	Year	Application	Position	Mounting information
376104SP >	AUDI	Feb'99-April '00	A6 Quattro sedan & Avant (EXC) 2.7 turbo, Allroad & 4.2 V8) From chassis No's 4B#X#070 000 -> 4B#Y#200 000	Front	⊥ ⊗
376104SP >	AUDI	97-April '00	A6 2.7 Quattro Turbo, (EXC) Allroad 4WD & 4.2 V8) Up to -> chassis No's 4B#Y#200 000	Front	⊥ ⊗
376113SP	FORD	11-12	Kuga 4x2 & 4x4 SUV (gen 1) C394	Rear	⊥ ○
376130SP >	CHEVROLET	11-18	Sonic sedan & hatch 1.4 & 1.6 (T300) (EXC) RS 1.4 Turbo	Rear	⊥ ○
376135SP	OPEL	10-17	Meriva 1.4 mini MPV (B)	Rear	⊖ ⊖
376136SP	PEUGEOT	13-19	2008 Crossover SUV 1.2T, 1.6 gen 1 (CU / A94)	Rear	⊖ ⊖
376151SP ! >	PEUGEOT	09-17	3008 MPV Crossover 1.6, 1.6 T, 2.0 Hdi gen 1 (EXC) self leveling susp) (T8 / OU)	Rear	⊥ ⊖
376155SP >	CITROEN	Nov'10-16	C4 (Gen 2) 1.6i, 2.0, 2.0 HDi (EXC) DS4 & sport susp)	Rear	⊥ ○
376157SP	VOLVO	09-Sept 18	XC60 AWD Cross Country SUV gen 1 (EXC) elec & self leveling susp	Rear	⊥ ⊖
376162SP >	RENAULT	01-07	Laguna II All, (EXC) S/Wagon (X74)	Rear	⊖ ⊖
376166SP >	PEUGEOT	02-5/07	206 Cabrio cc	Rear	⊖ ⊖
376183SP >	PEUGEOT	Mid 04-10	407 Sedan 2.0 ST (EXC) elec susp)	Front	⊥ ○
376185SP >	HONDA	96- March '01	Ballade & Civic (EXC) Vtec (With rear bottom U brackets) (EJ9, EK1, EK3, EK4) Mk6	Rear	⊥ ⊗
376193SP	AUDI	Late '12-20	A3 all Gen 3 (8V) (EXC) Sportback, Quattro, Sport Susp (EXC) S3 & Elec susp) 11mm rod & 45mm btm sleeve OE Strut leg outer diam = 50mm	Rear	⊥ ⊖
376193SP	VOLKSWAGEN	13-19	Golf VII (EXC) Gti (EXC) V5, R, AWD & Sport susp) (5G) (EXC) elec susp) OE Strut leg outer diam = 55mm, 11mm rod & 45mm btm sleeve /	Rear	⊥ ⊖
376193SP	VOLKSWAGEN	15-17	Golf SV (Sportsvan) MPV (EXC) elec susp) 11mm rod & 45mm btm sleeve /	Rear	⊥ ⊖
376194SP	AUDI	Late '12-20	A3 all Gen 3 (8V) (EXC) Sportback, Quattro, Sport Susp (EXC) S3 & Elec susp) 13mm rod & 45mm btm sleeve OE Strut leg outer diam = 55mm	Rear	⊥ ⊖
376194SP	VOLKSWAGEN	13-19	Golf VII (EXC) Gti (EXC) V5, R, AWD & Sport susp) (5G) (EXC) elec susp) OE Strut leg outer diam = 55mm 13mm rod & 45mm btm sleeve /	Rear	⊥ ⊖
376194SP	VOLKSWAGEN	15-17	Golf SV (Sportsvan) MPV (EXC) elec susp) 13mm rod & 45mm btm sleeve /	Rear	⊥ ⊖
376195SP	AUDI	Late '12-20	A3 all Gen 3 (8V) (EXC) Sportback, Quattro, Sport Susp (EXC) S3 & Elec susp) 13mm rod & 59mm btm sleeve OE Strut leg outer diam = 55mm	Rear	⊥ ⊖
376195SP	AUDI	12-on	A3 Cabriolet (EXC) Quattro Gen 3 (8V) 13mm rod & 59mm btm sleeve	Rear	⊥ ⊖
376195SP	VOLKSWAGEN	13-19	Golf VII (EXC) Gti (EXC) V5, R, AWD & Sport susp) (5G) (EXC) elec susp) OE Strut leg outer diam = 55mm 13mm rod & 59mm btm sleeve	Rear	⊥ ⊖
376195SP	VOLKSWAGEN	15-17	Golf SV (Sportsvan) MPV (EXC) elec susp) 13mm rod & 59mm btm sleeve	Rear	⊥ ⊖
376210SP >	BMW	Nov'11-19	1 series 116i,118i, 120i, 125i & 120d (EXC) Sport Susp, Elec susp, x-Drive, 135i, M135i & M140i)	Rear	⊥ ○
376211SP	BMW	Nov'11-19	1 series 116i,118i, 120i, 125i & 120d (EXC) Sport Susp, Elec susp, x-Drive, 135i, M135i & M140i)	Rear	⊥ ○
376211SP	BMW	Nov'11-19	1 series Sport Susp (EXC) 135i, Elec susp, x-Drive, M135i & M140i)	Rear	⊥ ○
376211SP	BMW	April '14-on	2 Series 220i, 228i, 230i, 220d (EXC) elec susp, 235i, M235i, M240i, M2 & Sport Susp)	Rear	⊥ ⊖
376211SP	BMW	13- Feb 18	 3 Series F30 sedan (EXC) GT Gran Turismo 5 door liftback/hatch, S/W, Sport susp, Elec Susp, X-Drive and M series) Gen 6	Rear	⊥ ○
376211SP	BMW	13- Feb 18	 3 Series F30 sedan Sport Susp & F31 S/W std & Sport (EXC) GT Gran Turismo 5 door liftback/hatch, and M series) Gen 6	Rear	⊥ ○
376211SP	BMW	13-on	F34 Gran Turismo GT 3 series 5 door liftback/hatch Std susp (EXC) Sedan, S/Wagon, Sport susp and M series)	Rear	⊥ ○
376211SP	BMW	13-on	4 Series Coupe, Gran Coupe (liftback) SDrive (EXC) (EXC) F33 Cabrio, Sport susp, M4, Elec susp & Grand Coupe XDrive)	Rear	⊥ ○
376212SP	BMW	Nov'11-19	1 series 135i Sport Susp Only (EXC) elec susp, x-Drive, M135i & M140i)	Rear	⊥ ○
376212SP	BMW	April '14-on	2 Series Sport Susp (EXC) elec susp & M2)	Rear	⊥ ⊖
376212SP	BMW	13-on	F34 Gran Turismo GT 3 series 5 door liftback/hatch Sport susp (EXC) Sedan, S/Wagon and M series)	Rear	⊥ ○
376212SP	BMW	13-on	4 Series Coupe, Gran Coupe (liftback) & (EXC) F33 Cabriolet Sport susp SDrive (EXC) elec susp, XDrive & M4)	Rear	⊥ ○
376212SP	BMW	13-on	M4 Coupe, Cabriolet & GTS (EXC) Xdrive	Rear	⊥ ○
376213SP	AUDI	July'04-11	A6 Sedan & Avant (EXC) Quattro (EXC) Air susp) C6 Typ 4F	Rear	⊥ ⊖
376219SP (EXC) 376220SP (EXC)	BMW	June'10-16	All F10 5 Series sedan (EXC) Sport susp & M-Tech (EXC) GT liftback, F11 Touring S/W, elec susp & M5)	Front	⊥ ⊗

Key

*	See important installation information on inside front cover
!	Excluding self-leveling suspension
...	Special order – phone 010 900 1850. 6-12 week waiting period

~	Imported
#	Internal bump stop
⊖	Steering damper

- It is recommended that all new shock absorbers are fitted in pairs
- Do not mix gas and non-gas units on the same axle
- **Bold** part numbers indicate heavy-duty shocks
- Underlined part numbers indicate parts not immediately available
- *Italic* part numbers followed by > indicate parts to be discontinued

Passenger and light commercial

Part number [numerical listing]

Part number	Make	Year	Application	Position	Mounting information
376228SP !	AUDI	07-March '15	TT 1.8T, 2.0T, 3.2 V6 Coupe & Roadster/Cabriolet, INC1 Quattro & Sport susp (8J) EXC1 elec susp & 2.5RS Quattro (8J)	Rear	⊥ ⊕
376230SP >	VOLKSWAGEN	99-05	Golf IV 1.6 Estate S/Wagon	Rear	⊥ ⊕
376230SP >	VOLKSWAGEN	00-05	Golf IV 1.9 Tdi Estate S/Wagon	Rear	⊥ ⊕
376232SP >	AUDI	Feb'99-Nov'00	 A4 Sedan EXC1 Sport susp, Avant S/W & Quattro) B5, 8D	Rear	⊥ ⊕
376234SP >	FORD	Nov'04-July'11	Focus 1.6, 1.6Si, 1.8TDCi, 2.0, 2.0Si, 2.0TDCi & TDCi Si, INC1 2.5 ST front only, Hatch and Sedan MkII DA, DP EXC1 2.5 ST rear & RS)	Rear	⊥ ⊕
376234SP >	FORD	15-early18	Focus Hatch and Sedan MkIII C346 Including facelift models EXC1 2.0ST rear, RS)	Rear	⊥ ⊕
376240SP	VOLKSWAGEN	Oct '12-17	New Beetle (Type 2 / A5) 55mm front strut body rod OD: 13mm rod & 37mm btm eye sleeve	Rear	⊥ ⊕
376241SP	VOLKSWAGEN	Oct '12-17	New Beetle (Type 2 / A5) 50mm front strut body, rod OD: 11mm rod & 45mm btm eye sleeve	Rear	⊥ ⊕
376243SP	AUDI	11-19	A6 Sedan & Avant INC1 Quattro EXC1 Air & Elec susp) C7 Typ 4G	Front	⊥ ⊗
376244SP	AUDI	11-early '18	A7 Sportback INC1 Quattro EXC1 Air or elec susp, and S7 or RS7 4.0 V8) 4G8	Front	⊥ ⊗
376246SP	AUDI	Oct 18 - on	Q3 1.4, 2.0 4x2 & 4x4 Quattro EXC1 RS 2.5 sport or elec susp) F3	Rear	⊥ ⊕
376246SP	VOLKSWAGEN	18-22	Arteon 4 door Sport coupe (3H7) Std suspension	Rear	⊥ ⊕
376246SP	VOLKSWAGEN	Sept'15-19	Passat sedan EXC1 elec susp) (B8)	Rear	⊥ ⊕
376246SP	VOLKSWAGEN	Oct 16-23	Tiguan 4 Motion AWD & FWD 1.4TSi, 2.0 Tdi, 2.0TSi gen 2 INC1 Allspace 7 seater (AD, BW) EXC1 electronic suspension	Rear	⊥ ⊕
376248SP	AUDI	Feb 16-on	 A4 Sedan INC1 Quattro (8W) Sport susp EXC1 S4) B9 (48mm btm mtng housing diam)	Rear	⊥ ⊕
376248SP	AUDI	Feb '16 - on	A5 Sportback Coupe, Cabrio & Quattro INC1 sport susp EXC1 RS5) (F5, B9)	Rear	⊥ ⊕
376248SP	AUDI	Feb 16 - on	S5 Sportback Coupe & Cabrio INC1 A5 Sport Susp, Quattro EXC1 RS5 4.2 V8 (B9)	Rear	⊥ ⊕
376249SP	OPEL	Nov'15-19	Corsa Hatch 1.0T, 1.4 INC1 1.4 Turbo Sport (E)	Rear	⊥ ⊕
376252SP	HYUNDAI	April 16-22	Tucson All (TL) gen 3	Rear	⊥ ⊕
376252SP	KIA	April '16 - Sept 22	Sportage 4x2 1.6Gdi Gen 4 (QL)	Rear	⊥ ⊕
376252SP	KIA	April '16 - Sept 22	Sportage 4x4 2.0, 2.4 Gen 4 (QL)	Rear	⊥ ⊕
376255SP	AUDI	Feb 16-on	 A4 Sedan INC1 Quattro (8W) EXC1 Sport susp & S4) B9 (53mm btm mtng housing diam)	Front	⊥ ⊗
376255SP (53mm housing)	AUDI	Feb '16 - on	A5 Sportback Coupe, Cabrio & Quattro EXC1 RS5) (F5, B9)	Front	⊥ ⊗
376255SP (53mm housing)	AUDI	Feb 16 - on	S5 Sportback Coupe & Cabrio INC1 A5 Sport Susp, Quattro EXC1 RS5 4.2 V8 (B9)	Front	⊥ ⊗
376256SP	OPEL	June 16-21	  Astra EXC1 OPC, Coupe, Sports or Elec susp) B16 (K)	Rear	⊥ ⊕
376259SP	SUZUKI	April '14-17	SX4 1.6 4x2 & 4x4 S-Cross SUV (JY)	Rear	⊥ ⊕
376259SP	SUZUKI	15-on	Vitara 4x4 1.4T, 1.6 gen 4 (LY)	Rear	⊥ ⊕
376260SP	BMW	April '14-17	2 Series Active Tourer MPV 218i, 220i, 225i, 220d EXC1 MTech & Sport Susp)	Rear	⊥ ⊕
376260SP	BMW	Nov 15-Oct 22	X1 (F48) sDrive FWD & xDrive AWD 1.8i, 2.0i, 2.0d EXC1 LWB F49)	Rear	⊥ ⊕
376260SP	BMW	Nov 18-on	X2 (F39) 1.8i, 2.0i sDrive FWD & 2.0d xDrive AWD	Rear	⊥ ⊕
376263SP >	MERCEDES-BENZ	June'14-June '21	W205 C class C180, C200, C220d, C250, C250d, C300 & C350e EXC1 S/Wagon, Elec susp, Self level susp, Coupe, 4-Matic, AMG & Sports susp)	Rear	⊥ ⊕
376263SP >	MERCEDES-BENZ	End '14-June '21	C Class Coupe and Cabrio EXC1 Sport susp & AMG)	Rear	⊥ ⊕
376264SP	OPEL	18-on	Grandland & Grandland X 1,6T SUV (A18)	Rear	⊥ ⊕
376264SP	PEUGEOT	17-on	3008 MPV 1.2T, 1.6T, 2.0 Hdi Crossover gen 2 EXC1 self leveling susp) (P84 / MC, MR, MJ, M4)	Rear	⊥ ⊕
376264SP	PEUGEOT	17-on	5008 1.6T MPV gen 2 (P87, MC, MJ, MR, M4)	Rear	⊥ ⊕
376268SP	MINI	14-24	Mini One, Cooper (F56 - 3 door, F55 - 5 door Mk III) INC1 cabriolet (F57) & sport EXC1 JCW GP sport)	Rear	⊥ ⊕
376269SP	MINI	15-24	Mini Clubman S/Wagon INC1 sport (F54) mkII	Rear	⊥ ⊕
376269SP	MINI	April 17-on	Mini Countryman SUV Crossover INC1 AWD (F60) mkII	Rear	⊥ ⊕
376270SP	MERCEDES-BENZ	15-22	GLC220d, GLC250, GLC250d, GLC300, GLC350 EXC1 Coupe, Elec susp & AMG gen 1 (X253)	Rear	⊥ ⊕
376270SP	MERCEDES-BENZ	15-22	 Coupe GLC220d, GLC250, GLC250d, GLC300, GLC350. EXC1 5 door, Elec susp & AMG gen 1 (C253)	Rear	⊥ ⊕

Key













*	See important installation information on inside front cover
!	Excluding self-levelling suspension
"..."	Special order - phone 010 900 1850. 6-12 week waiting period

~	Imported
#	Internal bump stop
⊕	Steering damper

- It is recommended that all new shock absorbers are fitted in pairs
- Do not mix gas and non-gas units on the same axle
- **Bold** part numbers indicate heavy-duty shocks
- Underlined part numbers indicate parts not immediately available
- *Italic* part numbers followed by > indicate parts to be discontinued

Passenger and light commercial

Part number [numerical listing]

Part number	Make	Year	Application	Position	Mounting information
376274SP	MERCEDES-BENZ	June '14-June '21	W205 C class C180, C200, C220d, C250, C250d, C300 & C350e EXC S/Wagon, Elec susp, Self level susp, Coupe, 4-Matic, AMG & Sports susp)	Front	⊥ ⊗
376274SP	MERCEDES-BENZ	End '14-June '21	C Class Coupe C180, C200, C220d, C250, C250CDi, C300, C350 EXC Sport susp & AMG)	Front	⊥ ⊗
376274SP	MERCEDES-BENZ	End '14-June '21	C Class Cabrio C200, C220d, C300 EXC Sport susp & AMG)	Front	⊥ ⊗
376277SP	AUDI	17 - 23	Q2 (35) 1.0, 1.4 (GAB & GAG)	Rear	⊥ ⊖
376277SP	VOLKSWAGEN	20-on	T-Roc SUV EXC electronic susp (A11)	Rear	⊥ ⊖
378003SP	TOYOTA	12-on	Avanza 1.3, 1.5 MPV & Panel Van EXC ABS (F650) Gen 2 EXC facelift	Rear	⊖ ⊖
378047SP	HONDA	12-19	Amaze sedan gen 1 (DF1, DF2)	Rear	⊥ ⊖
378047SP	HONDA	12-19	Brio hatch gen 1 (DD1, DD2)	Rear	⊥ ⊖
379024SP	FIAT	05-16	Strada 3/4 ton LDV Pickup: 1.2, 1.4, 1.6, 1.7TD	Rear	⊖ ⊖
<i>53015</i> >	MERCEDES-BENZ	93-mid99	300SE, 400SE, 500SE, (all EXC SEL) & S320, S430, S500 (W140) EXC Limo	Rear	⊥ ⊖
<i>53015</i> >	MERCEDES-BENZ	93 - 99	CL500, CL600 (C140) EXC elec susp	Rear	⊥ ⊖
<u>5515ST</u>	MAZDA	13-16	Mazda 6 EXC MPS gen 3 (6J)	Rear	⊥ ⊖
5530ST	MAZDA	12-14	CX-5 SUV gen 1 (KE)	Rear	⊥ ⊖
<i>5532ST</i> >	NISSAN	14-17	Sentra 1.6 (B17 Sytphy / Pulsar)	Rear	⊥ ⊖
5540ST	MAZDA	Oct '14-June 19	Mazda 3 gen 3 (BM) EXC MPS, sport susp or AWD	Rear	⊥ ⊖
<u>5546ST</u>	MAZDA	14-17	CX-5 SUV gen 1 facelift (KE)	Rear	⊥ ⊖
5607ST	MAZDA	99-04	Premacy (Cross border) Gen 1 	Rear	⊥ ⊖
5607ST	MAZDA	05-10	Mazda 5 MPV Gen 2 (CR19)	Rear	⊥ ⊖
5607ST	MAZDA	11-15	Mazda 5 MPV Gen 3 (CW)	Rear	⊥ ⊖
5609ST	HONDA	06-April '11	 Civic 1.8 Sedan Mk8 (FD, FA)	Rear	⊥ ⊖
5609ST	HONDA	May '11-Aug '16	 Civic Sedan Mk9 (FB, FG)	Rear	⊥ ⊖
<i>5614ST</i> >	HYUNDAI	10/05-9/10	Sonata (NF) gen 5	Rear	⊥ ⊖
5621ST	HYUNDAI	06-July 11	  Accent III (MC)	Rear	⊥ ○
5621ST	KIA	March '06-Oct '11	Rio 1.4, 1.6 gen 2 (JB)	Rear	⊥ ○
5622ST	HYUNDAI	Nov '06-July '11	Elantra Sedan gen 4 (HD)	Rear	⊥ ⊗
5646ST	HYUNDAI	10/10-early '15	Sonata (YF) gen 6	Rear	⊥ ⊗
5646ST	KIA	11-14	Optima 2.4 sedan (TF)	Rear	⊥ ⊗
5657ST	KIA	09-14	Soul hatch 1.6 (AM)	Rear	⊖ ⊖
<i>5667ST</i> >	FORD	15-17	Fusion sedan (gen2)	Rear	⊥ ⊖
<i>5671ST</i> >	KIA	13-18	Cerato / Forte sedan, hatch & Koup (YD) gen 2	Rear	⊖ ⊖
<i>5671ST</i> >	HYUNDAI	13-17	Veloster 3 door coupe (FS)	Rear	⊖ ⊖
5794ST	CHEVROLET	03-11	Aveo gen one & two (T200 & T250 facelift)	Rear	⊥ ○
<i>5799ST</i> >	KIA	03-Feb '06	Rio 1.3, 1.5 gen 1 facelift (DC) EXC earlier models	Rear	⊖ ⊖
58648ST	CHRYSLER	08-16	All Voyager; and Grand Voyager(EXC self leveling systems)	Rear	⊖ ⊖
71128ST	CHRYSLER	08-16	All Voyager; and Grand Voyager (Check for Rear Nivomat self leveling susp)	Front	
71147ST	MITSUBISHI	June '04 -May '07	Outlander 2.0, 2.4 SUV (Gen 1) CU2W, CU5W	Rear	⊥ ⊖
71354ST	SUBARU	00-04	  Legacy III 2.0 & 2.5 4x4 (EXC Air susp, 3.0 & Outback) (BE/BH)	Rear	⊥ ⊖
71377ST	JEEP	07-09	Commander 3.0, 4.7 & 5.6 (XK)	Front	
71377ST	JEEP	6/05 - 2/11	Jeep Grand Cherokee All (WK series) EXC up country / raised susp) EXC SRT8	Front	
<u>71406ST</u> R <u>71407ST</u> I	HYUNDAI	Aug '00-Oct '06	Elantra Sedan & S/W gen 3 (XD)	Rear	
<i>71410</i> > R <i>71411</i> > I	SUBARU	98 - May '02	Forester 1 AWD 2.0 & 2.5 (EXC Self leveling, elec or air susp) (SF gen 1)	Rear	

Key





























































































*	See important installation information on inside front cover
!	Excluding self-leveling suspension
"..."	Special order - phone 010 900 1850. 6-12 week waiting period

~	Imported
#	Internal bump stop
⊖	Steering damper

- It is recommended that all new shock absorbers are fitted in pairs
- Do not mix gas and non-gas units on the same axle
- **Bold** part numbers indicate heavy-duty shocks
- Underlined part numbers indicate parts not immediately available
- *Italic* part numbers followed by > indicate parts to be discontinued

Passenger and light commercial

Part number [numerical listing]

Part number	Make	Year	Application	Position	Mounting information
71435  71436 	HYUNDAI	01-06	Santa Fe 4x2 & 4x4 Gen 1 (SM)	Front	
71577ST	DODGE	07-11	Nitro SUV AWD	Front	
71577ST	JEEP	02-07	Jeep Cherokee 4x4 (KJ)	Front	
71577ST	JEEP	08-13	Jeep Cherokee 4x4 (KK)	Front	
72118ST >  72119ST > 	TOYOTA	00-03	Prius Hybrid (NHW10, XW10, NHW10, NHW11) gen 1	Front	
72143ST  72144ST 	HONDA	02-06	CR-V 4x4 2.0, 2.2 Gen 2 (RD4 – RD8) (Models with Xenon headlights – Check for rear shock bracket)	Front	
72170ST  72171ST > 	KIA	99-04	Carnival MPV (KV-II / UP) gen 1	Front	
72170ST >  72171ST > 	KIA	04 – April '07	Sedona MPV gen 1 (GQ / KV)	Front	
72193ST >  72194ST > 	HYUNDAI	02-08	Tiburon Coupe (GK)	Rear	
72219ST  72220ST 	HYUNDAI	04 – 10	Tucson All (JM) gen 1	Front	
72219ST  72220ST 	KIA	Oct '04-Sept'10	Sportage 4x4 & 4x2 Gen 2 (JE / KM)	Front	
72221  72222 	HYUNDAI	04 – 10	Tucson All (JM) gen 1	Rear	
72221  72222 	KIA	Oct '04-Sept'10	Sportage 4x4 & 4x2 Gen 2 (JE / KM)	Rear	
72263ST  72264ST 	MAZDA	05-10	Mazda 5 MPV Gen 2 (CR19)	Front	
72263ST  72264ST 	MAZDA	11-15	Mazda 5 MPV Gen 3 (CW)	Front	
72267ST >  72268ST > 	NISSAN	05-end 08	Murano 3.5 V6 4x4 SUV gen 1 (Z50)	Front	
72275ST >  72276ST > 	TOYOTA	March '06 -12	RAV4 (XA30) gen 3	Front	
72275ST >  72276ST > 	TOYOTA	13-Feb 19	RAV4 (XA40) gen 4	Front	
72281ST	HYUNDAI	06-11	Azera sedan 3.3 V6 (TG)	Front	
72281ST >	HYUNDAI	10/05-9/10	Sonata (NF) gen 5	Front	
72286ST  72287ST 	HONDA	06-April '11	 Civic 1.8 Sedan Mk8 (FD, FA)	Front	
72297ST  72298ST 	HYUNDAI	06-July'11	  Accent III (MC)	Front	
72297STR 72298ST 	KIA	March '06-Oct '11	Rio 1.4, 1.6 gen 2 (JB)	Front	
72305ST >  72306ST > 	HYUNDAI	Nov'06-July'11	Elantra Sedan gen 4 (HD)	Front	
72367ST  72368ST 	DODGE	06-12	Caliber 1.8, 2.0 & 2.4 cross-over hatch	Front	
72367ST  72368ST 	JEEP	07-10	Compass (MK) gen1	Front	
72367ST  72368ST 	JEEP	07-10	Patriot 4x4 (MK)	Front	
72401ST	DODGE	06-12	Caliber 1.8, 2.0 & 2.4 cross-over hatch	Rear	
72401ST	JEEP	07-10	Compass (MK) gen1	Rear	
72401ST	JEEP	07-10	Patriot 4x4 (MK)	Rear	
72418ST	NISSAN	03 -May'04	Outlander 2.0, 2.4 SUV (Gen 1) CU2W, CU5W	Front	
72418ST	NISSAN	June'04 -May'07	Outlander 2.0, 2.4 SUV (Gen 1) CU2W, CU5W	Front	
72425ST >  72426ST > 	SUBARU	05 – 08	Forester 2 AWD 2.5  Self leveling, elec or air susp) (SG gen 2)	Front	
72437ST  72438ST 	NISSAN	June '07-'12	Outlander 2.4 SUV (Gen 2, GS platform) CW5W  '10-'12 Facelift models	Front	
72437ST  72438ST 	PEUGEOT	09-10	4007 SUV (VU, WV)	Front	
72491ST  72492ST 	HONDA	07-12	CR-V 4x4 2.0, 2.2, 2.4 Gen 3 (RE) (Models with Xenon headlights – Check for rear shock bracket)	Front	

Key



































































































*	See important installation information on inside front cover
!	Excluding self-levelling suspension
"..."	Special order – phone 010 900 1850. 6-12 week waiting period

~	Imported
#	Internal bump stop
⊕	Steering damper

- It is recommended that all new shock absorbers are fitted in pairs
- Do not mix gas and non-gas units on the same axle
- **Bold** part numbers indicate heavy-duty shocks
- Underlined part numbers indicate parts not immediately available
- *Italic* part numbers followed by > indicate parts to be discontinued



Passenger and light commercial

Part number [numerical listing]

Part number	Make	Year	Application	Position	Mounting information
72491ST  72492ST 	HONDA	End 12-14	CR-V 4x4 2.0, 2.2, 2.4 Gen 4 (RM)	Front	
72491ST  72492ST 	HONDA	End 15-July17	CR-V 4x4 2.0, 2.2, 2.4 Gen 4 (RM) facelift	Front	
72493ST  72494ST 	MAZDA	07-12	CX-7 SUV (crossover) 4x4	Front	
72497ST	HONDA	07-12	CR-V 4x4 2.0, 2.2, 2.4 Gen 3 (RE) (Models  Xenon headlights – Check no rear shock bracket)	Rear	
72509ST  72510ST 	DODGE	08-'11	Journey MPV (JC49)  self leveling susp	Front	
72509ST  72510ST 	DODGE	11-'17	Journey MPV (JC49 facelift)  self leveling susp	Front	
72511ST	DODGE	08-'11	Journey MPV (JC49)  self leveling susp	Rear	
72522ST  72523ST 	FORD	Aug '11-15	Focus 1.0, 1.5, 1.6, 2.0Si, 2.0TDCi & TDCi Si,  2.0ST front only, Hatch and Sedan MKIII C346 ( 2.0ST rear, RS, & facelift models)	Front	
72546ST	JEEP	3/11-15	Jeep Grand Cherokee All (WK2 series)  2013 facelift,  SRT8, Air susp, elec or self-leveling susp. ('11-'15  stabiliser bar bracket)	Front	
72562ST	HONDA	09-12	Accord Sedan & S/W 8th Gen (CU)	Front	
72562ST	HONDA	09-12	Accord Sedan & S/W ( ABS) 8th Gen (CU)	Front	
72563ST	HONDA	09-12	Accord Sedan & S/W 8th Gen (CU)	Rear	
72563ST	HONDA	09-12	Accord Sedan & S/W ( ABS) 8th Gen (CU)	Rear	
72638ST >	FORD	15-17	Fusion sedan (gen2)	Front	
72643IMM	HONDA	02-06	CR-V 4x4 2.0, 2.2 Gen 2 (RD4 – RD8) (Models with Xenon headlights – Check for rear shock bracket)	Rear	
72643IMM	HONDA	07-12	CR-V 4x4 2.0, 2.2, 2.4 Gen 3 (RE) (Models with Xenon headlights – Check for rear shock bracket)	Rear	
72686ST >  72687ST > 	SUBARU	10-12	Legacy Outback 2.5, 3.0 AWD (BR) gen 4  Self leveling or elec susp	Front	
72706ST  72707ST 	HYUNDAI	Aug '11-20	  Accent IV i25 (RB)	Front	
72708ST  72709ST 	HYUNDAI	Aug '11-June '16	Elantra Sedan gen 5 (MD)	Front	
72787ST  72788ST 	FORD	13-23	Tourneo Connect 5 & 7 seater minivan & Transit Connect compact minivan (gen 2 – V408, P65, P70, P80) FWD	Front	
72896ST 	DODGE	11-'17	Journey MPV (JC49 facelift)  self leveling susp	Rear	
72930ST  72931ST 	JEEP	14-18	Jeep Cherokee 4x2  Trailhawk (KL)	Front	
72938ST  72939ST 	MAZDA	13-16	Mazda 6  MPS gen 3 (GJ)	Front	
72947ST >  72948ST > 	NISSAN	2013	Sentra 1.6 (B17 Sylphy / Pulsar)	Front	
72947ST >  72948ST > 	NISSAN	14-17	Sentra 1.6 (B17 Sylphy / Pulsar)	Front	
72950ST  72951ST 	JEEP	11-16	Compass (MK2) gen 1 Facelift	Front	
72950ST  72951ST 	JEEP	11-18	Patriot (MK2) (Facelift)	Front	
72952ST	JEEP	11-16	Compass (MK2) gen 1 Facelift	Rear	
72952ST	JEEP	11-18	Patriot (MK2) (Facelift)	Rear	
72957ST	HONDA	End 12-14	CR-V 4x4 2.0, 2.2, 2.4 Gen 4 (RM)	Rear	
72957ST	HONDA	End 15-July17	CR-V 4x4 2.0, 2.2, 2.4 Gen 4 (RM) facelift	Rear	
72968ST  72969ST 	KIA	09-14	Soul hatch 1.6 (AM)	Front	
72978ST  72979ST 	MAZDA	12-14	CX-5 SUV gen 1 (KE)	Front	
72978ST  72979ST 	MAZDA	14-17	CX-5 SUV gen 1 facelift (KE)	Front	
73015ST  73016ST 	MAZDA	Oct '14-June 19	Mazda 3 gen 3 (BM)  MPS, sport susp or AWD	Front	
73039ST >	SUBARU	13-14	Legacy Outback 2.5, 3.0 AWD (BR) gen 4 facelift  Self leveling or elec susp	Rear	
73045ST  73046ST 	HONDA	End 15-July17	CR-V 4x4 2.0, 2.2, 2.4 Gen 4 (RM) facelift	Front	

Key



































































































































	See important installation information on inside front cover
	Excluding self-leveling suspension
	Special order – phone 010 900 1850. 6-12 week waiting period

	Imported
	Internal bump stop
	Steering damper

- It is recommended that all new shock absorbers are fitted in pairs
- Do not mix gas and non-gas units on the same axle
- **Bold** part numbers indicate heavy-duty shocks
- Underlined part numbers indicate parts not immediately available
- *Italic* part numbers followed by > indicate parts to be discontinued



Passenger and light commercial

Part number [numerical listing]

Part number	Make	Year	Application	Position	Mounting information
73077ST  73078ST 	JEEP	16-21	Jeep Grand Cherokee All (WK2 series)  2013 facelift.  SRT8, Air susp, elec or self-leveling susp. ('16-'21  stabiliser bar bracket)	Front	 
73097ST  73098ST 	HONDA	Aug17-23	CR-V 4x4 1.5T, 2.0 Gen 5 (RW)	Front	
742000SP >	AUDI	11 - Sept '18	Q3 2.0TDi, 2.0T 4x2 & 4x4 Quattro  RS 2.5 sport or elec susp) 8U	Front	
742001SP >	MERCEDES-BENZ	Sept'00-April '07	C180, C180K, C200, C200K, C220Cdi, C230, C230K, C240, C280, C320Cdi, C350 & C270CDI (W203)  S/Wagon (C203)  AMG, Coupe & Sports susp)	Front	
742001SP >	MERCEDES-BENZ	April '02-09	 CLK320, CLK350 & CLK500 Coupe (C209)  Sport & AMG)	Front	
742001SP >	MERCEDES-BENZ	02 - 09	 CLK320, CLK350 & CLK500 Cabriolet (A209)  Sport & AMG)	Front	
742002SP	MERCEDES-BENZ	00-11	C180K, C200K, C230K and CLC200K, CLC350 (CLC203)  Sport susp & AMG	Front	
742003SP	MERCEDES-BENZ	Sept'00-April '07	W203 Sport Suspension  AMG	Front	
742003SP	MERCEDES-BENZ	00-11	CLC203 Sport Suspension  AMG	Front	
742004SP  > 742005SP  >	BMW	00-05	318i Touring (E46)  Sport susp)	Front	
742004SP  > 742005SP  >	BMW	99 - Sept'01	318i & 320d (E46)  M3, cabrio, coupe, & sport susp)	Front	
742008SP >  742009SP > 	BMW	Nov'01-05	318ti Compact (E46)  Sport susp	Front	
742008SP >  742009SP > 	BMW	Sept'01- Feb'05	318i (E46)  Compact, M3, cabrio, coupe, sport susp & S/W)	Front	
742010SP >  742011SP > 	BMW	Sept'01- Feb'05	320i, 320d, 325i (E46)  Compact, M3, cabrio, coupe & sport susp)	Front	
742010SP >  742011SP > 	BMW	99-Sept'01	 325Ci, 330Ci Coupe  Sport Pac II & M3) (E46)	Front	
742012SP >  742013SP > 	BMW	April '01- Feb'05	330i & 330d (E46)  325ti compact  M3, cabrio, coupe, sport susp & S/W)	Front	
742012SP >  742013SP > 	BMW	98-05	E46 - Sport Pack II for BMW OE Sport Susp  Ci	Front	
742012SP >  742013SP > 	BMW	00-06	 325Ci, 330 Ci Coupe Sport Pac II  M3) (E46)	Front	
742012SP >  742013SP > 	BMW	Nov'01-05	325ti Compact (E46)  Sport susp	Front	
742012SP >  742013SP > 	BMW	Oct '01-06	 325Ci, 330 Ci Coupe  Sport Pac II & M3) (E46)	Front	
742016SP  742017SP 	BMW	Nov'03-May'10	All E60 5 Series sedan  Touring S/W, M5 & Sport susp)	Front	
742024SP	MERCEDES-BENZ	06-March '12	B170, B200T, B200CDi (W245)	Front	
742025SP	JAGUAR	02-09	X-Type (X400)  R	Front	
742026SP >  742027SP > 	BMW	96-'03	520i, 523i, 525i, 528i, 530d & 530i (E39)  535i, 540i, Sport susp, M5, Air Susp, M Tech, Elec susp & S/W)	Front	
742026SP >  742027SP > 	BMW	97-'03	5 Series Touring S/W  540i and Sport susp)	Front	
742032SP  742033SP 	BMW	91-99	316i, 318i, 318is, 318tds, 320i, 323i, 325i, 325td, 325tds, 328i Imported & Local Strut.  Cabrio.  M. Tech). (E36) (short neck)	Front	
742032SP  742033SP 	BMW	93-99	 323i, 325i & 328i Cabriolet  M Tech) (E36)	Front	
742034SP  > 742035SP  >	BMW	91-92	320i, 325i & 325td Imported  M. Tech. (E36) (long neck)	Front	
742038SP  742039SP 	BMW	97-'03	Z3 1.8, 1.9, 2.8 & 3.0 (E36)  M-tech & M Coupe	Front	
742040SP  > 742041SP  >	BMW	End 04-Oct '11	1 Series 116i, 118i, 120i, 130i & 120d  Sport Susp, xDrive & 135i Coupe)	Front	
742040SP  > 742041SP  >	BMW	March '05-12	3 series (E90 & E91) 320i, 320d, 323i, 325i, 330d, 330i & 335i  Sport susp, M3, Cabrio & Coupe)	Front	
742040SP  > 742041SP  >	BMW	07-12	 330i, 335i Cabriolet  M3, Coupe) (E93)	Front	
742043SP >	AUDI	00-06	TT 1.8 Turbo Coupe & Roadster/Cabriolet (8N)  Sport Susp & 3.2 V6 Quattro (8N)	Front	
742044SP	AUDI	11-May '18	A1 Gen 1 (8X) Sport susp & 1.4 TFSI (185 PS)	Front	
742044SP	VOLKSWAGEN	March 18-on	 Polo VIVO GT & Sport susp (mk 5 model, 6R, 6C)  Maxx	Front	
742044SP	VOLKSWAGEN	Feb'10-Feb '18	  Polo VIVO GT & Sport susp (mk 4 9N3)  Maxx	Front	

Key











	See important installation information on inside front cover
	Excluding self-levelling suspension
	Special order - phone 010 900 1850. 6-12 week waiting period

	Imported
	Internal bump stop
	Steering damper

- It is recommended that all new shock absorbers are fitted in pairs
- Do not mix gas and non-gas units on the same axle
- **Bold** part numbers indicate heavy-duty shocks
- Underlined part numbers indicate parts not immediately available
- *Italic* part numbers followed by > indicate parts to be discontinued

Passenger and light commercial

Part number [numerical listing]

Part number	Make	Year	Application	Position	Mounting information
742044SP	VOLKSWAGEN	Feb'10-Jan '18	 Polo GTi & Sport susp Hatch, EXC Std susp, Vivo, Sedan & Cross (mk 5 model, 6R, 6C)	Front	
742047SP >	ALFA ROMEO	00-06	156 Sportwagon EXC GTA / elec susp / self leveling rears)	Rear	
742049SP R > 742050SP L >	MINI	07-13	Mini One, Cooper, Cooper D, Cooper S, One D (R56,R57 Mk II) MC cabriolet (R57) & sport	Front	
742049SP R > 742050SP L >	MINI	08-14	Mini Clubman S/Wagon MC sport (R55) mkl	Front	
742052SP >	SEAT	06-08	Ibiza Hatch & Sedan EXC sport susp)	Front	
742054SP >	VOLVO	00-10	S60 Sedan gen 1 (EXC elec susp, Four-C, R 2.5 20V, AWD, Lowered & Nivomat Levelling Suspensions)	Front	
742054SP >	VOLVO	98-July'06	S80 Sedan gen 1 (EXC elec susp Four-C, Lowered & Nivomat Leveling Suspensions).	Front	
742054SP >	VOLVO	00-07	V70 S/Wagon Gen 2 (EXC elec susp, Four-C, R 2.5 20V, XC AWD, Lowered & Nivomat Levelling Suspensions)	Front	
742054SP >	VOLVO	00-July'07	XC70 SUV AWD gen 2 EXC Four-C elec & self level suspension	Front	
742059SP R > 742060SP L >	BMW	94-02	728i, 730d, 735i, 740i & 750i & Limo (E38) EXC , Air Susp. & elec susp)	Front	
742061SP R > 742062SP L >	VOLVO	07-13	C30 Hatch	Front	
742061SP R > 742062SP L >	VOLVO	06-14	 C70 Cabriolet	Front	
742061SP R > 742062SP L >	VOLVO	June'04-Oct '12	S40 Sedan & V50 S/W MC T5 (Gen 2)	Front	
742065SP R > 742066SP L >	BMW	96-03	535i & 540i (E39) EXC "protection", M5, Air Susp, M Tech, Sport susp, Elec susp & S/W)	Front	
742069SP R > 742070SP L >	BMW	End 04-Oct '11	1 Series 116i, 118i, 120i, 130i, 135i & 120d Sport Susp MC std 135i Coupe EXC xDrive)	Front	
742069SP R > 742070SP L >	BMW	07-12	 330i, 335i Cabriolet EXC M3, Coupe) (E93)	Front	
742069SP R > 742070SP L >	BMW	March '05-12	3 series Sport susp, (E90 & E91) 320i, 320d, 323i, 325i, 330d, 330i & 335i EXC M3, Cabrio & Coupe)	Front	
742069SP R > 742070SP L >	BMW	07 - 12	 320i, 325i, 335i Coupe EXC M3, Cabrio) (E92)	Front	
742071SP	MERCEDES-BENZ	5/07-May'14	C180, C200, C220Cdi, C230, C250, C250Cdi, C280, C300, C320Cdi, C350Cdi & C350 EXC elec susp, Self level susp, AMG, Coupe, 4-Matic & Sports susp)	Front	
742071SP	MERCEDES-BENZ	12-May'14	C Class Coupe EXC Sport susp & AMG (Std Susp)	Front	
742073SP	VOLVO	02-July'15	XC90 AWD 2.4D, 3.2, 4.4 V8 Cross Country S/Wagon gen 1 (EXC Elec or self lev susp)	Front	
742074SP	AUDI	00-06	TT 1.8 Turbo Coupe & Roadster/Cabriolet (8N) EXC Sport Susp & 3.2 V6 Quattro (8N)	Front	
742080SP R > 742081SP L >	FORD	Nov'04-July'11	Focus 1.6, 1.6Si, 1.8TDCi, 2.0, 2.0Si, 2.0TDCi & TDCi Si, MC 2.5 ST front only, Hatch and Sedan MkII DA, DP EXC 2.5 ST rear & RS)	Front	
742089SP R > 742090SP L >	OPEL	End 02-Oct '07	Corsa Hatch & Classic (sedan) (EXC Lite) (C)	Front	
742106SP R > 742107SP L >	VOLVO	Aug '06-'14	S80 Sedan gen 2 (EXC elec susp, T6, Four-C, Lowered, sport & Nivomat Leveling Suspensions)	Front	
742106SP R > 742107SP L >	VOLVO	Aug '06-'14	S80 Sedan T6 AWD gen 2 All EXC elec susp, Lowered & Nivomat Leveling Suspensions)	Front	
742106SP R > 742107SP L >	VOLVO	07-10	V70 S/Wagon Gen 3 EXC D5, T6, Four-C AWD, V70 R, Elec susp, XC 4WD	Front	
742106SP R > 742107SP L >	VOLVO	Aug '07-15	XC70 SUV AWD 3.0 T6. 3.2, 2.4 D5 gen 3 EXC elec susp	Front	
742114SP R > 742115SP L >	OPEL	01-05	Zafira 1.6, 1.8, 1.9CDTi, 2.2 MPV EXC 2.0 turbo & OPC) (A)	Front	
742116SP	AUDI	Late '12-20	   A3 all Gen 3 (8V) MC Sportback, Quattro, Sport Susp EXC S3 & Elec susp). OE Strut leg outer diam = 50mm	Front	
742116SP	AUDI	12-on	A3 Cabriolet MC Quattro Gen 3 (8V)	Front	
742116SP	VOLKSWAGEN	15-17	Golf SV (Sportsvan) MPV EXC elec susp) 50mm strut OD	Front	
742116SP	VOLKSWAGEN	13-19	Golf VII EXC Gti, V5, R, AWD & Sport susp) (5G) EXC elec susp) OE Strut leg outer diam = 50mm	Front	
742117SP	AUDI	Late '12-20	   A3 all Gen 3 (8V) MC Sportback, Quattro, Sport Susp EXC S3 & Elec susp). OE Strut leg outer diam = 55mm	Front	
742117SP	AUDI	12-on	A3 Cabriolet MC Quattro Gen 3 (8V)	Front	
742117SP	AUDI	17 - 23	Q2 (35) 1.0, 1.4 (GAB & GAG)	Front	

Key

*	See important installation information on inside front cover
!	Excluding self-leveling suspension
"..."	Special order - phone 010 900 1850. 6-12 week waiting period

~	Imported
#	Internal bump stop
⊕	Steering damper

- It is recommended that all new shock absorbers are fitted in pairs
- Do not mix gas and non-gas units on the same axle
- **Bold** part numbers indicate heavy-duty shocks
- Underlined part numbers indicate parts not immediately available
- *Italic* part numbers followed by > indicate parts to be discontinued

Passenger and light commercial

Part number [numerical listing]

Part number	Make	Year	Application	Position	Mounting information
742117SP	AUDI	Oct 18 – on	Q3 1.4, 2.0 4x2 & 4x4 Quattro (EXCI RS 2.5 sport or elec susp) F3	Front	
742117SP	VOLKSWAGEN	20-on	T-Roc SUV (EXCI electronic susp (A11) (55mm strut leg)	Front	
742117SP	VOLKSWAGEN	Oct 16-23	Tiguan 4 Motion AWD & FWD 1.4TSI, 2.0 Tdi, 2.0TSI gen 2 (EXCI Allspace 7 seater (AD, BW) (EXCI electronic suspension (55mm strut leg)	Front	
742117SP	VOLKSWAGEN	13-19	Golf VII (EXCI Gti (EXCI V5, R, AWD & Sport susp) (56) (EXCI elec susp) OE Strut leg outer diam = 55mm	Front	
742129SP	MERCEDES-BENZ	Mid 09-April '16	W212 E200, E250, E250CDi, E300, E350, E400, E500 Std Susp (EXCI S/W, Coupe, Cabrio, AMG, sport susp, air susp, elec susp & AWD)	Front	
742129SP	MERCEDES-BENZ	Mid 09-April '16	W212 S/Wagon E200, E250, E300, E350, E500 Std Susp (EXCI Sedan, Coupe, Cabrio, AMG, sport susp, air susp, elec susp & AWD)	Front	
742132SP	BMW	Nov 11-19	1 series 116i, 118i, 120i, 125i & 120d (EXCI Sport Susp, Elec susp, x-Drive, 135i, M135i & M140i)	Front	
742132SP	BMW	April '14-on	2 Series 220i, 228i, 230i, 220d (EXCI elec susp, 235i, M235i, M240i, M2 & Sport Susp)	Front	
742132SP	BMW	13- Feb 18	3 Series F30 sedan (EXCI GT Gran Turismo 5 door liftback/hatch, S/W, Sport susp, Elec Susp, X-Drive and M series) Gen 6	Front	
742132SP	BMW	13-on	F34 Gran Turismo GT 3 series 5 door liftback/hatch (EXCI Sedan, S/Wagon, Sport susp and M series)	Front	
742132SP	BMW	13-on	4 Series Coupe, Gran Coupe (liftback) & Cabriolet SDrive (EXCI Sport susp, M4, Elec susp & Grand Coupe XDrive)	Front	
742132SP (EXCI 135i)	BMW	Nov 11-19	1 series Sport Susp (EXCI 135i, Elec susp, x-Drive, M135i & M140i)	Front	
742132SP (EXCI 235i, M235, M240)	BMW	April '14-on	2 Series Sport Susp (EXCI elec susp & M2)	Front	
742133SP	BMW	13- Feb 18	3 Series F30 sedan Sport Susp & F31 S/W std & Sport (EXCI GT Gran Turismo 5 door liftback/hatch, and M series) Gen 6	Front	
742133SP	BMW	13-on	4 Series Coupe, Gran Coupe (liftback) & Cabriolet Sport susp SDrive (EXCI elec susp, XDrive & M4)	Front	
742133SP	BMW	Nov 11-19	1 series 135i Sport Susp (EXCI elec susp, x-Drive, M135i & M140i)	Front	
742133SP	BMW	April '14-on	2 Series Sport Susp (EXCI elec susp & M2)	Front	
742160SP > 742161SP >	CITROEN	05-Oct '10	C4 (Gen 1) 1.6i, 2.0i, 2.0HDI (EXCI Coupe (EXCI DS4 & sport susp)	Front	
742180SP > 742181SP >	PEUGEOT	02-5/07	206 Cabrio cc	Front	
742186SP > 742187SP >	CITROEN	Nov 10-16	C4 (Gen 2) 1.6i, 2.0, 2.0 HDi (EXCI DS4 & sport susp)	Front	
742190SP > 742191SP >	CITROEN	11-16	DS4 1.6, 2.0	Front	
742190SP > 742191SP >	PEUGEOT	09-17	3008 MPV Crossover 1.6, 1.6 T, 2.0 Hdi gen 1 (EXCI self leveling susp) (T8 / OU)	Front	
742194SP > 742195SP >	OPEL	10-17	Meriva 1.4 mini MPV (B)	Front	
742196SP > 742197SP >	FORD	11-12	Kuga 4x2 & 4x4 SUV (gen 1) C394	Front	
742206SP > 742207SP >	PEUGEOT	13-19	2008 Crossover SUV 1.2T, 1.6 gen 1 (CU / A94) (47mm OD lower strut base)	Front	
742208SP > 742209SP >	PEUGEOT	13-19	2008 Crossover SUV 1.2T, 1.6 gen 1 (CU / A94) (51mm OD lower strut base)	Front	
742216SP >	ALFA ROMEO	97-05	156 ALL (EXCI GTA, Sport susp)	Rear	
742222SP > 742223SP >	FIAT	14-18	500L 1.4, 1.6 (5 door) (EXCI Std 500 models, "X" models, Abarth / sport susp (351 & 352)	Front	
742238SP > 742239SP >	TOYOTA	Nov 02-Sept '07	Corolla Sedan & RunX Hatch (EXCI Verso MPV, TRD) gen 9 (E120 & E121)	Front	
742240SP > 742241SP >	VOLVO	09-Sept 18	XC60 AWD Cross Country SUV gen 1 (EXCI elec & self leveling susp	Front	
742242SP >	VOLKSWAGEN	04-Feb '09	Golf V (EXCI Gti, V5, R32 & Sport susp) 1K1 OE Strut leg outer diam = 55mm Check sticker on OE shock: 1T0 412 103 A	Front	
742242SP >	VOLKSWAGEN	March '09-13	Golf VI (EXCI Gti, V5, R32, AWD, Elec & Sport susp) OE Strut leg bottom outer diam = 55mm	Front	
742243SP >	AUDI	May '03-12	A3 all (EXCI Sportback (EXCI Quattro, Sport Susp & S3) OE Strut leg bottom outer diam = 50mm	Front	
742247SP >	AUDI	May '03-12	A3 all (EXCI Sportback (EXCI Quattro, Sport Susp & S3) OE Strut leg bottom outer diam = 55mm	Front	
742247SP >	AUDI	11 – Sept '18	Q3 2.0TDi, 2.0T 4x2 & 4x4 Quattro (EXCI RS 2.5 sport or elec susp) 8U	Front	
742247SP >	VOLKSWAGEN	Oct '12-17	New Beetle (Type 2 / A5) 55mm front strut body	Front	
742247SP >	VOLKSWAGEN	07-15	Eos Cabriolet	Front	

Key

*	See important installation information on inside front cover
!	Excluding self-levelling suspension
"..."	Special order – phone 010 900 1850. 6-12 week waiting period

~	Imported
#	Internal bump stop
⊕	Steering damper

- It is recommended that all new shock absorbers are fitted in pairs
- Do not mix gas and non-gas units on the same axle
- **Bold** part numbers indicate heavy-duty shocks
- Underlined part numbers indicate parts not immediately available
- *Italic* part numbers followed by > indicate parts to be discontinued

Passenger and light commercial

Part number [numerical listing]

Part number	Make	Year	Application	Position	Mounting information
742247SP >	VOLKSWAGEN	04-Feb'09	Golf V Gti & R32 MC 4 Motion AWD	Front	
742247SP >	VOLKSWAGEN	March '09-13	Golf VI Gti & R32 MC 4 Motion AWD EX elec susp	Front	
742247SP >	VOLKSWAGEN	March '06-Sept'11	Jetta V (Sport susp) 1K2 (A5) OE Strut leg bottom outer diam = 55mm	Front	
742247SP >	VOLKSWAGEN	05 - 11	Passat Sedan, & S/Wagon Sportline Sport Susp MC AWD 4 Motion Syncro EX elec susp (B6)	Front	
742247SP >	VOLKSWAGEN	09-17	Scirocco EX elec, R or sport susp (137)	Front	
742247SP >	VOLKSWAGEN	08-Sept 16	Tiguan 4 Motion AWD & FWD MC Blue Motion EX elec susp) gen 1 (5N)	Front	
742247SP >	VOLKSWAGEN	04-16	Touran MPV EX Elec & heavy duty Susp (1T gen 1)	Front	
742253SP	AUDI	07-March '15	TT 1.8T, 2.0T, 3.2 V6 Coupe & Roadster/Cabriolet, MC Quattro & Sport susp (8J) EX elec susp & 2.5RS Quattro) (8J)	Front	
742267SP R 742268SP I	CITROEN	16-on	C3 III (SX, SY) (lower strut outer diameter is 47mm)	Front	
742269SP	VOLKSWAGEN	18-22	Arteon 4 door Sport coupe (3H7) Std suspension	Front	
742269SP	VOLKSWAGEN	Sept'15-19	Passat sedan EX elec susp) (B8)	Front	
742272SP R 742273SP I	OPEL	Nov'15-19	Corsa Hatch 1.0T, 1.4 MC 1.4 Turbo Sport (E)	Front	
742277SP R 742278SP I	MERCEDES-BENZ	14-19	GLA200, GLA200d, GLA220d, GLA250. EX elec susp & AMG gen 1 (X156)	Front	
742281SP R 742282SP I	HYUNDAI	April 16-22	Tucson All (TL) gen 3	Front	
742281SP R 742282SP I	KIA	April '16 - Sept 22	Sportage 4x2 1.6Gdi Gen 4 (QL)	Front	
742287SP	OPEL	18-on	Grandland & Grandland X 1.6T SUV (A18)	Front	
742287SP	PEUGEOT	17-on	3008 MPV 1.2T, 1.6T, 2.0 Hdi Crossover gen 2 EX self leveling susp) (P84 / MC, MR, MJ, M4)	Front	
742287SP	PEUGEOT	17-on	5008 1.6T MPV gen 2 (P87, MC, MJ, MR, M4)	Front	
742290SP R 742291SP I	FIAT	15-on	500X 1.4, 1.6 5 door Cross over SUV (FWD)	Front	
742290SP R 742291SP I	JEEP	15-on	Jeep Renegade (BU) SUV 4x2	Front	
742292SP R 742293SP I	FIAT	15-on	500X 1.4, 1.6 5 door Cross over SUV (FWD)	Rear	
742292SP R 742293SP I	JEEP	15-on	Jeep Renegade (BU) SUV 4x2	Rear	
742294SP R 742295SP I	FIAT	15-on	500X 1.4, 1.6 5 door Cross over SUV (AWD)	Rear	
742294SP R 742295SP I	JEEP	15-on	Jeep Renegade (BU) SUV 4x4	Rear	
742296SP R 742297SP I	FIAT	15-on	500X 1.4, 1.6 5 door Cross over SUV (AWD)	Front	
742296SP R 742297SP I	JEEP	15-on	Jeep Renegade (BU) SUV 4x4	Front	
742298SP R 742299SP I	FORD	15-early18	Focus (facelift) 1.0, 1.5, 1.6, 2.0Si, 2.0TDCi, TDCi Si, MC 2.0ST front only, Hatch and Sedan MkIII C346 facelift EX 2.0 ST rear & RS)	Front	
742298SP R 742299SP I	FORD	13-23	Tourneo Connect 5 & 7 seater minivan & Transit Connect compact minivan (gen 2 - V408, P65, P70, P80) FWD	Front	
744004SP R 744005SP I	TOYOTA	12-on	Avanza 1.3, 1.5 MPV & Panel Van MC ABS (F650) Gen 2 MC facelift smaller S/Pan	Front	
744066SP R 744067SP I	HONDA	11-14	Ballade gen 5 (GM2, GM3)	Front	
744066SP R 744067SP I	HONDA	08-Jan'15	Jazz 1.4 Dsi & 1.5 Vtec gen 2 (GE)	Front	
744072SP R 744073SP I	HONDA	12-19	Brio hatch gen 1 (DD1, DD2)	Front	
744072SP R 744073SP I	HONDA	12-19	Amaze sedan gen 1 (DF1, DF2)	Front	
744134SP R 744135SP I	NISSAN	02-March '08	X-Trail All gen1 (T30)	Front	
744136SP R 744137SP I	NISSAN	02-March '08	X-Trail All gen1 (T30)	Rear	
744390SP R 744391SP I	FORD	05-Sept'07	Territory 4x2 RWD SUV (SX, SY) (Btm U bracket)	Front	

Key











*	See important installation information on inside front cover
!	Excluding self-leveling suspension
"..."	Special order - phone 010 900 1850. 6-12 week waiting period

~	Imported
#	Internal bump stop
⊕	Steering damper

- It is recommended that all new shock absorbers are fitted in pairs
- Do not mix gas and non-gas units on the same axle
- **Bold** part numbers indicate heavy-duty shocks
- Underlined part numbers indicate parts not immediately available
- *Italic* part numbers followed by > indicate parts to be discontinued

Passenger and light commercial

Part number [numerical listing]

Part number	Make	Year	Application	Position	Mounting information
76028SP >	AUDI	Feb'99-Nov'00	 A4 Sedan 300 Sport susp, Avant S/W & Quattro) B5, 8D	Front	⊥ ⊗
83831EA	HONDA	11-14	Ballade gen 5 (GM2, GM3)	Rear	⊥ ⊖
83831EA	HONDA	08-Jan'15	Jazz 1.4 Dsi & 1.5 Vtec gen 2 (GE)	Rear	⊥ ⊖
83833EA	VOLKSWAGEN	10-21	Amarok pick-up 4x2 and 4x4 (gen 1)	Rear	⊖ ⊖
83840EA	RENAULT	09-Feb'14	Sandero Stepway (BS gen 1)	Rear	⊥ ○
83840EA	RENAULT	March '14-20	Sandero 0.9 Stepway (B8 gen 2)	Rear	⊥ ○
84751EA	VOLKSWAGEN	10-21	Amarok pick-up 4x2 and 4x4 (gen 1)	Front	
911044MM >	CHEVROLET	92-99	K-1500 1/2 ton pick-up 100 ext cab 4x4 (Ex Namibian Govt) 300 VW/Z71 off road package)	Rear	⊖ ⊖
911044MM >	CHEVROLET	92-99	K-2500 3/4 ton pick-up 4x4 (Ex Namibian Govt) 300 8600 GVW)	Rear	⊖ ⊖
911195MM	FORD	99-07	F250 (4x4) (check front mountings)	Front	○ ⊖
911196MM	FORD	99-07	F250 (4x4) (check front mountings)	Rear	○ ⊖
911266MM	FORD	05-09	F250 (4x4) (check front mountings)	Front	⊥ ○
911267MM	FORD	05-09	F250 (4x4) (check front mountings)	Rear	○ ⊖
911278MM	JEEP	07-09	Commander 3.0, 4.7 & 5.6 (XK)	Rear	⊖ ⊖
911278MM	JEEP	6/05 - 2/11	Jeep Grand Cherokee All (WK series) 300 up country / raised susp) 300 SRT8	Rear	⊖ ⊖
911304MM	JEEP	3/11-21	Jeep Grand Cherokee All (WK2 series) 100 2013 facelift. With (Btm U bracket), 300 SRT8, Air susp, elec or self-leveling susp.	Rear	⊥ ⊗
911522MM >	JEEP	99-5/05	Jeep Grand Cherokee All (WJ series) 100 Up country susp) Std Height	Front	⊥ ⊖
911523MM >	JEEP	99-5/05	Jeep Grand Cherokee All (WJ series) 100 Up country susp) Std Height	Rear	⊖ ⊖
911527MM >	HUMMER	05-11	H3 Std height	Front	⊥ T
911536MM	JEEP	07-18	Jeep Wrangler 4x4 (JK series) 2 & 4 door 100 Rubicon & Unlimited Std Height	Front	⊥ ⊖
911536MM	KIA	01 - 04	Pregio 12 seater minibus	Rear	⊥ ⊖
911538MM	JEEP	07-18	Jeep Wrangler 4x4 (JK series) 2 & 4 door 100 Rubicon & Unlimited Std Height	Rear	⊖ ⊖
94155A	FIAT	03-10	Palio II hatch Type 2H MkIV	Front	
94155A	FIAT	01-10	Palio Expresso panel Van	Front	
94155A	FIAT	02-10	Siena II sedan Smaller S/Pan	Front	
94176A	FIAT	05-16	Strada 3/4 ton LDV Pickup: 1.2, 1.4, 1.6, 1.7TD	Front	
94204EA	RENAULT	09-Feb'14	Sandero Stepway (BS gen 1)	Front	
AU150202 >	FORD	96- 98	 Falcon Gli, Futura, Fairmont EF, EH, EL 100 XR6	Rear	⊥ ⊖
AU150202 >	FORD	end 98-01	 Falcon Futura & Fairmont sedan AU 300 IRS) 100 XR6	Rear	⊥ ⊖
AU150202 >	FORD	end 01-Sept'02	 Falcon Futura & Fairmont sedan AU II (Std. Susp, 300 IRS & XR6)	Rear	⊥ ⊖
AU150509 >	FORD	Oct '02-08	 Falcon Sedan 300 XR6)	Rear	⊖ ⊖
AU150537	FORD	05-Sept'07	Territory 4x2 RWD SUV (SX, SY)	Rear	⊖ ⊖
AU150537	FORD	05-Sept'07	Territory 4x4 SUV (SX, SY)	Rear	⊖ ⊖
AU150537	FORD	Oct '07-09	Territory 4x2 RWD SUV (SY1)	Rear	⊖ ⊖
AU150537	FORD	Oct '07-09	Territory 4x4 SUV (SY1)	Rear	⊖ ⊖
AU160192 >	TOYOTA	72-86	Landcruiser 40 series LDV leaf springs	Front	○ ○
AU160201 >	MITSUBISHI	88-91	Pajero 4x4 gen 1 (L146G) Coil rear	Front	⊥ ⊖
AU160207 >	NISSAN	89- 97	Patrol S/W 4x4 GQ / GR Y60 Series (Coil springs) 10mm OD studs	Front	⊥ T
AU160208 >	NISSAN	89- 97	Patrol S/W 4x4 GQ / GR Y60 Series (Coil springs) 19mm ID mounting holes	Rear	○ ○
AU160460	LAND ROVER	99- end 04	Discovery 2 100 Active ride control (L318)	Front	⊖ ⊖
AU160461	LAND ROVER	99- end 04	Discovery 2 100 Active ride control (L318)	Rear	⊖ ⊖
AU160466	TOYOTA	07-on	Landcruiser 76 & 78 series S/Wagon (Coil front, leaf rear) Std Susp	Front	⊥ T

Key









*	See important installation information on inside front cover
!	Excluding self-leveling suspension
"..."	Special order - phone 010 900 1850. 6-12 week waiting period

~	Imported
#	Internal bump stop
⊖	Steering damper

- It is recommended that all new shock absorbers are fitted in pairs
- Do not mix gas and non-gas units on the same axle
- **Bold** part numbers indicate heavy-duty shocks
- Underlined part numbers indicate parts not immediately available
- *Italic* part numbers followed by > indicate parts to be discontinued

Passenger and light commercial

Part number [numerical listing]

Part number	Make	Year	Application	Position	Mounting information
AU160466	TOYOTA	99-on	Landcruiser HZJ79 series LDV Rear leaf springs, Coil front stud OD 13mm Std Susp	Front	⊥ T
AU160499	NISSAN	07 - on	Patrol 4.2D Pick-Up 4x4 LDV Leaf spring rear (Y61)	Rear	⊖ T
AU160604	NISSAN	05-March 17	Navara 4x2 & 4x4 2.5 dCi, 3.0, 4.0 V6 LDV (D40) Std height	Rear	○ ⊖
AU160766	TOYOTA	08-July 20	Landcruiser 200 Series S/Wagon (Elec elec susp) St Height	Rear	⊥ ⊖
AU160833	NISSAN	05-March 17	Navara 4x2 & 4x4 2.5 dCi, 3.0, 4.0 V6 LDV (D40) Raised +-30mm	Rear	○ ⊖
AU160844	MITSUBISHI	07-16	Triton LDV All 4x4 & 4x2 raised body Std height gen 4 (MN) Raised +-30mm	Rear	○ ○
AU160865	TOYOTA	June 05-Jan 16	HiLux / Vigo "D4D" 4x4 & Raised body 4x2, gen 7 Raised +-40mm	Rear	○ ○
AU160882	ISUZU	April '13-'21	KB / D-Max 4X4 P190 / RT50 / RT85 & 4x2 Hi-Rider raised body RT series Raised 50mm	Rear	○ ○
AU160890	MITSUBISHI	09- Aug '17	Pajero Sport SUV gen 2 (KG/KH/PB)	Rear	○ ○
AU160894	TOYOTA	90-98	Landcruiser 80 series S/Wagon (MC certain solid axle 105 series '98-'07 models) All Standard Susp	Front	⊥ T
AU160895	TOYOTA	90-98	Landcruiser 80 series S/Wagon (MC certain solid axle 105 series '98-'07 models) All Standard Susp	Rear	⊥ ⊖
AU160895	TOYOTA	95-02	4-Runner & Surf Gen 3 (N180)	Rear	⊥ ⊖
AU160922	FIAT	16-on	Fiat Fullback LCV ALL 4x2 raised body & 4x4	Rear	○ ○
AU160922	MITSUBISHI	17-24	Triton LDV All 4x4 & 4x2 raised body Std height gen 5 (MQ) (MC 2019 facelift (KJ/KK/KL)	Rear	○ ○
AU160939	CHEVROLET	12-18	Trailblazer SUV 7 seater (RG)	Rear	○ ○
AU161702 >	TOYOTA	84-End'98	HiLux All 4x4 (N505, N60) Raised +-20 to 40mm	Front	⊥ ⊖
AU161704	TOYOTA	83-89	Landcruiser 60 series S/Wagon Models #J6#V-... (FJ60, FJ62, HJ60, HJ6) Std Susp (10mm OD rod & 19mmID rubber bushing)	Front	⊥ ○
AU161704	TOYOTA	83-89	Landcruiser 60 series S/Wagon Models #J6#V-... (FJ60, FJ62, HJ60, HJ6) Raised +-30mm	Front	⊥ ○
AU161704	TOYOTA	87- 99	Landcruiser HZJ75 series LDV leaf springs Raised +-30	Front	⊥ ○
AU161704	TOYOTA	April '89 - 95	4-Runner & Surf gen 2 LN130, VZN130 (Elec elec susp, RZN180, RZN185, VZN185 (N120, N130)	Rear	⊥ ⊖
AU161712 >	DATSUN	65-80	1200, 1300, 1500, 1600, 620, 680 LDV (520, 521, 620 series)	Rear	○ T
AU161712 >	NISSAN	80-89	Patrol S/W 4x4 MQ / MK / 160 / 260	Rear	○ T
AU161712 >	NISSAN	80-82	Tracker (4x4)	Rear	○ T
AU161712 - D4437S	NISSAN	82-89	Safari (4x4) MQ	Rear	○ T
AU350288 > R AU350289 > L	FORD	96- 98	 Falcon Gli, Futura, Fairmont EF, EH, EL (MC XR6)	Front	
AU350288 > R AU350289 > L	FORD	96- 98	(S/W) Falcon Futura Fairmont S/Wagon EF, EH, EL (Std. susp.)	Front	
AU350288 > R AU350289 > L	FORD	96-Mid 99	Ranchero (Elec XR6)	Front	
AU350406	FORD	Mid 99-April '00	Ranchero All AUI (MC XR6)	Front	
AU350406 >	FORD	end 98-01	 Falcon Futura & Fairmont sedan AU (Elec IRS) (MC XR6)	Front	
AU350406 >	FORD	end 98-01	 Falcon XR6 AU (Lowered Susp, IRS) Check rear shock type	Front	
AU350406 >	FORD	end 98-01	(S/W) Falcon Futura & Fairmont S/Wagon AU (Std. Susp (MC IRS)	Front	
AU350447 >	FORD	end 01-Sept'02	 Falcon Futura & Fairmont sedan AU II (Std. Susp, (MC IRS & XR6)	Front	
AU350447 >	FORD	end 01-Sept'02	(S/W) Falcon Futura & Fairmont S/Wagon AU II (MC IRS)	Front	
AU350507 >	FORD	Oct '02-08	 Falcon Sedan (MC XR6)	Front	
AU350507 >	FORD	Oct '02-08	 Falcon Sedan XR6 (MC OE lowered)	Front	
AU350507 >	FORD	Oct '02-08	 Falcon S/Wagon	Front	
AU350659 >	FORD	05-Sept'07	Territory 4x4 SUV (SX, SY)	Front	
AU350660 R > AU350661 L >	FORD	05-Sept'07	Territory 4x2 RWD SUV (SX, SY) (Btm U bracket)	Front	
AU360590	MITSUBISHI	99-April '07	Pajero 4x4 gen3 K94W, K96W, V64W, V65W, V68W, V74W, V75W & V78W (NM, NP) (Elec elec susp) Check OE #'s	Front	⊥ ⊖
AU360590	MITSUBISHI	May'07-21	Pajero 4x4 gen 4 V80 (NT / NW)	Front	⊥ ⊖
AU360832	NISSAN	05-March 17	Navara 4x2 & 4x4 LDV (D40) Raised +-30mm	Front	⊥ ⊖

Key

*	See important installation information on inside front cover
!	Excluding self-levelling suspension
"..."	Special order - phone 010 900 1850. 6-12 week waiting period

~	Imported
#	Internal bump stop
⊖	Steering damper

- It is recommended that all new shock absorbers are fitted in pairs
- Do not mix gas and non-gas units on the same axle
- **Bold** part numbers indicate heavy-duty shocks
- Underlined part numbers indicate parts not immediately available
- *Italic* part numbers followed by > indicate parts to be discontinued

Passenger and light commercial

Part number [numerical listing]

Part number	Make	Year	Application	Position	Mounting information
AU360837 >	TOYOTA	03-Oct '09	Prado J120 (5 door) / J125 (3 door) Series (301) elec susp) Raised +-40mm	Front	⊥ ⊕
AU360845 >	MITSUBISHI	07-16	Triton LDV Raised +-30mm All 4x4 & 4x2 raised body Std height gen 4 (MN)	Front	⊥ ⊕
AU360845 >	MITSUBISHI	17-24	Triton LDV Raised +-30mm All 4x4 & 4x2 raised body Std height gen 5 (MO) (104) 2019 facelift (KJ/KK/KL)	Front	⊥ ⊕
AU360864	TOYOTA	June '05-Jan 16	Hilux / Vigo "D4D" 4x4 & Raised body 4x2, gen 7 Raised 25mm r – Designed to be used on vehicles with steel bull bar, extra battery, winch, underbody protection etc. (90kg+ extra front axle load)	Front	⊥ ⊕
AU360881	ISUZU	April '13-'21	KB / D-Max 4X4 P190 / RT50 / RT85 & 4x2 Hi-Rider raised body RT series Raised 30mm to 60mm	Front	⊥ ⊕
AU360886	MITSUBISHI	09- Aug '17	Pajero Sport SUV gen 2 (KG/KH/PB)	Front	⊥ ⊕
AU360886	MITSUBISHI	07-16	Triton LDV All 4x4 & 4x2 raised body Std height gen 4 (MN)	Front	⊥ ⊕
AU370406 >	FORD	end 98-01	 Falcon Futura & Fairmont sedan AU (301) IRS (104) XR6	Front	⊥ ⊕
AU370406 >	FORD	end 98-01	(S/W) Falcon Futura & Fairmont S/Wagon AU (Std. Susp (301) IRS)	Front	⊥ ⊕
AU374406 >	FORD	end 98-01	 Falcon XR6 AU (Lowered Susp, IRS) Check rear shock type	Front	⊥ ⊕
C1510R / C1511L	MERCEDES-BENZ	5/07-May'14	W204 Sedan Elec Suspension (104) Coupe)	Rear	⊥ ⊕
C1512S	VOLVO	10-18	S60 Sedan, gen 2 Electronic susp	Rear	⊥ ⊕
C1512S	VOLVO	Aug '06-'14	S80 Sedan gen 2 Electronic Susp, Four-C	Rear	⊥ ⊕
C1512S	VOLVO	11-18	V60 S/Wagon (104) Cross Country Electronic susp	Rear	⊥ ⊕
C1514R / C1517L	VOLKSWAGEN	09-17	"Passat" CC Elec Susp (104) AWD 4 Motion Syncro	Rear	⊥ ⊕
C1514R / C1517L	VOLKSWAGEN	March '09-13	Golf VI All Electronic suspension	Rear	⊥ ⊕
C1514R / C1517L	VOLKSWAGEN	05 – 11	 (S/W) Passat Sedan, & S/Wagon All Electronic Suspension (B6)	Rear	⊥ ⊕
C1514R / C1517L	VOLKSWAGEN	04-16	Touran MPV Electronic Susp (1T gen 1)	Rear	⊥ ⊕
C1520S	VOLKSWAGEN	13-19	Golf VII All Electronic suspension 45mm btm sleeve (5G)	Rear	⊥ ⊕
C1521S	VOLKSWAGEN	18-22	Arteon 4 door Sport coupe (3H7) Electronic susp	Rear	⊥ ⊕
C1521S	VOLKSWAGEN	13-19	Golf VII All Electronic suspension 59mm btm sleeve (5G)	Rear	⊥ ⊕
C1521S	VOLKSWAGEN	13-17	Golf SV All Electronic suspension – 59mm btm sleeve	Rear	⊥ ⊕
C1521S	VOLKSWAGEN	Sept'15-19	Passat sedan All Electronic Suspension (B8)	Rear	⊥ ⊕
C1521S	VOLKSWAGEN	Oct 16-23	Tiguan 4 Motion AWD & FWD 1.4TSI, 2.0 Tdi, 2.0TSi Electronic Suspension gen 2 (104) Allspace 7 seater (AD, BW)	Rear	⊥ ⊕
C1527R / C1528L	MERCEDES-BENZ	Mid 09-16	C207 Coupe Elec Susp (301) Sedan, S/W, AMG, air susp)	Rear	⊥ ⊕
C1529R / C1530L	MERCEDES-BENZ	Mid 09-16	207 Cabriolet Elec Susp (301) Sedan, S/W, AMG, air susp)	Rear	⊥ ⊕
C1532S	BMW	11-18	X3 (F25) Elec susp + X4 (F26) Elec susp	Rear	⊥ ⊕
C2508R / C2509L	MERCEDES-BENZ	5/07-May'14	W204 Elec Suspension (104) Coupe)	Front	⊥ ⊕
C2508R / C2509L	MERCEDES-BENZ	12-May'14	C Class Coupe (301) Sport susp & AMG (Elec Susp)	Front	⊥ ⊕
C2508R / C2509L	MERCEDES-BENZ	Mid 09-April '16	W212 S/Wagon E200, E250, E300, E350, E500 Elec Susp (301) Sedan, Coupe, Cabrio, AMG, sport susp, air susp, elec susp & AWD)	Front	⊥ ⊕
C2508R / C2509L	MERCEDES-BENZ	Mid 09-April '16	W212 E200, E250, E250CDi, E300, E350, E400, E500 Elec Susp (301) S/W, Coupe, Cabrio, AMG, sport susp, air susp, elec susp & AWD)	Front	⊥ ⊕
C2508R / C2509L	MERCEDES-BENZ	Mid 09-16	C207 Coupe Elec Susp (301) Sedan, S/W, AMG, air susp)	Front	⊥ ⊕
C2508R / C2509L	MERCEDES-BENZ	Mid 09-16	207 Cabriolet Elec Susp (301) Sedan, S/W, AMG, air susp)	Front	⊥ ⊕
C2510R & C2511L	VOLVO	Aug '06-'14	S80 Sedan gen 2 Electronic Susp, Four-C	Front	⊥ ⊕
C2510R / C2511L	VOLVO	10-18	S60 Sedan, gen 2 Electronic susp	Front	⊥ ⊕
C2510R / C2511L	VOLVO	11-18	V60 S/Wagon (104) Cross Country Electronic susp	Front	⊥ ⊕
C2510R / C2511L	VOLVO	07-10	V70 S/Wagon Gen 3 All (104) Four-C AWD & Elec susp (301) XC 4WD)	Front	⊥ ⊕
C2513S	VOLKSWAGEN	09-17	"Passat" CC Elec Susp (104) AWD 4 Motion Syncro	Front	⊥ ⊕
C2513S	VOLKSWAGEN	March '09-13	Golf VI All Electronic suspension	Front	⊥ ⊕
C2513S	VOLKSWAGEN	05 – 11	 (S/W) Passat Sedan, & S/Wagon All Electronic Suspension (B6)	Front	⊥ ⊕
C2513S	VOLKSWAGEN	08-Sept 16	Tiguan Elec Susp gen 1 (5N)	Front	⊥ ⊕

Key

*	See important installation information on inside front cover
!	Excluding self-levelling suspension
"..."	Special order – phone 010 900 1850. 6-12 week waiting period

~	Imported
#	Internal bump stop
⊕	Steering damper

- It is recommended that all new shock absorbers are fitted in pairs
- Do not mix gas and non-gas units on the same axle
- **Bold** part numbers indicate heavy-duty shocks
- Underlined part numbers indicate parts not immediately available
- *Italic* part numbers followed by > indicate parts to be discontinued

Passenger and light commercial

Part number [numerical listing]

Part number	Make	Year	Application	Position	Mounting information
C2513S	VOLKSWAGEN	04-16	Touran MPV Electronic Susp (1T gen 1)	Front	
C2516S	VOLKSWAGEN	18-22	Arteon 4 door Sport coupe (3H7) Electronic susp	Front	
C2516S	VOLKSWAGEN	13-19	Golf VII All Electronic suspension (5G)	Front	
C2516S	VOLKSWAGEN	13-17	Golf SV All Electronic suspension	Front	
C2516S	VOLKSWAGEN	Sept'15-19	Passat sedan All Electronic Suspension (B8)	Front	
C2516S	VOLKSWAGEN	Oct 16-23	Tiguan 4 Motion AWD & FWD 1.4TSi, 2.0 Tdi, 2.0TSi Electronic Suspension gen 2 Allspace 7 seater (AD, BW)	Front	
C2525R	BMW	11-18	X3 (F25) Elec susp + X4 (F26) Elec susp	Front	
C2526L	BMW	11-18	X3 (F25) Elec susp + X4 (F26) Elec susp	Front	
D0001R / D0002L	DAIHATSU	98-May'00	Terios 4x2 & 4x4 (J100) Generation One	Front	
D0001R / D0002L	DAIHATSU	May'00 – May'06	Terios 4x2 & 4x4 (J100) Generation One	Front	
<i>D0003 > D0003R / D0004L</i>	LAND ROVER	98-01	Freelander 1.8 & 2.0D 2.5 V6 (L314)	Front	
D0005R / D0006L	LAND ROVER	98-01	Freelander 1.8 & 2.0D 2.5 V6 (L314)	Rear	
D0005R / D0006L	LAND ROVER	01-March '07	Freelander All 2.5 V6 (L314)	Rear	
<i>D0009 > D0009R / D0010L</i>	TOYOTA	98-00	RAV4 Type SXA 10 & 11 Sealed front struts (235/60R 16" wheels) gen 1	Front	
D0011R / D0012L	CHERY	08-Jan'14	Tiggo	Front	
D0011R / D0012L	TOYOTA	01- Feb'06	RAV4 (ACA20,21 / ZCA 25, 26 / XA20) gen 2	Front	
D0023R / D0024L	NISSAN	07-09	Qashqai SUV All (J10)	Front	
D0023R / D0024L	NISSAN	10-June'14	Qashqai SUV 2.0 dci (J10 facelift, +2)	Front	
<i>D0025 > D0025R / D0026L</i>	NISSAN	10-June'14	Qashqai SUV all +2, 1.5dci, 1.6, 2.0 (J10 facelift)	Front	
D0027R / D0028L	NISSAN	April '08-Aug '14	X-Trail All gen 2 (T31)	Front	
D0027R / D0028L	RENAULT	08-13	Koleos 4x4 SUV gen 1 (HY)	Front	
D0029R / D0030L	SUZUKI	05-20	Grand Vitara 4x4 2.4i, 3.2i gen 3 (JT)	Front	
D0036 >	BMW	10-Oct 15	X1 (E84) xDrive AWD	Front	
<i>D0036R / D0037L</i>	BMW	10-Oct 15	X1 (E84) xDrive AWD	Front	
D0038 >	BMW	10-Oct 15	X1 (E84) sDrive FWD	Front	
D0038R / D0039L	BMW	10-Oct 15	X1 (E84) sDrive FWD	Front	
D0040R / D0041L	OPEL	15-April 22	Mokka & Mokka X cross-over SUV FWD (AWD) (Facelift Aug '16) gen 1 (J13)	Front	
D0047R / D0048L	NISSAN	Sept '14-23	X-Trail All gen 3 (T32)	Front	
D0049R / D0050L	NISSAN	July'14-Sept 22	Qashqai SUV 1.2T, 1.5dci, 1.6dci 4x2 and 1.6dci 4x4 (J11)	Front	
D0049R / D0050L	RENAULT	16-18	Kadjar 1.2, 1.5dCi 4x2 & AWD SUV (HA, HL)	Front	
D0202R / D0203L	SUZUKI	98-04	Grand Vitara 4x4 XL gen 2 (FT, GT)	Front	
D0301R	AUDI	06 – June'15	Q7 4x4 Quattro (sport or air susp) Gen one 4L facelift	Front	⊕
D0302L	AUDI	06 – June'15	Q7 4x4 Quattro (sport or air susp) Gen one 4L facelift	Front	⊕
<i>D0303 > D0303R / D0304L</i>	PORSCHE	03-10	Cayenne 4x4 SUV (9PA) (Btm U brkt)	Front	⊕
<i>D0303 > D0303R / D0304L</i>	VOLKSWAGEN	04-10	Touareg 4x4 Elec, air or sport susp (7L)	Front	⊕
D0305 >	BMW	09-Jan'15	X6 (E71) Cross-over SUV (Mtech M5.0d, X6M, Elec or Self Leveling susp)	Front	
D0305 >	BMW	09-Jan'15	X6 (E71) Cross-over SUV Self Leveling (Mtech M5.0d, X6M or Elec susp)	Front	
<i>D0305S</i>	BMW	09-Jan'15	X6 (E71) Cross-over SUV (Mtech M5.0d, X6M, Elec or Self Leveling susp)	Front	
D0305S	BMW	07-13	X5 (E70) 3.5i xDrive, 5.0i V8 xDrive, 3.0d xDrive, 4.0d xDrive 4x4, sport susp (Mtech M5.0d, Elec or Self Leveling susp)	Front	
D0305S	BMW	07-13	X5 (E70) 3.5i xDrive, 5.0i V8 xDrive, 3.0d xDrive, 4.0d xDrive 4x4, Self Leveling & sport susp (Mtech M5.0d or Elec susp)	Front	

Key

*	See important installation information on inside front cover
!	Excluding self-leveling suspension
...	Special order – phone 010 900 1850. 6-12 week waiting period

~	Imported
#	Internal bump stop
⊕	Steering damper

- It is recommended that all new shock absorbers are fitted in pairs
- Do not mix gas and non-gas units on the same axle
- **Bold** part numbers indicate heavy-duty shocks
- Underlined part numbers indicate parts not immediately available
- *Italic* part numbers followed by > indicate parts to be discontinued

Passenger and light commercial

Part number [numerical listing]

Part number	Make	Year	Application	Position	Mounting information
<u>D0305S</u>	BMW	09-Jan'15	X6 (E71) Cross-over SUV MC Self Leveling EX Mtech M5.0d, X6M or Elec susp)	Front	
D0306R / D0307L	BMW	07-13	X5 (E70) 3.5i xDrive, 5.0i V8 xDrive, 3.0d xDrive, 4.0d xDrive 4x4, MC sport susp EX Mtech M5.0d, Elec or Self Leveling susp)	Rear	
D0306R / D0307L	BMW	09-Jan'15	X6 (E71) Cross-over SUV EX Mtech M5.0d, X6M, Elec or Self Leveling susp)	Rear	
D0308S	DAIHATSU	June'06 - 17	Terios 4x2 & 4x4 (J200 SWB 5 seater & J700 LWB 7 seater) Generation 2 EX models with Stabiliser bars or a "flat" area below the threads: OE# 48520BZ150A, 48510B4011, 48510B4061)	Front	
<u>D0309</u> > <u>D0309R</u> / <u>D0310L</u>	BMW	07-13	X5 (E70) 3.5i xDrive, 5.0i V8 xDrive, 3.0d xDrive, 4.0d xDrive 4x4, MC Self Leveling & sport susp EX Mtech M5.0d or Elec susp)	Rear	
<u>D0309</u> > <u>D0309R</u> / <u>D0310L</u>	BMW	09-Jan'15	X6 (E71) Cross-over SUV MC Self Leveling EX Mtech M5.0d, X6M or Elec susp)	Rear	
D0311S	BMW	11-17	X3 (F25) 2.0i, 2.8i, 3.0i, 3.5i & 2.0d, 30d MC Sport susp sDrive & xDrive AWD EX elec susp)	Rear	
D0311S	BMW	14-Sept 18	X4 (F26) 2.0i, 2.8i, 3.5i, 2.0d & 3.0d. MC Sport susp xDrive AWD EX elec susp & M40)	Rear	
<u>D0312</u> > <u>D0312R</u> / <u>D0313L</u>	VOLKSWAGEN	11-18	Touareg 4x4 EX Elec or sport susp (7P)	Front	
<u>D0314</u> > <u>D0314S</u>	VOLKSWAGEN	11-18	Touareg 4x4 EX Elec or sport susp (7P)	Rear	
D0401R / D0402L	LAND ROVER	01-March '07	Freelander All MC 2.5 V6 (L314)	Front	
D0405 >	BMW	04-10	X3 (E83) 2.5, 3.0 & 2.0 d MC Sport susp EX elec susp)	Front	
<u>D0405R</u> / <u>D0406L</u>	BMW	04-10	X3 (E83) 2.5, 3.0 & 2.0 d MC Sport susp EX elec susp)	Front	
D0407 >	BMW	01-06	X5 (E53) 3.0i, 3.0d, 4.4iV8, 4.8 V8 4x4, MC rear air susp EX elec or self leveling susp & EX front air susp)	Front	
<u>D0407R</u> / <u>D0408L</u>	BMW	01-06	X5 (E53) 3.0i, 3.0d, 4.4iV8, 4.8 V8 4x4, MC rear air susp EX elec or self leveling susp & EX front air susp)	Front	
D0409 >	CHEVROLET	07-18	Captiva SUV 4x2 & 4x4 Gen 1 MC facelift (C100) EX Elec or air susp, or self leveling rear ie on Diesel	Front	
<u>D0409R</u> / <u>D0410L</u>	CHEVROLET	07-18	Captiva SUV 4x2 & 4x4 Gen 1 MC facelift (C100) EX Elec or air susp, or self leveling rear ie on Diesel	Front	
D0414R / D0415L	BMW	11-17	X3 (F25) 2.0i, 2.8i, 3.0i, 3.5i & 2.0d, 30d MC Sport susp sDrive & xDrive AWD EX elec susp)	Front	
D0414R / D0415L	BMW	14-Sept 18	X4 (F26) 2.0i, 2.8i, 3.5i, 2.0d & 3.0d. MC Sport susp xDrive AWD EX elec susp & M40)	Front	
D0416R / D0417L	LAND ROVER	April '07-15	Freelander II (L359)	Front	
<u>D0418</u> > <u>D0418R</u> / <u>D0419L</u>	LAND ROVER	11-May 19	Range Rover Evoque gen 1 EX Elec susp & Sport (L538)	Front	
<u>D0418R</u> / <u>D0419L</u>	LAND ROVER	2015-Feb 2020	Discovery Sport SUV MC facelift (L550) EX elec susp	Front	
D0420R / D0421L	LAND ROVER	11-May 19	Range Rover Evoque gen 1 EX Elec susp & Sport (L538)	Rear	
D0422R / D0423L	LAND ROVER	April '07-15	Freelander II (L359)	Rear	
D0501S	RENAULT	13-19	Captur 0.9T, 1.2T, 1.5dci crossover SUV gen 1 (J87, J5, H5)	Front	
D0801S	TOYOTA	95-98	RAV4 Type SXA 10 & 11 EX sealed struts & 235/60R 16" wheels) gen 1	Front	
<u>D4001</u> >	JEEP	93- 98	Jeep Grand Cherokee All (ZJ series) MC Up- country Susp) Std Height	Front	
<u>D4002</u> >	JEEP	93- 98	Jeep Grand Cherokee All (ZJ series) MC Up- country Susp) Std Height	Rear	
<u>D4003</u> > <u>D4003S</u>	BMW	01-06	X5 (E53) 3.0i, 3.0d, 4.4iV8, 4.8 V8 4x4, MC rear air susp EX elec or self leveling susp & EX front air susp)	Rear	
D4004S	LAND ROVER	May'02-12	Range Rover gen 3 EX Sport) L322	Rear	
D4005S	BMW	04-10	X3 (E83) 2.5, 3.0 & 2.0 d MC Sport susp EX elec susp)	Rear	
<u>D4437S</u>	NISSAN	73-95	E20 van & Minibus	Rear	
<u>D4437S</u>	NISSAN	80-89	Patrol S/W 4x4 MQ / MK / 160 / 260	Rear	
D4437S	NISSAN	80-82	Tracker (4x4)	Rear	
<u>D4437S</u>	DATSUN	65-80	1200, 1300, 1500, 1600, 620, 680 LDV (520, 521, 620 series)	Rear	
<u>D4470</u> > <u>D4470S</u>	FORD	65-67	F100 & F250 (4x2)	Front	
<u>D4470</u> > <u>D4470S</u>	NISSAN	72-80	Patrol S/W 4x4	Front	
<u>D4470</u> > <u>D4470S</u>	NISSAN	80-89	Patrol S/W 4x4 MQ / MK / 160 / 260	Front	
<u>D4470</u> > <u>D4470S</u>	NISSAN	82-89	Safari (4x4) MQ	Front	

Key

*	See important installation information on inside front cover
!	Excluding self-leveling suspension
"..."	Special order - phone 010 900 1850. 6-12 week waiting period

~	Imported
#	Internal bump stop
⊕	Steering damper

- It is recommended that all new shock absorbers are fitted in pairs
- Do not mix gas and non-gas units on the same axle
- **Bold** part numbers indicate heavy-duty shocks
- Underlined part numbers indicate parts not immediately available
- *Italic* part numbers followed by > indicate parts to be discontinued

Passenger and light commercial

Part number [numerical listing]

Part number	Make	Year	Application	Position	Mounting information
<i>D4470 > D4470S</i>	NISSAN	72-80	Patrol S/W 4x4	Rear	⊥ T
<i>D4484 > D4484S</i>	NISSAN	98-17	Patrol S/W 4x4 GR 1 / GU I Y61 Series (Coil springs) MC '02-on 3.0TDi & 4.8i GR II / GU II series Std height Mounting sizes Top 19.5id hole / Btm 19.2 id hole	Rear	○ ⊖
D65353	VOLKSWAGEN	10-21	Amarok pick-up 4x2 and 4x4 (gen 1) ("Dakar" heavy duty / firm)	Front	
D65354	VOLKSWAGEN	10-21	Amarok pick-up 4x2 and 4x4 (gen 1) - "Dakar" heavy duty / firm	Rear	⊖ ⊖
D7004S	KIA	Sept'99-Oct '04	Sportage 4x4 & 4x2 Gen 1 (NB7 / FM)	Rear	⊥ ⊖
<i>D7005 > D7005S</i>	HONDA	98 - 02	CR-V 4x4 2.0 Gen 1 (RD1 - RD3)	Front	⊥ ⊗
<i>D7006 > D7006S</i>	HONDA	98 - 02	CR-V 4x4 2.0 Gen 1 (RD1 - RD3)	Rear	⊥ ⊖
<i>D7007 > D7007R / D7008L</i>	KIA	Sept'99-Oct '04	Sportage 4x4 & 4x2 Gen 1 (NB7 / FM)	Front	
<i>D7009 > D7009S</i>	SSANGYONG	06-12	Kyron 4x4 SUV with independent rear susp EX 4x2 = special order)	Front	⊥ ⊗
<i>D7009 > D7009S</i>	SSANGYONG	02-06	Rexton I & II 270, 290TD, E320 4x4 SUV (Y200)	Front	⊥ ⊗
<i>D7009 > D7009S</i>	SSANGYONG	07-12	Rexton I & II 270, 290TD, E320 4x4 SUV (Y250)	Front	⊥ ⊗
<i>D7011 > D7011S</i>	DAIHATSU	May'00 - May'06	Terios 4x2 & 4x4 (J100) Generation One	Rear	○ ○
D7018S	NISSAN	07-09	Qashqai SUV All (J10)	Rear	⊖ ⊖
D7018S	NISSAN	10-June'14	Qashqai SUV MC all +2, 1.5dci, 1.6, 2.0 (J10 facelift)	Rear	⊖ ⊖
D7018S	NISSAN	10-June'14	Qashqai SUV 2.0 dci (J10 facelift, EX +2)	Rear	⊖ ⊖
D7019S	NISSAN	April '08-Aug '14	X-Trail All gen 2 (T31)	Rear	⊖ ⊖
D7019S	NISSAN	Sept '14-23	X-Trail All gen 3 (T32)	Rear	⊖ ⊖
D7019S	RENAULT	08-13	Koleos 4x4 SUV gen 1 (HY)	Rear	⊖ ⊖
D7019S	NISSAN	July'14-Sept 22	Qashqai SUV 1.2T, 1.5dci, 1.6dci 4x2 and 1.6dci 4x4 (J11) Shock lengths open 324mm / closed 507mm	Rear	⊖ ⊖
D7020S	SUZUKI	05-20	Grand Vitara 4x4 2.4i, 3.2i gen 3 (JT)	Rear	⊖ ⊖
<i>D7021S</i>	TOYOTA	06-11	Avanza 1.3, 1.5 MPV & Panel Van MC & EX ABS (F600) Gen 1 MC facelift	Rear	⊖ ⊖
<i>D7021S ></i>	DAIHATSU	June'06 - 17	Terios 4x2 & 4x4 (J200 SWB 5 seater & J700 LWB 7 seater) Generation Two	Rear	○ ○
D7023S	RENAULT	13-19	Captur 0.9T, 1.2T, 1.5dci crossover SUV gen 1 (J87, J5, H5)	Rear	⊥ ⊖
<i>D7024 > D7024S</i>	OPEL	15-April 22	Mokka & Mokka X cross-over SUV FWD EX AWD [Facelift Aug '16] gen 1 (J13)	Rear	⊥ ⊖
<i>D7029 > D7029S</i>	SUZUKI	81- 87	SJ410, SJ413, SJ413-4, (leaf spring susp), MC Samurai 4X4	Front	⊥ ○
<i>D7029 > D7029S</i>	SUZUKI	88-04	Samurai SJ413, 4X4 (Leaf spring susp)	Front	⊥ ○
<i>D7034 > D7034S</i>	NISSAN	July'14-Sept 22	Qashqai SUV 1.2T, 1.5dci, 1.6dci 4x2 and 1.6dci 4x4 (J11)	Rear	⊖ ⊙
<i>D7034 > D7034S</i>	RENAULT	16-18	Kadjar 1.2, 1.5dCi 4x2 & AWD SUV (HA, HL)	Rear	⊥ ⊙
<i>D7639 > D7639S</i>	DAIHATSU	98-May'00	Terios 4x2 & 4x4 (J100) Generation One	Rear	○ ○
<i>D7640 > D7640S</i>	SSANGYONG	98-08	Korando K230EL, K320EL & K290TDi 4x4 (KJ) gen 2	Rear	⊥ ○
D7644S	SUZUKI	98-04	Grand Vitara 4x4 EX XL gen 2 (FT, GT)	Rear	⊥ ⊖
<i>D7699 ></i>	KIA	95-Sept'99	Sportage 4x4 & 4x2 Gen 1 (NB7 / FM)	Rear	⊥ ⊖
<i>D7704 > D7704S</i>	SSANGYONG	98-08	Korando K230EL, K320EL & K290TDi 4x4 (KJ) gen 2	Front	⊥ ⊖
D7705S	KIA	end 14-on	K2700 1.3 ton & K2500 1.0 ton LDV gen 4 facelift	Front	⊥ ⊖
D7705S	SUZUKI	98-Sept 18	Jimny SN413 (Rear Coil spring susp) JA33, JB33	Front	⊥ ⊖
D7706S	SUZUKI	98-Sept 18	Jimny SN413 (Rear Coil spring susp) JA33, JB33	Rear	○ ○
<i>D7708S</i>	JAGUAR	17-on	E-Pace crossover SUV 2.0 AWD (X540) EX elec susp	Rear	⊥ ⊖
<i><u>D7708S!</u></i>	LAND ROVER	2015-Feb 2020	Discovery Sport SUV MC facelift (L550) EX elec susp	Rear	⊥ ⊖
<i>D7841 > D7841S</i>	KIA	95-Sept'99	Sportage 4x4 & 4x2 Gen 1 (NB7 / FM)	Front	⊥ ⊗
<i>D8014 > D8014S</i>	HYUNDAI	01-07	Terracan 4x4 2.9 CRDi, 3.5 V6	Front	⊥ ⊖
<i>D8015 > D8015S</i>	HYUNDAI	01-07	Terracan 4x4 2.9 CRDi, 3.5 V6	Rear	⊥ T

Key

*	See important installation information on inside front cover
!	Excluding self-levelling suspension
"..."	Special order - phone 010 900 1850. 6-12 week waiting period

~	Imported
#	Internal bump stop
⊖	Steering damper

- It is recommended that all new shock absorbers are fitted in pairs
- Do not mix gas and non-gas units on the same axle
- **Bold** part numbers indicate heavy-duty shocks
- Underlined part numbers indicate parts not immediately available
- *Italic* part numbers followed by > indicate parts to be discontinued

Passenger and light commercial

Part number [numerical listing]

Part number	Make	Year	Application	Position	Mounting information
D8018S	MERCEDES-BENZ	98-05	ML270CDI, ML320, ML350, ML430 & ML500 4x4 (EXC) ML400Cdi & ML55 AMG (W163) (EXC) AMG and Elec susp	Front	⊥ ⊕
D8019S	TOYOTA	03-Oct '09	Prado J120 (5 door) / J125 (3 door) Series (EXC) elec susp) Std Height	Rear	⊥ ○
<i>D8020 > D8020S</i>	CHERY	08-Jan'14	Tiggo	Rear	⊥ ⊕
<i>D8020 > D8020S</i>	HYUNDAI	01-06	Santa Fe 4x2 & 4x4 Gen 1 (SM)	Rear	⊥ ⊕
<i>D8020 > D8020S</i>	SSANGYONG	07-12	Rexton I & II 270, 290TD, E320 4x4 SUV (Y250)	Rear	⊥ ⊕
D8021S	SSANGYONG	02-06	Rexton I & II 270, 290TD, E320 4x4 SUV (Y200)	Rear	⊥ ○
D8022 > D8022S	TOYOTA	98-07	Landcruiser 100 Series S/Wagon IFS, (EXC) Lexus IFS & Torsion Bars (EXC) elec susp) Std Height	Front	⊥ ⊕
<i>D8023 > D8023S</i>	TOYOTA	98-07	Landcruiser 100 Series S/Wagon IFS, (EXC) Lexus IFS & Torsion Bars (EXC) elec susp) Std Height	Rear	⊥ ⊕
D8024S	TOYOTA	03-Oct '09	Prado J120 (5 door) / J125 (3 door) Series (EXC) elec susp) Std Height	Front	⊥ ⊕
<i>D8026 > D8026R / D8027L</i>	KIA	03-06	Sorento 4x4 & 4x2 2.5 & 3.5 gen 1 (JC) (EXC) elec or self-leveling susp	Front	⊥ ⊕
<i>D8026 > D8026R / D8027L</i>	KIA	07-Oct '09	Sorento 4x4 & 4x2 2.5 & 3.8 gen 1 (JC) (EXC) elec or self-leveling susp	Front	⊥ ⊕
D8028S	KIA	03-06	Sorento 4x4 & 4x2 2.5 & 3.5 gen 1 (JC) (EXC) elec or self-leveling susp	Rear	⊕ ⊕
D8068S	NISSAN	05 - 15	Pathfinder 4x4 SUV (R51)	Rear	⊕ ⊕
D8069S	NISSAN	05 - 15	Pathfinder 4x4 SUV (R51)	Front	⊥ ⊕
D8070S	NISSAN	05-March 17	Navara 4x2 & 4x4 2.5 dCi, 3.0, 4.0 V6 LDV (D40) Std height	Front	⊥ ⊕
<i>D8071 > D8071S</i>	AUDI	06 - June'15	Q7 4x4 Quattro (EXC) sport or air susp) Gen one 4L (EXC) facelift	Rear	⊥ ⊕
<i>D8072 > D8072S</i>	PORSCHE	03-10	Cayenne 4x4 SUV (9PA)	Rear	⊥ ⊕
<i>D8072 > D8072S</i>	VOLKSWAGEN	04-10	Touareg 4x4 (EXC) Elec, air or sport susp (7L)	Rear	⊥ ⊕
D8079S	CHEVROLET	07-18	Captiva SUV 4x2 & 4x4 Gen 1 (EXC) facelift (C100) (EXC) Elec or air susp, or self leveling rear ie on Diesel	Rear	⊕ ⊕
<i>D8080 > D8080S</i>	BMW	10-Oct 15	X1 (E84) sDrive FWD	Rear	⊥ T
<i>D8080 > D8080S</i>	BMW	10-Oct 15	X1 (E84) xDrive AWD	Rear	⊥ T
<i>D8081 > D8081S</i>	MERCEDES-BENZ	06-May'12	M-Series ML320, ML350, ML500 4x4 (W164) (EXC) AMG & Elec susp)	Rear	⊥ ⊕
<i>D8082 > D8082S</i>	MERCEDES-BENZ	98-05	ML270CDI, ML320, ML350, ML430 & ML500 4x4 (EXC) ML400Cdi & ML55 AMG (W163) (EXC) AMG and Elec susp	Rear	⊥ ⊕
<i>D8343 > D8343S</i>	TOYOTA	97-'02	Prado J90 series 3 door SWB S/W (EXC) eye/eye rear mountings)	Rear	⊥ ○
<i>D8343 > D8343S</i>	TOYOTA	97-'02	Prado J95 series 5 door LWB S/W (EXC) eye/eye rear mountings)	Rear	⊥ ○
D8483S	NISSAN	98-17	Patrol S/W 4x4 GR I / GU I Y61 Series (Coil springs) (EXC) '02-on 3.0TDi & 4.8i GR II / GU II series Std height 14mm OD Studs	Front	⊥ T
D8483S	NISSAN	07 - on	Patrol 4.2D Pick-Up 4x4 LDV Leaf spring rear (Y61) 14mm OD Studs	Front	⊥ T
<i>D8644 > D8644S</i>	LAND ROVER	94-on April '02	Range Rover Pegasus gen 2 (P38A) Std & Air Susp	Front	⊕ T
<i>D8645 > D8645S</i>	LAND ROVER	94-on April '02	Range Rover Pegasus gen 2 (P38A) Std & Air Susp	Rear	⊕ T
D8976S	LAND ROVER	end 04-June 17	Discovery 3 & 4 Air susp (L319)	Front	⊥ ⊕
D8976S	LAND ROVER	05-12	Range Rover Sport air susp gen 1 (L320)	Front	⊥ ⊕
D8977S	LAND ROVER	end 04-June 17	Discovery 3 & 4 Air susp (L319)	Rear	⊥ ⊕
D8977S	LAND ROVER	05-12	Range Rover Sport air susp gen 1 (L320)	Rear	⊥ ⊕
D8977S	LAND ROVER	13-on	Range Rover Sport air susp gen 2 (L494) (EXC) SVR	Rear	⊥ ⊕
<i>D9004 > D9004A ></i>	SSANGYONG	06-12	Kyron 4x4 SUV with independent rear susp (EXC) 4x2 = special order)	Rear	⊥ ⊕
D9012S	TOYOTA	08-July 20	Landcruiser 200 Series S/Wagon (EXC) elec susp) St Height	Front	⊥ ⊕
D9014S	TOYOTA	Nov '09-Q1 '24	Prado J150 (EXC) elec susp) 3.0 GRJ150, 4.0 KDJ150 Std Height	Rear	⊥ ○
<i>D9016 > D9016S</i>	TOYOTA	Nov '09-Q1 '24	Prado J150 (EXC) elec susp) 3.0 GRJ150, 4.0 KDJ150 Std Height	Front	⊥ ⊕

Key









*	See important installation information on inside front cover
!	Excluding self-leveling suspension
"..."	Special order - phone 010 900 1850, 6-12 week waiting period

~	Imported
#	Internal bump stop
⊕	Steering damper

- It is recommended that all new shock absorbers are fitted in pairs
- Do not mix gas and non-gas units on the same axle
- **Bold** part numbers indicate heavy-duty shocks
- Underlined part numbers indicate parts not immediately available
- *Italic* part numbers followed by > indicate parts to be discontinued

Passenger and light commercial

Part number [numerical listing]

Part number	Make	Year	Application	Position	Mounting information
E1283 >	AUDI	02-08	 A4 Cabriolet MCI Sport susp	Rear	⊥ ⊖
E1387 >	AUDI	Late '12-20	A3 all Gen 3 (8V) MCI Sportback, Quattro, Sport Susp S3 S3 & Elec susp 11mm rod & 45mm btm sleeve OE Strut leg outer diam = 50mm	Rear	⊥ ⊖
E2030 >	BMW	94-02	728i, 730d, 735i, 740i & 750i & Limo (E38) S30 Air Susp. & elec susp)	Rear	⊗ ⊖
E4608 >	BMW	94-02	728i, 730d, 735i, 740i & 750i & Limo (E38) S30 Air Susp. & elec susp)	Front	
E4940 >	ALFA ROMEO	00-06	156 Sportwagon S30 GTA / elec susp / self leveling rears)	Rear	
E7001 >	FIAT	03-10	Stilo 1.6 Hatch	Front	
E7001 >	FIAT	03-10	Stilo 1.6 Multi Wagon	Front	
E8504 >	AUDI	11-19	A6 Sedan & Avant MCI Quattro S30 Air & Elec susp) C7 Typ 4G	Front	⊥ ⊗
G1037	CHEVROLET	11-18	Sonic sedan & hatch 1.4 & 1.6 (T300) S30 RS 1.4 Turbo	Rear	⊥ ○
G1037	FIAT	March '12-16	Punto 1.2, 1.3 JTD, 1.4 Hatch (199) MCI sport susp S30 turbo)	Rear	⊥ ○
G1037	FIAT	06-16	Grand Punto 1.2, 1.3, 1.4 & 1.9 (199)	Rear	⊥ ⊖
G1037	OPEL	Nov'07-Oct '15	Corsa Hatch S30 Lite, OPC and Sport) (D)	Rear	⊥ ⊖
G1060	TATA	04 - 16	Indica Hatch (V2) gen 1 MCI B-Line (Check front OE #'s, and if MCI or S30 ABS)	Rear	⊥ ⊖
G1061	OPEL	July '05-10	Zafira 1.6, 1.8, 1.9CDTi MPV (Exc OPC, Sport & Panoramic) (B)	Rear	⊖ ⊖
G1067	RENAULT	End 06-March '13	Clio 1.4, 1.5dCi & 1.6 S30 1.2, 2.0 Sport, R27, 2.0 RS) For 1.2 see Clio II above	Rear	⊥ ○
G1067	RENAULT	05 - 08	Modus 1.2, 1.4, 1.6 Hatch / mini MPV	Rear	⊥ ○
G1074	GWM	12-16	C10 1.5 Hatch	Rear	⊥ ○
G1074	TOYOTA	05 - Sept'11	Yaris Hatch & (Vios) Sedan (NBC2) gen 2 (XP90)	Rear	⊥ ○
G1074	TOYOTA	Oct '11- 19	Yaris Hatch 1.0, 1.3 & Sedan gen 3 (XP130)	Rear	⊥ ○
G1075	CITROEN	08-14	C1 1.0 & 1.4 HdI Gen 1 (PM)	Rear	⊥ ○
G1075	PEUGEOT	07-15	107 Hatch 1.0	Rear	⊥ ○
G1075	TOYOTA	11-Sept'15	Aygo hatch gen 1 (AB10)	Rear	⊥ ○
G1075	TOYOTA	Oct '15-21	Aygo hatch gen 2 (AB40) S30 Agya models	Rear	⊥ ○
G1080	SMART	03-07	ForTwo all 700cc MCI cabrio S30 Brabus (W450 gen 1)	Rear	○ ○
G1080	SMART	End 03-07	Roadster Passion Cabriolet & Roadster Pure & Pulse Coupe	Rear	○ ○
G1081	KIA	03-Feb'06	Rio 1.3, 1.5 gen 1 facelift (DC) S30 earlier models	Rear	⊖ ⊖
G1083	FIAT	08-on	500 0.9, 1.2, 1.4 (3 door) S30 Abarth / sport susp, "L" & "X" models (312)	Rear	○ ○
G1083	FORD	09-10	Ka 1.3 Hatch	Rear	○ ○
G1084	CHEVROLET	05-July'10	Spark (M200, M250) MCI Lite 2010-on	Rear	○ ○
G1084	CHEVROLET	Aug '10-17	Spark LITE (M200, M250)	Rear	○ ○
G1086	MINI	07-13	Mini One, Cooper, Cooper D, Cooper S, One D (R56,R57 Mk II) MCI cabriolet (R57) & sport	Rear	⊥ ⊖
G1086	MINI	08-14	Mini Clubman S/Wagon MCI sport (R55) mkl	Rear	⊥ ⊖
G1091	ALFA ROMEO	09-18	MiTo hatch 1.4, 1.4T, 1.6JTD S30 1.4T QV sport, 1.8T GTA & Elec susp)	Rear	⊥ ○
G1094	HYUNDAI	09-June'12	i30 Hatch (FD) gen 1 (bottom U bracket / No dust cover)	Rear	⊥ ⊗
G1094	HYUNDAI	July'12-16	i30 Hatch (GD) gen 2	Rear	⊥ ⊗
G1094	KIA	06-12	Carens MPV (UN)	Rear	⊥ ⊗
G1094	KIA	09-12	Cee'd hatch 2.0 3-door (ED)	Rear	⊥ ⊗
G1095	TOYOTA	07-March '13	Auris 1.4, 1.6, 1.8, 2.0 hatch (E150 / 330N) S30 TRD	Rear	⊥ ○
G1095	TOYOTA	April '13-19	Auris (E180)	Rear	⊥ ○
G1095	TOYOTA	Oct '07-13	 Corolla Sedan 1.4, 1.6, 1.8, 2.0D gen 10 (E140, E150, E152)	Rear	⊥ ○
G1095	TOYOTA	Feb 14-19	 Corolla Sedan 1.3, 1.4D, 1.6, 1.8 gen 11 "Professional" S30 Quest (E170 / E180)	Rear	⊥ ⊖
G1095	TOYOTA	14-19	 Corolla QUEST 1.6 gen 10 (E140, E150)	Rear	⊥ ○

Key

*	See important installation information on inside front cover
!	Excluding self-leveling suspension
"..."	Special order - phone 010 900 1850. 6-12 week waiting period

~	Imported
#	Internal bump stop
⊖	Steering damper

- It is recommended that all new shock absorbers are fitted in pairs
- Do not mix gas and non-gas units on the same axle
- **Bold** part numbers indicate heavy-duty shocks
- Underlined part numbers indicate parts not immediately available
- *Italic* part numbers followed by > indicate parts to be discontinued

Passenger and light commercial

Part number [numerical listing]

Part number	Make	Year	Application	Position	Mounting information
G1095	TOYOTA	Feb 19-on	 Corolla QUEST 1.8, gen 11 (E170/ E180)	Rear	⊥ ○
G1095	TOYOTA	April '09-May'16	Prius Hybrid (ZVW30, XW30) gen 3	Rear	⊥ ⊕
G1098	HONDA	06-Aug '16	 Civic 1.8, 2.2 Hatch Mk8 + Mk9 (FN, FK)  Type R & Tourer S/W	Rear	⊥ ⊕
G1098	HONDA	14-15	(S/W) Civic Tourer S/Wagon Mk9	Rear	⊥ ⊕
G1099	SMART	End 04-07	ForFour 1.3 Pulse & 1.5 Passion (W454 gen 1)	Rear	⊥ ○
G1101A	RENAULT	08-13	Twingo hatch 1.2, 1.5TD, gen 2,  RS Sport (CND)	Rear	⊥ ○
G1102	KIA	04-June'11	Picanto 1.0, 1.1 Hatch (SA / BA) gen 1	Rear	⊥ ○
G1102	KIA	July'11-June '17	Picanto 1.0, 1.2 Hatch (TA) gen 2	Rear	⊥ ○
<u>G1102</u>	KIA	July 17-on	Picanto 1.0, 1.2 Hatch (JA) gen 3	Rear	⊥ ⊕
G1105	RENAULT	08-Nov '20	Kangoo 2 MPV & minivan (Check OE front strut outer diameter & bottom bracket width for correct selection)	Rear	⊕ ⊕
G1108A	RENAULT	09-Aug 16	Megane III Hatch 1.2T, 1.4T, 1.6, 1.9dCi  2.0T GT, RS & Sport susp)	Rear	○ ○
G1108A	RENAULT	09-Aug 16	Megane III cc Coupe  Cabriolet & 2.0T GT, & RS)	Rear	○ ○
G1111	HYUNDAI	08-18	i10 Hatch gen 1 (PA)	Rear	○ ○
G1116	SUZUKI	End'08-March '14	SX4 2.0 4x2 SUV  OE raised susp (GY, EY, RW)	Rear	⊥ ⊕
G1116	SUZUKI	End'08-March '14	SX4 2.0 4x4 SUV (GY, EY, RW)	Rear	⊥ ⊕
G1118	CITROEN	April '08-18	Berlingo Multispace MPV & P/Van 800kg to 1000kg payload	Rear	○ ○
G1118	PEUGEOT	09-18	Partner 1.6, 1.6Hdi Tepee 8 seater gen 2 (B9)	Rear	⊕ ⊕
G1118	PEUGEOT	09-18	Partner 1.6, 1.6Hdi panel van gen 2, 800 – 1000kg payload (B9)	Rear	⊕ ⊕
G1131	SUZUKI	14-16	Splash 1.2 hatch	Rear	⊥ ○
G1131	SUZUKI	08-10	 Swift gen 1 (RS413, RS415, MZ, EZ)  AWD & Sport ZC31S	Rear	⊥ ⊕
G1134	NISSAN	12-23	 Almera 1.5 (N17)	Rear	⊥ ○
G1134	NISSAN	11-June 18	Micra (K13) gen 4	Rear	⊥ ○
G1136	BMW	04-09	Z4 2.0, 2.5 & 3.0  M-Tech 3.2M & Sport susp)	Rear	⊥ ⊕
<i>G1138 ></i>	HONDA	11-14	Ballade gen 5 (GM2, GM3)	Rear	⊥ ⊕
<i>G1148 ></i> G1148A	HYUNDAI	10-March '16	iX35 4x2 (LM) gen 2 (Bottom U bracket)	Rear	⊥ ⊗
<i>G1148 ></i> G1148A	KIA	Sept'10-March '16	Sportage 4x2 2.0, 2.4 Gen 3 (SL)	Rear	⊥ ⊗
G1150	HYUNDAI	10-March '16	iX35 4x4 (LM) gen 2	Rear	⊥ ⊕
<u>G1151A</u>	KIA	Sept'10-March '16	Sportage 4x4 2.0, 2.4 Gen 3 (SL)	Rear	⊥ ⊕
G1153	RENAULT	13-Sept '18	Duster 4x2 1.6, 1.5dci  Auto) gen 1 (HS)	Rear	⊥ ○
G1153	RENAULT	Oct 18-on	Duster 4x2 1.5dCi & 1.6 gen 2 (HM)	Rear	⊥ ○
G1154	CHEVROLET	09-18	Cruze J300 (gen one) & J400 (gen two) Sedan & Hatch  Sport susp,  OPC)	Rear	⊥ ○
G1154	OPEL	end 10-May 16	 Astra  OPC, GTC, Elec susp) (J)	Rear	⊥ ○
G1155  G1156 	MAZDA	08-12	Mazda 6  MPS gen 2 (GH)	Front	⊥ ⊗
G1157	MAZDA	08-12	Mazda 6  MPS gen 2 (GH)	Rear	○ ○
G1158	NISSAN	08-24	NP200 3/4 ton LDV	Rear	⊥ ○
G1167	MAZDA	Mid 09-Sept'14	Mazda 3 gen 2 (BL)  MPS, sport susp or AWD (36mm btm sleeve length)	Rear	⊥ ⊕
G1168	CITROEN	Dec '09-16	C3 II  DS3 & Sport) (SC) 46mm OD strut base	Rear	○ ○
G1168	CITROEN	Dec '09-16	C3 II  DS3 & Sport) (SC) 51mm OD strut base	Rear	○ ○
G1170	CITROEN	11-18	DS3 1.2 & 1.6 46mm OD strut base	Rear	○ ○
G1170	CITROEN	11-18	DS3 1.2 & 1.6 51mm OD strut base	Rear	○ ○
G1176	RENAULT	April '13-19	Clio 0.9, 1.2  Sport susp, RS)	Rear	⊥ ⊕

Key

*	See important installation information on inside front cover
!	Excluding self-levelling suspension
***	Special order – phone 010 900 1850, 6-12 week waiting period

~	Imported
#	Internal bump stop
⊕	Steering damper

- It is recommended that all new shock absorbers are fitted in pairs
- Do not mix gas and non-gas units on the same axle
- **Bold** part numbers indicate heavy-duty shocks
- Underlined part numbers indicate parts not immediately available
- *Italic* part numbers followed by > indicate parts to be discontinued

Passenger and light commercial

Part number [numerical listing]

Part number	Make	Year	Application	Position	Mounting information
G1177	PEUGEOT	Oct '12-19	208 1.0, 1.2T, 1.4, 1.6 Type 1, 2 & 3 susp (check front strut lower outer diamer) gen 1 (A9)	Rear	⊖ ⊖
G1177	PEUGEOT	Oct '12-19	208 1.4 Hdi, 1.6 GTi, 1.6 Hdi Type 3 susp (check front strut lower outer diamer & brake hose bracket) gen 1 (A9)	Rear	⊖ ⊖
G1177	PEUGEOT	Oct '12-20	208 1.4 Hdi, 1.6 16v Turbo GTi, 1.6 Hdi Type 4 susp (check front strut lower outer diamer & brake hose bracket) gen 1 (A9)	Rear	⊖ ⊖
G1181	OPEL	14-19	Adam 1.0T, 1.4 MC "S" (M13)	Rear	⊥ ○
G1214A	SUZUKI	11-18	  Swift 1.2, 1.4 gen 2 (AZG, FZ, NZ, ZC72S, ZC82S) EXC 1.6 Sport ZC32S & 4WD	Rear	⊥ ⊖
G1219	VOLVO	12-19	V40 Hatch MC T series	Rear	⊥ ○
G1219	VOLVO	12-19	V40 Cross Country MC T5 (4x2 only)	Rear	⊥ ○
G1220	VOLKSWAGEN	Oct '11-19	Jetta VI EXC V5 & Sport susp) 1B (A6) OE Strut leg bottom outer diam = 50mm 11mm Rod, Btm eye width 45mm	Rear	⊥ ⊖
G1221	TATA	Sept '08-16	Indica Vista Hatch gen 2 (V3) EXC B-Line	Rear	⊥ ⊖
G1225	RENAULT	March '14-20	Sandero 0.9 hatch EXC Stepway) (B8 gen 2)	Rear	⊥ ○
G1226	CHEVROLET	11-18	Orlando MPV (J309)	Rear	⊥ ○
G1227	FORD	13-19	Kuga 4x2 & 4x4 SUV (gen 2) DM2, C520	Rear	⊥ ⊖
G1228	FORD	15-17	B-Max Mini MPV 1.0 (JK)	Rear	⊥ ○
G1228	FORD	Nov 12-17	 Fiesta Sedan & Hatch Mk 6 facelift (EXC ST)	Rear	⊥ ⊖
G1228	FORD	Dec 15-18	Figgo Hatch & sedan 1.5 gen 2 (EXC Freestyle Cross)	Rear	⊥ ⊖
G1228	FORD	18-21	Figgo Hatch & sedan gen 3	Rear	⊥ ⊖
G1234	VOLVO	07-13	C30 Hatch	Rear	⊥ ○
G1234	VOLVO	June'04-Oct '12	S40 Sedan & V50 S/W MC T5 (Gen 2) No spring seat	Rear	⊥ ⊖
G1235	BMW	99 - Sept'01	318i & 320d (E46) EXC M3, cabrio, coupe, & sport susp)	Rear	⊗ ⊖
G1235	BMW	99 - Sept'01	320i, 323i, 325i & 328i (E46) (EXC M3, cabrio, coupe & sport susp)	Rear	⊗ ⊖
G1235	BMW	99- April '01	330i & 330d (E46) EXC M3, cabrio, coupe & sport)	Rear	⊗ ⊖
G1235	BMW	Sept'01- Feb'05	318i (E46) (EXC Compact, M3, cabrio, coupe, sport susp & S/W)	Rear	⊗ ⊖
G1235	BMW	Sept'01- Feb'05	320i, 320d, 325i (E46) (EXC Compact, M3, cabrio, coupe & sport susp)	Rear	⊗ ⊖
G1235	BMW	April '01- Feb'05	330i & 330d (E46) MC 325ti compact EXC M3, cabrio, coupe, sport susp & S/W)	Rear	⊗ ⊖
G1235	BMW	98-05	E46 - Sport Pack II for BMW OE Sport Susp MC Ci	Rear	⊗ ⊖
G1235	BMW	Nov'01-05	318ti Compact (E46) MC Sport susp	Rear	⊗ ⊖
G1235	BMW	Nov'01-05	325ti Compact (E46) MC Sport susp	Rear	⊗ ⊖
G1235	BMW	00- 05	318i, 320i, 325i Touring (E46) (EXC Sport susp)	Rear	⊗ ⊖
G1235	BMW	00-06	 330Ci Cabriolet (EXC Sport Pac II & M3) (E46)	Rear	⊗ ⊖
G1235	BMW	99-06	 325Ci, 330Ci Coupe (EXC Sport Pac II & M3) (E46)	Rear	⊗ ⊖
G1235	BMW	00-06	 325Ci, 330 Ci Coupe Sport Pac II (EXC M3) (E46)	Rear	⊗ ⊖
G1236	AUDI	99-April '03	A3 Quattro MC Sport Susp)	Rear	⊖ ⊖
G1236	AUDI	00-April '03	S3 Quattro EXC sport)	Rear	⊖ ⊖
G1236	AUDI	00-06	TT 1.8 Turbo Coupe & Roadster/Cabriolet (8N) Quattro EXC Sport Susp	Rear	⊖ ⊖
G1239	VOLKSWAGEN	Feb'10-19	 Polo Sedan, EXC Vivo, Gti, hatch - OE# = 6RF512011A, Shock body length 421mm (mk 5 model, 6V2)	Rear	⊥ ⊖
G1239	VOLKSWAGEN	20 - on	 Polo 1.6 Sedan OE# = 6RF512011A body length 421mm (mk 5 facelift)	Rear	⊥ ⊖
G1239	VOLKSWAGEN	10/02-1/10	CrossPolo & Vivo Maxx EXC Sport Susp (mk 4 9N3) OE# = 6RF512011A body length 421mm	Rear	⊥ ⊖
G1239	VOLKSWAGEN	11-18	CrossPolo & Vivo Maxx EXC Sport Susp (mk 5 6R) OE# = 6RF512011A body length 421mm	Rear	⊥ ⊖
G1240	PEUGEOT	14-21	 308 1.2T gen 2 (T9)	Rear	⊥ ○
G1241	CHEVROLET	Aug '10-17	Spark (M300) EXC Lite	Rear	⊥ ○
G1246	SUZUKI	09-15	Alto hatch 1.0 gen 7 (GF)	Rear	○ ○

Key

*	See important installation information on inside front cover
!	Excluding self-levelling suspension
"..."	Special order - phone 010 900 1850. 6-12 week waiting period

~	Imported
#	Internal bump stop
⊖	Steering damper

- It is recommended that all new shock absorbers are fitted in pairs
- Do not mix gas and non-gas units on the same axle
- **Bold** part numbers indicate heavy-duty shocks
- Underlined part numbers indicate parts not immediately available
- *Italic* part numbers followed by > indicate parts to be discontinued

Passenger and light commercial

Part number [numerical listing]

Part number	Make	Year	Application	Position	Mounting information
G1248	TOYOTA	12-20	Etios 1.5 EXC Etios Cross (AK10)	Rear	⊥ ⊕
G1248	TOYOTA	14-20	Etios Cross 1.5	Rear	⊥ ⊕
G1249	FIAT	09-14	Linea sedan 1.4 8v EXC T-Jet)	Rear	⊥ ○
<u>G1257</u>	CITROEN	16-on	C3 III (SX, SY)	Rear	⊕ ⊕
<u>G1257</u>	CITROEN	19-on	C3 Aircross SUV 1,2, 1,6 (2R, 2C)	Rear	⊕ ⊕
<u>G1257</u>	OPEL	17-on	Crossland & Crossland X 1,2T SUV (P17)	Rear	⊕ ⊕
G1259	NISSAN	95-early '00	Maxima QX (A32) EXC elec susp)	Rear	⊥ ○
G1264	ALFA ROMEO	94- 97	145 & 146 1.3, 1.6, 1.7 16v	Rear	⊕ ⊕
G1264	ALFA ROMEO	94- June 01	145 & 146 1.4TS, 1.6TS, 1.8TS, 1.9TDS & 2.0 TS	Rear	⊕ ⊕
G1264	ALFA ROMEO	91- 97	155 EXC 2500 V6, 2.5TD, 2.0 Turbo AWD, elec susp)	Rear	⊕ ⊕
G1264	ALFA ROMEO	91- 97	155 2500 V6, 2.5TD EXC elec susp)	Rear	⊕ ⊕
G1264	FIAT	03-10	Multipla MPV 1.6, 1.9JTD EXC Bi-power)	Rear	⊕ ⊕
G1264	FIAT	02-10	Palio Weekend S/Wagon Type PY & 1Y + gen 2 Type 2G & 2K 1.4	Rear	⊕ ⊕
G1266	HYUNDAI	June '14-July '20	Grand i10 Hatch 1,25 gen 2 (BA)	Rear	⊥ ○
G1272	SUZUKI	15-22	Celerio hatch 1.0 gen 2 (FE)	Rear	⊥ ⊕
G1282	DATSUN	2015-22	Go hatch EXC Go+ (7 seater)	Rear	○ ○
G1321	MITSUBISHI	June '07-'12	Outlander 2.4 SUV (Gen 2, GS platform) CW5W EXC '10-'12 Facelift models – (with S/Pan)	Rear	⊥ ⊕
G1321	MITSUBISHI	11-23	ASX SUV gen 1 (GA, W)	Rear	⊥ ⊕
<u>G1321</u>	CITROEN	13-17	C4 Aircross SUV 2.0, 1.6Hdi 4x2 & 4x4	Rear	⊥ ⊕
G1321	MITSUBISHI	end '12-April 23	Outlander 2.4 SUV (Gen 3 GF/GG/ZJ/ZK) [Facelift in 2015]	Rear	⊥ ⊕
<u>G1321</u>	PEUGEOT	12-16	4008 SUV	Rear	⊥ ⊕
G1337	RENAULT	March '04-end 09	Scenic II 1.6, 1.9dCi, 2.0	Rear	⊕ ⊕
G1337	RENAULT	end 09-16	Scenic III MPV 1.6, 1.9dCi	Rear	⊕ ⊕
G1339	AUDI	11-May 18	A1 Gen 1 (8X) EXC Sport susp (122 PS)	Rear	⊥ ⊕
G1339	AUDI	11-May '18	A1 Gen 1 (8X) Sport susp & 1.4 TFSI (185 PS)	Rear	⊥ ⊕
G1339	VOLKSWAGEN	Feb'10-Jan '18	 Polo Hatch GTi & Sport susp, EXC Vivo, Sedan & Cross (mk 5 model, 6R, 6C)	Rear	⊥ ⊕
G1339	VOLKSWAGEN	Feb'10-Feb '18	  Polo VIVO GT & Sport susp (mk 4 9N3) EXC Maxx	Rear	⊥ ⊕
G1339	VOLKSWAGEN	March 18-on	 Polo VIVO GT & Sport susp (mk 5 model, 6R, 6C) EXC Maxx	Rear	⊥ ⊕
G1339	VOLKSWAGEN	Oct '02-Jan'10	Polo Hatch & Classic Sedan GTi & Sport susp EXC CrossPolo (mk 4 9N3)	Rear	⊥ ⊕
G1345	FIAT	14-18	500L 1.4, 1.6 (5 door) EXC Std 500 models, "X" models. Abarth / sport susp (351 & 352)	Rear	⊥ ⊕
G1347	HYUNDAI	Feb'15-20	i20 Hatch (GB) gen 2 EXC "Active" that has increased ground clearance)	Rear	⊥ ⊕
<u>G1350</u>	HYUNDAI	18-20	i20 Hatch Active Crossover 1.4 (GB) gen 2 (has incr ground clearance) EXC i20N	Rear	⊥ ⊕
<u>G1351</u>	KIA	June 17 – on	Rio 1.2, 1.4 gen 3 (YB)	Rear	⊥ ⊕
G1364	VOLKSWAGEN	08-Sept 16	Tiguan 4 Motion AWD & FWD EXC Blue Motion EXC elec susp) gen 1 (5N)	Rear	⊥ ⊕
<u>G1368</u>	AUDI	00-06	TT 1.8 Turbo Coupe & Roadster/Cabriolet (8N) EXC Sport Susp & 3.2 V6 Quattro (8N)	Rear	⊥ ⊕
<u>G1377</u>	SUZUKI	16-April 22	Baleno hatch 1.4 (WB)	Rear	⊥ ⊕
<u>G1377</u>	SUZUKI	18-on	Dzire sedan 1.2 (gen 3)	Rear	⊥ ⊕
<u>G1377</u>	SUZUKI	18-on	  Swift 1.2 gen 3 (A2L, AZ) EXC 1,4T Sport rear	Rear	⊥ ⊕
<u>G1377</u>	TOYOTA	20-April '22	Starlet 1.4 gen 1 WB, SZ3 (based on Suzuki Baleno)	Rear	⊥ ⊕
<u>G1381</u>	MAZDA	15-on	CX-3 SUV 2,0 (DK)	Rear	⊥ ⊕
G1386	TOYOTA	17-23	C-HR 1.2T Cross-over Coupe (AX10)	Rear	⊥ ⊕
<u>G1387</u>	MAZDA	March '15-on	Mazda 2 (DJ) 1,3, 1,5	Rear	⊥ ⊕

Key

*	See important installation information on inside front cover
!	Excluding self-levelling suspension
"..."	Special order – phone 010 900 1850. 6-12 week waiting period

~	Imported
#	Internal bump stop
⊕	Steering damper

- It is recommended that all new shock absorbers are fitted in pairs
- Do not mix gas and non-gas units on the same axle
- **Bold** part numbers indicate heavy-duty shocks
- Underlined part numbers indicate parts not immediately available
- *Italic* part numbers followed by > indicate parts to be discontinued

Passenger and light commercial

Part number [numerical listing]

Part number	Make	Year	Application	Position	Mounting information
G1429	RENAULT	20 - on	Clio 1.0T (30) Sport	Rear	⊥ ⊖
G1430	RENAULT	20-on	Captur 1.0, 1.3T crossover SUV gen 2 (HF, JB, JE)	Rear	⊥ ⊖
G1439	HYUNDAI	18-23	Kona Cross-over SUV FWD 1.0T, 1.6T-Gdi & 2.0 gen 1 (OS)	Rear	⊥ ⊖
G16248 R G16249 L	HYUNDAI	96- Aug '00	Elantra Sedan & S/W gen 2 (J2)	Rear	⊥
G16248 R G16249 L	HYUNDAI	97- 02	Tiburon coupe (RD)	Rear	⊥
G16262 >	FORD	Mid 99 -03	 Fiesta 3 door 1.6 RSi & ST sport with power steering Mk4 facelift (JA, JB)	Front	⊥
G16275 R G16276 L	FORD	03-Oct '04	Focus 1.6 Hatch & Sedan Mkl DAW (30) 2.0 & St170)	Front	⊥
G16277	MERCEDES-BENZ	00-04	A160, A170CDi A190 (W168)	Front	⊥
G16289	TOYOTA	99-05	Yaris / Vitz Hatch 30) 1.5 T-Sport (Cross border - non RSA) gen 1 (XP10)	Front	⊥
G16312 R G16313 L	HYUNDAI	00-08	Atos & Atos Prime (FF/MX)	Front	⊥
G16318 > G16319 >	MAZDA	99- 00	Etude (Ch # up to -> ###304194) - J39 (BJ) No Bracket under S/Pan. Only at the bottom of strut.	Front	⊥
G16320 R G16321 L	MAZDA	99- 00	Etude (Ch # up to -> ###304194) - J39 (BJ)	Rear	⊥
G16320 R G16321 L	MAZDA	00 - 00	Etude (Ch ###304195 up to ->###400000) - J39 (BJ)	Rear	⊥
G16327 R > G16328 L >	OPEL	02-11	Combo Panel Van (C)	Front	⊥
G16327 R > G16328 L >	OPEL	03-09	Meriva 1.4, 1.6, 1.7CDTi, 1.8 mini MPV (A)	Front	⊥
G16345 R G16346 L	MAZDA	00 - 00	Etude (Ch ###304195 up to ->###400000) - J39 (BJ) Bracket under S/Pan	Front	⊥
G16345 R G16346 L	MAZDA	00-04	Etude (Ch # 's ###400001 - on ->) 30) front 2.0 26v (BJ) Bracket under S/Pan	Front	⊥
G16347 R G16348 L	MAZDA	00-04	Etude (Ch # 's ###400001 - on ->) 30) front 2.0 26v (BJ)	Rear	⊥
G16351 R G16352 L	HYUNDAI	Aug '00-Oct '06	Elantra Sedan & S/W gen 3 (XD)	Front	⊥
G16385 R G16386 L	FORD	04-Oct '08	 Fiesta Sedan & Hatch Mk 5 JH, JD 30) 2.0ST (30) 2.5 ST or RS) Oval spring	Front	⊥
G16385 R G16386 L	FORD	10-Nov 15	Figo Hatch 1.4 gen 1 Oval spring	Front	⊥
G16385 R G16386 L	FORD	07-15	Ikon sedan All	Front	⊥
G16387	RENAULT	03-08	Megane II Sedan & Hatch All 30) Shake it (30) 2.0 T Sport)	Front	⊥
G16387	RENAULT	June'04-08	 Megane II cc Coupe 1.6, 1.9dCi, 2.0	Front	⊥
G16387	RENAULT	June'04-08	 Megane II cc Cabriolet 1.6, 1.9dCi, 2.0	Front	⊥
G16446 R G16447 L	PEUGEOT	00-12	206 1.4, 1.6 XS, 1.6 XT, 2.0 HDi & 20 Gti Hatch (2A/C)	Front	⊥
G16446 R G16447 L	PEUGEOT	02-12	206 S/Wagon 1.6	Front	⊥
G16449 R G16450 L	CITROEN	04-11	C2 1.1i, 1.4i, 1.6i (30) Sport Susp) (JM)	Front	⊥
G16449 R G16450 L	CITROEN	02-May'06	C3 1.4i, 1.6i manual. 30) 1.6 auto, Hdi 80kw & 82kw 51mm OD strut base (FC / FN)	Front	⊥
G16449 R G16450 L	CITROEN	June'06-Nov'09	C3 (facelift) 1.4, 1.6 (FC / FN)	Front	⊥
G16449 R G16450 L	CITROEN	02-09	 C3 Pluriel & Enterprise models - Convertible (HB)	Front	⊥
G16449 R G16450 L	PEUGEOT	06-08	1007 Harch 1.6	Front	⊥
G16493 R G16494 L	MINI	01-06	Mini One, Cooper, Cooper S, One D (R50, R52, R53 Mk 1)	Front	⊥
G16507	MERCEDES-BENZ	83-94	190E 30) Sportline (201 Series)	Front	⊥
G16507	MERCEDES-BENZ	86-95	W124 30) E420, E500 30) all CE models C124 coupes. 30) Self leveling susp, S/W, Sportline & V124 limo (W124)	Front	⊥
G16507	MERCEDES-BENZ	86-95	S124 S/Wagon 230TE & 300TE 30) sport susp	Front	⊥

Key

*	See important installation information on inside front cover
!	Excluding self-leveling suspension
"..."	Special order - phone 010 900 1850. 6-12 week waiting period

~	Imported
#	Internal bump stop
⊖	Steering damper

- It is recommended that all new shock absorbers are fitted in pairs
- Do not mix gas and non-gas units on the same axle
- **Bold** part numbers indicate heavy-duty shocks
- Underlined part numbers indicate parts not immediately available
- *Italic* part numbers followed by > indicate parts to be discontinued

Passenger and light commercial

Part number [numerical listing]

Part number	Make	Year	Application	Position	Mounting information
G16555	HYUNDAI	91-95	Elantra gen 1 (J1)	Front	
G16690 R G16691 L	VOLVO	95- May'99	S40 Sedan & V40 S/W T4 and Sportline	Front	
G16694	VOLKSWAGEN	98-07	Sharan MPV (7M8, 7M9, 7M6)	Front	
G16762 R G16763 L	MAZDA	Mid 99-03	626 sedan (GF) [assembled in Zimbabwe]	Rear	
G16772 R > G16773 L >	BMW	99 - Sept'01	318i & 320d (E46) exc M3, cabrio, coupe, & sport susp)	Front	
G16772 R > G16773 L >	BMW	Sept'01- Feb'05	318i (E46) exc Compact, M3, cabrio, coupe, sport susp & S/W)	Front	
G16772 R > G16773 L >	BMW	Nov'01-05	318ti Compact (E46) inc Sport susp	Front	
G16772 R > G16773 L >	BMW	00- 05	318i Touring (E46) exc Sport susp)	Front	
G16783 R G16784 L	VOLVO	June'99-April '00	S40 Sedan & V40 S/W exc Sport & T4)	Front	
G16785 R G16786 L	VOLVO	June'99-April '00	S40 Sedan & V40 S/W T4	Front	
G16790 R G16791 L	OPEL	01-05	Zafira 1.6, 1.8, 1.9CDTi, 2.2 MPV exc 2.0 turbo & OPC) (A)	Front	
G16793 R G16794 L	NISSAN	95-early '00	Maxima QX (A32) exc elec susp)	Front	
G16822 R G16823 L	TOYOTA	96-01	Export Camry (Japan mnf) SXV20, MCV20, XV20 gen 5	Rear	
G16826	VOLVO	00-10	S60 Sedan gen 1 exc elec susp, Four-C, R 2.5 20V, AWD, Lowered & Nivomat Levelling Suspensions)	Front	
G16826	VOLVO	98-July'06	S80 Sedan gen 1 exc elec susp Four-C, Lowered & Nivomat Leveling Suspensions).	Front	
G16826	VOLVO	00-07	V70 S/Wagon Gen 2 exc elec susp, Four-C, R 2.5 20V, XC AWD, Lowered & Nivomat Levelling Suspensions)	Front	
G16826	VOLVO	00-July'07	XC70 SUV AWD gen 2 exc Four-C elec & self level suspension	Front	
G2101 >	VOLKSWAGEN	March '06-Sept'11	Jetta V exc V5 & Sport susp) 1K2 (A5). Strut leg bottom outer diam = 50mm	Rear	
G2108	CITROEN	10-13	C3 Picasso	Rear	
G2108	PEUGEOT	06-12	207 1.4 Hatch (For 1.4 Hdi check front strut OD is 47mm)	Rear	
G2108	PEUGEOT	06-12	207 1.6 Vti, 1.4 Hdi & 1.6 Hdi Hatch (For 1.4 Hdi check front strut OD is 51mm)	Rear	
G2108	PEUGEOT	June'07-12	207 Cabrio cc 1.6 THP Turbo	Rear	
G2108	PEUGEOT	Oct '12-20	208 1.4 Hdi, 1.6 16v Turbo GTi, 1.6 Hdi Type 5 susp (Top mtng 10x55 & btm mtng 12x48) gen 1 (A9)	Rear	
G2119	TOYOTA	06-09	Avensis 2.0, 2.0D, 2.2D, 2.4 (T250)	Rear	
G2121 >	KIA	May '07 - 14	Sedona MPV gen 2 (VQ)	Rear	
G2121 >	KIA	15-19	Sedona / Grand Sedona MPV gen 3 (YP)	Rear	
G2122	HYUNDAI	07-09	Santa Fe 4x2 & 4x4 Gen 2 (CM) exc elec or self-levelling susp)	Rear	
G2122	HYUNDAI	09-12	Santa Fe 4x2 & 4x4 Gen 2 (CM) exc elec or self-levelling susp)	Rear	
G2122	KIA	Nov'09 - '11	Sorento 4x4 & 4x2 gen 2 (XM). exc elec or self-levelling susp	Rear	
G2126	TOYOTA	04-Oct '09	Corolla Verso MPV (AR10)	Rear	
G2165	VOLKSWAGEN	13-23	Up hatch 1.0 inc Cross	Rear	
G21659	HYUNDAI	03-11	Getz (TB)	Rear	
G21663 >	KIA	99-04	Carnival MPV (KV-II / UP) gen 1	Rear	
G2174	NISSAN	11-19	Juke FWD (F15)	Rear	
G2175	NISSAN	11-19	Juke AWD (F15)	Rear	
G2179	NISSAN	14-on	NV200 panel van & 7 seater Combi MPV 1.6 & 1.5dci	Rear	
G2184	TOYOTA	Nov 09-12	Corolla Verso MPV (AR20, AUR20, ZCR20)	Rear	
G2217	PEUGEOT	08-14	308 1.2T, 1.6 & 1.6Hdi Hatch. exc S/W, Vti, GT, 1.6 Turbo 147kw & CC gen 1 (T7)	Rear	
G2217	PEUGEOT	08-14	308 1.6T, 1.6 Vti & GT Turbo & 2.0Hdi Turbo Hatch. exc S/W & CC gen 1 (T7)	Rear	

Key

*	See important installation information on inside front cover
!	Excluding self-levelling suspension
"..."	Special order - phone 010 900 1850. 6-12 week waiting period

~	Imported
#	Internal bump stop
	Steering damper

- It is recommended that all new shock absorbers are fitted in pairs
- Do not mix gas and non-gas units on the same axle
- **Bold** part numbers indicate heavy-duty shocks
- Underlined part numbers indicate parts not immediately available
- *Italic* part numbers followed by > indicate parts to be discontinued

Passenger and light commercial

Part number [numerical listing]

Part number	Make	Year	Application	Position	Mounting information
G2222	KIA	Aug '09-13	Cerato / Forte sedan, hatch & Koup (TD) gen 2	Rear	○ ○
G2222	KIA	10-13	Cerato Koup 2.0 Coupe (TD)	Rear	○ ○
G2223	HYUNDAI	Aug '11-20	  Accent IV i25 (RB)	Rear	○ ○
G2223	HYUNDAI	09-12	i20 Hatch (PB) gen 1	Rear	⊖ ⊖
G2223	HYUNDAI	13-Jan'15	i20 Hatch (PB) gen 1 – facelift	Rear	⊖ ⊖
G2223	KIA	Nov'11-May 17	Rio 1.2, 1.4, 1.6 gen 3 (UB)	Rear	⊖ ○
G2224	VOLVO	10-18	S60 Sedan, gen 2  elec susp & AWD	Rear	⊥ ⊖
G2224	VOLVO	11-18	V60 S/Wagon  Cross Country  elec susp & AWD	Rear	⊥ ⊖
G2224	VOLVO	Aug '07-15	XC70 SUV AWD 3.0 T6, 3.2, 2.4 D5 gen 3  elec susp	Rear	⊥ ⊖
G2224	VOLVO	07-10	V70 S/Wagon Gen 3  3.0 T6, 2.4 D5 & AWD, D5, T6, Four-C AWD, V70 R, Elec susp, XC 4WD	Rear	⊥ ⊖
G2224 †	VOLVO	Aug '06-14	S80 Sedan gen 2 ( elec susp, T6, Four-C, Lowered, sport & Nivomat Leveling Suspensions)	Rear	⊥ ⊖
G2227	HYUNDAI	13-Sept 18	Santa Fe 4X2 5 & 7 seater Gen 3 (DM)  elec or self-levelling susp	Rear	⊖ ⊖
G2227	KIA	12 – Feb'15	Sorento 4x2 gen 2 facelift (XM).  elec or self-levelling susp	Rear	⊖ ⊖
G2228	HYUNDAI	13-Sept 18	Santa Fe 4X4 5 & 7 seater Gen 3 (DM)  elec or self-levelling susp	Rear	⊖ ⊖
G2228	KIA	12 – Feb'15	Sorento 4x4 gen 2 facelift (XM).  elec or self-levelling susp	Rear	⊖ ⊖
G2229	HYUNDAI	Aug '11-June '16	Elantra Sedan gen 5 (MD)	Rear	⊖ ⊖
G2229	HYUNDAI	13-17	Veloster 3 door coupe (FS)	Rear	⊖ ⊖
G2229	KIA	13-18	Cerato / Forte sedan, hatch & Koup (YD) gen 2	Rear	⊖ ⊖
G2229	KIA	14-18	Cerato Koup 1.6T Coupe (YD)	Rear	⊖ ⊖
G2230	CITROEN	11-16	DS4 1.6, 2.0	Rear	⊥ ○
G2232	BMW	End 04-Oct '11	1 Series 116i, 118i, 120i, 130i & 120d  Sport Susp, xDrive & 135i Coupe)	Rear	⊥ T
G2232	BMW	End 04-Oct '11	1 Series 116i, 118i, 120i, 130i, 135i & 120d Sport Susp  std 135i Coupe  xDrive)	Rear	⊥ T
G2232	BMW	March '05-12	3 series (E90 & E91) 320i, 320d, 323i, 325i, 330d, 330i & 335i  Sport susp, M3, Cabrio & Coupe)	Rear	⊥ T
G2232	BMW	March '05-12	3 series Sport susp, (E90 & E91) 320i, 320d, 323i, 325i, 330d, 330i & 335i  M3, Cabrio & Coupe)	Rear	⊥ T
G2232	BMW	07-12	 330i, 335i Cabriolet (Std & Sport susp)  M3, Coupe) (E93)	Rear	⊥ T
G2232	BMW	07 – 12	 320i, 325i, 335i Coupe (Std & Sport susp)  M3, Cabrio) (E92)	Rear	⊥ T
G2238	MAHINDRA	16 – on	Pik-Up Single & D/C 4x2 & 4x4 LDV gen 1 facelift 12mm ID mtng top & btm. Closed 311mm & open 490mm	Rear	⊖ ⊖
G2241	PEUGEOT	09-17	3008 MPV Crossover 1.6, 1.6 T, 2.0 Hdi gen 1  self leveling susp) (T8 / OU)	Rear	⊥ ⊖
G2244	FIAT	16-on	Tipo 1.4 & 1.6 (356)	Rear	⊥ ⊖
G2246	AUDI	97-Jan'99	A6 Quattro sedan & Avant S/W  2.7 turbo, Allroad & 4.2 V8) Only up to -> chassis No's 4B#X#070 000	Rear	⊥ ⊖
G2246	AUDI	Feb'99-April '00	A6 Quattro sedan & Avant  2.7 turbo, Allroad & 4.2 V8) From chassis No's 4B#X#070 000 -> 4B#Y#200 000	Rear	⊥ ⊖
G2246	AUDI	97-April '00	A6 2.7 Quattro Turbo,  Allroad 4WD & 4.2 V8) Up to -> chassis No's 4B#Y#200 000	Rear	⊥ ⊖
G2246	AUDI	May'00-May'01	A6 Quattro sedan & Avant  Allroad & 4.2 V8)	Rear	⊥ ⊖
G2246	VOLKSWAGEN	99-05	 Passat Sedan 2.3 V5 & 2.8 4WD 4 Motion Syncro  Sport Susp) (B5)	Rear	⊥ ○
G2246	AUDI	June'01 – '04	A6 Quattro Sedan & Avant  All Road & 4.2 V8)  air susp)	Rear	⊥ ⊖
G2257	OPEL	18-on	Combo Cargo Panel Van & Life minibus 1,6TD (E)	Rear	⊖ ⊖
G2257	PEUGEOT	19-on	Partner panel van 1.2T, 1.5Hdi, 1.6Hdi gen 3, 1000kg payload (K9)	Rear	⊖ ⊖
G2258	OPEL	19-on	Vivaro 2.0TD Van (KO)	Rear	⊖ ⊖
G2258	OPEL	19-on	Zafira Life 2.0TD Minibus (KO)	Rear	⊖ ⊖
G22709	HYUNDAI	00-08	Atos & Atos Prime (FF/MX)	Rear	○ ○
G23101	MAZDA	03-07	Mazda 6  MPS gen 1 (GG)	Front	⊥ ⊗

Key



*	See important installation information on inside front cover
!	Excluding self-levelling suspension
“...”	Special order – phone 010 900 1850. 6-12 week waiting period

~	Imported
#	Internal bump stop
⊖	Steering damper

- It is recommended that all new shock absorbers are fitted in pairs
- Do not mix gas and non-gas units on the same axle
- **Bold** part numbers indicate heavy-duty shocks
- Underlined part numbers indicate parts not immediately available
- *Italic* part numbers followed by > indicate parts to be discontinued

Passenger and light commercial

Part number [numerical listing]

Part number	Make	Year	Application	Position	Mounting information
G2510	FIAT	11-22	Panda 0.9, 1.2 (301) AWD & 1.4 100HP) (319) mk4	Rear	⊖ ⊖
G2514	AUDI	08-Jan 16	  A4 Sedan & Avant (301) Sport susp, Quattro, Elec susp & S4) B8	Rear	⊥ ⊖
G2514 !	AUDI	08-Jan '16	A5 Sportback Coupe, Cabrio & Quattro (301) Sport Susp, S5 & RS5) (B7, B8)	Rear	⊥ ⊖
G2524	ALFA ROMEO	10-20	Giulietta (940) All	Rear	
G2525	FORD	13-on	EcoSport cross-over SUV 1.0T, 1.5, 1.5TDCi (Gen 2)	Rear	⊥ ⊖
<u>G2551</u>	VOLVO	17-23	V90 S/Wagon AWD (301) XC90, Cross Country	Rear	⊥ ⊖
<u>G2551</u>	VOLVO	17-23	V90 Cross Country S/Wagon (301) XC90	Rear	⊥ ⊖
<u>G2551</u>	VOLVO	Oct 18 – 23	XC60 AWD Cross Country SUV gen 2 (301) Recharge elec & self leveling susp	Rear	⊥ ⊖
<u>G2551</u>	VOLVO	Aug '15-on	XC90 AWD 2.5 T5 & 2.5 D5 Cross Country S/Wagon gen 2 (301) Elec or self lev susp)	Rear	⊥ ⊖
G3021	RENAULT	16-on	Kwid 1.0 SUV (BW)	Rear	⊥ ⊖
G4015	MAHINDRA	11-18	XUV 500 SUV 2.2	Rear	⊥ ⊖
G43140	MERCEDES-BENZ	95-July'02	W210 E230 & E270CDI, Std. Susp (301) S/W & Elec susp)	Rear	⊥ ⊖
G43141	CHRYSLER	04-08	Crossfire	Front	⊥ ⊖
G43141	MERCEDES-BENZ	96-Mid 04	SLK200, SLK200K & SLK230K (301) SLK320 (R170)	Front	⊥ ⊖
G43142	CHRYSLER	04-08	Crossfire	Rear	⊥ ⊖
G43142	MERCEDES-BENZ	96-Mid 04	SLK200, SLK200K & SLK230K (301) SLK320 (R170)	Rear	⊥ ⊖
<u>G43155</u>	MERCEDES-BENZ	June '14-June '21	W205 C class C180, C200, C220d, C250, C250d, C300 & C350e (301) S/Wagon, Elec susp, Self level susp, Coupe, 4-Matic, AMG & Sports susp)	Rear	⊥ ⊖
<u>G43155</u>	MERCEDES-BENZ	End '14-June '21	C Class Coupe and Cabrio (301) Sport susp & AMG)	Rear	⊥ ⊖
<u>G43155</u>	MERCEDES-BENZ	May 16 – April 23	W213 E200, E250, E220d, E350d, E400 (301) S/W, Coupe, Cabrio, AMG, sport susp, air susp, elec susp)	Rear	⊥ ⊖
<u>G43158</u>	MERCEDES-BENZ	May 16-April 23	W213 E200, E250, E220d, E350d, E400 (301) S/W, Coupe, Cabrio, AMG, sport susp, air susp, elec susp)	Front	⊥ ⊗
<u>G43160</u>	MERCEDES-BENZ	19-on	B200, B250 (W247) (multi-link axle)	Rear	⊥ ⊖
<u>G43160</u>	MERCEDES-BENZ	19-on	CLA200, CLA220d, CLA250 (C118) (301) Sport susp, (301) AMG & Elec susp	Rear	⊥ ⊖
<u>G43160</u>	MERCEDES-BENZ	Sept 18 – on	A200, A200d, A250 (W177) (301) Elec susp, AMG A35 & Sport susp (multi-link axle)	Rear	⊥ ⊖
<u>G43161</u>	MERCEDES-BENZ	Sept 18 – on	A200, A200d, A250 (W177) (301) Elec susp, AMG A35 & Sport susp (rigid axle)	Rear	⊥ ⊖
<u>G43161</u>	MERCEDES-BENZ	19-on	B200, B250 (W247) (rigid axle)	Rear	⊥ ⊖
G44002	FORD	17-22	 Fiesta Sedan & Hatch Mk 7 HJ, HF	Rear	⊖ ⊖
<i>G55016 ></i>	BMW	90-99	M3 (E36)	Rear	⊗ ⊖
<i>G55016 ></i>	BMW	93-99	 M3 (E36)	Rear	⊗ ⊖
G55019	RENAULT	96-Feb'04	Scenic 1.4 & 1.6 Manual (301) RX4)	Rear	⊖ ⊖
G55019	RENAULT	96- June'98	Scenic 1.6 Automatic, 1.9dCi, 2.0 (301) RX4)	Rear	⊖ ⊖
G55019	RENAULT	June'98-Feb'04	Scenic 1.6 Automatic, 1.9dCi, 2.0 (301) RX4)	Rear	⊖ ⊖
<i>G55022 > G43152</i>	RENAULT	01-09	Kangoo 1 Express minivan 1.4 & 1.5dCi (750kg payload, 4 rear torsion bars) (301) 4x4)	Rear	⊖ ⊖
G55023	VOLVO	00-10	S60 Sedan gen 1 (301) elec susp, Four-C, R 2.5 20V, AWD, Lowered & Nivomat Levelling Suspensions)	Rear	⊥ ⊖
G55023	VOLVO	00-07	V70 S/Wagon Gen 2 (301) elec susp, Four-C, R 2.5 20V, XC AWD, Lowered & Nivomat Levelling Suspensions)	Rear	⊥ ⊖
G55023	VOLVO	00-July'07	XC70 SUV AWD gen 2 (301) Four-C elec & self level suspension	Rear	⊥ ⊖
G55023 !	VOLVO	98-July'06	S80 Sedan gen 1 (301) elec susp Four-C, Lowered & Nivomat Leveling Suspensions). Check chassis # for correct model year	Rear	⊥ ⊖
<u>G7019</u> R <u>G7020</u> I	CITROEN	08-14	C1 1.0 & 1.4 Hdi Gen 1 (PM)	Front	
<u>G7019</u> R <u>G7020</u> I	PEUGEOT	07-15	107 Hatch 1.0	Front	
<u>G7019</u> R <u>G7020</u> I	TOYOTA	11-Sept'15	Aygo hatch gen 1 (AB10)	Front	
<u>G7019</u> R <u>G7020</u> I	TOYOTA	Oct '15-21	Aygo hatch gen 2 (AB40) (301) Agya models	Front	

Key

*	See important installation information on inside front cover
!	Excluding self-levelling suspension
"..."	Special order – phone 010 900 1850. 6-12 week waiting period

~	Imported
#	Internal bump stop
⊖	Steering damper

- It is recommended that all new shock absorbers are fitted in pairs
- Do not mix gas and non-gas units on the same axle
- **Bold** part numbers indicate heavy-duty shocks
- Underlined part numbers indicate parts not immediately available
- *Italic* part numbers followed by > indicate parts to be discontinued



Passenger and light commercial

Part number [numerical listing]

Part number	Make	Year	Application	Position	Mounting information
G7023  G7024 	HYUNDAI	08-18	i10 Hatch gen 1 (PA)	Front	
G7025  G7026 	KIA	04-June'11	Picanto 1.0, 1.1 Hatch (SA / BA) gen 1	Front	
G7027  G7028 	NISSAN	12-23	 Almera 1.5 (N17)	Front	
G7027  G7028 	NISSAN	11-June 18	Micra (K13) gen 4 (small spring pan with stabi bar bkt)	Front	
G7086	SMART	03-07	ForTwo all 700cc  cabrio  Brabus (W450 gen 1)	Front	
G7086	SMART	End 03-07	Roadster Passion Cabriolet & Roadster Pure & Pulse Coupe	Front	
G7097  G7098 	CHEVROLET	05-July'10	Spark (M200, M250)  Lite 2010-on	Front	
G7097  G7098 	CHEVROLET	Aug '10-17	Spark LITE (M200, M250)	Front	
G7104	SMART	08-14	ForTwo all 1.0  cabrio  Brabus (W451 gen 2)	Front	
G7106  G7107 	KIA	July'11-June '17	Picanto 1.0, 1.2 Hatch (TA) gen 2	Front	
G7112	VOLKSWAGEN	13-23	Up hatch 1.0  Cross	Front	
G7115  G7116 	HYUNDAI	09-12	i20 Hatch (PB) gen 1	Front	
G7117  G7118 	HYUNDAI	13-Jan'15	i20 Hatch (PB) gen 1 – facelift	Front	
G7203	RENAULT	08-12	Logan sedan (U90)	Front	
G7203	RENAULT	09-Feb'14	Sandero hatch  Stepway) (B90 / BS gen 1)	Front	
G7204  G7205 	CITROEN	05-Oct '10	C4 (Gen 1) 1.6i, 2.0i, 2.0Hdi  Coupe  DS4 & sport susp)	Front	
G7265  G7266 	PEUGEOT	02-10	 (S/W) 307 1.6 & 2.0 hatch & 2.0 S/Wagon  cc)	Front	
G7265  G7266 	PEUGEOT	March '04-10	 307 CC Cabrio	Front	
G7271  G7272 	HONDA	03-04	Jazz 1.4 Dsi & 1.5 Vtec gen 1 (GD)	Front	
G7273  G7274 	SUZUKI	14-16	Splash 1.2 hatch	Front	
G7273  G7274 	SUZUKI	08-10	 Swift gen 1 (RS413, RS415, MZ, EZ)  AWD & Sport ZC31S	Front	
G7275  G7276 	HONDA	05-07	Jazz 1.4 Dsi & 1.5 Vtec gen 1 (GD facelift)	Front	
G7277	RENAULT	End 06-March '13	Clio 1.4, 1.5dCi & 1.6  1.2, 2.0 Sport, R27, 2.0 RS) For 1.2 see Clio II above	Front	
G7277	RENAULT	April '13-19	Clio 0.9, 1.2  Sport susp, RS)	Front	
G7277	RENAULT	05 – 08	Modus 1.2, 1.4, 1.6 Hatch / mini MPV	Front	
G7288  G7289 	CHEVROLET	03-09	Optra J200	Rear	
G7292  G7293 	NISSAN	04-10	Micra (K12E) gen3 (large spring pan)	Front	
G7294  G7295 	TOYOTA	05 – Sept'11	Yaris Hatch & (Vios) Sedan (NBC2) gen 2 (XP90)	Front	
G7294  G7295 	TOYOTA	Oct '11- 19	Yaris Hatch 1.0, 1.3 & Sedan gen 3 (XP130)	Front	
G7298  G7299 	HYUNDAI	02-10	Matrix Mini MPV (FC)	Rear	
G7303  G7304 	FORD	Nov'08-Oct '12	 Fiesta Sedan & Hatch Mk 6 CB1, CCN ( 1.6 ST)	Front	
G7303  G7304 	FORD	Dec 15-18	Figo Hatch & sedan 1.5 gen 2 ( Freestyle Cross)	Front	
G7305  G7306 	FIAT	08-on	500 0.9, 1.2, 1.4 (3 door)  Abarth / sport susp, "L" & "X" models (312)	Front	
G7305  G7306 	FORD	09-10	Ka 1.3 Hatch	Front	
G7323  G7324 	CITROEN	April '08-18	Berlingo Multispace MPV & P/Van 800kg to 1000kg payload	Front	
G7323  G7324 	PEUGEOT	09-18	Partner 1.6, 1.6Hdi Tepee 8 seater gen 2 (B9)	Front	

Key

	See important installation information on inside front cover
	Excluding self-leveling suspension
	Special order – phone 010 900 1850. 6-12 week waiting period

	Imported
	Internal bump stop
	Steering damper

- It is recommended that all new shock absorbers are fitted in pairs
- Do not mix gas and non-gas units on the same axle
- **Bold** part numbers indicate heavy-duty shocks
- Underlined part numbers indicate parts not immediately available
- *Italic* part numbers followed by > indicate parts to be discontinued

Passenger and light commercial

Part number [numerical listing]

Part number	Make	Year	Application	Position	Mounting information
67323  67324 	PEUGEOT	09-18	Partner 1.6, 1.6Hdi panel van gen 2, 800 – 1000kg payload (B9)	Front	
67329  67330 	PEUGEOT	08-14	 308 1.2T, 1.6 & 1.6Hdi Hatch.  S/W, Vti, GT, 1.6 Turbo 147kw & CC gen 1 (T7)	Front	
67329  67330 	PEUGEOT	08-10	(S/W) 308 1.6 S/Wagon  1.6T gen 1 (T7)	Front	
67338  67339 	HYUNDAI	09-June'12	i30 Hatch (FD) gen 1	Front	
67363  67364 	SMART	End 04-07	ForFour 1.3 Pulse & 1.5 Passion (W454 gen 1)	Front	
67369	NISSAN	08-24	NP200 3/4 ton LDV	Front	
67372	RENAULT	13-Sept '18	Duster 4x2 1.6, 1.5dci ( Auto) gen 1 (HS)	Front	
67372	RENAULT	13-Sept '18	Duster 4x4 1.6, 1.5dci ( Auto) gen 1 (HS)	Front	
67372	RENAULT	Oct 18-on	Duster 4x2 1.5dCi & 1.6 gen 2 (HM)	Front	
67372	RENAULT	Oct 18-on	Duster 4x4 1.5dCi gen 2 (HM)	Front	
67373	RENAULT	13-Sept '18	Duster 4x2 1.6, 1.5dci (Auto) gen 1 (HS)	Front	
67384  67385 	KIA	Aug '09-13	Cerato / Forte sedan, hatch & Koup (TD) gen 2	Front	
67384  67385 	KIA	10-13	Cerato Koup 2.0 Coupe (TD)	Front	
67386	RENAULT	13-Sept '18	Duster 4x4 1.6, 1.5dci ( Auto) gen 1 (HS)	Rear	
67386	RENAULT	Oct 18-on	Duster 4x4 1.5dCi gen 2 (HM)	Rear	
67396	RENAULT	March '04-end 09	Scenic II 1.6, 1.9dCi, 2.0	Front	
67396	RENAULT	Sept'04-end 09	Grand Scenic II (LWB) 1.9dCi, 2.0	Front	
67398  67399 	TOYOTA	06-11	Avanza 1.3, 1.5 MPV & Panel Van  &  ABS (F600) Gen 1  facelift	Front	
67401  67402 	MAZDA	07-Feb'15	Mazda 2 (DE)	Front	
67413  67414 	OPEL	14-19	Adam 1.0T, 1.4  "S" (M13)	Front	
67419  67420 	KIA	Nov'11-May 17	Rio 1,6 gen 3 (UB) 12mm ID camber bolt holes	Front	
67421  67422 	KIA	Nov'11-May 17	Rio 1.2, 1.4 gen 3 (UB) 14mm ID camber bolt holes /	Front	
67431  67432 	NISSAN	14-on	NV200 panel van & 7 seater Combi MPV 1.6 & 1.5dci	Front	
67451  67452 	SUZUKI	11-18	  Swift 1.2, 1.4 gen 2 (AZG, FZ, NZ, ZC72S, ZC82S)  1.6 Sport ZC32S & 4WD	Front	
67456 (std ht)	RENAULT	March '14-20	Sandero 0.9 hatch ( Stepway) (B8 gen 2)	Front	
67457	RENAULT	March '14-20	Sandero 0.9 Stepway (B8 gen 2)	Front	
67468  67469 	CHEVROLET	11-18	Sonic sedan & hatch 1.4 & 1.6 (T300)  RS 1.4 Turbo	Front	
67473  67474 	HONDA	May'11-Aug '16	 Civic Sedan Mk9 (FB, FG)	Front	
67479	TOYOTA	12-20	Etios 1.5  Etios Cross (AK10)	Front	
67479	TOYOTA	14-20	Etios Cross 1.5	Front	
67483  67484 	CHEVROLET	Aug '10-17	Spark (M300)  Lite	Front	
67486	RENAULT	99-06	Clio 1.6 16v Sport ( 2.0 16v Sport & 3.0 V6 mid engine)	Front	
67511  67512 	SUZUKI	End'08-March '14	SX4 2.0 4x4 SUV (GY, EY, RW)	Front	
67513  > 67514  >	BMW	Sept'01- Feb'05	320i, 320d, 325i (E46) ( Compact, M3, cabrio, coupe & sport susp)	Front	
67513  > 67514  >	BMW	99-Sept'01	 325Ci, 330Ci Coupe ( Sport Pac II & M3) (E46)	Front	
67607	MINI	11-16	Mini Countryman SUV Crossover  AWD (R60) mkl	Rear	
67607	MINI	13-16	Mini Paceman 2 door crossover (R61)	Rear	

Key















































































































*	See important installation information on inside front cover
!	Excluding self-leveling suspension
"..."	Special order – phone 010 900 1850. 6-12 week waiting period

~	Imported
#	Internal bump stop
⊕	Steering damper

- It is recommended that all new shock absorbers are fitted in pairs
- Do not mix gas and non-gas units on the same axle
- **Bold** part numbers indicate heavy-duty shocks
- Underlined part numbers indicate parts not immediately available
- *Italic* part numbers followed by > indicate parts to be discontinued



Passenger and light commercial

Part number [numerical listing]

Part number	Make	Year	Application	Position	Mounting information
G7780  G7781 	HYUNDAI	Feb'15-20	i20 Hatch (GB) gen 2  "Active" that has increased ground clearance)	Front	
G7911  G7912 	SUZUKI	16-April '22	Baleno hatch 1.4 (WB)  models with raised ground clearance)	Front	
G7911  G7912 	TOYOTA	20-April '22	Starlet 1.4 gen 1 WB, SZ3 (based on Suzuki Baleno)	Front	
G7923  G7924 	HYUNDAI	June'14-July '20	Grand i10 Hatch 1,25 gen 2 (BA)	Front	
G7931  G7932 	BMW	13-18	X5 (F15) 3.5i xDrive, 5.0i V8 xDrive, 3.0d xDrive, 4.0d xDrive 4x4,  Self Leveling & sport susp  Mtech M50d or Elec susp)	Rear	
G7931  G7932 	BMW	Feb'15-on	X6 (F16) Cross-over SUV	Rear	
G7933	VOLVO	Oct 18 - 23	XC60 AWD Cross Country SUV gen 2  Recharge elec & self leveling susp	Front	
G7933	VOLVO	Aug '15-on	XC90 AWD 2.5 T5 & 2.5 D5 Cross Country S/Wagon gen 2  Elec or self lev susp)	Front	
G7934	VOLVO	17-23	S90 Sedan gen 2  elec or self level susp	Front	
G7934	VOLVO	17-23	V90 S/Wagon  XC90, Cross Country	Front	
G7934	VOLVO	17-23	V90 Cross Country S/Wagon  XC90	Front	
G7942  G7943 	MAZDA	March '15-on	Mazda 2 (DJ) 1,3, 1,5	Front	
G7944	BMW	13-18	X5 (F15) 3.5i xDrive, 5.0i V8 xDrive, 3.0d xDrive, 4.0d xDrive 4x4,  Self Leveling & sport susp  Mtech M50d or Elec susp)	Front	
G7944	BMW	Feb'15-on	X6 (F16) Cross-over SUV	Front	
G7986  G7987 	SUZUKI	18-on	Dzire sedan 1.2 (gen 3)	Front	
G7986  G7987 	SUZUKI	18-on	  Swift 1.2 gen 3 (AZL, AZ)  1.4T Sport rear	Front	
G8001  G8002 	OPEL	Sept'04-09	 Astra 1.4 & 1.6 (model H)	Front	
G8003  G8004 	OPEL	Sept'04-09	 Astra 1.8, & 1.9 CDTi  GTC  elec susp (model H)	Front	
G8003  G8004 	OPEL	07-10	Astra Twintop 1.8 & 2.0 	Front	
G8003  G8004 	OPEL	July '05-10	Zafira 1.6, 1.8, 1.9CDTi MPV (Exc OPC, Sport & Panoramic) (B)	Front	
G8005 >	VOLKSWAGEN	04 - May 15	Caddy All gen 3 (2K) 50mm OD strut tube	Front	
G8007  G8008 	CITROEN	03-April '08	Berlingo Multispace MPV & P/Van	Front	
G8007  G8008 	CITROEN	01-05	Xsara II 1,4	Front	
G8007  G8008 	PEUGEOT	Nov'02-08	Partner Grand Raid MPV 1.9D (DW8B) & 2.0 Hdi (DW10TD) gen 1 (600kg payload) (5F)	Front	
G8007  G8008 	PEUGEOT	11/02-08	Partner Panel Van 1.9D gen 1 (800kg payload)	Front	
G8007  G8008 	CITROEN	01-07	Xsara Picasso MPV	Front	
G8019	ALFA ROMEO	June'01-10	147 1.6TS, 1.9JTD & 2.0TS hatch	Rear	
G8063  G8064 	FIAT	09-14	Linea sedan 1.4 8v  T-Jet)	Front	
G8063  G8064 	FIAT	March '12-16	Punto 1.2, 1.3 JTD, 1.4 Hatch (199)  sport susp  turbo)	Front	
G8063  G8064 	FIAT	06-16	Grand Punto 1.2, 1.3, 1.4 & 1.9 (199)	Front	
G8063  G8064 	OPEL	Nov'07-Oct '15	Corsa Hatch  Lite, OPC and Sport) (D)	Front	
G8089  G8090 	CHEVROLET	03-09	Optra J200	Front	
G8091  G8092 	TOYOTA	06-09	Avensis 2.0, 2.0D, 2.2D, 2.4 (T250)	Front	
G8095  G8096 	MINI	07-13	Mini One, Cooper, Cooper D, Cooper S, One D (R56,R57 Mk II)  cabriolet (R57) & sport	Front	
G8095  G8096 	MINI	08-14	Mini Clubman S/Wagon  sport (R55) mkl	Front	

Key

* 	See important installation information on inside front cover
! 	Excluding self-leveling suspension
"..." 	Special order - phone 010 900 1850. 6-12 week waiting period

~ 	Imported
# 	Internal bump stop
⊕ 	Steering damper

- It is recommended that all new shock absorbers are fitted in pairs
- Do not mix gas and non-gas units on the same axle
- **Bold** part numbers indicate heavy-duty shocks
- Underlined part numbers indicate parts not immediately available
- *Italic* part numbers followed by > indicate parts to be discontinued

Passenger and light commercial

Part number [numerical listing]

Part number	Make	Year	Application	Position	Mounting information
G8097  G8098 	PEUGEOT	06-12	207 1.4 Hatch (For 1.4 Hdi check front strut OD is 47mm)	Front	
G8099  G8100 	CITROEN	10-13	C3 Picasso	Front	
G8099  G8100 	PEUGEOT	06-12	207 1.6 Vti, 1.4 Hdi & 1.6 HDi Hatch (For 1.4 Hdi check front strut OD is 51mm)	Front	
G8099  G8100 	PEUGEOT	06-12	207 1.6 Gti T Hatch Btm Strut body OD = 51mm	Front	
G8099  G8100 	PEUGEOT	June '07-12	207 Cabrio cc 1.6 THP Turbo Btm Strut body OD = 51mm	Front	
G8110	FIAT	07-15	Bravo (198 generation II) 1.4, 1.9  sport susp)	Front	
G8112  G8113 	ALFA ROMEO	09-18	MiTo hatch 1.4, 1.4T, 1.6JTD  1.4T QV sport, 1.8T GTA & Elec susp)	Front	
G8114	MERCEDES-BENZ	05-12	A170, A180CDi, A200 (W169)	Front	
G8117  G8118 	TOYOTA	March '06 -12	RAV4 (XA30) gen 3	Front	
G8117  G8118 	TOYOTA	13-Feb 19	RAV4 (XA40) gen 4	Front	
G8119  G8120 	TOYOTA	07-March '13	Auris 1.4, 1.6, 1.8, 2.0 hatch (E150 / 330N)  TRD	Front	
G8119  G8120 	TOYOTA	April '13-19	Auris (E180)	Front	
G8119  G8120 	TOYOTA	Oct '07-13	 Corolla Sedan 1.4, 1.6, 1.8, 2.0D gen 10 (E140, E150, E152)	Front	
G8119  G8120 	TOYOTA	Feb 14-19	 Corolla Sedan 1.3, 1.4D, 1.6, 1.8 gen 11 "Profesional"  Quest (E170 / E180)	Front	
G8119  G8120 	TOYOTA	14-19	 Corolla QUEST 1.6 gen 10 (E140, E150)	Front	
G8119  G8120 	TOYOTA	Feb 19-on	 Corolla QUEST 1.8, gen 11 (E170/ E180)	Front	
G8121  G8122 	TOYOTA	04-Oct '09	Corolla Verso MPV (AR10)	Front	
G8127  G8128 	PEUGEOT	08-14	 308 1.6T, 1.6 Vti & GT Turbo & 2.0Hdi Turbo Hatch.  S/W & CC gen 1 (T7)	Front	
G8127  G8128 	PEUGEOT	09-14	 308 Cabrio cc 1.6 T gen 1 (T7)	Front	
G8147  G8148 	CITROEN	02-May'06	C3 1.6i 16v auto & Hdi 80kw & 82kw  46mm OD strut base. (FC / FN)	Front	
G8149	RENAULT	09-Aug 16	Megane III Hatch 1.2T, 1.4T, 1.6, 1.9dCi  2.0T GT, RS & Sport susp)	Front	
G8149	RENAULT	09-Aug 16	Megane III cc Coupe  Cabriolet & 2.0T GT, & RS)	Front	
G8150  G8151 	HYUNDAI	07-09	Santa Fe 4x2 & 4x4 Gen 2 (CM)  elec or self-levelling susp)	Front	
G8163  G8164 	BMW	04-09	Z4 2.0, 2.5 & 3.0  M-Tech 3.2M & Sport susp)	Front	
G8169  G8170 	HONDA	06-Aug '16	 Civic 1.8, 2.2 Hatch Mk8 + Mk9 (FN, FK)  Type R & Tourer S/W	Front	
G8171  G8172 	FORD	Aug '11-15	Focus 1.0, 1.5, 1.6, 2.0Si, 2.0TDCi & TDCi Si,  2.0ST front only, Hatch and Sedan MkIII C346  2.0ST rear, RS, & facelift models)	Front	
G8173	RENAULT	08-Nov '20	Kangoo 2 MPV & minivan (Check OE front strut outer diameter 52mm & bttm bracket 35mm wide)	Front	
G8176  G8177 	HYUNDAI	10-March '16	iX35 4x2 (LM) gen 2	Front	
G8176  G8177 	HYUNDAI	10-March '16	iX35 4x4 (LM) gen 2	Front	
G8176  G8177 	KIA	Sept'10-March '16	Sportage 4x2 2.0, 2.4 Gen 3 (SL)	Front	
G8176  G8177 	KIA	Sept'10-March '16	Sportage 4x4 2.0, 2.4 Gen 3 (SL)	Front	
G8195  G8196 	CHEVROLET	09-18	Cruze J300 (gen one) & J400 (gen two) Sedan & Hatch  Sport susp,  OPC)	Front	
G8195  G8196	CHEVROLET	11-18	Orlando MPV (J309)	Front	
G8195 G8196	OPEL	end 10-May 16	Astra OPC, GTC, Elec susp) (J)	Front	
G8198 G8199	VOLVO	Aug '06-'14	S80 Sedan gen 2 elec susp, T6, Four-C, Lowered, sport & Nivomat Leveling Suspensions)	Front	

Key

*	See important installation information on inside front cover
!	Excluding self-levelling suspension
...	Special order - phone 010 900 1850. 6-12 week waiting period

~	Imported
#	Internal bump stop
⊕	Steering damper

- It is recommended that all new shock absorbers are fitted in pairs
- Do not mix gas and non-gas units on the same axle
- **Bold** part numbers indicate heavy-duty shocks
- Underlined part numbers indicate parts not immediately available
- *Italic* part numbers followed by > indicate parts to be discontinued

Passenger and light commercial

Part number [numerical listing]

Part number	Make	Year	Application	Position	Mounting information
G8198 G8199	VOLVO	Aug '06-'14	S80 Sedan T6 AWD gen 2 All elec susp, Lowered & Nivomat Leveling Suspensions)	Front	
G8198 G8199	VOLVO	07-10	V70 S/Wagon Gen 3 D5, T6, Four-C AWD, V70 R, Elec susp, XC 4WD	Front	
G8198 G8199	VOLVO	Aug '07-15	XC70 SUV AWD 3.0 T6. 3.2, 2.4 D5 gen 3 elec susp	Front	
G8204 G8205	CITROEN	Dec '09-16	C3 II DS3 & Sport) (SC) 46mm OD strut base	Front	
G8204 G8205	CITROEN	11-18	DS3 1.2 & 1.6 46mm OD strut base	Front	
G8206 G8207	CITROEN	Dec '09-16	C3 II DS3 & Sport) (SC) 51mm OD strut base	Front	
G8206 G8207	CITROEN	11-18	DS3 1.2 & 1.6 51mm OD strut base	Front	
G8212 > G8213 >	BMW	End 04-Oct '11	1 Series 116i,118i, 120i, 130i & 120d Sport Susp, xDrive & 135i Coupe)	Front	
G8212 > G8213 >	BMW	March '05-12	3 series (E90 & E91) 320i, 320d, 323i, 325i, 330d, 330i & 335i Sport susp, M3, Cabrio & Coupe)	Front	
G8216 G8217	HYUNDAI	July '12-16	i30 Hatch (GD) gen 2	Front	
G8218 G8219	HYUNDAI	13-Sept 18	Santa Fe 4X2 5 & 7 seater Gen 3 (DM) elec or self-levelling susp)	Front	
G8218 G8219	HYUNDAI	13-Sept 18	Santa Fe 4X4 5 & 7 seater Gen 3 (DM) elec or self-levelling susp)	Front	
G8218 G8219	KIA	12 – Feb'15	Sorento 4x2 gen 2 facelift (XM). elec or self-levelling susp	Front	
G8218 G8219	KIA	12 – Feb'15	Sorento 4x4 gen 2 facelift (XM). elec or self-levelling susp	Front	
G8221 G8222	PEUGEOT	Oct '12-19	208 1.0, 1.2T, 1.4, 1.6 Type 1, 2 & 3 susp (check front strut lower outer diamer OD = 47mm) gen 1 (A9)	Front	
G8223 G8224	PEUGEOT	Oct '12-19	208 1.4 Hdi, 1.6 GTi, 1.6 HDi Type 3 susp (check front strut lower outer diamer 51mm / Check brake hose bracket vs G8225 / 6) gen 1 (A9)	Front	
G8225 G8226	PEUGEOT	Oct '12-20	208 1.4 Hdi, 1.6 16v Turbo GTi, 1.6 Hdi Type 4 susp (check front strut lower outer diamer OD = 51mm / Check brake hose bracket vs G8223 / 4) gen 1 (A9)	Front	
G8230 G8231	TOYOTA	Nov'09-12	Corolla Verso MPV (AR20, AUR20, ZCR20)	Front	
G8237 G8238	NISSAN	11-19	Juke FWD (F15)	Front	
G8237 G8238	NISSAN	11-19	Juke AWD (F15)	Front	
G8260 G8261	TATA	12-on	Super Ace 1 ton drop side LCV 1.4	Front	
G8265 > G8266 >	TATA	Sept '08-16	Indica Vista Hatch gen 2 (V3) B-Line	Front	
G8274 G8275	MERCEDES-BENZ	12-Aug 18	A180, A200, A200d, A220d, A250 (W176) AMG & Sport susp	Front	
G8274 G8275	MERCEDES-BENZ	April '12-18	B180, B200, B200d, B220d, B250 (W246)	Front	
G8274 G8275	MERCEDES-BENZ	13-19	CLA200, CLA200d, CLA220d, CLA250 (C117) Sport susp, Incr ground clearance, AMG & Elec susp	Front	
G8282 G8283	FIAT	11-22	Panda 0.9, 1.2 AWD & 1.4 100HP) (319) mk4	Front	
G8288 G8289	FORD	15-17	B-Max Mini MPV 1.0 (JK)	Front	
G8288 G8289	FORD	Nov 12-17	Fiesta Sedan & Hatch Mk 6 facelift ST)	Front	
G8288 G8289	FORD	18-21	Figo Hatch & sedan gen 3	Front	
G8292 G8293	BMW	End 04-Oct '11	1 Series 116i,118i, 120i, 130i & 120d Sport Susp, xDrive & 135i Coupe)	Front	
G8292 G8293	BMW	End 04-Oct '11	1 Series 116i,118i, 120i, 130i, 135i & 120d Sport Susp std 135i Coupe xDrive)	Front	
G8292 G8293	BMW	March '05-12	3 series (E90 & E91) 320i, 320d, 323i, 325i, 330d, 330i & 335i Sport susp, M3, Cabrio & Coupe)	Front	
G8292 G8293	BMW	March '05-12	3 series Sport susp, (E90 & E91) 320i, 320d, 323i, 325i, 330d, 330i & 335i M3, Cabrio & Coupe)	Front	
G8292 G8293	BMW	07-12	330i, 335i Cabriolet M3, Coupe) (E93)	Front	

Key

	See important installation information on inside front cover
	Excluding self-levelling suspension
	Special order – phone 010 900 1850. 6-12 week waiting period

	Imported
	Internal bump stop
	Steering damper

- It is recommended that all new shock absorbers are fitted in pairs
- Do not mix gas and non-gas units on the same axle
- **Bold** part numbers indicate heavy-duty shocks
- Underlined part numbers indicate parts not immediately available
- *Italic* part numbers followed by > indicate parts to be discontinued

Passenger and light commercial

Part number [numerical listing]

Part number	Make	Year	Application	Position	Mounting information
G8292  G8293 	BMW	07 - 12	 320i, 325i, 335i Coupe ( M3, Cabrio) (E92)	Front	
G8294  G8295 	BMW	April '01- Feb'05	330i & 330d (E46)  325ti compact ( M3, cabrio, coupe,sport susp & S/W)	Front	
G8294  G8295 	BMW	98-05	E46 - Sport Pack II for BMW OE Sport Susp  Ci	Front	
G8294  G8295 	BMW	Nov'01-05	325ti Compact (E46)  Sport susp	Front	
G8294  G8295 	BMW	Oct '01-06	 325Ci, 330 Ci Coupe ( Sport Pac II & M3) (E46)	Front	
G8294  G8295 	BMW	00-06	 325Ci, 330 Ci Coupe Sport Pac II ( M3) (E46)	Front	
G8311	PEUGEOT	14-21	 308 1.2T gen 2 (T9)	Front	
G8312  G8313 	ALFA ROMEO	10-20	Giulietta (940) All	Front	
G8314  G8315 	FORD	13-on	EcoSport cross-over SUV 1.0T, 1.5, 1.5TDCi (Gen 2)	Front	
G8325	FIAT	03-10	Multipla MPV 1.6, 1.9JTD ( Bi-power)	Front	
G8340  G8341 	MAHINDRA	11-18	XUV 500 SUV 2.2	Front	
G8353  G8354 	CITROEN	13-17	C4 Aircross SUV 2.0, 1.6HDi 4x2 & 4x4	Front	
G8353  G8354 	MITSUBISHI	11-23	ASX SUV gen 1 (GA, W)	Front	
G8353  G8354 	MITSUBISHI	end'12-April 23	Outlander 2.4 SUV (Gen 3 GF/GG/ZJ/ZK) [Facelift in 2015]	Front	
G8353  G8354 	PEUGEOT	12-16	4008 SUV	Front	
G8377	RENAULT	end 09-16	Scenic III MPV 1.6, 1.9dCi	Front	
G8377	RENAULT	end 09-16	Grand Scenic III (LWB) 1.9dCi	Front	
G8379  G8380 	CITROEN	Nov'10-16	C4 (Gen 2) 1.6i, 2.0, 2.0 HDi ( DS4 & sport susp)	Front	
G8381  G8382 	FIAT	14-18	500L 1.4, 1.6 (5 door)  Std 500 models, "X" models, Abarth / sport susp (351 & 352)	Front	
G8383  G8384 	CITROEN	11-16	DS4 1.6, 2.0	Front	
G8383  G8384 	PEUGEOT	09-17	3008 MPV Crossover 1.6, 1.6 T, 2.0 Hdi gen 1 ( self leveling susp) (T8 / OU)	Front	
G8403	MERCEDES-BENZ	06-June'10	Viano 7 seater MPV 2.2 Cdi, 3.0 Cdi, 3.5V6  air susp (W639 gen 2)	Front	
G8403	MERCEDES-BENZ	04-Aug '10	Vito Minibus & Van 109CDi, 111CDi, 115CDi, 119, 120CDi, 122, 123, 126 (3.5) RWD  air susp (W639 Gen 2)	Front	
G8406  G8407 	KIA	Nov'09 - '11	Sorento 4x4 & 4x2 gen 2 (XM).  elec or self-levelling susp	Front	
G8406  G8407 	HYUNDAI	09-12	Santa Fe 4x2 & 4x4 Gen 2 (CM)  elec or self-levelling susp) (Smaller spring pan)	Front	
G8419  G8420 	VOLVO	12-19	V40 Hatch  T series	Front	
G8421  G8422 	VOLVO	10-18	S60 Sedan, gen 2  elec susp	Front	
G8421  G8422 	VOLVO	11-18	V60 S/Wagon  Cross Country  elec susp	Front	
G8425  G8426 	VOLVO	12-19	V40 Cross Country  T5	Front	
G8427  G8428 	BMW	96-'03	520i, 523i, 525i, 528i, 530d & 530i (E39) ( 535i, 540i, Sport susp, M5, Air Susp, M Tech, Elec susp & S/W)	Front	
G8427  G8428 	BMW	97-'03	5 Series Touring S/W ( 540i and Sport susp)	Front	
G8429	MERCEDES-BENZ	Sept'00-April '07	C180, C180K, C200, C200K, C220Cdi, C230, C230K, C240, C280, C320Cdi, C350 & C270CDI (W203)  S/Wagon (C203) ( AMG, Coupe & Sports susp)	Front	
G8429	MERCEDES-BENZ	April '02-09	 CLK320, CLK350 & CLK500 Coupe (C209) ( Sport & AMG)	Front	
G8429	MERCEDES-BENZ	02 - 09	 CLK320, CLK350 & CLK500 Cabriolet (A209) ( Sport & AMG)	Front	
G8611A  G8612A 	PEUGEOT	02-5/07	206 Cabrio cc	Front	

Key

*	See important installation information on inside front cover
!	Excluding self-levelling suspension
...	Special order - phone 010 900 1850. 6-12 week waiting period

~	Imported
#	Internal bump stop
⊕	Steering damper

- It is recommended that all new shock absorbers are fitted in pairs
- Do not mix gas and non-gas units on the same axle
- **Bold** part numbers indicate heavy-duty shocks
- Underlined part numbers indicate parts not immediately available
- *Italic* part numbers followed by > indicate parts to be discontinued

Passenger and light commercial

Part number [numerical listing]

Part number	Make	Year	Application	Position	Mounting information
G8613 R G8614 L	BMW	99 – Sept'01	320i, 323i, 325i & 328i (E46) (304) M3, cabrio, coupe & sport susp	Front	
G8613 R G8614 L	BMW	99- April '01	330i & 330d (E46) (304) M3, cabrio, coupe & sport	Front	
G8613 R G8614 L	BMW	00-05	320i, 325i Touring (E46) (304) Sport susp	Front	
G8613 R G8614 L	BMW	00-06	330Ci Cabriolet (304) Sport Pac II & M3) (E46)	Front	
G8613 R G8614 L	BMW	99 – Sept'01	318i & 320d (E46) (304) M3, cabrio, coupe, & sport susp	Front	
G8613 R G8614 L	BMW	Sept'01- Feb'05	318i (E46) (304) Compact, M3, cabrio, coupe, sport susp & S/W	Front	
G8613 R G8614 L	BMW	Sept'01- Feb'05	320i, 320d, 325i (E46) (304) Compact, M3, cabrio, coupe & sport susp	Front	
G8613 R G8614 L	BMW	Nov'01-05	318ti Compact (E46) (304) Sport susp	Front	
G8613 R G8614 L	BMW	00- 05	318i Touring (E46) (304) Sport susp	Front	
G8613 R G8614 L	BMW	99-Sept'01	325Ci, 330Ci Coupe (304) Sport Pac II & M3) (E46)	Front	
G8615 R G8616 L	BMW	91-92	320i, 325i & 325td Imported (304) M. Tech. (E36)	Front	
G8621 R G8622 L	OPEL	June 16-21	Astra (304) OPC, Coupe, Sports or Elec susp) B16 (K)	Front	
G8623 R G8624 L	FIAT	16-on	Tipo 1.4 & 1.6 (356)	Front	
G8626 R G8627 L	SUZUKI	April '14-17	SX4 1.6 4x2 & 4x4 S-Cross SUV (JY)	Front	
G8626 R G8627 L	SUZUKI	15-on	Vitara 4x4 1.4T, 1.6 gen 4 (LY)	Front	
G8629 R G8630 L	MAZDA	15-on	CX-3 SUV 2,0 (DK)	Front	
G8631 R G8632 L	FORD	17-22	Fiesta Sedan & Hatch Mk 7 HJ, HF	Front	
G8640 R G8641 L	BMW	April '14-17	2 Series Active Tourer MPV 218i, 220i, 225i, 220d (304) MTech & Sport Susp	Front	
G8640 R G8641 L	BMW	Nov 15-Oct 22	X1 (F48) sDrive FWD & xDrive AWD 1.8i, 2.0i, 2.0d (304) LWB F49	Front	
G8640 R G8641 L	BMW	Nov 18-on	X2 (F39) 1.8i, 2.0i sDrive FWD & 2.0d xDrive AWD	Front	
G8640 R G8641 L	MINI	15-24	Mini Clubman S/Wagon (304) sport (F54) mkII	Front	
G8640 R G8641 L	MINI	April 17-on	Mini Countryman SUV Crossover (304) AWD (F60) mkII	Front	
G8642 R G8643 L	MINI	14-24	Mini One, Cooper (F56 – 3 door, F55 – 5 door Mk III) (304) cabriolet (F57) & sport (304) JCW GP sport	Front	
G8649 R G8650 L	CITROEN	16-on	C3 III (SX, SY) (lower strut outer diameter is 51mm)	Front	
G8649 R G8650 L	CITROEN	19-on	C3 Aircross SUV 1,2, 1,6 (2R, 2C)	Front	
G8649 R G8650 L	OPEL	17-on	Crossland & Crossland X 1,2T SUV (P17)	Front	
G8651 R G8652 L	MINI	11-16	Mini Countryman SUV Crossover (304) AWD (R60) mkl	Front	
G8651 R G8652 L	MINI	13-16	Mini Paceman 2 door crossover (R61)	Front	
G8653	OPEL	18-on	Combo Cargo Panel Van & Life minibus 1,6TD (E)	Front	
G8653	PEUGEOT	19-on	Partner panel van 1.2T, 1.5Hdi, 1.6Hdi gen 3, 1000kg payload (K9)	Front	
G8801 R G8802 L	FORD	Nov'04-July'11	Focus 1.6, 1.6Si, 1.8TDCi, 2.0, 2.0Si, 2.0TDCi & TDCi Si, (304) 2.5 ST front only, Hatch and Sedan MkII DA, DP (304) 2.5 ST rear & RS)	Front	
G8803 R G8804 L	MAZDA	04-09	Mazda 3 gen 1 (BK) (304) MPS, sport susp or AWD	Front	
G8803 R G8804 L	MAZDA	Mid 09-Sept'14	Mazda 3 gen 2 (BL) (304) MPS, sport susp or AWD	Front	
G8807 R G8808 L	FORD	13-'19	Kuga 4x2 & 4x4 SUV (gen 2) DM2, C520	Front	

Key



*	See important installation information on inside front cover
!	Excluding self-leveling suspension
"..."	Special order – phone 010 900 1850. 6-12 week waiting period

~	Imported
#	Internal bump stop
⊕	Steering damper

- It is recommended that all new shock absorbers are fitted in pairs
- Do not mix gas and non-gas units on the same axle
- **Bold** part numbers indicate heavy-duty shocks
- Underlined part numbers indicate parts not immediately available
- *Italic* part numbers followed by > indicate parts to be discontinued

Passenger and light commercial

Part number [numerical listing]

Part number	Make	Year	Application	Position	Mounting information
G8809  G8810 	FORD	13-19	Kuga 4x2 & 4x4 SUV (gen 2) DM2, C520	Front	
G8811  G8812 	VOLVO	07-13	C30 Hatch	Front	
G8811  G8812 	VOLVO	06-14	 C70 Cabriolet	Front	
G8811  G8812 	VOLVO	June '04-Oct '12	S40 Sedan & V50 S/W  T5 (Gen 2)	Front	
G8813  G8814 	TOYOTA	17-23	C-HR 1.2T Cross-over Coupe (AX10)	Front	
G8819	MERCEDES-BENZ	Oct '15 - on	V Class 7 seater MPV minibus RWD V200d, V220d, V250d, V300d (W447 Gen 3)  FWD & AWD	Front	
G8820	MERCEDES-BENZ	Oct '15 - on	Vito Van 111 1.6 FWD (W447 Gen 3)  RWD & AWD	Front	
G9028  G9029 	DATSUN	2015-22	Go hatch  Go+ (7 seater)	Front	
G9076	RENAULT	16-on	Kwid 1.0 SUV (BW)	Front	
G9505 >	DAIHATSU	March '05-10	Sirion 1.3 & 1.5 hatch 4x2,  4x4 (M300) - Cross border = Boon	Front	
G9505 >	DAIHATSU	11- early '16	Sirion 1.3 & 1.5 hatch gen 2 4x2,  4x4 (M600) - Cross border = Boon	Front	
G9513  G9514 	SUZUKI	15-22	Celerio hatch 1.0 gen 2 (FE)	Front	
GA2009 >	CHEVROLET	72-78	LUV	Front	 
GA2009 >	ISUZU	78-Mid 81	KB10, KA20, KA25	Front	 
GA2009 >	ISUZU	Mid 81-89	KB41, KB43, KBD42 4x4	Front	 
GA2054 >	GOLF CARTS	Various	Golf carts (S S Stud OD's 10mm / Comp 185mm / Ext 265mm)	Rear	 
GA2056 >	CHEVROLET	75-78	(S/W) 2500 & 3800 S/Wagon	Rear	 
GA2056 >	CHEVROLET	78-89	(S/W) Rekord & Commodore S/Wagon	Rear	 
GA2056 >	OPEL	68-73	 Rekord All 6 Cylinder	Rear	 
GA2056 >	OPEL	78-91	(S/W) Rekord & Commodore S/Wagon	Rear	 
GA2056 >	TOYOTA	78-81	Cressida S/Wagon	Rear	 
GA2057 >	RANGER	68-73	(S/W) S/Wagon All	Rear	 
GA2057 >	TOYOTA	74-Mid 80	 Corolla (Imported Strut) (KE)	Rear	 
GA2057 >	TOYOTA	64-74	Corona (MKI)	Rear	 
GA2057 >	TOYOTA	72-78	2000 (MKII)	Rear	 
GA2058 >	VOLKSWAGEN	68-80	Kombi, Panelvan & Microbus ( Fleetline)	Front	 
GA2058 >	VOLKSWAGEN	62-69	1500, 1600 Sedan, Variant & Fastback ( Automatics)	Front	 
GA2059 >	VOLKSWAGEN	68-80	Kombi, Panelvan & Microbus ( Fleetline)	Rear	 
GA2068 >	CHEVROLET	68-72	El Camino	Rear	 
GA2076 >	FORD	Mid 78-Mid 83	Cortina LDV All (MKIV)	Rear	 
GA2077 >	MAZDA	77-78	323 (Imported Strut) R.W.D (FA 4th gen)	Rear	 
GA2077 >	MAZDA	78-Mid 81	323 (Local Strut) R.W.D (FA 4th gen)	Rear	 
GA2078 >	FORD	Mid 80-83	 Cortina Sedan (MKV)	Rear	 
GA2080 >	FORD	Mid 83-86	Cortina One Tonner LDV (MKV)	Rear	 
GT0102	AUDI	75-Mid 81	80 Sedan & S/Wagon	Front	
GT0102	VOLKSWAGEN	81-87	  Passat Sedan & S/Wagon (B2)	Front	
GT0104	TOYOTA	74-Mid 80	 Corolla (Imported Strut) (KE)	Front	
GT0104	TOYOTA	Mid 80-85	 Corolla Sedan R.W.D.(Local Strut) (KE70, AE70)	Front	
GT0104	TOYOTA	82-88	  Corolla S/Wagon & Panelvan R.W.D (KE71, KE72, KE73)	Front	
GT0104	TOYOTA	79-88	Corolla Van	Front	

Key

*	See important installation information on inside front cover
!	Excluding self-levelling suspension
"..."	Special order - phone 010 900 1850. 6-12 week waiting period

~	Imported
#	Internal bump stop
⊕	Steering damper

- It is recommended that all new shock absorbers are fitted in pairs
- Do not mix gas and non-gas units on the same axle
- **Bold** part numbers indicate heavy-duty shocks
- Underlined part numbers indicate parts not immediately available
- *Italic* part numbers followed by > indicate parts to be discontinued

Passenger and light commercial

Part number [numerical listing]

Part number	Make	Year	Application	Position	Mounting information
GT0114	NISSAN	Mid 87-92	 Skyline All (incl New Era)	Front	
GT0115	TOYOTA	86-92	Cressida Sedan (excl I.R.S.)	Front	
GT0115	TOYOTA	86-92	Cressida 2,8 & 3,0 (& All I.R.S.)	Front	
GT0115	TOYOTA	86-92	Cressida S/Wagon	Front	
GT0116	CHEVROLET	78-92	 Rekord & Commodore Sedan	Front	
GT0116	CHEVROLET	78-89	(S/W) Rekord & Commodore S/Wagon	Front	
GT0116	CHEVROLET	79-82	Senator	Front	
GT0116	OPEL	78-91	 Rekord & Commodore Sedan	Front	
GT0116	OPEL	78-91	(S/W) Rekord & Commodore S/Wagon	Front	
GT0116	OPEL	91-95	 Rekord 4 Cylinder (Solid Axle)	Front	
GT0116	OPEL	91-95	 Rekord 6 Cylinder (I.R.S.)	Front	
GT0116	OPEL	79-86	Senator	Front	
GT0117	DAEWOO	95-98	Cielo	Front	
GT0117	DAEWOO	96-98	Espero	Front	
GT0117	DAEWOO	98-03	Lanos T100	Front	
GT0117	OPEL	80-Mid 85	 Kadett FWD (D)	Front	
GT0117	OPEL	80-Mid 85	(S/W) Kadett S/Wagon FWD (D)	Front	
GT0117	OPEL	Mid 85-88	  Kadett & Monza Sedan "T car" (E) (incl Gsi & Cabriolet)	Front	
GT0117	OPEL	89-92	  Kadett & Monza Sedan (incl Cub & Gsi 2.0) (F.W.D) "T car" (E)	Front	
GT0118	BMW	Mid 85-89	518, 520, 525, 525e, 528 & 535e (E28) (excl M Tech)	Front	
GT0118	BMW	6/82 - '90	628CSi, 635CSi (E24) (excl elec suspension)	Front	
GT0119	OPEL	93- Oct '99	  Kadett & Astra (incl S/W) (F)	Front	
GT0120	TOYOTA	Mid '81-Mid '86	Cressida Sedan (excl 2,8 I.R.S.)	Front	
GT0120	TOYOTA	84-85	Cressida 2,8 GLI 6 (I.R.S.)	Front	
GT0120	TOYOTA	Mid '81-85	Cressida S/Wagon	Front	
GT0401	DATSUN	71-75	 1200 Sedan (incl GX Sedan)	Front	
GT0401	DATSUN	72-75	 1200 GX Coupe	Front	
GT0401	DATSUN	75-80	 120Y & 140 SDX Sedan - 12" Wheels (excl 160 & 13" Wheels)	Front	
GT0401	DATSUN	71-79	B120 LDV, 120Y LDV	Front	
GT0401	DATSUN	76-83	120Y Panel Van (12" wheels)	Front	
GT0401	DATSUN	80-08	B140 1400 LDV & Panel Van	Front	
GT0402	MAZDA	78-Mid 81	323 (Local Strut) R.W.D (FA 4th gen)	Front	
GT0702	BMW	84-91	 318i, 320i, 323i & 325i (E30) (excl iS & cabrio (51mm strut OD)	Front	
GT0702	BMW	87-91	  325iS Evo I & II std and E30 Cabriolet (51mm strut OD)	Front	
GT1001	AUDI	95- Jan '99	 A4 Sedan (excl Quattro, Sport) 8D, B5	Rear	 
GT1002	AUDI	98-April '03	A3 1.8 & 1.8T turbo, 1.9TDi (excl Sport Susp, Quattro & S3)	Rear	 
GT1002	VOLKSWAGEN	99-Oct '12	New Beetle (Type 2)	Rear	 
GT1002	VOLKSWAGEN	99-04	Golf IV & Jetta IV 1.6 only (excl Estate S/W) 20mm rod	Rear	 
GT1002	VOLKSWAGEN	99-04	Golf IV & Jetta IV 1.8, Gti Turbo, 1.9 Tdi, 2.0, 2.3 V5 (excl Estate S/W & 1.6) 22mm rod	Rear	 
GT1003	SEAT	06-08	Ibiza Hatch & Sedan (excl sport susp)	Rear	 
GT1003	VOLKSWAGEN	Oct '02-Jan '10	Polo Hatch & Classic Sedan (excl GTi & Sport susp, CrossPolo (mk 4 9N3)	Rear	 
GT1003	VOLKSWAGEN	Feb '10-Jan '18	 Polo Hatch, (excl GTi & Sport susp, Vivo, Sedan & Cross (mk 5 model, 6R, 6C)	Rear	 

Key

*	See important installation information on inside front cover
!	Excluding self-levelling suspension
"..."	Special order - phone 010 900 1850. 6-12 week waiting period

~	Imported
#	Internal bump stop
⊕	Steering damper

- It is recommended that all new shock absorbers are fitted in pairs
- Do not mix gas and non-gas units on the same axle
- **Bold** part numbers indicate heavy-duty shocks
- Underlined part numbers indicate parts not immediately available
- *Italic* part numbers followed by > indicate parts to be discontinued

Passenger and light commercial

Part number [numerical listing]

Part number	Make	Year	Application	Position	Mounting information
GT1003	VOLKSWAGEN	March 18-on	Polo VIVO (mk 5 model, 6R, 6C) 301 Maxx, GT & Sport susp	Rear	⊥ ⊕
GT1003	VOLKSWAGEN	Feb '10-Feb '18	Polo VIVO (mk 4 9N3) 301 Maxx, GT & Sport susp	Rear	⊥ ⊕
GT1004	FORD	Mid 99 -03	Fiesta EXC1 RSi) Mk4 facelift (JA, JB)	Rear	⊥ ⊕
GT1004	FORD	00-06	Ikon sedan All	Rear	⊥ ⊕
GT1004	MAZDA	99 - 06	121 Soho gen 4 facelift (BE, JA, JB)	Rear	⊥ ⊕
GT1006	AUDI	Dec '00- 04	+ A4 Sedan & Avant + Quattro EXC1 Sport Susp, S4, & RS4) B6. 8E	Rear	⊥ ⊕
GT1006	AUDI	05-07	(S/W) A4 EXC1 Quattro, Avant & Allroad 301 Sport susp, S4 & RS4) B7	Rear	⊥ ⊕
GT1011	VOLKSWAGEN	78-92	Golf I / Jetta I & Citi EXC1 Fox, CTi, ShuttleTrippa & Cabriolet	Rear	⊗ ⊕
GT1011	VOLKSWAGEN	93-10	CITI - 301 Sonic, Life, VeloCITI & Rox (Sealed Strut)	Rear	⊗ ⊕
GT1012	VOLKSWAGEN	85-93	Golf II & Jetta II	Rear	⊗ ⊕
GT1012	VOLKSWAGEN	92-94	Golf III & Jetta III 301 VR6)	Rear	⊗ ⊕
GT1012	VOLKSWAGEN	95-99	Golf III & Jetta III EXC1 Gti & Cli 301 VR6)	Rear	⊗ ⊕
GT1012	VOLKSWAGEN	93-'04	Golf III & IV Cabriolet 301 16" wheels)	Rear	⊗ ⊕
GT1013	TOYOTA	Nov'02-Sept'07	Corolla Sedan & RunX Hatch 301 Verso MPV, TRD) gen 9 (E120 & E121)	Rear	⊥ ⊕
GT1013	TOYOTA	Nov'02-Sept'07	"Bubble" Corolla Sedan & Hatch Cross border export mkt 301 Verso MPV, TRD) 1NZ	Rear	⊥ ⊕
GT1013	TOYOTA	06-12	(S/W) Corolla Axio & Fielder S/W (E140 narrow body jap model) Cross border export mkt	Rear	⊥ ⊕
GT1014	AUSTIN	59-84	Mini EXC1 Cooper (MKIII)	Rear	⊥ ⊕
GT1015	AUSTIN	59-84	Mini EXC1 Cooper (MKIII)	Front	⊕ ⊕
GT1015	AUSTIN	59-84	Mini	Front	⊕ ⊕
GT1015	GOLF CARTS	Various	Golf carts (Check lengths and mounting type & dimensions)	Front	⊕ ⊕
GT1015	GOLF CARTS	Various	Golf carts (ES ES ID 10mm / Comp 222mm / Ext 310mm)	Rear	⊕ ⊕
GT1016	VOLKSWAGEN	98-Sept'02	Polo Playa Hatch & Classic Sedan (mk 3 6N) 301 sport susp	Rear	⊗ ⊕
<i>GT1017 ></i>	FORD	95- 99	Escort	Rear	⊥ ⊕
GT1018	FORD	97- Mid 99	Fiesta EXC1 Power steering) Mk4 (JA, JB)	Rear	⊥ ⊗
GT1018	MAZDA	97- 99	121 Soho gen 4 (BE, JA, JB)	Rear	⊥ ⊗
GT1021	OPEL	96-Late 04	Corsa LDV	Rear	⊕ ⊕
GT1024	OPEL	82-86	Ascona	Rear	⊥ ⊕
GT1024	OPEL	80-Mid 85	Kadett FWD (D)	Rear	⊥ ⊕
GT1024	OPEL	Mid 85-88	Kadett & Monza Sedan "T car" (E) EXC1 Gsi & Cabriolet	Rear	⊥ ⊕
GT1025	DAEWOO	95- 98	Cielo	Rear	⊥ ⊕
GT1025	DAEWOO	96- 98	Espero	Rear	⊥ ⊕
GT1025	DAEWOO	98-'03	Lanos T100	Rear	⊥ ⊕
GT1025 *7	OPEL	89-92	Kadett & Monza Sedan EXC1 Cub & Gsi 2.0) (F.W.D) "T car" (E)	Rear	⊥ ⊕
GT1026	FIAT	90-'09	Uno EXC1 raised body "Way" version from Brazil)	Rear	⊥ ⊕
GT1026	GOLF CARTS	Various	Golf carts (S ES 10mm OD stud & 10mm ID eye / Comp 302mm / Ext 498mm)	Rear	⊥ ⊕
GT1027	OPEL	93- Oct '99	Kadett & Astra 301 S/W) (F)	Rear	⊥ ⊕
GT1028	OPEL	80-Mid 85	(S/W) Kadett S/Wagon FWD (D)	Rear	⊕ ⊥
GT1028	OPEL	93- Oct '99	(S/W) Astra Estate S/Wagon (F)	Rear	⊕ ⊥
GT1029	OPEL	96-02	Corsa Hatch & Notch (sedan) EXC1 Corsa LITE & Lite Sport (B)	Rear	⊥ ⊕
GT1029	OPEL	02-15	Corsa LITE & Lite Sport - old shape Corsa hatch (B)	Rear	⊥ ⊕
GT1029	OPEL	End 02-Oct '07	Corsa Hatch & Classic (sedan) 301 Lite) (C)	Rear	⊥ ⊕
GT1029	OPEL	98-02	Corsa Pronto Panel Van	Rear	⊥ ⊕

Key





*	See important installation information on inside front cover
!	Excluding self-levelling suspension
"..."	Special order - phone 010 900 1850. 6-12 week waiting period

~	Imported
#	Internal bump stop
⊕	Steering damper

- It is recommended that all new shock absorbers are fitted in pairs
- Do not mix gas and non-gas units on the same axle
- **Bold** part numbers indicate heavy-duty shocks
- Underlined part numbers indicate parts not immediately available
- *Italic* part numbers followed by > indicate parts to be discontinued

Passenger and light commercial

Part number [numerical listing]

Part number	Make	Year	Application	Position	Mounting information
GT1030	OPEL	Nov'99-Sept'04	 Astra hatch & Classic sedan (G) 301 OPC & S/W	Rear	⊖ ⊖
<i>GT1031</i> >	ALFA ROMEO	91- 97	155 301 2500 V6, 2.5TD, 2.0 Turbo AWD, elec susp	Rear	⊖ ⊖
<i>GT1031</i> >	ALFA ROMEO	91- 97	155 2500 V6, 2.5TD 301 elec susp	Rear	⊖ ⊖
<i>GT1031</i> >	FIAT	00-10	Palio Weekend S/Wagon Type PY & 1Y + gen 2 Type ZG & 2K 1.4	Rear	⊖ ⊖
<i>GT1035</i> > GT1036	NISSAN	01 – May'06	 Almera Sedan 301 Hatch (N16) 301 ABS	Rear	⊥ ⊖
GT1059	VOLKSWAGEN	98-10	Citi – Sonic, Life & VeloCiti Slight OE lowering 301 Rox – shorter rear	Rear	⊗ ⊖
GT1069	DAIHATSU	June'06 – 17	Terios 4x2 & 4x4 (J200 SWB 5 seater & J700 LWB 7 seater) Generation Two	Rear	○ ○
GT1069	TOYOTA	06-11	Avanza 1.3, 1.5 MPV & Panel Van 301 & 301 ABS (F600) Gen 1 301 facelift	Rear	⊖ ⊖
GT1072	NISSAN	07-13	Livina MPV 7 seater 301 X-Gear & Grand Livina (X11J)	Rear	⊥ ○
GT1072	NISSAN	Aug '06 -13	Tiida 1.6 & 1.8 Hatch / Sedan gen 1 (X11C)	Rear	⊥ ○
GT1231	VOLKSWAGEN	Feb'10-19	 Polo Sedan, 301 Vivo, Gti, hatch – V, Shock body length 396mm (mk 5 model, 6V2)	Rear	⊥ ⊖
GT1231	VOLKSWAGEN	10/02-1/10	CrossPolo & Vivo Maxx 301 Sport Susp (mk 4 9N3) OE# = 6R0512011BT body length 396mm	Rear	⊥ ⊖
GT1231	VOLKSWAGEN	11-18	CrossPolo & Vivo Maxx 301 Sport Susp (mk 5 6R) OE# = 6R0512011BT body length 396mm	Rear	⊥ ⊖
GT1376	AUDI	June 18 – on	A1 Sportback Gen 2 (GB) 30TFSI (1.0), 35TFSI (1.5), 40TFSI (2.0) 301 Sport susp	Rear	⊥ ⊖
GT1376	VOLKSWAGEN	Feb '18 – on	 Polo Hatch, 301 Vivo, Sedan & Cross (mk 6, model AW)	Rear	⊥ ⊖
GT1376	VOLKSWAGEN	19-on	T-Cross SUV (C11)	Rear	⊥ ⊖
GT2001	FORD	94-Nov'02	Bantam LDV	Rear	⊖ ⊖
GT2001	FORD	Dec '02-11	Bantam LDV	Rear	⊖ ⊖
GT2001	MAZDA	94-10	Rustler LDV	Rear	⊖ ⊖
GT2006	DATSUN	75-80	(S/W) 140Y & 160Y S/Wagon	Rear	○ ○
GT2006	DATSUN	71-79	B120 LDV, 120Y LDV	Rear	○ ○
GT2006	DATSUN	76-83	120Y Panel Van (12" wheels)	Rear	○ ○
GT2006	DATSUN	80-08	B140 1400 LDV & Panel Van	Rear	○ ○
GT2006	DATSUN	80-87	720 Series, 1800, 2200 LDV	Rear	○ ○
GT2006	FORD	85-98	Husky Minibus, LDV, Panelvan	Rear	○ ○
GT2006	HILLMAN	67-76	Hunter, Minx & Vogue Estate 301 sedan)	Rear	○ ○
GT2006	MITSUBISHI	82-04	L300 Van & Minibus 301 LDV)	Rear	○ ○
GT2006	TOYOTA	87- 01	Stallion LDV & Van	Rear	○ ○
GT2006	TOYOTA	91- mid 00	Venture Wagon 301 "Getaway"	Rear	○ ○
GT2007 >	FORD	69-76	 Old Fairlane & Fairmont	Rear	⊥ T
GT2007 >	FORD	69-76	Old Ranchero	Rear	⊥ T
GT2007 >	MAZDA	69-74	1200 & 1300 Sedan	Rear	⊥ T
<i>GT2007</i> >	MAZDA	68-85	B1500, B1600, B1800 LDV	Rear	⊥ T
GT2007 >	MAZDA	64-83	E2000 & E3000 LDV	Rear	⊥ T
GT2007 >	MAZDA	68-81	F1000 & F1300 LDV	Rear	⊥ T
GT2008	TOYOTA	Mid 00- 05	Condor 4x4	Rear	○ ○
GT2008	TOYOTA	69-73	RT 6Z 1900 (MKII)	Rear	○ ○
GT2008	TOYOTA	64-73	Corona MKI & MKII LDV	Rear	○ ○
GT2008	TOYOTA	69-83	Hi-Ace SWB Minibus (H20, H30, H40)	Rear	○ ○
GT2008	TOYOTA	69-83	Hi-Ace SWB Panelvan	Rear	○ ○
GT2008	TOYOTA	69-83	Hilux 4x2 N10, N20, N30, N40)	Rear	○ ○
GT2008	TOYOTA	82-87	TUV LDV	Rear	○ ○

Key

*	See important installation information on inside front cover
!	Excluding self-leveling suspension
"..."	Special order – phone 010 900 1850. 6-12 week waiting period

~	Imported
#	Internal bump stop
⊖	Steering damper

- It is recommended that all new shock absorbers are fitted in pairs
- Do not mix gas and non-gas units on the same axle
- **Bold** part numbers indicate heavy-duty shocks
- Underlined part numbers indicate parts not immediately available
- *Italic* part numbers followed by > indicate parts to be discontinued

Passenger and light commercial

Part number [numerical listing]

Part number	Make	Year	Application	Position	Mounting information
GT2008	WILLYS	66-79	CJ5, CJ6 & CJ7 Jeep	Rear	○ ○
GT2009	CHEVROLET	72-78	LUV	Front	⊥ ⊕
GT2009	ISUZU	78-Mid 81	KB10, KA20, KA25	Front	⊥ ⊕
GT2009	ISUZU	Mid 81-89	KB41, KB43, KBD42 4x4	Front	⊥ ⊕
GT2009	ISUZU	83-86	Trooper UBS 52 series	Front	⊥ ⊕
GT2010	TOYOTA	64-74	Corona (MKI)	Front	⊥ ⊕
GT2010	TOYOTA	74-80	Corona (MKI)	Front	⊥ ⊕
GT2010	TOYOTA	69-73	RT 62 1900 (MKII)	Front	⊥ ⊕
GT2010	TOYOTA	72-78	2000 (MKII)	Front	⊥ ⊕
GT2010	TOYOTA	64-73	Corona MKI & MKII LDV	Front	⊥ ⊕
GT2010	TOYOTA	69-83	Hilux 4x2 N10, N20, N30, N40)	Front	⊥ ⊕
GT2011	VOLKSWAGEN	62-69	1500, 1600 Sedan, Variant & Fastback 300 Automatics)	Rear	⊖ ⊖
GT2011	VOLKSWAGEN	52-79	Beetle (Type 1) All Built in RSA (100 Beach Buggy)	Rear	⊖ ⊖
GT2011	VOLKSWAGEN	65 - 03	Beetle (Type 1) Imported, 100 Mexico	Rear	⊖ ⊖
GT2011	VOLKSWAGEN	57-68	Kombi, Panelvan & Microbus	Rear	⊖ ⊖
GT2011	VOLKSWAGEN	75-79	Fleetline	Rear	⊖ ⊖
GT2015	TOYOTA	Mid 80-85	 Corolla Sedan R.W.D.(Local Strut) (KE70, AE70)	Rear	⊥ ○
GT2015	TOYOTA	74-80	Corona (MKI)	Rear	⊥ ○
GT2015	TOYOTA	78-81	Cressida Sedan	Rear	⊥ ○
GT2015	TOYOTA	Mid'81-Mid'86	Cressida Sedan (300 2,8 I.R.S.)	Rear	⊥ ○
GT2015	TOYOTA	86-92	Cressida Sedan (300 I.R.S.)	Rear	⊥ ○
GT2018	FORD	83-86	Bantam LDV	Rear	⊖ ⊖
GT2018	FORD	87-93	Bantam LDV	Rear	⊖ ⊖
GT2018	MAZDA	87-93	Rustler LDV	Rear	⊖ ⊖
GT2019	VOLKSWAGEN	80-'03	Kombi, Panelvan, Microbus, Caravelle & Transporter Type III (300 Syncro 4x4, & Front engined T4)	Rear	⊖ ⊖
GT2020	VOLKSWAGEN	81-09	Golf LDV 100 old Caddy and Citi Pick-Up	Rear	⊖ ⊖
GT2021	FOTON	10-16	Thunda 2.2, 2.8 pick up	Front	⊥ ⊕
GT2021	ISUZU	Mid 81-89	KB21, KB23, KB28, KBD22, KBD27 4X2	Front	⊥ ⊕
GT2022	TOYOTA	84-85	Cressida 2,8 GLL 6 (I.R.S.)	Rear	⊥ ○
GT2022	TOYOTA	86-92	Cressida 2,8 & 3,0 (& All I.R.S.)	Rear	⊥ ○
GT2023	BAW / CAM	07-15	Rhino LDV	Front	⊥ ⊕
GT2023	FORD	91-03	Spectron 16 Seater Minibus & Panelvan	Front	⊥ ⊕
GT2023	FOTON	10-16	Thunda 2.2, 2.8 pick up	Front	⊥ ⊕
GT2023	GWM	07-11	GWM pick-up 2.2, 2.8 Tdi 4x2	Front	⊥ ⊕
GT2023	KIA	98-01	Ceres dropside LDV gen 3	Front	⊥ ⊕
GT2023	KIA	01 - 04	Pregio 12 seater minibus	Front	⊥ ⊕
GT2023	MAZDA	91-03	Marathon 16 Seater Minibus & Panelvan	Front	⊥ ⊕
GT2023	TOYOTA	84-End'98	Hilux All 4x2 (N50, N60)	Front	⊥ ⊕
GT2023	GONOW	08-on	X-Space 2.2, 2.8 4x2 LDV	Front	⊥ ⊕
GT2023	KIA	01-04	K2700 LDV gen 3	Front	⊥ ⊕
GT2023	KIA	end 04-14	K2700 1.3 ton & K2500 1.0 ton LDV gen 4	Front	⊥ ⊕
GT2024	BAW / CAM	07-15	Rhino LDV	Rear	○ ○

Key

*	See important installation information on inside front cover
!	Excluding self-levelling suspension
"..."	Special order - phone 010 900 1850. 6-12 week waiting period

~	Imported
#	Internal bump stop
⊕	Steering damper

- It is recommended that all new shock absorbers are fitted in pairs
- Do not mix gas and non-gas units on the same axle
- **Bold** part numbers indicate heavy-duty shocks
- Underlined part numbers indicate parts not immediately available
- *Italic* part numbers followed by > indicate parts to be discontinued

Passenger and light commercial

Part number [numerical listing]

Part number	Make	Year	Application	Position	Mounting information
GT2024	DATSUN	71-78	240C, 260C, & 300C	Rear	○ ○
GT2024	FORD	91-03	Spectron 16 Seater Minibus & Panelvan	Rear	○ ○
GT2024	GONOW	08-on	X-Space 2.2, 2.8 4x2 LDV	Rear	○ ○
GT2024	GWM	07-11	GWM pick-up 2.2, 2.8 Tdi 4x2	Rear	○ ○
GT2024	ISUZU	Mid 81-89	KB21, KB23, KB28, KBD22, KBD27 4X2	Rear	○ ○
GT2024	ISUZU	89-June'04	KB 4x2 std height EXC raised body & KB320) TF Series	Rear	○ ○
GT2024	MAZDA	91-03	Marathon 16 Seater Minibus & Panelvan	Rear	○ ○
GT2024	TOYOTA	84-End'98	HiLux All 4x2 (N50, N60)	Rear	○ ○
GT2024	ISUZU	Mid 81-89	KB41, KB43, KBD42 4x4	Rear	○ ○
GT2024	ISUZU	89-June'04	KB 4x4 & Raised body 4x2 INC all KB320) TF Series	Rear	○ ○
GT2025	ISUZU	89-June'04	KB 4x2 std height EXC raised body & KB320) TF Series	Front	⊥ ⊕
GT2025	NISSAN	88- mid 99	1 Tonner 4x2 (AW) INC Hardbody,Hi Rider, Sani, D/Cab & Diesel (GD21)	Front	⊥ ⊕
GT2025	NISSAN	Mid 99-07	Hardbody 4x2 (QW) LDV EXC Hi-Rider) D22	Front	⊥ ⊕
GT2025	NISSAN	08-21	NP300 4x2 LDV EXC Hi-Rider) (D22)	Front	⊥ ⊕
GT2025	TOYOTA	84-93	Hi-Ace SWB Minibus (H50)	Front	⊥ ⊕
GT2025	TOYOTA	85-93	Hi-Ace LWB 16 Seater Minibus / Taxi (H50)	Front	⊥ ⊕
GT2025	TOYOTA	84-88	Hi-Ace SWB Panelvan	Front	⊥ ⊕
GT2025	TOYOTA	85-93	Hi-Ace LWB Panelvan	Front	⊥ ⊕
GT2027	BMW	84-91	 318i, 320i, 323i & 325i (E30) EXC iS & cabrio (51mm strut OD)	Rear	⊥ ⊕
GT2027	BMW	87-91	  325iS Evo I & II std and E30 Cabriolet (51mm strut OD)	Rear	⊥ ⊕
GT2028	TOYOTA	Mid 00- 05	Condor 4x2	Front	⊥ ⊕
GT2028	TOYOTA	87- 01	Stallion LDV & Van	Front	⊥ ⊕
GT2028	TOYOTA	91- mid 00	Venture Wagon INC "Getaway"	Front	⊥ ⊕
GT2030	MAZDA	86- 3/00	B Series Magnum All 4x2	Front	⊥ ⊕
GT2030	FORD	86-Jan'00	Courier All 4X2	Front	⊥ ⊕
GT2030	FORD	Feb'00-June'07	Ranger 4x2 EXC Hi-Trail)	Front	⊥ ⊕
GT2030	GWM	08-on	Steed 5 & 5E 4x2 & 4x4 LDV ("Wingle" series)	Front	⊥ ⊕
GT2030	JMC	10-16	Boarding Pick-up 4x2	Front	⊥ ⊕
GT2030	MAZDA	4/00-07	Drifter 4x2 std ht EXC Hi-Trail 4x2)	Front	⊥ ⊕
GT2030	MAZDA	07-11	BT-50 4x2 std ht EXC Hi-Trail 4x2) gen 1 (UN)	Front	⊥ ⊕
GT2030	FORD	July'07-11	Ranger 4x2 EXC Hi-Trail)	Front	⊥ ⊕
GT2030	JMC	10-16	Boarding Pick-up 4x4	Front	⊥ ⊕
GT2031	FORD	86-Jan'00	Courier All 4X2	Rear	○ ○
GT2031	FORD	Feb'00-June'07	Ranger 4x2 EXC Hi-Trail)	Rear	○ ○
GT2031	MAZDA	86- 3/00	B Series Magnum All 4x2	Rear	○ ○
GT2031	MAZDA	4/00-07	Drifter 4x2 std ht EXC Hi-Trail 4x2)	Rear	○ ○
GT2031	MINIBUS	End 98-09	L200 Colt LDV 4x2 standard height	Rear	○ ○
GT2031	MINIBUS	07-16	Triton LDV All 4x4 & 4x2 raised body Std height gen 4 (MN)	Rear	○ ○
GT2031	NISSAN	88- mid 99	1 Tonner 4x2 & 4x4 (AW) INC Hardbody,Hi Rider, Sani, D/Cab & Diesel (GD21)	Rear	○ ○
GT2031	NISSAN	Mid 99-07	Hardbody 4x2 (QW) LDV EXC Hi-Rider) D22	Rear	○ ○
GT2031	NISSAN	08-21	NP300 4x2 LDV EXC Hi-Rider) (D22)	Rear	○ ○
GT2031	NISSAN	88-00	Sani Wagon 4x2	Rear	○ ○

Key





*	See important installation information on inside front cover
!	Excluding self-levelling suspension
"..."	Special order - phone 010 900 1850. 6-12 week waiting period

~	Imported
#	Internal bump stop
⊕	Steering damper

- It is recommended that all new shock absorbers are fitted in pairs
- Do not mix gas and non-gas units on the same axle
- **Bold** part numbers indicate heavy-duty shocks
- Underlined part numbers indicate parts not immediately available
- *Italic* part numbers followed by > indicate parts to be discontinued

Passenger and light commercial

Part number [numerical listing]

Part number	Make	Year	Application	Position	Mounting information
GT2031	NISSAN	88-00	Sani Wagon 4x4	Rear	○ ○
GT2031	TOYOTA	Mid 00- 05	Condor 4x2	Rear	○ ○
GT2033	MITSUBISHI	95-End 98	L200 Colt 4X2	Front	⊥ ⊕
GT2033	MITSUBISHI	End 98-09	L200 Colt LDV 4x2 standard height	Front	⊥ ⊕
GT2033	MITSUBISHI	End 98-08	L200 Colt LDV 4x4  Rodeo & Pioneer 4x2 raised height & Clubcab	Front	⊥ ⊕
GT2034	MITSUBISHI	95-End 98	L200 Colt 4X2	Rear	○ ○
GT2035	TOYOTA	End 98-May'05	Hilux P690 4x2 IFS  raised body gen 6 (N140, N150, N160, N170)	Front	⊥ ⊕
GT2036	TOYOTA	End 98-May'05	Hilux P690 4x2 IFS  raised body gen 6 (N140, N150, N160, N170)	Rear	○ ○
GT2043	BMW	91-99	316i, 318i, 318is, 318tds, 320i, 323i, 325i, 325td, 325tds, 328i Imported & Local Strut.  Cabrio.  M. Tech. (E36)	Rear	⊗ ⊕
GT2043	BMW	91-92	320i, 325i & 325td Imported  M. Tech. (E36)	Rear	⊗ ⊕
GT2043	BMW	93-99	 323i, 325i & 328i Cabriolet ( M Tech) (E36)	Rear	⊗ ⊕
GT2044	JMC	10-16	Boarding Pick-up 4x2 & 4x4	Rear	⊕ ⊕
GT2044	KIA	98-04	Ceres dropside LDV + K2700 LDV gen 3	Rear	⊕ ⊕
GT2045	TOYOTA	End 98-May'05	Hilux P690 All 4x4 & raised body 4x2  Raider IFS gen 6 (N140, N150, N160, N170)	Front	⊥ ⊕
GT2046	TOYOTA	End 98-May'05	Hilux P690 All 4x4 & raised body 4x2  Raider IFS gen 6 (N140, N150, N160, N170)	Rear	○ ○
GT2051  > / GT2052  >	HONDA	92-95	Ballade All  local Encore & CRX ( those with rear bottom U brackets) Mk5 SR4 or EG	Front	⊥ ⊗
GT2051  > / GT2052  >	HONDA	92-95	Ballade All  imported Encore & CRX (With rear bottom U brackets) Mk5 EG or EH	Front	⊥ ⊗
GT2074	VOLKSWAGEN	52-79	Beetle (Type 1) All Built in RSA ( Beach Buggy)	Front	⊕ ⊕
GT2074	VOLKSWAGEN	57-68	Kombi, Panelvan & Microbus	Front	⊕ ⊕
GT2074	VOLKSWAGEN	75-79	Fleetline	Front	⊕ ⊕
GT2082	CHEVROLET	Aug '04-11	 Corsa Utility LDV	Rear	⊕ ⊕
GT2082	CHEVROLET	11-18	Utility LDV Petrol  Diesel front – will fit but may be a bit soft – Rear is ok for the Diesel /  Sport susp rear)	Rear	⊕ ⊕
GT2082	OPEL	8/04-10	Corsa Utility LDV	Rear	⊕ ⊕
GT2084	TOYOTA	Mid 93-97	Hi-Ace SWB Minibus (H50)	Front	⊥ ⊕
GT2084	BAW / CAM	07-13	Inyati minibus Taxi	Front	⊥ ⊕
GT2084	GONOW	08-14	Inguni Minibus Taxi	Front	⊥ ⊕
GT2084	GWM	08-11	H3 Hover4x2 & 4x4 SUV	Front	⊥ ⊕
GT2084	GWM	11-16	H5 SUV (X240)	Front	⊥ ⊕
GT2084	ISUZU	98-mid 03	Frontier Wagon, All 4x2 and 4X4 ( facelift)	Front	⊥ ⊕
GT2084	TOYOTA	Mid 00- 05	Condor 4x4	Front	⊥ ⊕
GT2084	TOYOTA	Mid 93-10	Hi-Ace LWB 16 Seater Minibus, Super 16 & Siyaya Taxi (H50)	Front	⊥ ⊕
GT2084	TOYOTA	Mid 93-10	Hi-Ace LWB Panelvan	Front	⊥ ⊕
GT2084	ISUZU	89-June'04	KB 4x4 & Raised body 4x2 ( all KB320) TF Series	Front	⊥ ⊕
GT2086 >	DATSUN	78-84	 160J & 180J Stanza Sedan ( S/Wagon)	Rear	⊥ ⊕
GT2088 >	TOYOTA	79-92	Stout	Front	⊥ ○
GT2091  GT2092 	TOYOTA	June'05-Jan 16	HiLux / Vigo std ht 4x2, gen 7 (AN10, AN20, AN30)	Front	⊥ ⊕
GT2091  GT2092 	TOYOTA	11 – 15	Innova 2.7 MPV (AN40)	Front	⊥ ⊕
GT2093	TOYOTA	June'05-Jan 16	HiLux / Vigo std ht 4x2, gen 7 (AN10, AN20, AN30)	Rear	○ ○
GT2094	FOTON	09-14	Inkunzi 2.2, 15 seater minibus taxi (LWB)	Front	⊥ ⊕
GT2094	FOTON	09-12	View panelvan (SWB)	Front	⊥ ⊕
GT2094	HYUNDAI	96-on	H100 Bakkie Dropside LDV gen 3 & 4	Front	⊥ ⊕

Key

*	See important installation information on inside front cover
!	Excluding self-levelling suspension
"..."	Special order – phone 010 900 1850. 6-12 week waiting period

~	Imported
#	Internal bump stop
⊕	Steering damper

- It is recommended that all new shock absorbers are fitted in pairs
- Do not mix gas and non-gas units on the same axle
- **Bold** part numbers indicate heavy-duty shocks
- Underlined part numbers indicate parts not immediately available
- *Italic* part numbers followed by > indicate parts to be discontinued

Passenger and light commercial

Part number [numerical listing]

Part number	Make	Year	Application	Position	Mounting information
GT2094	JinBei	15-on	H2L minibus taxi	Front	⊥ ⊕
GT2094	TOYOTA	19-on	Hi-Ace Ses'fikile 16 seater taxi & 14 Seater minibus (gen 5 H200)	Front	⊥ ⊕
GT2094	TOYOTA	05 – 19	Quantum 2.5,D, 2.7 Van & Minibus INC Ses'fikile taxi (gen 5 Hi-Ace H200) – For the newer 19-on model see Hi-Ace	Front	⊥ ⊕
GT2094	NISSAN	81-95	E20 van & Minibus	Front	⊥ ⊕
GT2096	FOTON	09-14	Inkunzi 2.2, 15 seater minibus taxi (LWB)	Rear	○ ○
GT2096	FOTON	09-12	View panelvan (SWB)	Rear	○ ○
GT2096	TOYOTA	88-93	Hi-Ace SWB Minibus (H50)	Rear	○ ○
GT2096	TOYOTA	85-10	Hi-Ace SWB + LWB 16 Seater Minibus, Super 16 & Siyaya Taxi (H50)	Rear	○ ○
GT2096	TOYOTA	85-10	Hi-Ace LWB Panelvan	Rear	○ ○
GT2102	BAW / CAM	07-13	Inyati minibus Taxi	Rear	○ ○
GT2102	GONOW	08-14	Inguni Minibus Taxi	Rear	○ ○
GT2102	JinBei	15-on	H2L minibus taxi	Rear	○ ○
GT2102	TOYOTA	19-on	Hi-Ace Ses'fikile 16 seater taxi & 14 Seater minibus (gen 5 H200)	Rear	○ ○
GT2102	TOYOTA	05 – 19	Quantum 2.5,D, 2.7 Van & Minibus INC Ses'fikile taxi (gen 5 Hi-Ace H200) – For the newer 19-on model see Hi-Ace	Rear	○ ○
GT2107	GWM	08-Oct '11	Steed 4x2 & 4x4 LDV ("Wingle" series)	Front	⊥ ⊕
GT2107	GWM	08-Oct '11	Steed 3 4x2 LDV ("Wingle" series)	Front	⊥ ⊕
GT2107	ISUZU	July'04-March '13	KB 4X2 Std Height P190 EXC Hi-Rider) RA / RC series	Front	⊥ ○
GT2109	KIA	end 04-14	K2700 1.3 ton & K2500 1.0 ton LDV gen 4	Rear	⊕ ⊕
GT2109	KIA	end 14-on	K2700 1.3 ton & K2500 1.0 ton LDV gen 4 facelift	Rear	⊕ ⊕
GT2112	FORD	July'07-11	Ranger 4x2 EXC Hi-Trail)	Rear	⊕ ⊕
GT2112	MAZDA	07-11	BT-50 4x2 std ht EXC Hi-Trail 4x2) gen 1 (UN)	Rear	○ ○
GT2201	AUDI	95- Jan'99	 A4 Sedan EXC Quattro, Sport) 8D, B5	Front	⊥ ⊗
GT2201	AUDI	95- Jan'99	 A4 Quattro Sedan EXC Sport,) 8D, B5	Front	⊥ ⊗
GT2201	AUDI	96- Jan'99	 A4 Avant EXC Quattro, Sport) 8D, B5	Front	⊥ ⊗
GT2201	AUDI	Feb'99-Nov'00	 A4 Sedan EXC Sport susp, Avant S/W & Quattro) B5, 8D	Front	⊥ ⊗
GT2201	AUDI	Feb'99-Nov'00	 A4 Avant EXC Sport susp, sedan & Quattro) B5, 8D	Front	⊥ ⊗
GT2202	AUDI	Dec '00- 04	 +  A4 Sedan & Avant + Quattro EXC Sport Susp, S4, & RS4) B6, 8E	Front	⊥ ⊗
GT2202	AUDI	05-07	 (S/W) A4 INC Quattro, Avant & Allroad EXC Sport susp, S4 & RS4) B7	Front	⊥ ⊗
GT2210	AUDI	May'03-12	A3 all INC Sportback EXC Quattro, Sport Susp & S3) OE Strut leg bottom outer diam = 50mm	Rear	⊥ ⊕
GT2210	AUDI	May'03-12	A3 all INC Sportback EXC Quattro, Sport Susp & S3) OE Strut leg bottom outer diam = 50mm OE Strut leg bottom outer diam = 55mm	Rear	⊥ ⊕
GT2210	AUDI	May'03-12	A3 & S3 Quattro and sport suspension 2.0 & 3.2 : 55mm OD strut only EXC S3 front & all RS3)	Rear	⊥ ⊕
GT2210	SEAT	06-10	Altea Mini MPV OE Strut leg outer diam = 50mm	Rear	⊥ ⊕
GT2210	SEAT	06-08	Leon Hatch EXC Cupra & Sport susp) OE Strut leg outer diam = 50mm	Rear	⊥ ⊕
GT2210	VOLKSWAGEN	07-15	Eos Cabriolet	Rear	⊥ ○
GT2210	VOLKSWAGEN	04-Feb'09	Golf V EXC Gti, V5, R32 & Sport susp) 1K1. OE Strut leg bottom outer diam = 50mm	Rear	⊥ ⊕
GT2210	VOLKSWAGEN	04-Feb'09	Golf V Gti & R32 INC 4 Motion AWD	Rear	⊥ ⊕
GT2210	VOLKSWAGEN	March '06-Sept'11	Jetta V EXC V5 & Sport susp) 1K2 (A5). Strut leg bottom outer diam = 50mm	Rear	⊥ ⊕
GT2210	VOLKSWAGEN	Oct '11-19	Jetta VI EXC V5 & Sport susp) 1B (A6) OE Strut leg bottom outer diam = 55mm 13mm Rod, Btm eye width 37mm	Rear	⊥ ⊕
GT2210	VOLKSWAGEN	05 – 11	  Passat Sedan & S/Wagon INC AWD 4 Motion Syncro EXC Sport Susp & Elec Susp) (B6)	Rear	⊥ ○
GT2210	VOLKSWAGEN	05 – 11	  Passat Sedan, & S/Wagon Sportline Sport Susp INC AWD 4 Motion Syncro EXC elec susp) (B6)	Rear	⊥ ○
GT2210	VOLKSWAGEN	09-17	Scirocco EXC elec, R or sport susp (137)	Rear	⊥ ○

Key







*	See important installation information on inside front cover
!	Excluding self-levelling suspension
"..."	Special order – phone 010 900 1850. 6-12 week waiting period

~	Imported
#	Internal bump stop
⊕	Steering damper

- It is recommended that all new shock absorbers are fitted in pairs
- Do not mix gas and non-gas units on the same axle
- **Bold** part numbers indicate heavy-duty shocks
- Underlined part numbers indicate parts not immediately available
- *Italic* part numbers followed by > indicate parts to be discontinued

Passenger and light commercial

Part number [numerical listing]

Part number	Make	Year	Application	Position	Mounting information
GT2210	VOLKSWAGEN	04-16	Touran MPV EXC Elec & heavy duty Susp (1T gen 1)	Rear	⊥ ⊕
GT2210	VOLKSWAGEN	11-Aug '15	Passat sedan EXC Sport Susp & 4WD 4 Motion Syncro) (B7) EXC elec susp	Rear	⊥ ○
GT2210 !	VOLKSWAGEN	09-17	"Passat" CC INC AWD 4 Motion Syncro EXC elec susp)	Rear	⊥ ○
GT2210 !	VOLKSWAGEN	March '09-13	Golf VI EXC Gti, V5, R32, AWD, Elec & Sport susp) OE Strut leg bottom outer diam = 50mm	Rear	⊥ ⊕
GT2210 !	VOLKSWAGEN	March '09-13	Golf VI Gti &,R32 INC 4 Motion AWD EXC elec susp	Rear	⊥ ⊕
GT2532 R GT2533 !	TOYOTA	16-on	HiLux "Revo" std ht 4x2, gen 8 (N120, N130)	Front	⊥ ⊕
GT2534	TOYOTA	16-on	HiLux "Revo" std ht 4x2, gen 8 (N120, N130)	Rear	○ ○
GT7005 R GT7006 !	TOYOTA	84-88	  Corolla sedan, Avante & Conquest F.W.D - EXC Twin Cam (E80)	Rear	⊕
GT7005 R GT7006 !	TOYOTA	Mid 85-88	  Corolla sedan, Avante & Conquest F.W.D - Narrow head Twin Cam (E80)	Rear	⊕
GT7101	VOLKSWAGEN	99-04	Golf IV & Jetta IV 1.6 only EXC Estate S/W) 20mm rod	Front	⊕
GT7101	VOLKSWAGEN	99-05	Golf IV 1.6 Estate S/Wagon	Front	⊕
GT7206	FORD	00-06	Ikon sedan All	Front	⊕
GT7206	FORD	97- Mid 99	Fiesta EXC Power steering) Mk4 (JA, JB)	Front	⊕
GT7206	FORD	Mid 99 -03	Fiesta EXC RSi) Mk4 facelift (JA, JB)	Front	⊕
GT7206	MAZDA	97- 99	121 Soho gen 4 (BE, JA, JB)	Front	⊕
GT7206	MAZDA	99 - 06	121 Soho gen 4 facelift (BE, JA, JB)	Front	⊕
GT7207	FORD	Dec '02-11	Bantam LDV	Front	⊕
GT7208 R GT7209 !	OPEL	02-11	Combo Panel Van (C)	Front	⊕
GT7208 R GT7209 !	OPEL	End 02-Oct '07	Corsa Hatch & Classic (sedan) EXC Lite) (C)	Front	⊕
GT7208 R GT7209 !	OPEL	03-09	Meriva 1.4, 1.6, 1.7CDTi, 1.8 mini MPV (A)	Front	⊕
GT7210	OPEL	96-02	Corsa Hatch & Notch (sedan) INC Corsa LITE & Lite Sport (B)	Front	⊕
GT7210	OPEL	02-15	Corsa LITE & Lite Sport - old shape Corsa hatch (B)	Front	⊕
GT7210	OPEL	96-Late 04	Corsa LDV	Front	⊕
GT7210	OPEL	98-02	Corsa Pronto Panel Van	Front	⊕
GT7216 >	MAZDA	83-93	626 Sedan (INC Coupe) RSA mnf model	Front	⊕
GT7218 R GT7219 !	TOYOTA	84-88	  Corolla sedan, Avante & Conquest F.W.D - EXC Twin Cam (E80)	Front	⊕
GT7220 >	HONDA	82-Mid 84	Ballade Mk2 (OS)	Front	⊕
GT7226 R GT7227 !	TOYOTA	Mid 85-88	  Corolla sedan, Avante & Conquest F.W.D - Narrow head Twin Cam (E80)	Front	⊕
GT7228	FORD	85-91	Laser & Meteor All (KC, KE)	Front	⊕
GT7228	MAZDA	85-91	323 (INC EG) F.W.D (BF 6th gen)	Front	⊕
GT7229	FORD	85-91	Laser & Meteor All (KC, KE)	Rear	⊕
GT7229	FORD	92 - 02	Laser & Meteor All INC Tracer (KF, KH)	Rear	⊕
GT7229	MAZDA	85-91	323 (INC EG) F.W.D (BF 6th gen)	Rear	⊕
GT7229	MAZDA	92-'03	323 All InclMidge & Sting (BF 6th gen)	Rear	⊕
GT7230	FORD	87-93	Bantam LDV	Front	⊕
GT7230	MAZDA	87-93	Rustler LDV	Front	⊕
GT7231	NISSAN	88-91	Sentra Sedan & Coupe InclTwincam (B12 Sunny)	Rear	⊕
GT7232	NISSAN	88-91	Sentra Sedan & Coupe InclTwincam (B12 Sunny)	Front	⊕
GT7233	FIAT	90-'09	Uno EXC raised body "Way" version from Brazil)	Front	⊕
GT7234 R GT7235 !	NISSAN	92- 7/01	Sentra 140 (B13 Sunny)	Rear	⊕

Key

*	See important installation information on inside front cover
!	Excluding self-levelling suspension
"..."	Special order - phone 010 900 1850. 6-12 week waiting period

~	Imported
#	Internal bump stop
⊕	Steering damper

- It is recommended that all new shock absorbers are fitted in pairs
- Do not mix gas and non-gas units on the same axle
- **Bold** part numbers indicate heavy-duty shocks
- Underlined part numbers indicate parts not immediately available
- *Italic* part numbers followed by > indicate parts to be discontinued

Passenger and light commercial

Part number [numerical listing]

Part number	Make	Year	Application	Position	Mounting information
GT7236	FORD	83-86	Bantam LDV	Front	
GT7236	FORD	Mid 81-86	Escort FWD	Front	
GT7239 GT7240	NISSAN	92- 7/01	Sentra 140 (B13 Sunny)	Front	
GT7239 GT7240	NISSAN	92- 7/01	Sentra & Sabre 160 (B13 Sunny)	Front	
GT7239 GT7240	NISSAN	92- 7/01	Sentra & Sabre 200 ABS (B13 Sunny)	Front	
GT7241	FORD	95- 99	Escort	Front	
GT7241	FORD	95- 99	(S/W) Escort S/Wagon	Front	
GT7242 GT7243	TOYOTA	98-06	Conquest Carri Panel Van	Rear	
GT7242 GT7243	TOYOTA	89-96	Corolla & Conquest Twin Cam & 1800 F.W.D P140 (EE90, AE92, CE90)	Rear	
GT7242 GT7243	TOYOTA	96-June'06	Conquest / Tazz (EE90, AE92)	Rear	
GT7242 GT7243	TOYOTA	96-June'06	Tazz	Rear	
GT7244 GT7245	TOYOTA	96-Oct '02	Corolla Sedan P160 gen 7 Rsi & Rxi (E100, AE101)	Rear	
GT7249	VOLKSWAGEN	85-93	Golf II & Jetta II	Front	
GT7249	VOLKSWAGEN	92-94	Golf III & Jetta III VR6	Front	
GT7251	FORD	92 - 02	Laser & Meteor All Tracer (KF, KH)	Front	
GT7251	MAZDA	92-'03	323 All Incl Midge & Sting (BF 6th gen)	Front	
GT7252	FORD	94-Nov'02	Bantam LDV	Front	
GT7252	MAZDA	94-10	Rustler LDV	Front	
GT7253 GT7254	MAZDA	94- 99	Etude BH / Astina BA - J55 (RSA Mnf)	Front	
GT7255 GT7256	MAZDA	94- 99	Etude BH / Astina BA - J55 (RSA Mnf)	Rear	
GT7261 GT7262	NISSAN	01 - May'06	Almera Sedan Hatch (N16) ABS	Front	
GT7263 GT7264	CHEVROLET	Aug '04-11	Corsa Utility LDV	Front	
GT7263 GT7264	OPEL	8/04-10	Corsa Utility LDV	Front	
GT7278	VOLKSWAGEN	78-92	Golf I / Jetta I & Citi	Front	
GT7278	VOLKSWAGEN	93-10	CITI -	Front	
GT7278	VOLKSWAGEN	98-10	Citi - Sonic, Life & VeloCiti Slight OE lowering	Front	
GT7278	VOLKSWAGEN	81-09	Golf LDV	Front	
GT7279 GT7280	NISSAN	07-13	Livina MPV 7 seater	Front	
GT7279 GT7280	NISSAN	Aug '06 -13	Tiida 1.6 & 1.8 Hatch / Sedan gen 1 (X11C)	Front	
GT7417	CHEVROLET	11-18	Utility LDV Petrol	Front	
GT8020	AUDI	98-April '03	A3 1.8 & 1.8T turbo, 1.9TDi	Front	
GT8020	AUDI	98-April '03	A3 Sport Susp	Front	
GT8020	VOLKSWAGEN	99-Oct '12	New Beetle (Type 2)	Front	
GT8020	VOLKSWAGEN	99-04	Golf IV & Jetta IV 1.8, Gti Turbo, 1.9 Tdi, 2.0, 2.3 V5	Front	
GT8020	VOLKSWAGEN	00-05	Golf IV 1.9 Tdi Estate S/Wagon	Front	
GT8021 GT8022	TOYOTA	Nov'02-Sept'07	Corolla Sedan & RunX Hatch	Front	
GT8023 >	SEAT	06-08	Ibiza Hatch & Sedan	Front	
GT8023 >	VOLKSWAGEN	Oct '02-Jan'10	Polo Hatch & Classic Sedan	Front	

Key

	See important installation information on inside front cover
	Excluding self-leveling suspension
	Special order - phone 010 900 1850. 6-12 week waiting period

	Imported
	Internal bump stop
	Steering damper

- It is recommended that all new shock absorbers are fitted in pairs
- Do not mix gas and non-gas units on the same axle
- **Bold** part numbers indicate heavy-duty shocks
- Underlined part numbers indicate parts not immediately available
- *Italic* part numbers followed by > indicate parts to be discontinued

Passenger and light commercial

Part number [numerical listing]

Part number	Make	Year	Application	Position	Mounting information
GT8024 R GT8025 L	OPEL	01-Sept'04	(S/W) Astra Caravan S/Wagon (G)	Front	
GT8024 R GT8025 L	OPEL	01-06	Astra Coupe & Cabriolet (G)	Front	
GT8024 R GT8025 L	OPEL	Nov'99-Sept'04	Astra hatch & Classic sedan (G) EXC1 OPC & S/W	Front	
<i>GT8026</i> > R <i>GT8027</i> > L	NISSAN	92- 7/01	Sentra & Sabre 200 EXC1 ABS (B13 Sunny) (Flat on piston rod)	Rear	
GT8028 R GT8029 L	FORD	93-'99	Telstar Sedan & TX5	Front	
GT8028 R GT8029 L	MAZDA	93-Mid 99	626 Sedan All INC1 MX6 (GE)	Front	
GT8028 R GT8029 L	MAZDA	93-Mid 99	MX-6	Front	
GT8030	FORD	93-'99	Telstar Sedan & TX5	Rear	
GT8030	MAZDA	93-Mid 99	626 Sedan All INC1 MX6 (GE)	Rear	
GT8030	MAZDA	93-Mid 99	MX-6	Rear	
GT8031 R GT8032 L	NISSAN	92- 7/01	Sentra & Sabre 160 (B13 Sunny) (Flat on piston rod)	Rear	
GT8031 R GT8032 L	NISSAN	92- 7/01	Sentra & Sabre 200 EXC1 ABS (B13 Sunny) (Flat on piston rod)	Rear	
GT8033 R GT8034 L	TOYOTA	93-Late 97	Camry (RSA mnf) V30, XV10 gen 3	Rear	
GT8033 R GT8034 L	TOYOTA	Late 97- Aug '01	Camry (RSA mnf) V30, XV10 gen 3	Rear	
GT8035 R GT8036 L	TOYOTA	93-Late 97	Camry (RSA mnf) V30, XV10 gen 3 Bolted S/Pan -not INC1 (re-use OE S/Pan)	Front	
GT8037	VOLKSWAGEN	95-99	Golf III & Jetta III INC1 Gti & Cli EXC1 VR6)	Front	
GT8037	VOLKSWAGEN	93-99	Golf III & Jetta III VR6	Front	
GT8037	VOLKSWAGEN	93-'04	Golf III & IV Cabriolet EXC1 16" wheels)	Front	
GT8037	VOLKSWAGEN	98-Sept'02	Polo Playa Hatch & Classic Sedan (mk 3 6N) EXC1 sport susp	Front	
GT8038 R GT8039 L	TOYOTA	Late 97- Aug '01	Camry (RSA mnf) V30, XV10 gen 3	Front	
GT8042 R GT8043 L	TOYOTA	96-Oct '02	Corolla Sedan P160 gen 7 INC1 Rsi & Rxi (E100, AE101)	Front	
GT8046 R GT8047 L	TOYOTA	98-06	Conquest Carri Panel Van	Front	
GT8046 R GT8047 L	TOYOTA	89-96	Corolla & Conquest INC1 Twin Cam & 1800 F.W.D P140 (EE90, AE92, CE90)	Front	
GT8046 R GT8047 L	TOYOTA	96-June'06	Conquest / Tazz (EE90, AE92)	Front	
GT8046 R GT8047 L	TOYOTA	96-June'06	Tazz	Front	
<i>GT8056</i>	AUDI	11 - Sept '18	Q3 2.0TDi, 2.0T 4x2 & 4x4 Quattro (EXC1 RS 2.5 sport or elec susp) 8U	Front	
<i>GT8056</i> >	AUDI	May 03-12	A3 all INC1 Sportback EXC1 Quattro, Sport Susp & S3) OE Strut leg bottom outer diam = 55mm	Front	
<i>GT8056</i> >	VOLKSWAGEN	Oct '12-17	New Beetle (Type 2 / A5) 55mm front strut body	Front	
<i>GT8056</i> >	VOLKSWAGEN	04 - May 15	Caddy All gen 3 (2K) 55mm OD Strut tube	Front	
<i>GT8056</i> >	VOLKSWAGEN	07-15	Eos Cabriolet	Front	
<i>GT8056</i> >	VOLKSWAGEN	04-Feb'09	Golf V Gti & R32 INC1 4 Motion AWD	Front	
<i>GT8056</i> >	VOLKSWAGEN	March '09-13	Golf VI Gti & R32 INC1 4 Motion AWD EXC1 elec susp	Front	
<i>GT8056</i> >	VOLKSWAGEN	March '06-Sept'11	Jetta V (Sport susp) 1K2 (A5) OE Strut leg bottom outer diam = 55mm	Front	
<i>GT8056</i> >	VOLKSWAGEN	05 - 11	Passat Sedan, & S/Wagon Sportline Sport Susp INC1 AWD 4 Motion Syncro EXC1 elec susp) (B6)	Front	
<i>GT8056</i> >	VOLKSWAGEN	09-17	Scirocco EXC1 elec, R or sport susp (137)	Front	
<i>GT8056</i> >	VOLKSWAGEN	08-Sept 16	Tiguan 4 Motion AWD & FWD INC1 Blue Motion EXC1 elec susp) gen 1 (5N)	Front	
<i>GT8056</i> >	VOLKSWAGEN	04-16	Touran MPV EXC1 Elec & heavy duty Susp (1T gen 1)	Front	

Key

*	See important installation information on inside front cover
!	Excluding self-levelling suspension
"..."	Special order - phone 010 900 1850. 6-12 week waiting period

~	Imported
#	Internal bump stop
⊕	Steering damper

- It is recommended that all new shock absorbers are fitted in pairs
- Do not mix gas and non-gas units on the same axle
- **Bold** part numbers indicate heavy-duty shocks
- Underlined part numbers indicate parts not immediately available
- *Italic* part numbers followed by > indicate parts to be discontinued

Passenger and light commercial

Part number [numerical listing]

Part number	Make	Year	Application	Position	Mounting information
GT8057	AUDI	May'03-12	A3 all MC Sportback EXC Quattro, Sport Susp & S3) OE Strut leg bottom outer diam = 55mm	Front	
GT8057	AUDI	11 - Sept '18	Q3 2.0TDi, 2.0T 4x2 & 4x4 Quattro EXC RS 2.5 sport or elec susp) 8U	Front	
GT8057	VOLKSWAGEN	Oct '12-17	New Beetle (Type 2 / A5) 55mm front strut body	Front	
GT8057	VOLKSWAGEN	09-17	"Passat" CC MC AWD 4 Motion Syncro EXC elec susp)	Front	
GT8057	VOLKSWAGEN	04 - May 15	Caddy All gen 3 (2K) 55mm OD Strut tube	Front	
GT8057	VOLKSWAGEN	June 15-Oct '21	Caddy All gen 3, (2K Facelift)	Front	
GT8057	VOLKSWAGEN	07-15	Eos Cabriolet	Front	
GT8057	VOLKSWAGEN	04-Feb'09	Golf V EXC Gti, V5, R32 & Sport susp) 1K1 OE Strut leg outer diam = 55mm Check sticker on OE shock: 1T0 412 103 A	Front	
GT8057	VOLKSWAGEN	04-Feb'09	Golf V Gti & R32 MC 4 Motion AWD	Front	
GT8057	VOLKSWAGEN	March '09-13	Golf VI EXC Gti, V5, R32, AWD, Elec & Sport susp) OE Strut leg bottom outer diam = 55mm	Front	
GT8057	VOLKSWAGEN	March '06-Sept'11	Jetta V EXC V5 & Sport susp) 1K2 (A5) (std susp) OE Strut leg bottom outer diam = 55mm	Front	
GT8057	VOLKSWAGEN	March '06-Sept'11	Jetta V (Sport susp) 1K2 (A5) OE Strut leg bottom outer diam = 55mm	Front	
GT8057	VOLKSWAGEN	Oct '11-19	Jetta VI EXC V5 & Sport susp) 1B (A6) OE Strut leg bottom outer diam = 55mm	Front	
GT8057	VOLKSWAGEN	05 - 11	Passat Sedan & S/Wagon MC AWD 4 Motion Syncro EXC Sport Susp & Elec Susp) (B6)	Front	
GT8057	VOLKSWAGEN	05 - 11	Passat Sedan, & S/Wagon Sportline Sport Susp MC AWD 4 Motion Syncro EXC elec susp) (B6)	Front	
GT8057	VOLKSWAGEN	11-Aug '15	Passat sedan EXC Sport Susp & 4WD 4 Motion Syncro) (B7) EXC elec susp	Front	
GT8057	VOLKSWAGEN	09-17	Scirocco EXC elec, R or sport susp (137)	Front	
GT8057	VOLKSWAGEN	08-Sept 16	Tiguan 4 Motion AWD & FWD MC Blue Motion EXC elec susp) gen 1 (5N)	Front	
GT8057	VOLKSWAGEN	04-16	Touran MPV EXC Elec & heavy duty Susp (1T gen 1)	Front	
GT8057 !	VOLKSWAGEN	March '09-13	Golf VI Gti & R32 MC 4 Motion AWD EXC elec susp	Front	
GT8058	AUDI	May'03-12	A3 all MC Sportback EXC Quattro, Sport Susp & S3) OE Strut leg bottom outer diam = 50mm	Front	
GT8058	SEAT	06-10	Altea Mini MPV OE Strut leg outer diam = 50mm	Front	
GT8058	SEAT	06-08	Leon Hatch EXC Cupra & Sport susp) OE Strut leg outer diam = 50mm	Front	
GT8058	VOLKSWAGEN	Oct '12-17	New Beetle (Type 2 / A5) 50mm front strut body	Front	
GT8058	VOLKSWAGEN	04 - May 15	Caddy All gen 3 (2K) 50mm OD strut tube	Front	
GT8058	VOLKSWAGEN	04-Feb'09	Golf V EXC Gti, V5, R32 & Sport susp) 1K1 OE Strut leg outer diam = 50mm Check sticker on OE shock: 1K0 412 103 B	Front	
GT8058	VOLKSWAGEN	March '06-Sept'11	Jetta V EXC V5 & Sport susp) 1K2 (A5). Strut leg bottom outer diam = 50mm	Front	
GT8058	VOLKSWAGEN	Oct '11-19	Jetta VI EXC V5 & Sport susp) 1B (A6) OE Strut leg bottom outer diam = 50mm	Front	
GT8058	VOLKSWAGEN	March '09-13	Golf VI EXC Gti, V5, R32, AWD, Elec & Sport susp) OE Strut leg bottom outer diam = 50mm	Front	
GT8072	TOYOTA	Sept'01-06	Camry (Australian mnf) ACV30, ACV31, ACV36, MCV30, MCV36, XV30 gen 6	Front	
GT8074	TOYOTA	Sept'01-06	Camry (Australian mnf) ACV30, ACV31, ACV36, MCV30, MCV36, XV30 gen 6	Rear	
GT8075	TOYOTA	Sept'01-06	Camry (Australian mnf) ACV30, ACV31, ACV36, MCV30, MCV36, XV30 gen 6	Rear	
GT8123	AUDI	11-May 18	A1 Gen 1 (8X) EXC Sport susp (122 PS)	Front	
GT8123	SEAT	06-08	Ibiza Hatch & Sedan EXC sport susp)	Front	
GT8123	VOLKSWAGEN	Oct '02-Jan'10	Polo Hatch & Classic Sedan EXC CrossPolo (mk 4 9N3)	Front	
GT8123	VOLKSWAGEN	Feb'10-Jan '18	Polo Hatch, EXC Vivo, Sedan & Cross, Gti, Sport susp (mk 5 model, 6R, 6C)	Front	
GT8123	VOLKSWAGEN	Feb'10-19	Polo Sedan, EXC Vivo, Gti, hatch (mk 5 model, 6V2)	Front	
GT8123	VOLKSWAGEN	10/02-1/10	CrossPolo & Vivo Maxx EXC Sport Susp (mk 4 9N3)	Front	
GT8123	VOLKSWAGEN	11-18	CrossPolo & Vivo Maxx EXC Sport Susp (mk 5 6R)	Front	
GT8123	VOLKSWAGEN	Feb'10-Feb '18	Polo VIVO Std susp (mk 4 9N3) EXC Maxx, GT & Sport susp	Front	
GT8123	VOLKSWAGEN	March 18-on	Polo VIVO std susp (mk 5 model, 6R, 6C) EXC Maxx, GT & Sport susp	Front	

Key



























































*	See important installation information on inside front cover
!	Excluding self-levelling suspension
...	Special order - phone 010 900 1850. 6-12 week waiting period

~	Imported
#	Internal bump stop
⊕	Steering damper

- It is recommended that all new shock absorbers are fitted in pairs
- Do not mix gas and non-gas units on the same axle
- **Bold** part numbers indicate heavy-duty shocks
- Underlined part numbers indicate parts not immediately available
- *Italic* part numbers followed by > indicate parts to be discontinued

Passenger and light commercial

Part number [numerical listing]

Part number	Make	Year	Application	Position	Mounting information
GT8272  GT8273 	TOYOTA	06-12	 (S/W) Corolla Axio & Fielder S/W (E140 narrow body jap model) Cross border export mkt	Front	
GT8625	AUDI	June 18 – on	A1 Sportback Gen 2 (6B) 30TFSI (1,0), 35TFSI (1,5), 40TFSI (2,0)  Sport susp	Front	
GT8625	VOLKSWAGEN	Feb '18 – on	 Polo Hatch,  Vivo, Sedan & Cross (mk 6, model AW)	Front	
GT8625	VOLKSWAGEN	20 – on	 Polo 1.6 Sedan (mk 5 facelift)	Front	
GT8625	VOLKSWAGEN	19-on	T-Cross SUV (C11)	Front	
M4434	TOYOTA	85-87	"Grey" UN Import Landcruiser 60 series FJ60 / FJ62 S/Wagon (Model: #J6##V...) Raised 25mm	Front	
M4434	TOYOTA	87- 99	Landcruiser HZJ75 series LDV leaf springs Standard Susp	Front	
M4441	DATSUN	80-87	720 Series, 1800, 2200 LDV	Rear	
M4441	FORD	85-98	Husky Minibus, LDV, Panelvan	Rear	
M4441	FUDI	08-15	Lion 2.2, 2.8 4x2 LDV	Rear	
M4441	GONOW	08-on	X-Space 2.2, 2.8 4x2 LDV	Rear	
M4441	GWM	07-11	GWM pick-up 2.2, 2.8 Tdi 4x2	Rear	
M4441	ISUZU	Mid 81-89	KB21, KB23, KB28, KBD22, KBD27 4X2	Rear	
M4441	ISUZU	Mid 81-89	KB41, KB43, KBD42 4x4	Rear	
M4441	ISUZU	89-June'04	KB 4x2 std height  raised body & KB320) TF Series	Rear	
M4441	ISUZU	89-June'04	KB 4x4 & Raised body 4x2 ( all KB320) TF Series	Rear	
M4441	ISUZU	92-02	Trooper UBS 69 & UBS 26/73 series	Rear	
M4441	ISUZU	84-95	WFR Van & Bus ( Relay)	Rear	
M4441	KIA	98-04	Ceres dropside LDV + K2700 LDV gen 3	Rear	
M4441	MINIBUS	83-04	L300 LDV ( minibus)	Rear	
M4441	NISSAN	82-88	Sani Wagon 4x4	Rear	
M4441	NISSAN	82-88	Tracker (4x4) ( Sani)	Rear	
M4441	TOYOTA	84-End'98	Hilux All 4x2 (N50, N60)	Rear	
M4441	TOYOTA	End 98-May'05	Hilux P690 4x2 IFS  raised body gen 6 (N140, N150, N160, N170)	Rear	
M4441	TOYOTA	87- 01	Stallion LDV & Van	Rear	
M4441	TOYOTA	91- mid 00	Venture Wagon  "Getaway"	Rear	
M4441	TOYOTA	83-89	Landcruiser 60 series S/Wagon Models #J6##V-... (FJ60, FJ62, HJ60, HJ6) Std Susp	Rear	
M4441	TOYOTA	72-86	Landcruiser 40 series LDV leaf springs	Rear	
M4445	MINIBUS	82-96	Canter (A.D.E. Engine)	Rear	
M4445	TOYOTA	84-End'98	Hilux All 4x4 (N505, N60) Standard susp	Rear	
M4445	TOYOTA	84-End'98	Hilux All 4x4 (N505, N60) Raised +-20 to 40mm	Rear	
M4445	TOYOTA	End 98-May'05	Hilux P690 All 4x4 & raised body 4x2  Raider IFS gen 6 (N140, N150, N160, N170)	Rear	
M4445	TOYOTA	85-March '89	4-Runner & Surf RN61, LN 61 & YN63 4x4 IFS  elec susp (N60)	Rear	
M4462	DATSUN	65-80	1200, 1300, 1500, 1600, 620, 680 LDV (520, 521, 620 series)	Front	
M4462	DATSUN	80-87	720 Series, 1800, 2200 LDV	Front	
M4462	FOTON	10-16	Thunda 2.2, 2.8 pick up	Front	
M4462	ISUZU	Mid 81-89	KB21, KB23, KB28, KBD22, KBD27 4X2	Front	
M4462	NISSAN	88- mid 99	1 Tonner 4x4 (AW)  Hardbody, Sani, D/Cab & Diesel (MD21)	Front	
M4462	NISSAN	82-88	Sani Wagon 4x4	Front	
M4462	NISSAN	88-00	Sani Wagon 4x4	Front	
M4462	NISSAN	80-82	Tracker (4x4)	Front	
M4462	NISSAN	82-88	Tracker (4x4) ( Sani)	Front	

Key

*	See important installation information on inside front cover
!	Excluding self-levelling suspension
"..."	Special order – phone 010 900 1850. 6-12 week waiting period

~	Imported
#	Internal bump stop
⊕	Steering damper

- It is recommended that all new shock absorbers are fitted in pairs
- Do not mix gas and non-gas units on the same axle
- **Bold** part numbers indicate heavy-duty shocks
- Underlined part numbers indicate parts not immediately available
- *Italic* part numbers followed by > indicate parts to be discontinued

Passenger and light commercial

Part number [numerical listing]

Part number	Make	Year	Application	Position	Mounting information
M4464	MITSUBISHI	82-96	Canter (A.D.E. Engine)	Front	⊥ ○
M4464	ISUZU	98-mid 03	Frontier Wagon, All 4x2 and 4X4 (M) facelift	Rear	⊥ ○
M4464	ISUZU	87-91	Trooper UBS 12/52 series	Rear	⊥ ○
M4464	SSANGYONG	95-06	Musso 602TDi, E230EL, E320EL 4x4	Rear	⊥ ○
M5454	TOYOTA	79-84	Hilux 4x4 N30, N40	Front	⊥ ⊕
M5454	TOYOTA	84-End'98	Hilux All 4x4 (N505, N60) Standard susp	Front	⊥ ⊕
M5464	BAW / CAM	07-13	Inyati minibus Taxi	Front	⊥ ⊕
M5464	FOTON	09-14	Inkunzi 2.2, 15 seater minibus taxi (LWB)	Front	⊥ ⊕
M5464	FOTON	09-12	View panelvan (SWB)	Front	⊥ ⊕
M5464	GONOW	08-14	Inguni Minibus Taxi	Front	⊥ ⊕
M5464	ISUZU	98-mid 03	Frontier Wagon, All 4x2 and 4X4 (M) facelift	Front	⊥ ⊕
M5464	ISUZU	89- June '04	KB 4x4 & Raised body 4x2 (M) all KB320) TF Series	Front	⊥ ⊕
M5464	ISUZU	87-91	Trooper UBS 12/52 series	Front	⊥ ⊕
M5464	ISUZU	92-02	Trooper UBS 69 series	Front	⊥ ⊕
M5464	ISUZU	97-02	Trooper UBS 26/73 series	Front	⊥ ⊕
M5464	LIFAN	12-18	Amandla 14 seater minibus taxi	Front	⊥ ⊕
M5464	MAHINDRA	05-15	Scorpio 4x4 SUV (S10) gen 1 4x4 (Check mountings for correct applications)	Front	⊥ ⊕
M5464	MAHINDRA	06 -15	Scorpio Pik-Up Single & D/C 4x2 & 4x4 LDV gen 1	Front	⊥ ⊕
M5464	MAHINDRA	16 - on	Pik-Up Single & D/C 4x2 & 4x4 LDV gen 1 facelift (B) Raised models)	Front	⊥ ⊕
M5464	SSANGYONG	95-06	Musso 602TDi, E230EL, E320EL 4x4	Front	⊥ ⊕
M5464	SSANGYONG	04-05	Musso Sport D/C LDV	Front	⊥ ⊕
M5464	TOYOTA	Mid 00- 05	Condor 4x4	Front	⊥ ⊕
M5464	TOYOTA	Mid 93-97	Hi-Ace SWB Minibus (H50)	Front	⊥ ⊕
M5464	TOYOTA	Mid 93-10	Hi-Ace LWB 16 Seater Minibus, Super 16 & Siyaya Taxi (H50)	Front	⊥ ⊕
M5464	TOYOTA	Mid 93-10	Hi-Ace LWB Panelvan	Front	⊥ ⊕
M5468	FOTON	10-16	Thunda 2.2, 2.8 pick up	Front	⊥ ⊕
M5468	FUDI	08-15	Lion 2.2, 2.8 4x2 LDV	Front	⊥ ⊕
M5468	KIA	98-01	Ceres dropside LDV gen 3	Front	⊥ ⊕
M5468	KIA	01-04	K2700 LDV gen 3	Front	⊥ ⊕
M5468	KIA	end 04-14	K2700 1.3 ton & K2500 1.0 ton LDV gen 4	Front	⊥ ⊕
M5468	KIA	01 - 04	Pregio 12 seater minibus	Front	⊥ ⊕
M5468	MAHINDRA	05-15	Bolero 2.5 Td 4x2 Single & D/C LDV 4x2 (Check mountings for the correct application)	Front	⊥ ⊕
M5468	TOYOTA	84-End'98	Hilux All 4x2 (N50, N60)	Front	⊥ ⊕
M5468	TOYOTA	End 98-May'05	Hilux P690 4x2 IFS (B) raised body gen 6 (N140, N150, N160, N170)	Front	⊥ ⊕
M6409	TOYOTA	07-on	Landcruiser 76 & 78 series S/Wagon (Coil front, leaf rear) Std Susp	Rear	○ ○
M6409	TOYOTA	87- 99	Landcruiser HZJ75 series LDV leaf springs Standard Susp	Rear	○ ○
M6409	TOYOTA	99-on	Landcruiser HZJ79 series LDV Rear leaf springs, Coil front Std Susp	Rear	○ ○
M6432	TOYOTA	End 98-May'05	Hilux P690 All 4x4 & raised body 4x2 (M) Raider IFS gen 6 (N140, N150, N160, N170)	Front	⊥ ⊕
M6432	TOYOTA	85-March '89	4-Runner & Surf RN61, LN 61 & YN63 4x4 IFS (B) elec susp (N60)	Front	⊥ ⊕
M6432	TOYOTA	April '89 - 95	4-Runner & Surf gen 2 LN130, VZN130 (B) elec susp, RZN180, RZN185, VZN185 (N120, N130)	Front	⊥ ⊕
M6628	LAND ROVER	76-96	Range Rover Classic gen 1 (B) Air Susp.)	Front	⊥ T
M6628	LAND ROVER	84-16	90, 110 Defender SW & 130" Double Cab LDV (L316 & L317)	Front	⊥ T

Key

*	See important installation information on inside front cover
!	Excluding self-levelling suspension
"..."	Special order - phone 010 900 1850. 6-12 week waiting period

~	Imported
#	Internal bump stop
⊕	Steering damper

- It is recommended that all new shock absorbers are fitted in pairs
- Do not mix gas and non-gas units on the same axle
- **Bold** part numbers indicate heavy-duty shocks
- Underlined part numbers indicate parts not immediately available
- *Italic* part numbers followed by > indicate parts to be discontinued

Passenger and light commercial

Part number [numerical listing]

Part number	Make	Year	Application	Position	Mounting information
M6628	LAND ROVER	89-94	Discovery I	Front	⊥ T
M6629	LAND ROVER	84-16	90, 110 Defender SW & 130" Double Cab LDV (L316 & L317)	Rear	⊖ T
M6629	LAND ROVER	89-94	Discovery I	Rear	⊖ T
M6629	LAND ROVER	76-96	Range Rover Classic gen 1 (Exc Air Susp.)	Rear	⊖ T
M6902	JMC	10-16	Boarding Pick-up 4x2 & 4x4	Rear	⊖ ⊖
M6902	MITSUBISHI	95-End 98	L200 Colt 4X4	Rear	○ ○
M6902	TATA	04 -16	Telcoline 2.0 4x2 & 4x4 LDV (Exc) 3.0 Diesel Worker	Rear	○ ○
M6902	TATA	07-19	Xenon 4x2 & 4x4 LDV (excludes models with front top eye mountings)	Rear	○ ○
M7299	MITSUBISHI	91- 99	Pajero 4x4 gen 2 V Series: V21, V24, V41, V44, V46 coil rear (NH, NJ, NK, NL) (Exc elec susp)	Front	⊥ ⊖
M7300	MITSUBISHI	91- 99	Pajero 4x4 gen 2 V Series: V21, V24, V41, V44, V46 coil rear (NH, NJ, NK, NL) (Exc elec susp)	Rear	⊥ ⊖
M7366	FORD	86-Jan'00	Courier All 4X4	Front	⊥ ⊖
M7366	FORD	09-Sept '15	Everest SUV 4x2 & 4x4 (U268)	Front	⊥ ⊖
M7366	FORD	Feb'00-June'07	Ranger 4x4 & 4x2 Hi-Trail raised body	Front	⊥ ⊖
M7366	FORD	July'07-11	Ranger 4x4 & 4x2 Hi-Trail raised body	Front	⊥ ⊖
M7366	MAZDA	86- 3/00	B Series Magnum All 4x4	Front	⊥ ⊖
M7366	MAZDA	4/00-07	Drifter 4x4 & Hi-Trail 4x2	Front	⊥ ⊖
M7366	MAZDA	07-11	BT-50 4x4 & Hi-Trail 4x2 gen 1 (UN)	Front	⊥ ⊖
M7366	TATA	04 -16	Telcoline 2.0 4x2 & 4x4 LDV (Exc) 3.0 Diesel Worker	Front	⊥ ⊖
M7366	TATA	07-19	Xenon 4x2 & 4x4 LDV (excludes models with front top eye mountings)	Front	⊥ ⊖
M7367	FORD	86-Jan'00	Courier All 4X4	Rear	⊖ ⊖
M7367	FORD	09-Sept '15	Everest SUV 4x2 & 4x4 (U268)	Rear	⊖ ⊖
M7367	FORD	Feb'00-June'07	Ranger 4x4 & 4x2 Hi-Trail raised body	Rear	⊖ ⊖
M7367	FORD	July'07-11	Ranger 4x4 & 4x2 Hi-Trail raised body	Rear	⊖ ⊖
M7367	MAZDA	86- 3/00	B Series Magnum All 4x4	Rear	⊖ ⊖
M7367	MAZDA	4/00-07	Drifter 4x4 & Hi-Trail 4x2	Rear	⊖ ⊖
M7367	MAZDA	07-11	BT-50 4x4 & Hi-Trail 4x2 gen 1 (UN)	Rear	⊖ ⊖
M8029	NISSAN	Mid 99-07	Hardbody 4x4 & 4x2 Hi-Rider D/C (QW) LDV D22	Rear	○ ○
M8029	NISSAN	08-21	NP300 4x4 & 4x2 Hi-Rider D/C LDV (D22)	Rear	○ ○
M8030	NISSAN	Mid 99-07	Hardbody 4x4 & 4x2 Hi-Rider D/C (QW) LDV D22	Front	⊥ ⊖
M8030	NISSAN	08-21	NP300 4x4 & 4x2 Hi-Rider D/C LDV (D22)	Front	⊥ ⊖
M8031	GWM	08-11	H3 Hover4x2 & 4x4 SUV	Front	⊥ ⊖
M8031	GWM	11-16	H5 SUV (X240)	Front	⊥ ⊖
M8031	ISUZU	July'04-March '13	KB 4X4 P190 & 4x2 Hi-Rider raised body RA / RC series Std height Torsion bars	Front	⊥ ○
M8031	MAHINDRA	05-15	Bolero 2.5 Td 4x4 Single & D/C LDV 4x4 (Check mountings for the correct application)	Front	⊥ ○
M8032	GWM	08-Oct '11	Steed 4x2 & 4x4 LDV ("Wingle" series)	Rear	○ ○
M8032	ISUZU	July'04-March '13	KB 4X2 Std Height P190 (Exc) Hi-Rider) RA / RC series	Rear	○ ○
M8032	ISUZU	July'04-March '13	KB 4X4 P190 & 4x2 Hi-Rider raised body RA / RC series Std height	Rear	○ ○
M8034	FORD	67-69	F100 & F250 (4x2)	Front	⊥ ⊖
M8034	FORD	70-81	F100 & F250 (4x2)	Front	⊥ ⊖
M8034	FORD	75-81	F350	Front	⊥ ⊖
M8036	LAND ROVER	54-83	86", 88" & 107" SWB (Series I, II, IIA, IIB & III)	Front	○ ○
M8036	LAND ROVER	58-84	109" & 119" LWB (Exc) S/Wagon) Series II, IIA, IIB&III	Front	○ ○

Key

*	See important installation information on inside front cover
!	Excluding self-levelling suspension
"..."	Special order - phone 010 900 1850. 6-12 week waiting period

~	Imported
#	Internal bump stop
⊖	Steering damper

- It is recommended that all new shock absorbers are fitted in pairs
- Do not mix gas and non-gas units on the same axle
- **Bold** part numbers indicate heavy-duty shocks
- Underlined part numbers indicate parts not immediately available
- *Italic* part numbers followed by > indicate parts to be discontinued

Passenger and light commercial

Part number [numerical listing]

Part number	Make	Year	Application	Position	Mounting information
M8036	MAHINDRA	05-15	Scorpio 4x2 & 4x4 SUV (S10) gen 1 (Check mountings for correct applications)	Rear	○ ○
<i>M8037</i> ~	LAND ROVER	58-84	109" & 119" LWB (incl S/Wagon) Series II, IIA, IIB&III	Rear	○ T
M8038	CHEVROLET	72-78	LUV	Rear	○ ○
M8038	FORD	65-67	F100 & F250 (4x2)	Rear	○ ○
M8038	FORD	67-69	F100 & F250 (4x2)	Rear	○ ○
M8038	GWM	08-Oct '11	Steed 3 4x2 LDV ("Wingle" series)	Rear	○ ○
M8038	GWM	08-on	Steed 5 & 5E 4x2 & 4x4 LDV ("Wingle" series)	Rear	○ ○
M8038	HYUNDAI	96-on	H100 Bakkie Dropside LDV gen 3 & 4	Rear	○ ○
M8038	ISUZU	78-Mid 81	KB10, KA20, KA25	Rear	○ ○
M8038	LADA	FM_M00G	Niva 4x4	Rear	⊖ ⊖
M8038	MAHINDRA	05 -15	Scorpio 4x2 & 4x4 SUV (S10) gen 1 (Check mountings for correct applications)	Rear	○ ○
M8038	TOYOTA	Mid 00- 05	Condor 4x4	Rear	○ ○
M8038	TOYOTA	61-79	Stout RK101	Rear	○ ○
M8038	TOYOTA	79-92	Stout	Rear	○ ○
M8038	WILLYS	66-79	CJ5, CJ6 & CJ7 Jeep	Rear	○ ○
M8039	TOYOTA	72-86	Landcruiser 40 series LDV leaf springs	Front	○ ○
M8039	WILLYS	45 - 62	CJ2, CJ3 Jeep	Front	○ ○
M8039	WILLYS	66-79	CJ5, CJ6 & CJ7 Jeep	Front	○ ○
M8039	WILLYS	45 - 62	CJ2, CJ3 Jeep	Rear	○ ○
M8041	VOLKSWAGEN	80-03	Kombi, Panelvan, Microbus, Caravelle & Transporter Type III (incl Syncro 4x4, & Front engined T4)	Front	⊗ ⊖
M8042	TOYOTA	79-84	HiLux 4x4 N30, N40)	Rear	○ ○
M8043	FORD	85-98	Husky Minibus, LDV, Panelvan	Front	⊥ ⊖
M8043	MITSUBISHI	83-04	L300 LDV (incl minibus)	Front	⊥ ⊖
M8043	MITSUBISHI	82-04	L300 Van & Minibus (incl LDV)	Front	⊥ ⊖
M8046	ISUZU	89-June'04	KB 4x2 std height (incl raised body & KB320) TF Series	Front	⊥ ⊖
M8046	LADA	FM_M00G	Niva 4x4	Front	⊥ ⊖
M8046	NISSAN	88- mid 99	1 Tonner 4x2 (AW) (incl Hardbody,Hi Rider, Sani, D/Cab & Diesel (GD21)	Front	⊥ ⊖
M8046	NISSAN	Mid 99-07	Hardbody 4x2 (QW) LDV (incl Hi-Rider) D22	Front	⊥ ⊖
M8046	NISSAN	08-21	NP300 4x2 LDV (incl Hi-Rider) (D22)	Front	⊥ ⊖
M8046	NISSAN	88-00	Sani Wagon 4x2	Front	⊥ ⊖
M8046	TOYOTA	84-93	Hi-Ace SWB Minibus (H50)	Front	⊥ ⊖
M8046	TOYOTA	85-93	Hi-Ace LWB 16 Seater Minibus / Taxi (H50)	Front	⊥ ⊖
M8046	TOYOTA	84-88	Hi-Ace SWB Panelvan	Front	⊥ ⊖
M8046	TOYOTA	85-93	Hi-Ace LWB Panelvan	Front	⊥ ⊖
M8047	HYUNDAI	96-on	H100 Bakkie Dropside LDV gen 3 & 4	Front	⊥ ⊖
M8047	JinBei	15-on	H2L minibus taxi	Front	⊥ ⊖
M8047	NISSAN	81-95	E20 van & Minibus	Front	⊥ ⊖
M8047	TOYOTA	19-on	Hi-Ace Ses'fikile 16 seater taxi & 14 Seater minibus (gen 5 H200)	Front	⊥ ⊖
M8047	TOYOTA	05 - 19	Quantum 2.5,D, 2.7 Van & Minibus (incl Ses'fikile taxi (gen 5 Hi-Ace H200) - For the newer 19-on model see Hi-Ace	Front	⊥ ⊖
M8048	FOTON	09-14	Inkunzi 2.2, 15 seater minibus taxi (LWB)	Rear	○ ○
M8048	FOTON	09-12	View panelvan (SWB)	Rear	○ ○
M8048	MAHINDRA	05-15	Scorpio 4x2 & 4x4 SUV (S10) gen 1 (Check mountings for correct applications)	Rear	○ ○

Key

*	See important installation information on inside front cover
!	Excluding self-levelling suspension
"..."	Special order - phone 010 900 1850. 6-12 week waiting period

~	Imported
#	Internal bump stop
⊖	Steering damper

- It is recommended that all new shock absorbers are fitted in pairs
- Do not mix gas and non-gas units on the same axle
- **Bold** part numbers indicate heavy-duty shocks
- Underlined part numbers indicate parts not immediately available
- *Italic* part numbers followed by > indicate parts to be discontinued

Passenger and light commercial

Part number [numerical listing]

Part number	Make	Year	Application	Position	Mounting information
M8048	TOYOTA	85-10	Hi-Ace SWB + LWB 16 Seater Minibus, Super 16 & Siyaya Taxi (H50)	Rear	○ ○
M8048	TOYOTA	85-10	Hi-Ace LWB Panelvan	Rear	○ ○
M8051	NISSAN	88- mid 99	1 Tonner 4x4 (AW) MC Hardbody, Sani, D/Cab & Diesel (MD21) ^ Twin shock (Additional double shock coilover unit)	Front	⊥ ⊕
M8051	NISSAN	88-00	Sani Wagon 4x4 ^ Twin shock (Additional double shock coilover unit)	Front	⊥ ⊕
M8052	mitsubishi	End 98-08	L200 Colt LDV 4x4 MC Rodeo & Pioneer 4x2 raised height & Clubcab	Rear	○ ○
M8055	TOYOTA	June'05-Jan 16	HiLux / Vigo "D4D" 4x4 & Raised body 4x2, gen 7 (AN10, AN20, AN30) Standard height	Front	⊥ ⊕
M8056	FOTON	15-16	Toplander SUV (U201)	Rear	○ ○
M8056	FOTON	12-22	Tunland 2.8 4x2 & 4x4 pick up	Rear	○ ○
M8056	TOYOTA	June'05-Jan 16	HiLux / Vigo "D4D" 4x4 & Raised body 4x2, gen 7 (AN10, AN20, AN30) Standard height	Rear	○ ○
M8058	FORD	86-Jan'00	Courier All 4X2	Front	⊥ ⊕
M8058	FORD	Feb'00-June'07	Ranger 4x2 (MC Hi-Trail)	Front	⊥ ⊕
M8058	GWM	08-on	Steed 5 & 5E 4x2 & 4x4 LDV ("Wingle" series)	Front	⊥ ⊕
M8058	JMC	10-16	Boarding Pick-up 4x2	Front	⊥ ⊕
M8058	MAZDA	86- 3/00	B Series Magnum All 4x2	Front	⊥ ⊕
M8058	MAZDA	4/00-07	Drifter 4x2 std ht (MC Hi-Trail 4x2)	Front	⊥ ⊕
M8058	MAZDA	07-11	BT-50 4x2 std ht (MC Hi-Trail 4x2) gen 1 (UN)	Front	⊥ ⊕
M8059	FORD	86-Jan'00	Courier All 4X2	Rear	○ ○
M8059	FORD	Feb'00-June'07	Ranger 4x2 (MC Hi-Trail)	Rear	○ ○
M8059	MAHINDRA	05-15	Bolero 2.5 Td 4x2 Single & D/C LDV 4x2 (Check mountings for the correct application)	Rear	○ ○
M8059	MAHINDRA	05-15	Bolero 2.5 Td 4x4 Single & D/C LDV 4x4 (Check mountings for the correct application)	Rear	○ ○
M8059	MAHINDRA	06 -15	Scorpio Pick-Up Single & D/C 4x2 & 4x4 LDV gen 1	Rear	⊕ ○
M8059	MAZDA	86- 3/00	B Series Magnum All 4x2	Rear	○ ○
M8059	MAZDA	4/00-07	Drifter 4x2 std ht (MC Hi-Trail 4x2)	Rear	○ ○
M8059	mitsubishi	End 98-09	L200 Colt LDV 4x2 standard height	Rear	○ ○
M8059	mitsubishi	07-16	Triton LDV All 4x4 & 4x2 raised body Std height gen 4 (MN)	Rear	○ ○
M8059	NISSAN	88- mid 99	1 Tonner 4x2 & 4x4 (AW) MC Hardbody,Hi Rider, Sani, D/Cab & Diesel (GD21)	Rear	○ ○
M8059	NISSAN	Mid 99-07	Hardbody 4x2 (QW) LDV (MC Hi-Rider) D22	Rear	○ ○
M8059	NISSAN	08-21	NP300 4x2 LDV (MC Hi-Rider) (D22)	Rear	○ ○
M8059	NISSAN	88-00	Sani Wagon 4x2	Rear	○ ○
M8059	NISSAN	88-00	Sani Wagon 4x4	Rear	○ ○
M8060	MAHINDRA	05 -15	Scorpio 4x2 SUV (S10) gen 1 4x2 (Check mountings for correct applications)	Front	⊥ ⊕
M8060	MAHINDRA	end 15 - Jan '22	Scorpio 4x2 & 4x4 SUV (S11) gen 1 facelift	Front	⊥ ⊕
M8060	mitsubishi	95-End 98	L200 Colt 4X4	Front	⊥ ⊕
M8066	FOTON	15-16	Toplander SUV (U201)	Front	⊥ ⊕
M8066	FOTON	12-22	Tunland 2.8 4x2 & 4x4 pick up	Front	⊥ ⊕
M8066	TOYOTA	March 06-16	Fortuner SUV 3.0TD & 4.0 V6 4x4 and 4x2 High Rider gen 1 (AN50 / AN60)	Front	⊥ ⊕
M8067	TOYOTA	06 - '16	Fortuner SUV 3.0TD & 4.0 V6 4x4 and 4x2 High Rider gen 1 (AN50 / AN60)	Rear	⊥ ○
M8073	FORD	July'07-11	Ranger 4x2 (MC Hi-Trail)	Rear	⊕ ⊕
M8073	MAZDA	07-11	BT-50 4x2 std ht (MC Hi-Trail 4x2) gen 1 (UN)	Rear	○ ○
M8074	BAW / CAM	07-13	Inyati minibus Taxi	Rear	○ ○
M8074	GONOW	08-14	Inguni Minibus Taxi	Rear	○ ○
M8074	JinBei	15-on	H2L minibus taxi	Rear	○ ○

Key

*	See important installation information on inside front cover
!	Excluding self-leveling suspension
"..."	Special order - phone 010 900 1850. 6-12 week waiting period

~	Imported
#	Internal bump stop
⊕	Steering damper

- It is recommended that all new shock absorbers are fitted in pairs
- Do not mix gas and non-gas units on the same axle
- **Bold** part numbers indicate heavy-duty shocks
- Underlined part numbers indicate parts not immediately available
- *Italic* part numbers followed by > indicate parts to be discontinued

Passenger and light commercial

Part number [numerical listing]

Part number	Make	Year	Application	Position	Mounting information
M8074	TOYOTA	19-on	Hi-Ace Ses'fikile 16 seater taxi & 14 Seater minibus (gen 5 H200)	Rear	○ ○
M8074	TOYOTA	05 - 19	Quantum 2.5,D, 2.7 Van & Minibus INCL Ses'fikile taxi (gen 5 Hi-Ace H200) - For the newer 19-on model see Hi-Ace	Rear	○ ○
M8075	TOYOTA	95-98	RAV4 Type SXA 10 & 11 EXCL sealed struts & 235/60R 16" wheels) gen 1	Rear	⊥ ○
M8075	TOYOTA	98-00	RAV4 Type SXA 10 & 11 Sealed front struts EXCL 235/60R 16" wheels) gen 1	Rear	⊥ ○
M8075	TOYOTA	01- Feb'06	RAV4 (ACA20,21 / ZCA 25, 26 / XA20) gen 2	Rear	⊥ ○
M8077	TOYOTA	97-'02	Prado J90 series 3 door SWB S/W EXCL eye/eye rear mountings)	Front	⊥ ⊖
M8078	TOYOTA	97-'02	Prado J95 series 5 door LWB S/W EXCL eye/eye rear mountings)	Front	⊥ ⊖
M8078	TOYOTA	95-02	4-Runner & Surf Gen 3 (N180)	Front	⊥ ⊖
M8083	FORD	end 11-19	Ranger 4x2 EXCL Hi-Trail) T6	Front	⊥ ⊖
M8083	MAZDA	12-21	BT-50 4x2 std ht EXCL Hi-Trail 4x2) gen 2 (PN40, UP, UR)	Front	⊥ ⊖
M8085	FORD	end 11-19	Ranger 4x2 EXCL Hi-Trail) T6	Rear	⊖ ⊖
M8085	FORD	mid 19-22	Ranger 4x2 EXCL Hi-Trail) T6	Rear	⊖ ⊖
M8085	MAZDA	12-21	BT-50 4x2 std ht EXCL Hi-Trail 4x2) gen 2 (PN40, UP, UR)	Rear	⊖ ⊖
M8086	FORD	end 11-19	Ranger 4x4 & 4x2 Hi-Trail raised body T6 EXCL Raptor)	Front	⊥ ⊖
M8086	MAZDA	12-21	BT-50 4x4 & Hi-Trail 4x2 gen 2 (PN40, UP, UR) Std Ht	Front	⊥ ⊖
M8087	FORD	end 11-19	Ranger 4x4 & 4x2 Hi-Trail raised body T6 EXCL Raptor)	Rear	⊖ ⊖
M8087	FORD	mid 19-22	Ranger 4x4 & 4x2 Hi-Trail raised body T6 EXCL Raptor)	Rear	⊖ ⊖
M8087	MAZDA	12-21	BT-50 4x4 & Hi-Trail 4x2 gen 2 (PN40, UP, UR) Std Ht	Rear	⊖ ⊖
M8088	CHEVROLET	12-18	Trailblazer SUV 7 seater (RG)	Front	⊥ ○
M8088	ISUZU	April '13-'21	KB / D-Max 4X4 P190 / RT50 / RT85 & 4x2 Hi-Rider raised body RT series	Front	⊥ ○
M8089	ISUZU	April '13-'21	KB / D-Max 4X2 Std Height P190 / RT50 / RT85 EXCL Hi-Rider) RT series	Rear	○ ○
M8089	ISUZU	April '13-'21	KB / D-Max 4X4 P190 / RT50 / RT85 & 4x2 Hi-Rider raised body RT series	Rear	○ ○
M8089	MAHINDRA	05-15	Scorpio 4x2 & 4x4 SUV (S10) gen 1 (Check mountings for correct applications)	Rear	○ ○
M8095	ISUZU	April '13-'21	KB / D-Max 4X2 Std Height P190 / RT50 / RT85 EXCL Hi-Rider) RT series	Front	⊥ ○
M8096	TOYOTA	16-on	HiLux "Revo", "GD6" 4x4 & Raised body 4x2, gen 8, EXCL GR Sport (N120, N130) Std height	Front	⊥ ⊖
M8097	TOYOTA	16-on	HiLux "Revo", "GD6" 4x4 & Raised body 4x2, gen 8, EXCL GR Sport (N120, N130) Std height	Rear	○ ○
M8099	FORD	mid 19-22	Ranger 4x2 EXCL Hi-Trail) T6	Front	⊥ ⊖
M8101	FORD	mid 19-22	Ranger 4x4 & 4x2 Hi-Trail raised body T6 EXCL Raptor)	Front	⊥ ⊖
M8352	TOYOTA	April 16 - on	Fortuner SUV 2.4GD, 2.7, 2.8GD, 3.0TD & 4.0 V6 4x4 and 4x2 High Rider gen 2 (AN150/AN160) Std height	Front	⊥ ⊖
M8353	TOYOTA	April 16 - on	Fortuner SUV 2.4GD, 2.7, 2.8GD, 3.0TD & 4.0 V6 4x4 and 4x2 High Rider gen 2 (AN150/AN160) Std height	Rear	⊥ ○
M8354	NISSAN	14-on	NV350 panel van & 16 seater "Impendulo" minibus taxi 2.5 (E26)	Front	⊥ ⊖
M8355	NISSAN	14-on	NV350 panel van & 16 seater "Impendulo" minibus taxi 2.5 (E26)	Rear	○ ⊖
M8356	MERCEDES-BENZ	17-21	X-class LCV (Check rear suspension type before selection)	Front	⊥ ⊖
M8356	NISSAN	April 17-on	Navara 4x2 Raised body & 4x4 LDV (D23) EXCL '21 facelift Std height	Front	⊥ ⊖
M8357	MERCEDES-BENZ	17-21	X-class LCV (for 5 link coil susp) Top mtng 16mm, btm 14mm ID	Rear	○ ⊖
M8357	NISSAN	April 17-on	Navara 4x2 Raised body & 4x4 LDV (D23) EXCL '21 facelift (5 link coil susp) Std height	Rear	○ ⊖
M8358	MERCEDES-BENZ	17-21	X-class LCV (for leaf susp) top & btm mtng both 16mm ID	Rear	○ ○
M8358	NISSAN	April 17-on	Navara 4x2 Raised body & 4x4 LDV (D23) EXCL '21 facelift (leaf spring susp) Std height	Rear	○ ⊖
<i>MG308</i> >	BMW	88-95	5 Series (E34) EXCL Sport Susp, M Tech & M5) (12mm rod OD & long "neck")	Front	⌋
MG318	BMW	88-95	5 Series (E34) EXCL Sport Susp, M Tech & M5) (12mm rod OD & short "neck")	Front	⌋
MR315	AUDI	77-83	100, 200	Front	⌋

Key









































*	See important installation information on inside front cover
!	Excluding self-levelling suspension
"..."	Special order - phone 010 900 1850. 6-12 week waiting period

~	Imported
#	Internal bump stop
⊖	Steering damper

- It is recommended that all new shock absorbers are fitted in pairs
- Do not mix gas and non-gas units on the same axle
- **Bold** part numbers indicate heavy-duty shocks
- Underlined part numbers indicate parts not immediately available
- *Italic* part numbers followed by > indicate parts to be discontinued

Passenger and light commercial

Part number [numerical listing]

Part number	Make	Year	Application	Position	Mounting information
MR315	AUDI	83-94	400, 500 (301) Quattro, sport susp & S4)	Front	
MR315	AUDI	91-94	500 Quattro sedan and Avant S/W std susp (301) S4 & sport susp)	Front	
MR315	AUDI	91-94	500 Quattro sport suspension sedan and Avant S/W (301) S4)	Front	
MR315	AUDI	91-94	S4 2.2 (301) 4.2 & sports susp)	Front	
MR315	AUDI	94-July'97	A6 Sedan & Avant (301) Quattro, Sport susp., & S6)	Front	
MR315	AUDI	94-July'97	A6 Sedan & Avant Quattro (301) Sport suspension & S6)	Front	
MR315	AUDI	94-July'97	A6 & S6 4.2 Sedan & Avant Quattro Sport suspension (301) S6)	Front	
R1643 (oil shock)	CHEVROLET	08-on	QQ3 (S11) 0.8, 1.1	Rear	
R1643 (oil shock)	CHEVROLET	03-05	Spark (M100, M150)	Rear	
R1643 (oil shock)	DAEWOO	99-03	Matiz hatch M100	Rear	
R2644 > (oil shock)	FORD	Mid 83-93	  Sierra & Sapphire Sedan (301) XR8 & S/W	Rear	
R2716 > (oil shock)	LAND ROVER	54-83	86", 88" & 107" SWB (Series I, II, IIA, IIB & III) Steering Damper ⊕	Front	
R2716 > (oil shock)	LAND ROVER	58-84	109" & 119" LWB (301) S/Wagon) Series II, IIA, IIB&III Steering Damper ⊕	Front	
R2716 > (oil shock)	LAND ROVER	89-94	Discovery I Steering Damper ⊕	Front	
R2716 > (oil shock)	LAND ROVER	95-98	Discovery I Steering Damper ⊕	Front	
R2716 > (oil shock)	LAND ROVER	76-96	Range Rover Classic gen 1 (301) Air Susp.) Steering Damper ⊕	Front	
R2716 > (oil shock)	LAND ROVER	92-96	Range Rover Classic gen 1 Air Susp Steering Damper ⊕	Front	
R7001 (R) ~ R7002 (L) ~ (oil shock)	HYUNDAI	July 00-05	 Accent II (LC)	Rear	
R7001 (R) ~ R7002 (L) ~ (oil shock)		June'97-June'00	 Accent I (X3) facelift (Larger rear springpan than earlier model)	Rear	
R7101 (R) R7102 (L) (oil shock)	HYUNDAI	94-May'97	 Accent I (X3)	Front	
R7101 (R) R7102 (L) (oil shock)	HYUNDAI	June'97-June'00	 Accent I (X3) facelift (Larger rear springpan than earlier model)	Front	
R7213 (R) R7214 (L) (oil shock)	CHEVROLET	03-11	Aveo gen one & two (T200 & T250 facelift)	Front	
R7613 (R) R7614 (L) (oil shock)	HYUNDAI	03-11	Getz (TB)	Front	
R8001 (R) R8002 (L) (oil shock)	CITROEN	96-02	Berlingo Multispace MPV & P/Van	Front	
R8001 (R) R8002 (L) (oil shock)	PEUGEOT	99-Nov'02	Partner Grand Raid MPV 2.0 Hdi (DW10TD) gen 1 (600kg payload) (5F)	Front	
R8001 (R) R8002 (L) (oil shock)	PEUGEOT	99-11/02	Partner Panel Van 1.9D gen 1 (800kg payload)	Front	
RS55020	FORD	end 11-19	Ranger 4x4 & 4x2 Hi-Trail raised body T6 (301) Raptor)	Rear	
RS55020	FORD	mid 19-22	Ranger 4x4 & 4x2 Hi-Trail raised body T6 (301) Raptor)	Rear	
RS55020	MAZDA	12-21	BT-50 4x4 & Hi-Trail 4x2 gen 2 (PN40, UP, UR) Std Ht	Rear	
RS55020A	FORD	end 11-19	Ranger 4x4 & 4x2 Hi-Trail raised body T6 (301) Raptor) Raised 38mm	Rear	
RS55020A	FORD	mid 19-22	Ranger 4x4 & 4x2 Hi-Trail raised body T6 (301) Raptor) Raised 38mm	Rear	
RS55020A	MAZDA	12-21	BT-50 4x4 & Hi-Trail 4x2 gen 2 (PN40, UP, UR) Raised 38mm	Rear	
RS55021D	ISUZU	April '13-'21	KB / D-Max 4X4 P190 / RT50 / RT85 & 4x2 Hi-Rider raised body RT series	Rear	
RS55118C >	MITSUBISHI	17-24	Triton LDV All 4x4 & 4x2 raised body Std height gen 5 (MQ) (301) 2019 facelift (KJ/KK/KL) Raised +-30mm	Rear	
RS55143E	TOYOTA	16-on	HiLux "Revo", "GD6" 4x4 & Raised body 4x2, gen 8, (301) GR Sport (N120, N130) Raised +-40mm	Rear	

Key

*	See important installation information on inside front cover
!	Excluding self-levelling suspension
"..."	Special order - phone 010 900 1850. 6-12 week waiting period

~	Imported
#	Internal bump stop
⊕	Steering damper

- It is recommended that all new shock absorbers are fitted in pairs
- Do not mix gas and non-gas units on the same axle
- **Bold** part numbers indicate heavy-duty shocks
- Underlined part numbers indicate parts not immediately available
- *Italic* part numbers followed by > indicate parts to be discontinued

Passenger and light commercial

Part number [numerical listing]

Part number	Make	Year	Application	Position	Mounting information
RS55188	NISSAN	Mid 99-07	Hardbody 4x4 & 4x2 Hi-Rider D/C (QW) LDV D22	Front	⊥ ⊕
RS55188	NISSAN	08-21	NP300 4x4 & 4x2 Hi-Rider D/C LDV (D22)	Front	⊥ ⊕
RS55188 >	NISSAN	88- mid 99	1 Tonner 4x4 (AW) MC Hardbody, Sani, D/Cab & Diesel (MD21)	Front	⊥ ⊕
<i>RS55188 ></i>	NISSAN	82-88	Sani Wagon 4x4	Front	⊥ ⊕
<i>RS55188 ></i>	NISSAN	88-00	Sani Wagon 4x4	Front	⊥ ⊕
RS55194A	NISSAN	April 17-on	Navara 4x2 Raised body & 4x4 LDV (D23) MC '21 facelift (5 link coil susp) Std height	Rear	○ ⊕
RS55194A	MERCEDES-BENZ	17-21	X-class LCV (for 5 link coil susp) Top mtng 16mm, btm 14mm ID	Rear	○ ⊕
RS55264B	NISSAN	April 17-on	Navara 4x2 Raised body & 4x4 LDV (D23) MC '21 facelift (5 link coil susp) Raised +-30mm	Rear	○ ⊕
RS55355A	TOYOTA	16-on	HiLux "Revo", "GD6" 4x4 & Raised body 4x2, gen 8, GR Sport (N120, N130) Std height	Rear	○ ○
RS55357B	TOYOTA	Nov '09-01 '24	Prado J150 GR elec susp) 3.0 GRJ150, 4.0 KDJ150 Std Height	Rear	⊥ ○
RS55357C	TOYOTA	April 16 - on	Fortuner SUV 2.4GD, 2.7, 2.8GD, 3.0TD & 4.0 V6 4x4 and 4x2 High Rider gen 2 (AN150/AN160) Std height	Rear	⊥ ○
RS55357D	TOYOTA	April 16 - on	Fortuner SUV 4x4 and 4x2 High Rider gen 2 (AN150/AN160) Raised +-40mm	Rear	⊥ ○
<i>RS55365A ></i>	MITSUBISHI	99-April '07	Pajero 4x4 gen3 K94W, K96W, V64W, V65W, V68W, V74W, V75W & V78W (NM, NP) GR elec susp) Check OE #'s Raised +-35mm	Rear	⊥ ⊕
<i>RS55365A ></i>	MITSUBISHI	May'07-21	Pajero 4x4 gen 4 V80 (NT / NW) Raised +-35mm	Rear	⊥ ⊕
<u>RS55752</u>	FORD	mid 19-22	Ranger 4x4 & 4x2 Hi-Trail raised body T6 EX Raptor	Front	⊥ ⊕
<u>RS55752B</u>	FORD	mid 19-22	Ranger 4x4 & 4x2 Hi-Trail raised body T6 EX Raptor Raised	Front	⊥ ⊕
RS55778B	MAZDA	12-21	BT-50 4x4 & Hi-Trail 4x2 gen 2 (PN40, UP, UR) Raised 38mm	Front	⊥ ⊕
RS55778B	FORD	end 11-19	Ranger 4x4 & 4x2 Hi-Trail raised body T6 EX Raptor Raised	Front	⊥ ⊕
<u>RS55779A</u>	ISUZU	April '13-'21	KB / D-Max 4X4 P190 / RT50 / RT85 & 4x2 Hi-Rider raised body RT series	Front	⊥ ○
RS55783A	TOYOTA	Nov '09-01 '24	Prado J150 GR elec susp) 3.0 GRJ150, 4.0 KDJ150 Std Height	Front	⊥ ⊕
RS55783D	TOYOTA	April 16 - on	Fortuner SUV 2.4GD, 2.7, 2.8GD, 3.0TD & 4.0 V6 4x4 and 4x2 High Rider gen 2 (AN150/AN160) Std height	Front	⊥ ⊕
RS55783D	TOYOTA	16-on	HiLux "Revo", "GD6" 4x4 & Raised body 4x2, gen 8, GR Sport (N120, N130) Std height	Front	⊥ ⊕
RS55783F	TOYOTA	April 16 - on	Fortuner SUV 2.4 Raised +-40mm	Front	⊥ ⊕
RS55783F	TOYOTA	16-on	HiLux "Revo", "GD6" 4x4 & Raised body 4x2, gen 8, GR Sport (N120, N130) Raised +-40mm	Front	⊥ ⊕
RS55787B	NISSAN	05-March 17	Navara 4x2 & 4x4 2.5 dCi, 3.0, 4.0 V6 LDV (D40) Std height	Front	⊥ ⊕
RS55787B	NISSAN	05 - 15	Pathfinder 4x4 SUV (R51)	Front	⊥ ⊕
RS55787D	NISSAN	April 17-on	Navara Raised +-30mm 4x2 Raised body & 4x4 LDV (D23) MC '21 facelift	Front	⊥ ⊕
RS55787E	MERCEDES-BENZ	17-21	X-class LCV (Check rear suspension type before selection)	Front	⊥ ⊕
RS55787E	NISSAN	April 17-on	Navara 4x2 Raised body & 4x4 LDV (D23) MC '21 facelift Std height	Front	⊥ ⊕
RS55801B	FIAT	16-on	Fiat Fullback LCV ALL 4x2 raised body & 4x4	Front	⊥ ⊕
RS55801B	MITSUBISHI	Sept '17-on	Pajero Sport SUV 2,4 gen 3 (KR/KS/QE + QF facelift)	Front	⊥ ⊕
RS55801B	MITSUBISHI	17-24	Triton LDV All 4x4 & 4x2 raised body Std height gen 5 (MQ) MC 2019 facelift (KJ/KK/KL)	Front	⊥ ⊕
RS55802A	MITSUBISHI	99-April '07	Pajero 4x4 gen3 (Raised +-38mm) K94W, K96W, V64W, V65W, V68W, V74W, V75W & V78W (NM, NP) GR elec susp) Check OE #'s Raised	Front	⊥ ⊕
RS55802A	MITSUBISHI	May'07-21	Pajero 4x4 gen 4 V80 (NT / NW) Raised +-35mm	Front	⊥ ⊕
<i>RS999010 ></i>	MITSUBISHI	End 98-08	L200 Colt LDV 4x4 MC Rodeo & Pioneer 4x2 raised height & Clubcab	Rear	○ ○
RS999039	FORD	86-Jan'00	Courier All 4X4	Front	⊥ ⊕
RS999039	FORD	09-Sept '15	Everest SUV 4x2 & 4x4 (U268)	Front	⊥ ⊕
RS999039	FORD	Feb'00-June'07	Ranger 4x4 & 4x2 Hi-Trail raised body	Front	⊥ ⊕
RS999039	FORD	July'07-11	Ranger 4x4 & 4x2 Hi-Trail raised body	Front	⊥ ⊕
RS999039	MAZDA	86- 3/00	B Series Magnum All 4x4	Front	⊥ ⊕
RS999039	MAZDA	4/00-07	Drifter 4x4 & Hi-Trail 4x2	Front	⊥ ⊕

Key

*	See important installation information on inside front cover
!	Excluding self-leveling suspension
...	Special order - phone 010 900 1850. 6-12 week waiting period

~	Imported
#	Internal bump stop
⊕	Steering damper

- It is recommended that all new shock absorbers are fitted in pairs
- Do not mix gas and non-gas units on the same axle
- **Bold** part numbers indicate heavy-duty shocks
- Underlined part numbers indicate parts not immediately available
- *Italic* part numbers followed by > indicate parts to be discontinued

Passenger and light commercial

Part number [numerical listing]

Part number	Make	Year	Application	Position	Mounting information
RS999039	MAZDA	07-11	BT-50 4x4 & Hi-Trail 4x2 gen 1 (UN)	Front	⊥ ⊕
RS999039	TATA	04 -16	Telcoline 2.0 4x2 & 4x4 LDV (MC) 3.0 Diesel Worker	Front	⊥ ⊕
RS999039	TATA	07-19	Xenon 4x2 & 4x4 LDV (excludes models with front top eye mountings)	Front	⊥ ⊕
RS999063	JEEP	22-on	Jeep Gladiator pickup (LN) Std Height	Front	⊕ ⊕
RS999063	JEEP	18-on	Jeep Wrangler (JL series) Std Height	Front	⊕ ⊕
RS999064	JEEP	18-on	Jeep Wrangler (JL series) Std Height	Rear	⊕ ⊕
RS999113	JEEP	86- 96	Jeep Wrangler 4x4 (YJ series) Std Height	Rear	○ ⊕
RS999113	MITSUBISHI	07-16	Triton LDV All 4x4 & 4x2 raised body Std height gen 4 (MN)	Rear	○ ○
RS999113	NISSAN	88- mid 99	1 Tonneer 4x2 & 4x4 (AW) (MC) Hardbody,Hi Rider, Sani, D/Cab & Diesel (GD21)	Rear	○ ○
RS999113	NISSAN	Mid 99-07	Hardbody 4x2 (QW) LDV (MC) Hi-Rider) D22	Rear	○ ○
RS999113	NISSAN	08-21	NP300 4x2 LDV (MC) Hi-Rider) (D22)	Rear	○ ○
RS999113	NISSAN	88-00	Sani Wagon 4x4	Rear	○ ○
RS999116	ISUZU	Mid 81-89	KB21, KB23, KB28, KBD22, KBD27 4X2	Rear	○ ○
RS999116	ISUZU	Mid 81-89	KB41, KB43, KBD42 4x4	Rear	○ ○
RS999116	ISUZU	89-June'04	KB 4x2 std height (MC) raised body & KB320) TF Series	Rear	○ ○
RS999116	ISUZU	89-June'04	KB 4x4 & Raised body 4x2 (MC) all KB320) TF Series	Rear	○ ○
RS999116	ISUZU	July'04-March '13	KB 4X4 P190 & 4x2 Hi-Rider raised body RA / RC series Raised 40mm	Rear	○ ○
RS999116	MITSUBISHI	95-End 98	L200 Colt 4X4	Rear	○ ○
RS999116	TATA	04 -16	Telcoline 2.0 4x2 & 4x4 LDV (MC) 3.0 Diesel Worker	Rear	○ ○
RS999116	TATA	07-19	Xenon 4x2 & 4x4 LDV (excludes models with front top eye mountings)	Rear	○ ○
RS999116	TOYOTA	79-84	Hilux 4x4 N30, N40)	Rear	○ ○
RS999116	TOYOTA	72-86	Landcruiser 40 series LDV leaf springs (48mm longer than OE)	Rear	○ ○
RS999128	JEEP	93- 98	Jeep Grand Cherokee All (ZJ series) (MC) Up- country Susp) Std Height	Front	⊥ ⊕
RS999128	JEEP	99-5/05	Jeep Grand Cherokee All (WJ series) (MC) Up country susp) Std Height	Front	⊥ ⊕
RS999128	JEEP	97-06	Jeep Wrangler 4x4 (TJ series) (MC) Sport (MC) Rubicon) Std Height	Front	⊥ ⊕
RS999128	JEEP	91- 01	Jeep Cherokee 4x4 (MC) Sport, Limited & Country (XJ) Std ht	Front	⊥ ⊕
RS999136	ISUZU	July'04-March '13	KB 4X4 P190 & 4x2 Hi-Rider raised body RA / RC series Raised 40mm to 70mm	Front	⊥ ○
RS999136	TOYOTA	79-84	Hilux 4x4 N30, N40)	Front	⊥ ⊕
RS999136	TOYOTA	84-End'98	Hilux All 4x4 (N505, N60) Standard susp	Front	⊥ ⊕
RS999136	TOYOTA	End 98-May'05	Hilux P690 All 4x4 & raised body 4x2 (MC) Raider IFS gen 6 Raised +-60mm	Front	⊥ ⊕
RS999143	TOYOTA	End 98-May'05	Hilux P690 All 4x4 & raised body 4x2 (MC) Raider IFS gen 6 Raised +-40mm	Rear	○ ○
RS999143	TOYOTA	07-on	Landcruiser 76 & 78 series S/Wagon (Coil front, leaf rear) Raised +-50mm	Rear	○ ○
RS999143	TOYOTA	99-on	Landcruiser HZJ79 series LDV Rear leaf springs, Coil front Raised +-50mm	Rear	○ ○
RS999144	FOTON	15-16	Toplander SUV (U201)	Rear	○ ○
RS999144	FOTON	12-22	Tunland 2.8 4x2 & 4x4 pick up	Rear	○ ○
RS999144	TOYOTA	84-End'98	Hilux All 4x4 (N505, N60) Standard susp	Rear	○ ○
RS999144	TOYOTA	End 98-May'05	Hilux P690 All 4x4 & raised body 4x2 (MC) Raider IFS gen 6 (N140, N150, N160, N170)	Rear	○ ○
RS999144	TOYOTA	June'05-Jan 16	Hilux / Vigo "D4D" 4x4 & Raised body 4x2, gen 7 (AN10, AN20, AN30) Standard height	Rear	○ ○
RS999145	TOYOTA	End 98-May'05	Hilux P690 All 4x4 & raised body 4x2 (MC) Raider IFS gen 6 (N140, N150, N160, N170)	Front	⊥ ⊕
RS999187	TOYOTA	97-'02	Prado J90 series 3 door SWB S/W (MC) eye/eye rear mountings)	Rear	⊥ ○
RS999187	TOYOTA	97-'02	Prado J95 series 5 door LWB S/W (MC) eye/eye rear mountings)	Rear	⊥ ○
RS999201 >	NISSAN	89- 97	Patrol S/W 4x4 G0 / GR Y60 Series (Coil springs) 10mm OD studs	Front	⊥ T

Key

*	See important installation information on inside front cover
!	Excluding self-levelling suspension
"..."	Special order - phone 010 900 1850. 6-12 week waiting period

~	Imported
#	Internal bump stop
⊕	Steering damper

- It is recommended that all new shock absorbers are fitted in pairs
- Do not mix gas and non-gas units on the same axle
- **Bold** part numbers indicate heavy-duty shocks
- Underlined part numbers indicate parts not immediately available
- *Italic* part numbers followed by > indicate parts to be discontinued

Passenger and light commercial

Part number [numerical listing]

Part number	Make	Year	Application	Position	Mounting information
RS999202	NISSAN	89- 97	Patrol S/W 4x4 G0 / GR Y60 Series (Coil springs) 19mm ID mounting holes	Rear	○ ○
RS999202	NISSAN	98-17	Patrol S/W 4x4 GR I / GU I Y61 Series (Coil springs) [M] '02-on 3.0TDi & 4.8i GR II / GU II series Std height Mounting sizes Top 19.5id hole / Btm 19.2 id hole	Rear	○ ⊕
RS999202	TOYOTA	June 05-Jan 16	HiLux / Vigo "D4D" 4x4 & Raised body 4x2, gen 7 Raised +-50mm	Rear	○ ○
RS999202	TOYOTA	07-on	Landcruiser 76 & 78 series S/Wagon (Coil front, leaf rear) Std Susp	Rear	○ ○
RS999202	TOYOTA	87- 99	Landcruiser HZJ75 series LDV leaf springs Standard Susp	Rear	○ ○
RS999202	TOYOTA	99-on	Landcruiser HZJ79 series LDV Rear leaf springs, Coil front Std Susp	Rear	○ ○
RS999207	LAND ROVER	92-96	Range Rover Classic gen 1 Air Susp	Front	⊥ T
RS999207	TOYOTA	07-on	Landcruiser 76 & 78 series S/Wagon (Coil front, leaf rear) Raised +-70mm	Front	⊥ T
RS999207	TOYOTA	90-98	Landcruiser 80 series S/Wagon [M] certain solid axle 105 series '98-'07 models) All Standard Susp	Front	⊥ T
RS999207	TOYOTA	99-on	Landcruiser HZJ79 series LDV Rear leaf springs, Coil front Raised +-70mm	Front	⊥ T
RS999208	TOYOTA	90-98	Landcruiser 80 series S/Wagon [M] certain solid axle 105 series '98-'07 models) All Standard Susp	Rear	⊥ ⊕
RS999208	TOYOTA	95-02	4-Runner & Surf Gen 3 (N180)	Rear	⊥ ⊕
RS999213 >	MITSUBISHI	91- 99	Pajero 4x4 gen 2 V Series: V21, V24, V41, V44, V46 coil rear (NH, NJ, NK, NL) [S] elec susp)	Rear	⊥ ⊕
RS999214	ISUZU	98-mid 03	Frontier Wagon, All 4x2 and 4X4 [M] facelift)	Front	⊥ ⊕
RS999214	ISUZU	89-June'04	KB 4x4 & Raised body 4x2 [M] all KB320) TF Series	Front	⊥ ⊕
RS999214	ISUZU	July'04-March '13	KB 4X4 P190 & 4x2 Hi-Rider raised body RA / RC series Std height Torsion bars	Front	⊥ ○
RS999214	ISUZU	87-91	Trooper UBS 12/52 series	Front	⊥ ⊕
RS999214	ISUZU	92-02	Trooper UBS 69 series	Front	⊥ ⊕
RS999214	ISUZU	97-02	Trooper UBS 26/73 series	Front	⊥ ⊕
RS999223 >	MITSUBISHI	91- 99	Pajero 4x4 gen 2 V Series: V21, V24, V41, V44, V46 coil rear (NH, NJ, NK, NL) [S] elec susp)	Front	⊥ ⊕
RS999239	JEEP	91- 01	Jeep Cherokee 4x4 [M] Sport, Limited & Country (XJ) v RAISED – 63.5mm (2.5") Lift	Front	⊥ ⊕
RS999239	JEEP	93- 98	Jeep Grand Cherokee All (ZJ series) (raised 76mm)	Front	⊥ ⊕
RS999239	JEEP	99-5/05	Jeep Grand Cherokee All (WJ series) (50mm longer)	Front	⊥ ⊕
RS999239	JEEP	97-06	Jeep Wrangler 4x4 (TJ series) [M] Sport Raised 63mm	Front	⊥ ⊕
RS999240 >	JEEP	97-06	Jeep Wrangler 4x4 (TJ series) [M] Sport [S] Rubicon) Std Height	Rear	⊕ ⊕
RS999241	JEEP	97-06	Jeep Wrangler 4x4 (TJ series) [M] Sport Raised 63mm	Rear	⊕ ⊕
RS999254 >	FORD	05-09	F250 (4x4) (check front mountings)	Rear	○ ⊕
RS999284 >	JEEP	02-07	Jeep Cherokee 4x4 (KJ)	Rear	⊕ ⊕
RS999284 >	JEEP	08-13	Jeep Cherokee 4x4 (KK)	Rear	⊕ ⊕
RS999284 >	JEEP	99-5/05	Jeep Grand Cherokee All (WJ series) [M] Up country susp) Raised 45mm	Rear	⊕ ⊕
RS999305	TOYOTA	11-on	FJ Cruiser	Rear	⊥ ○
RS999305	TOYOTA	09-on	4-Runner & Surf Gen 5 GN5 (N280) [S] KDSS susp)	Rear	⊥ ⊕
RS999307	HUMMER	05-11	H3 Std height	Front	⊥ T
RS999308	HUMMER	05-11	H3 – Std height	Rear	⊕ ⊕
RS999309 >	HUMMER	05-11	H3 Raised 100mm	Front	⊥ T
RS999310 >	HUMMER	05-11	H3 – Raised 100mm	Rear	⊕ ⊕
RS999311	NISSAN	05-March 17	Navara 4x2 & 4x4 2.5 dCi, 3.0, 4.0 V6 LDV (D40) Std height	Rear	○ ⊕
RS999311	NISSAN	05-March 17	Navara 4x2 & 4x4 2.5 dCi, 3.0, 4.0 V6 LDV (D40) Raised +-30mm	Rear	○ ⊕
RS999312 >	NISSAN	05 – 15	Pathfinder 4x4 SUV (R51)	Rear	⊕ ⊕
RS999321	FORD	86-Jan'00	Courier All 4X4	Rear	⊕ ⊕
RS999321	FORD	09-Sept '15	Everest SUV 4x2 & 4x4 (U268)	Rear	⊕ ⊕
RS999321	FORD	Feb'00-June'07	Ranger 4x4 & 4x2 Hi-Trail raised body	Rear	⊕ ⊕

Key

*	See important installation information on inside front cover
!	Excluding self-levelling suspension
"..."	Special order – phone 010 900 1850. 6-12 week waiting period

~	Imported
#	Internal bump stop
⊕	Steering damper

- It is recommended that all new shock absorbers are fitted in pairs
- Do not mix gas and non-gas units on the same axle
- **Bold** part numbers indicate heavy-duty shocks
- Underlined part numbers indicate parts not immediately available
- *Italic* part numbers followed by > indicate parts to be discontinued

Passenger and light commercial

Part number [numerical listing]

Part number	Make	Year	Application	Position	Mounting information
RS999321	FORD	July'07-11	Ranger 4x4 & 4x2 Hi-Trail raised body	Rear	⊖ ⊖
RS999321	MAZDA	86- 3/00	B Series Magnum All 4x4	Rear	⊖ ⊖
RS999321	MAZDA	4/00-07	Drifter 4x4 & Hi-Trail 4x2	Rear	⊖ ⊖
RS999321	MAZDA	07-11	BT-50 4x4 & Hi-Trail 4x2 gen 1 (UN)	Rear	⊖ ⊖
RS999326	JEEP	07-18	Jeep Wrangler 4x4 (JK series) 2 & 4 door Raised 50mm	Front	⊥ ⊖
RS999326	JEEP	07-18	Jeep Wrangler 4x4 (JK series) 2 & 4 door MC Rubicon & Unlimited Std Height	Front	⊥ ⊖
RS999328	JEEP	07-18	Jeep Wrangler 4x4 (JK series) 2 & 4 door MC Rubicon & Unlimited Std Height	Rear	⊖ ⊖
RS999339	LAND ROVER	76-96	Range Rover Classic gen 1 (EXC Air Susp.)	Front	⊥ T
RS999339	LAND ROVER	84-16	90, 110 Defender SW & 130" Double Cab LDV (L316 & L317)	Front	⊥ T
RS999339	LAND ROVER	95-98	Discovery I	Front	⊥ T
RS999340	LAND ROVER	84-16	90, 110 Defender SW & 130" Double Cab LDV (L316 & L317)	Rear	⊖ T
RS999340	LAND ROVER	89-94	Discovery I	Rear	⊖ T
RS999340	LAND ROVER	95-98	Discovery I	Rear	⊖ T
RS999340	LAND ROVER	76-96	Range Rover Classic gen 1 (EXC Air Susp.)	Rear	⊖ T
RS999341	ISUZU	July'04-March '13	KB 4X4 P190 & 4x2 Hi-Rider raised body RA / RC series Std height	Rear	○ ○
RS999341	NISSAN	Mid 99-07	Hardbody 4x4 & 4x2 Hi-Rider D/C (QW) LDV D22	Rear	○ ○
RS999341	NISSAN	08-21	NP300 4x4 & 4x2 Hi-Rider D/C LDV (D22)	Rear	○ ○
RS999341	NISSAN	82-88	Sani Wagon 4x4	Rear	○ ○
RS999341	TOYOTA	83-89	Landcruiser 60 series S/Wagon Models #J6##V-... (FJ60, FJ62, HJ60, HJ6) Std Susp	Rear	○ ○
RS999341	TOYOTA	72-86	Landcruiser 40 series LDV leaf springs (46mm shorter than OE)	Rear	○ ○
RS999342	NISSAN	98-17	Patrol S/W 4x4 GR I / GU I Y61 Series (Coil springs) MC 02-on 3.0TDi & 4.8i GR II / GU II series Std height 14mm OD Studs	Front	⊥ T
RS999342	NISSAN	07 - on	Patrol 4.2D Pick-Up 4x4 LDV Leaf spring rear (Y61) 14mm OD Studs	Front	⊥ T
RS999342	TOYOTA	07-on	Landcruiser 76 & 78 series S/Wagon (Coil front, leaf rear) Std Susp	Front	⊥ T
RS999342	TOYOTA	99-on	Landcruiser HZJ79 series LDV Rear leaf springs, Coil front stud OD 13mm Std Susp	Front	⊥ T
RS999354	TOYOTA	83-89	Landcruiser 60 series S/Wagon Models #J6##V-... (FJ60, FJ62, HJ60, HJ6) Std Susp (10mm OD rod & 19mmID rubber bushing)	Front	⊥ ○
RS999354	TOYOTA	87- 99	Landcruiser HZJ75 series LDV leaf springs Standard Susp	Front	⊥ ○
RS999354	TOYOTA	06 - '16	Fortuner SUV 3.0TD & 4.0 V6 4x4 and 4x2 High Rider gen 1 (AN50 / AN60)	Rear	⊥ ○
RS999357	TOYOTA	90-98	Landcruiser 80 series S/Wagon (MC certain solid axle 105 series '98-'07 models) All Standard Susp	Rear	⊥ ⊖
RS999357	TOYOTA	03-Oct '09	Prado J120 (5 door) / J125 (3 door) Series (EXC elec susp) Std Height	Rear	⊥ ○
RS999358 >	TOYOTA	98-07	Landcruiser 100 Series S/Wagon IFS, MC Lexus IFS & Torsion Bars (EXC elec susp) Std Height	Front	⊥ ⊖
RS999359 ! >	TOYOTA	98-07	Landcruiser 100 Series S/Wagon IFS, MC Lexus IFS & Torsion Bars (EXC elec susp) Std Height	Rear	⊥ ⊖
RS999361 >	LAND ROVER	99- end 04	Discovery 2 MC Active ride control (L318)	Rear	⊖ ⊖
RS999362 >	LAND ROVER	94-on April '02	Range Rover Pegasus gen 2 (P38A) Std & Air Susp	Front	⊖ T
RS999363 >	LAND ROVER	94-on April '02	Range Rover Pegasus gen 2 (P38A) Std & Air Susp	Rear	⊖ T
RS999365	MITSUBISHI	99-April '07	Pajero 4x4 gen3 K94W, K96W, V64W, V65W, V68W, V74W, V75W & V78W (NM, NP) (EXC elec susp) Check OE #'s	Rear	⊥ ⊖
RS999365	MITSUBISHI	May'07-21	Pajero 4x4 gen 4 V80 (NT / NW)	Rear	⊥ ⊖
RS999762	TOYOTA	97-'02	Prado J90 series 3 door SWB S/W (EXC eye/eye rear mountings)	Front	⊥ ⊖
RS999762	TOYOTA	97-'02	Prado J95 series 5 door LWB S/W (EXC eye/eye rear mountings)	Front	⊥ ⊖
RS999762	TOYOTA	95-02	4-Runner & Surf Gen 3 (N180)	Front	⊥ ⊖
RS999764 * >	JEEP	02-07	Jeep Cherokee 4x4 (KJ)	Front	⊥
RS999764 * >	JEEP	08-13	Jeep Cherokee 4x4 (KK)	Front	⊥

Key



*	See important installation information on inside front cover
!	Excluding self-levelling suspension
"..."	Special order - phone 010 900 1850. 6-12 week waiting period

~	Imported
#	Internal bump stop
⊖	Steering damper

- It is recommended that all new shock absorbers are fitted in pairs
- Do not mix gas and non-gas units on the same axle
- **Bold** part numbers indicate heavy-duty shocks
- Underlined part numbers indicate parts not immediately available
- *Italic* part numbers followed by > indicate parts to be discontinued

Passenger and light commercial

Part number [numerical listing]

Part number	Make	Year	Application	Position	Mounting information
RS999777	TOYOTA	11-on	EJ Cruiser	Front	⊥ ⊕
RS999777	TOYOTA	09-on	4-Runner & Surf Gen 5 GN5 (N280) (EXC) KDSS susp	Front	⊥ ⊕
RS999777	TOYOTA	03-Oct '09	Prado J120 (5 door) / J125 (3 door) Series (EXC) elec susp Std Height	Front	⊥ ⊕
RS999778	FORD	end 11-19	Ranger 4x4 & 4x2 Hi-Trail raised body T6 (EXC) Raptor	Front	⊥ ⊕
RS999778	MAZDA	12-21	BT-50 4x4 & Hi-Trail 4x2 gen 2 (PN40, UP, UR) Std Ht	Front	⊥ ⊕
RS999782	FOTON	15-16	Toplander SUV (U201)	Front	⊥ ⊕
RS999782	FOTON	12-22	Tunland 2.8 4x2 & 4x4 pick up	Front	⊥ ⊕
RS999782	TOYOTA	March 06-16	Fortuner SUV 3.0TD & 4.0 V6 4x4 and 4x2 High Rider gen 1 (AN50 / AN60)	Front	⊥ ⊕
RS999782	TOYOTA	June 05-Jan 16	HiLux / Vigo "D4D" 4x4 & Raised body 4x2, gen 7 (AN10, AN20, AN30) Standard height	Front	⊥ ⊕
RS999802	MAZDA	99-April '07	Pajero 4x4 gen3 K94W, K96W, V64W, V65W, V68W, V74W, V75W & V78W (NM, NP) (EXC) elec susp Check OE #'s	Front	⊥ ⊕
RS999802	MAZDA	May '07-21	Pajero 4x4 gen 4 V80 (NT / NW)	Front	⊥ ⊕
SC2914	TOYOTA	79-84	Hilux 4x4 N30, N40) Steering Damper ⊕	Front	○ ⊥
SC2914	TOYOTA	84-End'98	Hilux All 4x4 (N505, N60) Steering Damper ⊕	Front	○ ⊥
SC2921	FORD	end 11-19	Ranger 4x4 & 4x2 Hi-Trail raised body T6 Steering Damper ⊕	Front	⊕ ⊕
SC2921	FORD	mid 19-22	Ranger 4x4 & 4x2 Hi-Trail raised body T6 (EXC) Raptor) Steering Damper ⊕	Front	⊕ ⊕
SC2928	JEEP	86- 96	Jeep Wrangler 4x4 (YJ series) Steering Damper ⊕	Front	○ ⊕
SC2928	JEEP	97-06	Jeep Wrangler 4x4 (TJ series) (EXC) Sport Steering Damper ⊕	Front	○ ⊕
SC2928	JEEP	93- 98	Jeep Grand Cherokee All (ZJ series) (EXC) Up- country Susp) Steering Damper ⊕	Front	○ ⊕
SC2941	SUZUKI	81- 87	SJ410, SJ413, SJ413-4, (leaf spring susp), (EXC) Samurai 4X4 Steering Damper ⊕	Front	⊕ ⊕
SC2941	SUZUKI	88-04	Samurai SJ413, 4X4 (Leaf spring susp) Steering Damper ⊕	Front	⊕ ⊕
SC2946	TOYOTA	90-98	Landcruiser 80 series S/Wagon (EXC) certain solid axle 105 series '98-'07 models) Steering Damper ⊕	Front	○ ○
SC2946	TOYOTA	72-86	Landcruiser 40 series LDV leaf springs Steering Damper ⊕	Front	○ ○
SC2946	TOYOTA	87- 99	Landcruiser HZJ75 series LDV leaf springs Steering Damper ⊕	Front	○ ○
SC2946	TOYOTA	99-07 only	Landcruiser HZJ79 series LDV Rear leaf springs, Coil front Steering Damper ⊕	Front	○ ○
SC2947	TOYOTA	End 98-May'05	Hilux P690 All 4x4 & raised body 4x2 (EXC) Raider IFS gen 6 Steering Damper ⊕	Front	○ ⊗
SC2947	TOYOTA	85-March '89	4-Runner & Surf RN61, LN 61 & YN63 4x4 IFS (EXC) elec susp (N60) Steering Damper ⊕	Front	○ ○
SC2947	TOYOTA	April '89 - 95	4-Runner & Surf gen 2 LN130, VZN130 (EXC) elec susp, RZN180, RZN185, VZN185 (N120, N130) Steering Damper ⊕	Front	○ ○
SC2962	JEEP	99-5/05	Jeep Grand Cherokee All (WJ series) (EXC) Up country susp) Steering Damper ⊕	Front	⊕ ⊕
SC2970	JEEP	07-18	Jeep Wrangler 4x4 (JK series) 2 & 4 door (EXC) Rubicon & Unlimited Steering Damper ⊕	Front	○ ⊕
V1018	VOLKSWAGEN	68-80	Kombi, Panelvan & Microbus (EXC) Fleettline)	Rear	⊕ ⊕
V1029 >	NISSAN	73-95	E20 van & Minibus	Rear	○ ⊥
V1029 >	DATSUN	65-80	1200, 1300, 1500, 1600, 620, 680 LDV (520, 521, 620 series)	Rear	○ ⊥
V1034	VOLKSWAGEN	62-69	1500, 1600 Sedan, Variant & Fastback (EXC) Automatics)	Front	⊕ ⊕
V1034	VOLKSWAGEN	68-80	Kombi, Panelvan & Microbus (EXC) Fleettline)	Front	⊕ ⊕
V1055	IVECO	All up till '89	30.8, 35.8, 35.10, 40.8, 40.10, 45.10, 49.10 (Check OE numbers)	Front	⊕ ⊕
V1055	IVECO	89 - 99	Turbo Daily 30.10, 35.10, 35.12 Leaf spring rear (check OE numbers)	Front	⊕ ⊕
V1055	IVECO	89-99	Turbo Daily 35.10, 35.12, 40.10, 40.12 Leaf spring rear. Chassis #'s 5973717 -> on (Check OE numbers)	Front	⊕ ⊕
V1055	IVECO	89-99	Turbo Daily 45.10, 45.12, 49.10, 49.12 (Check OE numbers)	Front	⊕ ⊕
V1063	CHEVROLET	72-78	 2500, 3800 & 4100 Sedan	Front	⊥ ⊕
V1063	CHEVROLET	75-78	(S/W) 2500 & 3800 S/Wagon	Front	⊥ ⊕
V1063	CHEVROLET	72-79	 (S/W) Constantia, Kommando & De Ville Sedan & S/Wagon	Front	⊥ ⊕
V1063	CHEVROLET	72-78	El Camino 6 or 8 Cylinder & El Toro	Front	⊥ ⊕

Key















*	See important installation information on inside front cover
!	Excluding self-leveling suspension
"..."	Special order - phone 010 900 1850. 6-12 week waiting period

~	Imported
#	Internal bump stop
⊕	Steering damper

- It is recommended that all new shock absorbers are fitted in pairs
- Do not mix gas and non-gas units on the same axle
- **Bold** part numbers indicate heavy-duty shocks
- Underlined part numbers indicate parts not immediately available
- *Italic* part numbers followed by > indicate parts to be discontinued

Passenger and light commercial

Part number [numerical listing]

Part number	Make	Year	Application	Position	Mounting information
V1063	OPEL	67-73	 Rekord 4 Cylinder	Front	
V1063	OPEL	68-73	 Rekord All 6 Cylinder	Front	
V1063	RANGER	68-73	 Sedan All	Front	
V1063	RANGER	68-73	[S/W] S/Wagon All	Front	
V1116	MERCEDES-BENZ	96-05	Sprinter van / bus. B901, B902 = 200 series, B903 = 300 series & B904 = 400 series. Gen 1 NB: Check Strut body length	Rear	
V1116	VOLKSWAGEN	03 - 06	LT 28, 32, 35 SWB Van Strut body length 319.5mm, Top eye 14mm ID / Btm eye 12mm ID	Rear	
V1166	VOLKSWAGEN	03 - 06	LT 45, 46 LWB Van Strut body length 345.5mm, Top eye 14mm ID / Btm eye 14mm ID	Rear	
V1167	NISSAN	07-14	Primastar van 1.9 Dci gen 2 (X83)	Rear	
V1167	OPEL	07-14	Vivaro 1.9CDTi, 2.0 Van & Minibus (X83)	Rear	
V1167	RENAULT	03 - 14	Trafic 1.9 Dci panel van gen 2 (X83)	Rear	
V1167	RENAULT	End14-on	Trafic 2.0TD panel van gen 3 (X82, FG)	Rear	
V1170	VOLKSWAGEN	Aug '04 - 15	Type V Caravelle, Kombi, Crew bus, Transporter LCV & Van T5  4Motion 4WD (front engine)  front struts with bottom camber brackets	Rear	
V1170	VOLKSWAGEN	16 - 0n	Type VI T6 Caravelle, California, Kombi, Transporter van, Crew bus & Van  4Motion 4WD  elec susp	Rear	
V1177	MERCEDES-BENZ	06-18	Sprinter 3 ton and 3.5 ton  4x4 gen 2 (B906)	Rear	
V1177	VOLKSWAGEN	06-17	Crafter 3 ton and 3.5 ton,  4x4 & 5 ton (2E/2F) Btm eye bushing ID = 12mm	Rear	
V1178	MERCEDES-BENZ	06-18	Sprinter 5 ton  4x4 (B906) - open length 520mm	Rear	
V1178	VOLKSWAGEN	06-17	Crafter 5 ton,  4x4, 3 ton & 3.5 ton (2E/2F) Btm eye bushing ID = 14mm	Rear	
V1188	MERCEDES-BENZ	06-18	Sprinter 5 ton  4x4 (B906) - open length 559mm	Rear	
V1191	IVECO	99-06	29.....	Rear	
V1191	IVECO	99-06	35C....	Rear	
V1191	IVECO	06-11	29...	Rear	
V1191	IVECO	06-11	35S..., 35C..., 40C.. 45C.. & 50C..	Rear	
V1191	MAHINDRA	16 - on	Pik-Up Single & D/C 4x2 & 4x4 LDV gen 1 facelift (16mm ID mtng top & btm. Closed 320mm & open 508mm)	Rear	
V1195	IVECO	99-06	29..... ..check OE #'s	Front	
V1195	IVECO	99-06	35C.... ..check OE #'s	Front	
V1197	IVECO	99-06	29..... ..check OE #'s	Front	
V1197	IVECO	99-06	35C.... ..check OE #'s	Front	
<u>V1197</u>	IVECO	11-14	35C..., 40C..., 50C... Check OE #'s	Front	
<u>V1201</u>	IVECO	99-06	35C.... ..check OE #'s	Front	
<u>V1201</u>	IVECO	06-11	35S..., 35C..., 40C.. 45C.. & 50C.. ..check OE #'s	Front	
<u>V1206</u>	IVECO	14-on	35S..., 35C..., 40C..., 50C...	Rear	
<u>V1207</u>	IVECO	14-on	35S..., 35C..., 40C..., 50C...	Rear	
<u>V1207</u>	IVECO	14-on	60C..., 65C..., 70C... rear dual tyres	Rear	
V1208	FORD	13-22	Tourneo Custom 8 seater minibus & Transit Custom van (V36X, F3, FY, FZ) FWD	Rear	
V1208	FORD	13-on	Transit van and Bus  chassis cab, Gen 4 (V363, FDC, FDD, FED, FFD) RWD	Rear	
V1501	MERCEDES-BENZ	02-04	Vito Minibus & Van 112 & 113 FWD (W638 Gen 1)	Rear	
V1502	IVECO	99-06	35C.... ..check OE #'s	Front	
<u>V1502</u>	IVECO	06-11	35S..., 35C..., 40C.. 45C.. & 50C.. ..check OE #'s	Front	
<u>V1502</u>	IVECO	99-06	29 L & 35 S Series (Check OE numbers)	Front	
<u>V1502</u>	IVECO	99-06	35 C & 40 C Series (Check OE numbers)	Front	
V2058	MERCEDES-BENZ	76-00	Unimog 403, 403, 404S, 406, 416, 416, 416	Front	

Key

*	See important installation information on inside front cover
!	Excluding self-levelling suspension
***	Special order - phone 010 900 1850. 6-12 week waiting period

~	Imported
#	Internal bump stop
⊕	Steering damper

- It is recommended that all new shock absorbers are fitted in pairs
- Do not mix gas and non-gas units on the same axle
- **Bold** part numbers indicate heavy-duty shocks
- Underlined part numbers indicate parts not immediately available
- *Italic* part numbers followed by > indicate parts to be discontinued

Passenger and light commercial

Part number [numerical listing]

Part number	Make	Year	Application	Position	Mounting information
V2058	MERCEDES-BENZ	76-00	Unimog 403, 403, 404S, 406, 416, 416, 416 - (OE# = 4043230000, 4043230100, 4063230000, 4063230200)	Rear	⊖ ⊖
V2065	VOLKSWAGEN	90- July'04	Type IV Caravelle T4  2.5 Tdi, Transporter & Syncro 4WD (front engine)	Front	⊥ ⊖
V2077	VOLKSWAGEN	90- July'04	Type IV Caravelle T4  2.5 Tdi, Transporter & Syncro 4WD (front engine)	Rear	⊖ T
V2079	NISSAN	07-'10	Interstar van & taxi	Front	○ ○
V2079	OPEL	98-12	Movano Van Mk1  pick-up rear (X70)	Front	⊖ ⊖
V2110	IVECO	89-99	35.8, 35.10, 40.10 Leaf spring rear Chassis #'s 5973717 -> on (Check OE numbers)	Rear	⊖ ⊖
V2110	IVECO	89-99	Turbo Daily 35.10, 35.12, 40.10, 40.12 Leaf spring rear. Chassis #'s 5973717 -> on (Check OE numbers)	Rear	⊖ ⊖
V2130	CITROEN	11-18	Jumper Van (Check original front piston rod outer diameters, & original rear open and closed lengths for correct shock selection)	Rear	⊖ ⊖
V2130	FIAT	July'06-on	  Ducato SWB & LWB Van & Minibus (Q11, Q15, Q17, Q20) Gen 3	Rear	⊖ ⊖
V2130	PEUGEOT	April '06-on	Boxer 2.2 Hdi, 3.0 Hdi Van LWB gen 3 (12Q, 14Q, 16Q, 20Q) 3.3 & 4.0 ton  Shock Length = Closed: 283mm, Open: 418mm	Rear	⊖ ⊖
V2131	CITROEN	11-18	Jumper Van (Check original front piston rod outer diameters, & original rear open and closed lengths for correct shock selection)	Rear	⊖ ⊖
V2131	FIAT	July'06-on	  Ducato SWB & LWB Van & Minibus (Q11, Q15, Q17, Q20) Gen 3	Rear	⊖ ⊖
V2131	PEUGEOT	April '06-on	Boxer 2.2 Hdi, 3.0 Hdi Van LWB gen 3 (12Q, 14Q, 16Q, 20Q) 3.3 & 4.0 ton  Shock length Closed: 315mm, Open: 476mm	Rear	⊖ ⊖
V2132	CITROEN	11-18	Jumper Van (Check original front piston rod outer diameters, & original rear lengths Closed: 293mm, Open: 444mm)	Rear	⊖ ⊖
V2132	FIAT	July'06-on	  Ducato SWB & LWB Van & Minibus (Q11, Q15, Q17, Q20) Gen 3 Lengths: Closed: 293mm, Open: 444mm	Rear	⊖ ⊖
V2132	PEUGEOT	April '06-on	Boxer 2.2 Hdi, 3.0 Hdi Van LWB gen 3 (12Q, 14Q, 16Q, 20Q) 3.3 & 4.0 ton  (Check front piston rod OD, and rear open and closed lengths Closed: 293mm, Open: 444mm)	Rear	⊖ ⊖
<u>V2135</u>	IVECO	99-06	29.....	Rear	⊖ ⊖
<u>V2135</u>	IVECO	99-06	35C....	Rear	⊖ ⊖
<u>V2135</u>	IVECO	99-06	29 L & 35 S Series (Check OE numbers)	Rear	⊖ ⊖
<u>V2136</u>	IVECO	99-06	29.....	Rear	⊖ ⊖
<u>V2136</u>	IVECO	99-06	35C....	Rear	⊖ ⊖
<u>V2136</u>	IVECO	06-11	29...	Rear	⊖ ⊖
<u>V2136</u>	IVECO	06-11	35S..., 35C..., 40C.. 45C.. & 50C..	Rear	⊖ ⊖
<u>V2136</u>	IVECO	11-14	35C..., 40C..., 50C...	Rear	⊖ ⊖
<u>V2136</u>	IVECO	14-on	35S..., 35C..., 40C..., 50C...	Rear	⊖ ⊖
<u>V2136</u>	IVECO	99-06	29 L & 35 S Series (Check OE numbers)	Rear	⊖ ⊖
<u>V2151</u>	IVECO	06-11	35S..., 35C..., 40C.. 45C.. & 50C..	Rear	⊖ ⊖
<u>V2151</u>	IVECO	11-14	35C..., 40C..., 50C...	Rear	⊖ ⊖
<u>V2151</u>	IVECO	14-on	35S..., 35C..., 40C..., 50C...	Rear	⊖ ⊖
<u>V2152</u>	IVECO	06-11	60C..., 65C..., 70C...	Rear	⊖ ⊖
<u>V2152</u>	IVECO	11-14	65C..., 70C...	Rear	⊖ ⊖
<u>V2152</u>	IVECO	14-on	60C..., 65C..., 70C... rear dual tyres	Rear	⊖ ⊖
V2158	HYUNDAI	09-21	H-1 Minibus 9 seater / Van gen 2 (TQ) incl facelifts	Rear	⊖ ⊖
<u>V2159</u>	IVECO	14-on	35S..., 35C..., 40C..., 50C... Check OE#'s	Front	⊖ ⊖
<u>V2161</u>	FORD	13-22	Tourneo Custom 8 seater minibus & Transit Custom van (V36X, F3, FY, FZ) FWD	Rear	⊖ ⊖
<u>V2161</u>	FORD	13-on	Transit van and Bus  chassis cab, Gen 4 (V363, FDC, FDD, FED, FFD) RWD	Rear	⊖ ⊖
V2401	VOLKSWAGEN	85- 03	Kombi, Microbus Type III Syncro 4x4  Front engine T4	Front	⊥ ⊖
V2505	MAHINDRA	end 15 - Jan '22	Scorpio 4x2 & 4x4 SUV (S11) gen 1 facelift (12mm ID mtng top & btm. Closed 362mm & open)	Rear	⊖ ⊖
V2505	VOLKSWAGEN	85- 03	Kombi, Microbus Type III Syncro 4x4  Front engine T4	Rear	⊖ ⊖
V2507	PEUGEOT	99-06	Boxer Van 1.4 ton SWB gen 2	Rear	⊖ ⊖

Key

*	See important installation information on inside front cover
!	Excluding self-leveling suspension
"..."	Special order - phone 010 900 1850. 6-12 week waiting period

~	Imported
#	Internal bump stop
⊖	Steering damper

- It is recommended that all new shock absorbers are fitted in pairs
- Do not mix gas and non-gas units on the same axle
- **Bold** part numbers indicate heavy-duty shocks
- Underlined part numbers indicate parts not immediately available
- *Italic* part numbers followed by > indicate parts to be discontinued

Passenger and light commercial

Part number [numerical listing]

Part number	Make	Year	Application	Position	Mounting information
V2507	FIAT	02-June'06	 Ducato 10, 14 Van 2.3JTD, 2.8JTD – 1.5 ton Gen 2 OE#1312314080 or 1314562081	Rear	⊖ ⊖
V2509	PEUGEOT	99-06	Boxer Van 1.8 ton LWB gen 2	Rear	⊖ ⊖
V2514	NISSAN	07-'10	Interstar van & taxi (Leaf spring susp)	Rear	○ ○
V2514	OPEL	98-12	Movano Van Mk1  pick-up rear) (X70) (leaf spring van)	Rear	⊖ ⊖
V2515	IVECO	99-06	35C...	Rear	⊖ ⊖
V2515	IVECO	99-06	40C..., 45C... & 50C...	Rear	⊖ ⊖
V2515	IVECO	99-06	65C...	Rear	⊖ ⊖
<u>V2515</u>	IVECO	06-11	35S..., 35C..., 40C... 45C... & 50C...	Rear	⊖ ⊖
<u>V2515</u>	IVECO	06-11	60C..., 65C..., 70C...	Rear	⊖ ⊖
<u>V2515</u>	IVECO	11-14	35C..., 40C..., 50C...	Rear	⊖ ⊖
<u>V2515</u>	IVECO	11-14	65C..., 70C...	Rear	⊖ ⊖
<u>V2515</u>	IVECO	14-on	35S..., 35C..., 40C..., 50C...	Rear	⊖ ⊖
<u>V2515</u>	IVECO	14-on	60C..., 65C..., 70C... rear dual tyres	Rear	⊖ ⊖
V2515	IVECO	99-06	35 C & 40 C Series (Check OE numbers)	Rear	⊖ ⊖
V2515	IVECO	99-06	50 C Series ( 40 C & 50 C bus)	Rear	⊖ ⊖
V2515	IVECO	01-06	65 C Series	Rear	⊖ ⊖
V2515	IVECO	89-99	Turbo Daily 45.10, 45.12, 49.10, 49.12 (Check OE numbers)	Rear	⊖ ⊖
V2516	IVECO	99-06	40C..., 45C... & 50C... (Multi-link susp)	Front	⊖ ⊖
V2516	IVECO	06-11	35S..., 35C..., 40C... 45C... & 50C... ..check OE #'s	Front	⊖ ⊖
V2516	IVECO	11-14	35C..., 40C..., 50C... Check OE #'s	Front	⊖ ⊖
V2516	IVECO	14-on	35S..., 35C..., 40C..., 50C... Check OE #'s	Front	⊖ ⊖
V2516	IVECO	99-06	35 C & 40 C Series (Check OE numbers)	Front	⊖ ⊖
V2516	IVECO	99-06	50 C Series ( 40 C & 50 C bus)	Front	⊖ ⊖
V2516	IVECO	99-06	35C...	Rear	⊖ ⊖
V2518	IVECO	99-06	65C...	Front	⊖ ⊖
<u>V2518</u>	IVECO	06-11	60C..., 65C..., 70C... ..check OE #'s	Front	⊖ ⊖
<u>V2518</u>	IVECO	11-14	65C..., 70C...	Front	⊖ ⊖
<u>V2518</u>	IVECO	14-on	60C..., 65C..., 70C... rear dual tyres	Front	⊖ ⊖
V2518	IVECO	01-06	65 C Series	Front	⊖ ⊖
V4301	MERCEDES-BENZ	02-04	Vito Minibus & Van 112 & 113 FWD (W638 Gen 1)	Front	
V4306A  V4307A 	HYUNDAI	09-21	H-1 Minibus 9 seater / Van gen 2 (TQ) incl facelifts	Front	
V4410	PEUGEOT	99-06	Boxer Van 1.8 ton LWB gen 2	Front	
V4501	FIAT	02-June'06	 Ducato 10, 14 Van 2.3JTD, 2.8JTD – 1.0 ton & 1.5 ton Gen 2	Front	
V4501	PEUGEOT	99-06	Boxer Van 1.4 ton SWB gen 2	Front	
V4503	VOLKSWAGEN	03 – 06	LT 28, 32, 35 SWB Van Strut body length 319.5mm	Front	
V4503	VOLKSWAGEN	03 – 06	LT 45, 46 LWB Van Strut body length 319.5mm	Front	
V4503	MERCEDES-BENZ	96-05	Sprinter van / bus. B901, B902 = 200 series, B903 = 300 series & B904 = 400 series. Gen 1 NB: (body length 319.5mm *) or	Front	
V4504	NISSAN	07-14	Primastar van 1.9 Dci gen 2 (X83)	Front	
V4504	OPEL	07-14	Vivaro 1.9CDTi, 2.0 Van & Minibus (X83)	Front	
V4504	RENAULT	03 – 14	Trafic 1.9 Dci panel van gen 2 (X83)	Front	
V4505	VOLKSWAGEN	Aug '04 – 15	Type V Caravelle, Kombi, Crew bus, Transporter LCV & Van T5  4Motion 4WD (front engine)  front struts with bottom camber brackets	Front	

Key

*	See important installation information on inside front cover
!	Excluding self-levelling suspension
***	Special order – phone 010 900 1850. 6-12 week waiting period

~	Imported
#	Internal bump stop
⊖	Steering damper

- It is recommended that all new shock absorbers are fitted in pairs
- Do not mix gas and non-gas units on the same axle
- **Bold** part numbers indicate heavy-duty shocks
- Underlined part numbers indicate parts not immediately available
- *Italic* part numbers followed by > indicate parts to be discontinued

Passenger and light commercial

Part number [numerical listing]

Part number	Make	Year	Application	Position	Mounting information
V4505	VOLKSWAGEN	16 - 0n	Type VI T6 Caravelle, California, Kombi, Transporter van, Crew bus & Van inc 4Motion 4WD exc elec susp	Front	
V4507	MERCEDES-BENZ	96-05	Sprinter van / bus. B901, B902 = 200 series, B903 = 300 series & B904 = 400 series. Gen 1 NB: (body length 345.5mm *)	Front	
V4507	VOLKSWAGEN	03 - 06	LT 28, 32, 35 SWB Van Strut body length 345.5mm	Front	
V4507	VOLKSWAGEN	03 - 06	LT 45, 46 LWB Van Strut body length 345.5mm	Front	
V4510	MERCEDES-BENZ	06-18	Sprinter 3 ton and 3.5 ton exc 4x4 gen 2 (B906)	Front	
V4510	VOLKSWAGEN	06-17	Crafter 3 ton and 3.5 ton, exc 4x4 & 5 ton (2E/2F)	Front	
V4511	MERCEDES-BENZ	06-18	Sprinter 5 ton exc 4x4 (B906)	Front	
V4511	VOLKSWAGEN	06-17	Crafter 5 ton, exc 4x4, 3 ton & 3.5 ton (2E/2F)	Front	
V4512	CITROEN	11-18	Jumper Van (Check original front piston rod outer diameters, & original rear open and closed lengths for correct shock selection) (Rod outer diameter = 25mm)	Front	
V4512	FIAT	July'06-on	Ducato SWB & LWB Van & Minibus (Q11, Q15, Q17, Q20) Gen 3 (Rod outer diameter = 25mm)	Front	
V4512	PEUGEOT	April '06-on	Boxer 2.2 Hdi, 3.0 Hdi Van LWB gen 3 - Piston rod OD = 25mm, (12Q, 14Q, 16Q, 20Q) 3.3 & 4.0 ton exc 4x4	Front	
V4513	CITROEN	11-18	Jumper Van (Check original front piston rod outer diameters, & original rear open and closed lengths for correct shock selection) (Rod outer diameter = 28mm)	Front	
V4513	FIAT	July'06-on	Ducato SWB & LWB Van & Minibus (Q11, Q15, Q17, Q20) Gen 3 (Rod outer diameter = 28mm)	Front	
V4513	PEUGEOT	April '06-on	Boxer 2.2 Hdi, 3.0 Hdi Van LWB gen 3 - Piston rod OD = 28mm (12Q, 14Q, 16Q, 20Q) 3.3 & 4.0 ton exc 4x4 (Check front piston rod OD, and rear open and closed lengths for correct shock selection)	Front	
V4516	MERCEDES-BENZ	July'10-Sept '14	Viano 7 seater MPV 2.2 Cdi, 3.0 Cdi, 3.5V6 inc air susp (W639 gen 2 facelift) exc AWD	Front	
V4516	MERCEDES-BENZ	Sept'10-Sept '15	Vito Van 113, 115, 116, 122 RWD inc air susp (W639 Gen 2 facelift) exc AWD	Front	
<u>V4518</u>	FORD	13-on	Transit van and Bus inc chassis cab, Gen 4 (V363, FDC, FDD, FED, FFD) RWD	Front	
<u>V4518</u>	FORD	13-22	Tourneo Custom 8 seater minibus & Transit Custom van (V36X, F3, FY, FZ) FWD	Front	
<u>V4519</u>	FORD	13-22	Tourneo Custom 8 seater minibus & Transit Custom van (V36X, F3, FY, FZ) FWD	Front	
<u>V4519</u>	FORD	13-on	Transit van and Bus inc chassis cab, Gen 4 (V363, FDC, FDD, FED, FFD) RWD	Front	
V4520	RENAULT	End14-on	Trafic 2.0TD panel van gen 3 (X82, FG)	Front	
V4521	FORD	13-22	Tourneo Custom 8 seater minibus & Transit Custom van (V36X, F3, FY, FZ) FWD	Front	
V4521	FORD	13-on	Transit van and Bus inc chassis cab, Gen 4 (V363, FDC, FDD, FED, FFD) RWD	Front	
V5007	MERCEDES-BENZ	06-June'10	Viano 7 seater MPV 2.2 Cdi, 3.0 Cdi, 3.5V6 inc air susp (W639 gen 2) exc OE# 6393264000	Rear	
V5007	MERCEDES-BENZ	July'10-Sept '14	Viano 7 seater MPV 2.2 Cdi, 3.0 Cdi, 3.5V6 inc air susp (W639 gen 2 facelift) exc AWD exc OE# 6393264000	Rear	
V5007	MERCEDES-BENZ	04-Aug '10	Vito Minibus & Van 109CDi, 111CDi, 115CDi, 119, 120CDi, 122, 123, 126 (3.5) RWD inc air susp (W639 Gen 2) exc OE# 6393264000	Rear	
V5007	MERCEDES-BENZ	Sept'10-Sept '15	Vito Van 113, 115, 116, 122 RWD inc air susp (W639 Gen 2 facelift) exc AWD exc OE# 6393264000	Rear	
V5008	MERCEDES-BENZ	Oct '15 - on	V Class 7 seater MPV minibus V200d, V220d, V250d, V300d (W447 Gen 3) (inc AWD)	Rear	
V5008	MERCEDES-BENZ	Oct '15 - on	Vito Van 111 (1.6 FWD), 114, 116, 119 (2.2 RWD) (W447 Gen 3) exc AWD	Rear	

Key



































































*	See important installation information on inside front cover
!	Excluding self-levelling suspension
"..."	Special order - phone 010 900 1850. 6-12 week waiting period

~	Imported
#	Internal bump stop
⊕	Steering damper

- It is recommended that all new shock absorbers are fitted in pairs
- Do not mix gas and non-gas units on the same axle
- **Bold** part numbers indicate heavy-duty shocks
- Underlined part numbers indicate parts not immediately available
- *Italic* part numbers followed by > indicate parts to be discontinued

Passenger and light commercial

Part number [numerical listing]

Part number	Make	Year	Application	Position	Mounting information
SPECIAL ORDER					
"10026"  "10027" 	NISSAN	92-July'00	Micra (K11) cross border applications gen2	Front	
"10058"  "10059" 	NISSAN	Aug '00-03	Micra (K11) cross border applications gen2	Front	
"11036"	RENAULT	Mid 83-86	R9 & R11 All	Front	
"11592"  "11593" 	TOYOTA	90-00	Previa std & GL (ABS) Rear IRS TCR 11 & 21 (gen 1 XR10, XR20)	Front	
"11616"	PEUGEOT	93-95	405 Sedan & S/Wagon  Sri, Stl, Mi16 & T16)	Front	
"11655"	RENAULT	99-01	Laguna Sedan (B56 / K56) Larger 16mm camber bolt mntg holes.Camber brkt width 34mm OE#s 7700830491 or 7700830492 = 11655	Front	
"11655"	RENAULT	95- 00	Laguna S/Wagon (B56 / K56)	Front	
"11669"	VOLVO	94- 96	850 Sedan & S/Wagon  Lowered and Nivomat self leveling suspension)	Front	
"11669"	VOLVO	97-05	  C70 Coupe & Cabrio	Front	
"11669"	VOLVO	97-'00	S70 Sedan  lowered and Nivomat leveling suspension)	Front	
"11669"	VOLVO	97- Feb'00	V70 S/Wagon Gen1  Elec Four-C & Nivomat rears)	Front	
"11741"	RENAULT	96-'00	Safrane	Front	
"11743"	RENAULT	99-01	Laguna Sedan (B56 / K56) Smaller 14mm camber bolt mntg holes. Camber brkt width 24mm Shock OE#s 7700830490 = 11743	Front	
"16406"	ALFA ROMEO	97-05	156 ALL  GTA, Sport susp)	Rear	
"16406"	ALFA ROMEO	00-06	156 Sportwagon  GTA / elec susp / self leveling rears)	Rear	
"16417"	FIAT	04-05	Punto 1.8 HGT 1.6v 3 door Hatch, plus 1.4 Sport Susp (MkII) (188)	Front	
"16430"	FORD	Sept'01-07	  Mondeo Sedan & Coupe  18' Wheels & Sport susp	Front	
"16430"	FORD	Sept'01-07	(S/W) Mondeo S/Wagon	Front	
"16431"	FORD	Sept'01-07	  Mondeo Sedan & Coupe  18' Wheels & Sport susp	Rear	
"16470"	FIAT	03-early 10	Doblo 1.3, 1.4 & 1.9 Cargo panel Van (119) (223)	Front	
"16473"  "16474" 	HONDA	March '01-05	Civic Vtec 5 door hatch (EP, EU) Mk7 1.3, 1.4, 1.5, 1.6, 1.7i 2.0  Type R) & 1.7D	Front	
"16475"  "16476" 	FIAT	06-09	Croma (generation II)	Front	
"16483"  "16484" 	SUBARU	98 - May'02	Forester 1 AWD 2.0 & 2.5  Self leveling, elec or air susp) (SF gen 1)	Front	
"16491"  "16492" 	SUBARU	00-04	  Legacy III 2.0 & 2.5 4x4  Air susp, 3.0 & Outback) (BE/BH)	Front	
"16538"	ALFA ROMEO	90- 98	164  elec. susp./ leveling systems)	Rear	
"16539"	SAAB	87-97	9000CD, CS, CDE & CSE	Front	
"16575" >	MITSUBISHI	91-99	Space Runner / RVR  AWD) N11W, N18W	Front	
"16599"	ALFA ROMEO	91- 97	155 2500 V6, 2.5TD  elec susp)	Front	
"16705"	MERCEDES-BENZ	93- '9/02	SL280, SL320 & SL500 Only Chassis #: F054768 ->  SL600) (R129 facelift)	Front	
"16721"	FORD	98-Sept'01	 Mondeo 1.8,2.0 & 2.5 Si sedan	Front	
"16721"	FORD	98- Sept'01	(S/W) Mondeo 2.0 S/Wagon	Front	
"22712"	OPEL	05 - 09	Tigra 1.4, 1.8 TwinTop Cabriolet (rear disc brakes only)	Rear	 
"23313"	TOYOTA	89-94	Starlet EP80, EP81, EP82, NP80	Rear	 
"23315"	TOYOTA	94-96	Starlet EP80, EP81, EP82, NP80	Rear	 
"23431"	OPEL	92- 98	Calibra 2.0 16v & 2.5 V6  Turbo)	Rear	 
"23442"	HYUNDAI	89-94	Excel / Pony	Rear	 
"23442"	HYUNDAI	90-97	Scoupe	Rear	 
"23442"	MITSUBISHI	83-86	Tredia Sedan  Turbo	Rear	 
"23748"	HONDA	89-91	Ballade 1500 & 1600  local CRX  those with rear bottom U brackets -> Special order) Mk4 (SH4 / EF)	Rear	 

Key



*	See important installation information on inside front cover
!	Excluding self-leveling suspension
"..."	Special order - phone 010 900 1850. 6-12 week waiting period

~	Imported
#	Internal bump stop
⊕	Steering damper

- It is recommended that all new shock absorbers are fitted in pairs
- Do not mix gas and non-gas units on the same axle
- **Bold** part numbers indicate heavy-duty shocks
- Underlined part numbers indicate parts not immediately available
- *Italic* part numbers followed by > indicate parts to be discontinued

Passenger and light commercial

Part number [numerical listing]

Part number	Make	Year	Application	Position	Mounting information
SPECIAL ORDER					
"23748"	HONDA	92-95	Ballade All (MCI) local Encore & CRX (EXCI) those with rear bottom U brackets) Mk5 SR4 or EG	Rear	⊥ ⊕
"23810" >	HYUNDAI	94-98	Sonata (Y3) gen 3	Rear	⊥ ⊕
"23842"	AUDI	96- Jan'99	 A4 Avant (EXCI) Quattro, Sport) 8D, B5	Rear	⊥ ⊕
"23853"	TOYOTA	96-00	Starlet EP91	Rear	⊥ ⊕
"23871"	HONDA	95-99	Odyssey Type RA1, RA3	Rear	⊥ ○
"23874"  "23875" 	HONDA	95-99	Odyssey Type RA1, RA3	Front	⊥ ⊗
"23884"	TOYOTA	95-'01	Ipsum / Picnic 7 seater MPV (XM10)	Rear	⊥ ○
"23906"	AUDI	Feb'99-Nov'00	 A4 Avant (EXCI) Sport susp, sedan & Quattro B5, 8D	Rear	⊥ ⊕
"23908"	OPEL	01-06	Astra Coupe & Cabriolet (G)	Rear	⊖ ⊖
"23925"	VOLKSWAGEN	99-05	Golf IV 1.6 Estate S/Wagon	Rear	⊥ ⊕
"23925"	VOLKSWAGEN	00-05	Golf IV 1.9 Tdi Estate S/Wagon	Rear	⊥ ⊕
"23934"	NISSAN	01-'03	 Almera / Sunny Hatch (N16E)	Rear	⊥ ⊕
"23935"	FORD	05-09	Ka 1.3 Hatch	Rear	⊥ ⊕
"23945"	MG	03-06	MG ZT Sports Sedan	Rear	⊥ ○
"23945"	ROVER	03-05	25 Hatch	Rear	⊥ ○
"23956"	AUDI	02-08	 A4 Cabriolet (MCI) Sport susp	Rear	⊥ ⊕
"23974"	HYUNDAI	01-08	Trajet 2.0d & 2.7 MPV (F0)	Rear	⊖ ⊖
"23976"	VOLKSWAGEN	93-99	Golf III & Jetta III VR6	Rear	⊗ ⊖
"23985"	CITROEN	02-09	 C3 Pluriel & Enterprise models – Convertible (HB)	Rear	○ ○
"25505"	CITROEN	Nov'10-16	C4 (Gen 2) 1.6i, 2.0, 2.0 HDi (EXCI) DS4 & sport susp)	Rear	⊥ ○
"25505"	PEUGEOT	08-10	(S/W) 308 1.6 S/Wagon (EXCI) 1.6T gen 1 (T7)	Rear	⊥ ○
"25506"	FIAT	03-early 10	Doblo 1.3, 1.4 & 1.9 Cargo panel Van (119) (223)	Rear	⊖ ⊖
"26339"	AUDI	91-94	500 Quattro sedan and Avant S/W std susp (EXCI) S4 & sport susp)	Rear	⊥ ⊕
"26339"	AUDI	94-July'97	A6 Sedan & Avant Quattro (EXCI) Sport suspension & S6)	Rear	⊥ ⊕
"26340"	AUDI	91-94	500 Quattro sport suspension sedan and Avant S/W (EXCI) S4)	Rear	⊥ ⊕
"26340"	AUDI	91-94	S4 2.2 (EXCI) 4.2 & sports susp)	Rear	⊥ ⊕
"26340"	AUDI	94-July'97	A6 & S6 4.2 Sedan & Avant Quattro Sport suspension (EXCI) S6)	Rear	⊥ ⊕
"26624"	BMW	Mid 85-89	518, 520, 525, 525e, 528 & 535e (E28) (EXCI) M Tech)	Rear	⊗ ⊖
"26624"	BMW	6/82 - '90	628CSi, 635CSi (E24) (EXCI) elec suspension)	Rear	⊗ ⊖
"26634"	BMW	86-88	730, 735 (E32) (EXCI) elec suspension & M Tech)	Rear	⊗ ⊖
"26634"	BMW	89-90	730, 735 (E32) (EXCI) elec suspension & M Tech)	Rear	⊗ ⊖
"26634"	BMW	91-94	730, 735 & 740 (E32) (EXCI) 750 & elec suspension & M Tech)	Rear	⊗ ⊖
"37035" ! >	FORD	95-01	Explorer 4x4 (EXCI) Auto ride ht control – Special order)	Rear	⊕ ⊖
"37035" >	FORD	91-94	Explorer	Rear	⊕ ⊖
"37120"	JEEP	86- 96	Jeep Wrangler 4x4 (YJ series) Std Height	Front	⊥ ⊕
"37121"	JEEP	86- 96	Jeep Wrangler 4x4 (YJ series) Std Height	Rear	○ ⊖
"37123ST"	CHRYSLER	95-00	Voyager 2.0 SWB & Grand Voyager (GS) 3.3 V6 & 2.5 TD LWB (EXCI) Rear Nivomat leveling susp & 4x4)	Rear	⊖ ⊖
"37123ST"	CHRYSLER	01-07	Voyager 2.0 & 2.4 SWB; & Grand Voyager 2.8, 3.3 V6 & 2.5TD LWB (EXCI) Rear Nivomat leveling susp & AWD 4x4)	Rear	⊖ ⊖
"37282ST"	NISSAN	05-end 08	Murano 3.5 V6 4x4 SUV gen 1 (Z50)	Rear	⊥ ⊕
"37380ST"	JEEP	22-on	Jeep Gladiator pickup (LN) Std Height	Front	⊖ ⊖
"37380ST"	JEEP	18-on	Jeep Wrangler (JL series) Std Height	Front	⊖ ⊖

Key

*	See important installation information on inside front cover
!	Excluding self-leveling suspension
"..."	Special order – phone 010 900 1850. 6-12 week waiting period

~	Imported
#	Internal bump stop
⊕	Steering damper

- It is recommended that all new shock absorbers are fitted in pairs
- Do not mix gas and non-gas units on the same axle
- **Bold** part numbers indicate heavy-duty shocks
- Underlined part numbers indicate parts not immediately available
- *Italic* part numbers followed by > indicate parts to be discontinued

Passenger and light commercial

Part number [numerical listing]

Part number	Make	Year	Application	Position	Mounting information
SPECIAL ORDER					
"37381ST"	JEEP	18-on	Jeep Wrangler (JL series) Std Height	Rear	⊖ ⊖
"37395ST" >	JEEP	14-21	Jeep Cherokee 4x4 INC Trailhawk (KL)	Rear	⊥ ⊖
"37416ST"	JEEP	22-on	Jeep Gladiator pickup (LN) Std Height	Rear	
"376016SP"	BMW	Nov'03-May'10	All E60 5 Series sedan Sport susp EXC Touring S/W, & M5)	Rear	⊥ ⊖
"376018SP" >	BMW	90-99	E36 M Tech (BMW Motorsport)	Rear	⊗ ⊖
"376043SP"	MERCEDES-BENZ	Aug '02-09	W211 E200K, E220 Cdi, E240, E270CDi, E280, E320, E350, E500, E320CDi – Sport Susp EXC S/Wagon, AMG & Elec & air susp)	Rear	⊥ ⊖
"376069SP"	MERCEDES-BENZ	94 – Aug '01	S/Wagon, EXC Sport susp (W202)	Rear	⊥ ⊖
"376069SP"	MERCEDES-BENZ	98-03	 CLK320 & CLK430 Cabriolet (A208)	Rear	⊥ ⊖
"376074SP"	MERCEDES-BENZ	98-March '02	 CLK320 & CLK430 Coupe (C208)	Rear	⊥ ⊖
"376097SP"	PEUGEOT	11-14	5008 1.6 THP MPV gen 1 (T8)	Rear	○ ○
"376110SP"	RENAULT	01-04	Scenic RX4 4x4	Rear	⊖ ⊖
"376152SP"	NISSAN	00-00	Maxima QX (A33) & Infinity EXC elec susp)	Rear	⊥ ○
"376152SP"	NISSAN	01-03	Maxima QX (A33) & Infinity EXC elec susp)	Rear	⊥ ○
"376154SP"	PEUGEOT	11-18	508 sedan gen 1 (W23, 8D)	Rear	⊥ ○
"376160SP" >	FORD	Sept'01-07	[S/W] Mondeo S/Wagon	Rear	⊖ ⊖
"376170SP"	MERCEDES-BENZ	98-March '02	 CLK320 & CLK430 Coupe (C208)	Front	⊥ ⊖
"376170SP"	MERCEDES-BENZ	98-03	 CLK320 & CLK430 Cabriolet (A208)	Front	
"376178SP" >	AUDI	08-Jan 16	S5 Sportback Coupe & Cabrio INC A5 Sport Susp, Quattro EXC RS5 4.2 V8 (8T)	Front	⊥ ⊗
"376200SP"	MERCEDES-BENZ	Aug '02-mid 09	S211 S/Wagon E200K, E220 Cdi, E280, E320CDi, E350, E500 – Std susp EXC AMG & Elec & air susp)	Rear	⊥ ⊖
"376204SP"	BMW	04-May'10	All E61 5 Series Touring EXC Sedan, M5 & Sport susp)	Rear	⊥ ⊖
"376206SP"	MERCEDES-BENZ	Aug '02-mid 09	S211 S/Wagon E200K, E220 Cdi, E280, E320CDi, E350, E500 – Sport Susp EXC AMG & Elec & air susp)	Rear	⊥ ⊖
"376214SP"	AUDI	08-Jan 16	  A4 Sedan & Avant Sport Susp, INC Quattro EXC S4 & Elec susp) B8	Rear	⊥ ⊖
"376214SP"	AUDI	08-Jan 16	S5 Sportback Coupe & Cabrio INC A5 Sport Susp, Quattro EXC RS5 4.2 V8 (8T)	Rear	⊥ ⊖
"376221SP"	PEUGEOT	01-07	607 3.0 V6 EXC elec susp)	Rear	○ ○
"376238SP" >	AUDI	Feb'99-Nov'00	 A4 Avant Quattro EXC S4 & Sport suspension)	Rear	○ ○
"376238SP" >	AUDI	Feb'99-Nov'00	 A4 Sport Quattro EXC S4) B5, 8D	Rear	○ ○
"376242SP"	SMART	14-on	ForFour 0.9 & 1.0 gen 2 EXC Brabus (W453 gen 2)	Rear	⊥ ○
"376242SP"	SMART	End14-on	ForTwo all 1.0 INC cabrio EXC Brabus (W453 gen 3)	Rear	⊥ ○
"376245SP"	CITROEN	13-17	C4 Cactus crossover SUV	Rear	○ ○
"376254SP"	AUDI	Feb 16-on	 A4 Sedan INC Quattro (8W) Sport susp EXC S4) B9 (48mm btm mtng housing diam)	Front	⊥ ⊗
"376254SP"	AUDI	Feb '16 – on	A5 Sportback Coupe, Cabrio & Quattro EXC RS5) (F5, B9) (48mm housing)	Front	⊥ ⊗
"376254SP"	AUDI	Feb 16 – on	S5 Sportback Coupe & Cabrio INC A5 Sport Susp, Quattro EXC RS5 4.2 V8 (B9) (48mm housing)	Front	⊥ ⊗
"376257SP"	RENAULT	Sept 16-22	Megane IV Hatch 1.2T, 1.6, EXC 2.0T GT & 1.8 RS)	Rear	⊖ ⊙
"376265SP"	HYUNDAI	17-18	i30 Hatch gen 3 (PD) EXC 2.0T i30N performance model	Rear	⊥ ⊖
"42045"	RENAULT	94-96	Espace MPV EXC air susp & sealed front struts)	Rear	⊖ ○
"42061"	RENAULT	96-'02	Espace (J66 / P52) + Grand Espace (D66) MPV INC air susp	Rear	⊖ ⊖
"43001"	MERCEDES-BENZ	68-77	220, 230, 240 & 280E (114, 115 Series)	Front	⊥ ⊗
"43001"	MERCEDES-BENZ	71-89	280SL & SLC, 350SL & SLC, 380SL & SLC, 450SL & SLC, 500SL EXC elec or self leveling susp (R107) (C107)	Front	⊥ ⊗
"43063"	PEUGEOT	93-95	405 Sedan & S/Wagon EXC Sri, Stl, Mi16 & T16)	Rear	⊖ ⊖
"43067"	JAGUAR	86-End 94	XJ6, XJ12 Daimler Sovereign & Double Six (XJ40 Series)	Front	⊥ ⊗
"43067"	JAGUAR	Early 94-End 94	XJ12, Daimler Double six (XJ40 Series)	Front	⊥ ⊗

Key



















*	See important installation information on inside front cover
!	Excluding self-leveling suspension
"..."	Special order – phone 010 900 1850. 6-12 week waiting period

~	Imported
#	Internal bump stop
⊖	Steering damper

- It is recommended that all new shock absorbers are fitted in pairs
- Do not mix gas and non-gas units on the same axle
- **Bold** part numbers indicate heavy-duty shocks
- Underlined part numbers indicate parts not immediately available
- *Italic* part numbers followed by > indicate parts to be discontinued

Passenger and light commercial

Part number [numerical listing]

Part number	Make	Year	Application	Position	Mounting information
SPECIAL ORDER					
"43079"	SAAB	87-97	9000CD, CS, CDE & CSE	Rear	⊥ ⊖
"43087"	MERCEDES-BENZ	92-93	500SEC, 600SEC (C140)	Front	⊗ ⊖
"43087"	MERCEDES-BENZ	93-mid99	300SE, 400SE, 500SE, (all MC SEL) & S320, S430, S500 (W140) 300 Limo	Front	⊗ ⊖
"43087"	MERCEDES-BENZ	93-mid99	Limo S500L & S600L (V140) + W140 S600	Front	⊗ ⊖
"43087"	MERCEDES-BENZ	93 - 99	CL500, CL600 (C140) 300 elec susp	Front	⊗ ⊖
"43118"	RENAULT	01-07	Laguna II All, MC S/Wagon (X74)	Rear	⊖ ⊖
"43120"	FORD	Sept 01-07	(S/W) Mondeo S/Wagon	Rear	⊖ ⊖
"43124"	FIAT	06-09	Croma (generation II)	Rear	○ ○
"43133"	SMART	08-14	ForTwo all 1.0 MC cabrio 300 Brabus (W451 gen 2)	Rear	⊥ ○
"5545ST"	HONDA	Sept 16-Aug 22	 Civic Sedan (FC) 1.5, 1.8 Mk10	Rear	⊖ ⊖
"5545ST"	HONDA	Sept 16-Aug 22	 Civic Hatch (FC, FK) 1.8 300 Type R Mk10	Rear	⊖ ⊖
"5682ST"	HONDA	10-16	CR-Z Hybrid coupe (ZF1)	Rear	⊥ ⊖
"5795ST"	NISSAN	03-05	350Z (Z33)	Rear	⊥ ⊗
"5928ST" >	NISSAN	84-89	300ZX Coupe 300 elec susp & Turbo	Rear	⊥ ⊖
"5989ST"	CHRYSLER	01-10	PT Cruiser MC cabriolet	Rear	○ / ○
"71135ST" R "71136ST" !	KIA	06-12	Carens MPV (UN)	Front	
"71246ST" >	NISSAN	90-96	300ZX Coupe 300 elec susp	Front	
"71326"	HYUNDAI	00-01	Sonata (EF) gen 4	Rear	⊥ ⊖
"71326"	HYUNDAI	01 - 9/05	Sonata (EF-B) gen 4 facelift	Rear	⊥ ⊖
"71326"	KIA	04-05	Magentis 2.0, 2.5 V6 (MS)	Rear	⊥ ○
"71379ST"	MITSUBISHI	01 -06	Lancer 1.6 300 Evo (CS3A gen 8)	Rear	⊥ ⊖
"71417" >	HYUNDAI	01 - 9/05	Sonata (EF-B) gen 4 facelift	Front	⊥ ⊗
"71417" >	KIA	04-05	Magentis 2.0, 2.5 V6 (MS)	Front	
"71461" R "71462" !	NISSAN	01-03	Maxima QX (A33) & Infinity 300 elec susp	Front	
"71592"	CHRYSLER	01-10	PT Cruiser MC cabriolet	Front	
"71968ST" > R "71969ST" > !	NISSAN	95-98	200SX Coupe (S14)	Front	
"72127ST" R > / "72128ST" ! >	JEEP	19-21	Jeep Cherokee 4x2 300 Trailhawk (KL)	Front	
"72142ST"	MITSUBISHI	01 -06	Lancer 1.6 300 Evo (CS3A gen 8)	Front	
"72211ST" > R "72212ST" > !	LEXUS	03-07	RX300 XE 3.0 V6 4x4 300 air susp gen 2 (XU30)	Front	
"72211ST" > R "72212ST" > !	LEXUS	08-09	RX350 3.5 V6 4x4 300 air susp gen 2 facelift (XU30)	Front	
"72211ST" > R "72212ST" > !	TOYOTA	Feb 03-13	Harrier XU30 gen 2	Front	
"72371ST" R "72372ST" !	KIA	Mid 01 -04	Shuma II 1.5, 1.6, 1.8 (Check dates / OE # / Chassis #)	Front	
"72371ST" R "72372ST" !	KIA	01-02	Spectra 1.6	Front	
"72373ST" R "72374ST2" !	KIA	Mid 01 -04	Shuma II 1.5, 1.6, 1.8 (Check dates / OE # / Chassis #)	Rear	
"72373ST" R "72374ST2" !	KIA	01-02	Spectra 1.6	Rear	
"72495ST"	MAZDA	06-15	MX-5 (Type NC) 300 models with a btm U brkt	Front	
"72496ST"	MAZDA	06-15	MX-5 (Type NC)	Rear	⊥ ⊖
"72502ST" R "72503ST" !	TOYOTA	01-07	MR2 cabriolet	Rear	

Key

















































































- * See important installation information on inside front cover
- ! Excluding self-leveling suspension
- "..." Special order - phone 010 900 1850. 6-12 week waiting period

- ~ Imported
- # Internal bump stop
- ⊖ Steering damper

- It is recommended that all new shock absorbers are fitted in pairs
- Do not mix gas and non-gas units on the same axle
- **Bold** part numbers indicate heavy-duty shocks
- Underlined part numbers indicate parts not immediately available
- *Italic* part numbers followed by > indicate parts to be discontinued

Passenger and light commercial

Part number [numerical listing]

Part number	Make	Year	Application	Position	Mounting information
SPECIAL ORDER					
"72970ST"  "72971ST" 	HONDA	12-17	Accord Sedan 9th Gen (CR)	Front	
"72984ST"	HONDA	12-17	Accord Sedan 9th Gen (CR)	Rear	
"73125ST"  > / "73126ST" 	JEEP	14-21	Jeep Cherokee 4x4  Trailhawk (KL)	Front	
"742018SP"  "742019SP" 	BMW	04-May'10	All E61 5 Series Touring  Sedan, M5 & Sport susp)	Front	
"742020SP"  "742021SP" 	BMW	Nov'03-May'10	All E60 5 Series sedan Sport susp  Touring S/W, & M5)	Front	
"742030SP"  "742031SP" 	BMW	90-99	E36 M Tech (BMW Motorsport)	Front	
"742098SP" >	FORD	Sept'01-07	  Mondeo Sedan & Coupe  18" Wheels & Sport susp	Rear	
"742110SP"  "742111SP" 	PEUGEOT	11-14	5008 1.6 THP MPV gen 1 (T8)	Front	
"742122SP"  "742123SP" 	PEUGEOT	01-07	607 3.0 V6  elec susp)	Front	
"742124SP"	SAAB	01-10	9.5 sedan & S/W	Front	
"742158SP"	SAAB	97-'01	9.5 sedan & S/W	Front	
"742192SP"  "742193SP" 	PEUGEOT	11-18	508 sedan gen 1 (W23, 8D)	Front	
"742265SP"  "742266SP" 	CITROEN	13-17	C4 Cactus crossover SUV Bottom OE strut OD = 51mm	Front	
"742267SP"  "742268SP" 	CITROEN	13-17	C4 Cactus crossover SUV Bottom OE strut OD = 47mm	Front	
"742271SP"	SMART	14-on	ForFour 0.9 & 1.0 gen 2  Brabus (W453 gen 2)	Front	
"742271SP"	SMART	End14-on	ForTwo all 1.0  cabrio  Brabus (W453 gen 3)	Front	
"742283SP"	RENAULT	Sept 16-22	Megane IV Hatch 1.2T, 1.6,  2.0T GT & 1.8 RS)	Front	
"911173MM" >	FORD	05-09	F250 (4x2)	Front	
"911222MM" >	DODGE	03-07	Ram 2500 D 3/4 ton 4x2	Rear	
"911222MM" >	DODGE	03-06	Ram 2500 W 3/4 ton 4x4  Power wagon)	Rear	
"AU153132" >	FORD	96-Mid 99	Ranchero XR6 (XH) lowered	Rear	
"AU160369"	ISUZU	92-02	Trooper UBS 69 & UBS 26/73 series	Rear	
"AU160891"	TOYOTA	03-Oct '09	Prado J120 (5 door) / J125 (3 door) Series  elec susp) Raised +-40mm	Rear	
"AU350447" >	FORD	May'00- 02	Ranchero All AUII & AUIII  XR6 lowered)	Front	
"AU350507" >	FORD	02-08	Ranchero All BA	Front	
"AU350585"  > "AU350584"  >	FORD	96-Mid 99	Ranchero XR6 (XH) lowered	Front	
"AU350601" >	FORD	Oct '07-09	Territory 4x4 SUV (SY1)	Front	
"AU360921"	FIAT	16-on	Fiat Fullback LCV ALL 4x2 raised body & 4x4	Front	
"C1501S"	VOLVO	00-10	S60 Sedan. Gen 1 Electronic susp S60 R2.5 20v AWD Four-C	Rear	
"C1501S"	VOLVO	Feb'00-07	V70 S/Wagon Gen 2 R2.5 T AWD Elec susp  XC 4WD)	Rear	
"C1502S"	VOLVO	00-10	S60 Sedan. Gen 1 Electronic susp S60 standard  R AWD Four-C	Rear	
"C1502S"	VOLVO	98-July'06	S80 Sedan gen 1 Elec Susp Four-C. Check chassis # for correct model year	Rear	
"C1502S"	VOLVO	Feb'00-07	V70 S/Wagon Gen 2 Standard 4x2 Elec susp  XC 4WD)	Rear	
"C1503S"	VOLVO	00-10	S60 Sedan. Gen 1 Electronic susp S60 2.4 & 2.5  R2.5 AWD Four-C	Rear	
"C1503S"	VOLVO	00-July'07	XC70 SUV AWD 2.5 Cross Country S/Wagon Four-C gen 2 Elec susp	Rear	
"C1508R" / "C1509L"	MERCEDES-BENZ	5/07-May'14	W204 S/Wagon Elec Suspension	Rear	
"C1513S"	VOLVO	07-10	V70 S/Wagon Gen 3 All  Four-C AWD & Elec susp  XC 4WD)	Rear	
"C1515R" & "C1516L"	VOLKSWAGEN	08-Sept 16	Tiguan Elec Susp gen 1 (5N)	Rear	
"C1523R" & "C1524L"	VOLKSWAGEN	16 - 0n	Type VI All electronic suspension	Rear	

Key

*	See important installation information on inside front cover
!	Excluding self-levelling suspension
"..."	Special order - phone 010 900 1850. 6-12 week waiting period

~	Imported
#	Internal bump stop
⊕	Steering damper

- It is recommended that all new shock absorbers are fitted in pairs
- Do not mix gas and non-gas units on the same axle
- **Bold** part numbers indicate heavy-duty shocks
- Underlined part numbers indicate parts not immediately available
- *Italic* part numbers followed by > indicate parts to be discontinued

Passenger and light commercial

Part number [numerical listing]

Part number	Make	Year	Application	Position	Mounting information
SPECIAL ORDER					
"C1525R" / "C1526L"	MERCEDES-BENZ	Aug '11-20	SLK200, SLK250, SLK350 (R172) + '16-20 R172 facelift SLC200, SLC300 Electronic susp only EXCL AMG	Rear	⊥ ⊖
"C2501S"	VOLVO	00-10	S60 Sedan. Gen 1 R2.5 20v AWD Four-C Electronic susp	Front	⊥ ⊖
"C2501S"	VOLVO	Feb'00-07	V70 S/Wagon Gen 2 R2.5 T AWD EXCL Four-C AWD, V70 R & Elec susp	Front	⊥ ⊖
"C2502S"	VOLVO	00-10	S60 Sedan. Gen 1 Std or 2.4 & 2.5 EXCL R2.5 Electronic susp	Front	⊥ ⊖
"C2502S"	VOLVO	98-July 06	S80 Sedan gen 1 Elec Susp Four-C.	Front	⊥ ⊖
"C2502S"	VOLVO	Feb'00-07	V70 S/Wagon Gen 2 Std 4x2 or AWD EXCL Four-C AWD	Front	⊥ ⊖
"C2503S"	VOLVO	00-July 07	XC70 SUV AWD 2.5 Cross Country S/Wagon Four-C gen 2 Elec susp	Front	⊥ ⊖
"C2517R" & "C2518L"	VOLKSWAGEN	16 - 0n	Type VI All electronic suspension	Front	⊥ ⊖
"C2519R" / "C2520L"	MERCEDES-BENZ	Aug '11-20	SLK200, SLK250, SLK350 (R172) + '16-20 R172 facelift SLC200, SLC300 Electronic susp only EXCL AMG	Front	⊥ ⊖
"D0007R / D0008L"	HONDA	02-06	HR-V 4x4 1.6 (GH2) AWD & (GH1) 4x2	Front	⊥ ⊖
"D0015R / D0016L"	SUZUKI	03-04	Grand Vitara XL 4x4 gen 2 EXCL std SWB	Front	⊥ ⊖
"D0201" > "D0201S"	SUZUKI	89-99	Vitara (SWB) 2 doors 4X4 gen 1 (ET, TA)	Front	⊥ ⊖
"D0201" > "D0201S"	SUZUKI	91-99	Vitara (LWB) 4 doors 4X4 gen 1 (ET, TA)	Front	⊥ ⊖
"D2113S"	ISUZU	78-Mid 81	KB10, KA20, KA25	Front	⊥ ⊖
"D2113S"	ISUZU	Mid 81-89	KB41, KB43, KBD42 4x4	Front	⊥ ⊖
"D2113S"	ISUZU	83-86	Trooper UBS 52 series	Front	⊥ ⊖
"D2113S"	NISSAN	88- mid 99	1 Tonner 4x2 (AW) EXCL Hardbody, Hi Rider, Sani, D/Cab & Diesel (GD21)	Front	⊥ ⊖
"D2113S"	NISSAN	Mid 99-07	Hardbody 4x2 (QW) LDV EXCL Hi-Rider) D22	Front	⊥ ⊖
"D2113S"	NISSAN	08-21	NP300 4x2 LDV EXCL Hi-Rider) (D22)	Front	⊥ ⊖
"D4044" > "D4044S"	LAND ROVER	54-83	86", 88" & 107" SWB (Series I, II, IIA, IIB & III)	Rear	○ ○
"D4442S"	DAIHATSU	98-09	Feroza F300 4x4 EXCL F310)	Rear	⊥ ⊖
"D4462S"	NISSAN	88- mid 99	1 Tonner 4x4 (AW) EXCL Hardbody, Sani, D/Cab & Diesel (MD21)	Front	⊥ ⊖
"D4463S"	NISSAN	88- mid 99	1 Tonner 4x2 & 4x4 (AW) EXCL Hardbody, Hi Rider, Sani, D/Cab & Diesel (GD21)	Rear	○ ○
"D4463S"	NISSAN	Mid 99-07	Hardbody 4x2 (QW) LDV EXCL Hi-Rider) D22	Rear	○ ○
"D4463S"	NISSAN	08-21	NP300 4x2 LDV EXCL Hi-Rider) (D22)	Rear	○ ○
"D4468S"	TOYOTA	96-07	Lite Ace / Town Ace / Noah R50 AWD 	Rear	⊥ T
"D4486" > "D4486S"	NISSAN	Mid 99-07	Hardbody 4x4 only D/C (QW) LDV D22	Front	⊥ ⊖
"D4486" > "D4486S"	NISSAN	08-21	NP300 4x4 Only LDV (D22)	Front	⊥ ⊖
"D5470S"	MITSUBISHI	91- 99	Pajero 4x4 gen 2 V Series: V21, V24, V41, V44, V46 coil rear (NH, NJ, NK, NL) EXCL elec susp)	Front	⊥ ⊖
"D5471S"	MITSUBISHI	91- 99	Pajero 4x4 gen 2 V Series: V21, V24, V41, V44, V46 coil rear (NH, NJ, NK, NL) EXCL elec susp)	Rear	⊥ ⊖
"D5476" >	DAIHATSU	98-09	Rocky 4x4 F73, F78, F98	Front	⊥ ⊖
"D6415S"	LAND ROVER	54-83	86", 88" & 107" SWB (Series I, II, IIA, IIB & III)	Front	○ ○
"D6415S"	LAND ROVER	58-84	109" & 119" LWB (EXCL S/Wagon) Series II, IIA, IIB&III	Front	○ ○
"D6419" > "D6419S"	LAND ROVER	89-94	Discovery I	Front	⊥ T
"D6419" > "D6419S"	LAND ROVER	76-96	Range Rover Classic gen 1 (EXCL Air Susp.)	Front	⊥ T
"D6434S"	TOYOTA	90-93	"Grey" Import Old Prado J70 series S/W (RJ / LJ "Bundera")	Front	⊖ T
"D6435S"	TOYOTA	90-93	"Grey" Import Old Prado J70 series S/W (RJ / LJ "Bundera") EXCL 93-'96	Rear	⊖ T
"D6440" > "D6440S"	LAND ROVER	76-96	Range Rover Classic gen 1 (EXCL Air Susp.)	Rear	⊖ T
"D6440S"	LAND ROVER	89-94	Discovery I	Rear	⊖ T
"D6615S"	LAND ROVER	58-84	109" & 119" LWB (EXCL S/Wagon) Series II, IIA, IIB&III	Rear	○ T
"D6628S"	LAND ROVER	84-16	90, 110 Defender SW & 130" Double Cab LDV (L316 & L317)	Front	⊥ T

Key



- * See important installation information on inside front cover
- ! Excluding self-leveling suspension
- "..." Special order - phone 010 900 1850. 6-12 week waiting period

- ~ Imported
- # Internal bump stop
- ⊖ Steering damper

- It is recommended that all new shock absorbers are fitted in pairs
- Do not mix gas and non-gas units on the same axle
- **Bold** part numbers indicate heavy-duty shocks
- Underlined part numbers indicate parts not immediately available
- *Italic* part numbers followed by > indicate parts to be discontinued

Passenger and light commercial

Part number [numerical listing]

Part number	Make	Year	Application	Position	Mounting information
SPECIAL ORDER					
"D6629"	LAND ROVER	84-16	90, 110 Defender SW & 130" Double Cab LDV (L316 & L317)	Rear	⊖ ⊥
"D6630" > "D6630S"	MERCEDES-BENZ	79-90	G Series Gelandewagen 4x4 (W460 / W461)	Front	⊖ ⊥
"D6631" > "D6631S"	MERCEDES-BENZ	79-90	G Series Gelandewagen 4x4 (W460 / W461)	Rear	⊥ ⊖
"D6636S"	MERCEDES-BENZ	90-18	G Series Gelandewagen 4x4. 300 G55 AMG (W463)	Front	⊖ ⊥
"D6637S"	MERCEDES-BENZ	90-18	G Series Gelandewagen 4x4. 300 G55 AMG (W463)	Rear	⊥ ⊖
"D6643" >	LAND ROVER	92-96	Range Rover Classic gen 1 Air Susp	Rear	⊥ ⊥
"D7001S"	HONDA	02-06	HR-V 4x4 1.6 (GH2) AWD & (GH1) 4x2	Rear	⊥ / ⊖
"D7002" > "D7002S"	MINISUBISHI	99-07	Pajero iO (Mini) 1.6 & 1.8 Models H66W, H67W & H77W	Rear	⊖ ⊖
"D7014S"	SUZUKI	88-04	Samurai SJ413, 4X4 (Leaf spring susp)	Rear	⊖ ⊖
"D7015S"	SUZUKI	03-04	Grand Vitara XL 4x4 gen 2 300 std SWB	Rear	⊥ ⊖
"D7624S"	SUZUKI	89-99	Vitara (SWB) 2 doors 4X4 gen 1 (ET, TA)	Rear	⊥ ⊖
"D7633" > "D7633S"	SUZUKI	91-99	Vitara (LWB) 4 doors 4X4 gen 1 (ET, TA)	Rear	⊥ ⊖
"D7694S"	TOYOTA	95-98	RAV4 Type SXA 10 & 11 (300 sealed struts & 235/60R 16" wheels) gen 1	Rear	⊥ ⊖
"D7694S"	TOYOTA	98-00	RAV4 Type SXA 10 & 11 Sealed front struts 300 235/60R 16" wheels) gen 1	Rear	⊥ ⊖
"D7694S"	TOYOTA	01- Feb'06	RAV4 (ACA20,21 / ZCA 25, 26 / XA20) gen 2	Rear	⊥ ⊖
"D8003S"	NISSAN	98-02	Terrano II 3 & 5 door (R20)	Rear	⊖ ⊖
"D8004S"	ISUZU	83-86	Trooper UBS 52 series	Rear	⊖ ⊖
"D8443S"	SUZUKI	81- 87	SJ410, SJ413, SJ413-4, (leaf spring susp), 300 Samurai 4X4	Rear	⊖ ⊖
"D8465S"	DAIHATSU	98-09	Feroza F300 4x4 (300 F310)	Front	⊥ ⊖
"D8477" > "D8477S"	DAIHATSU	98-09	Rocky 4x4 F73, F78, F98	Rear	⊥ ⊖
"D8487" > "D8487S"	NISSAN	Mid 99-07	Hardbody 4x4 Hi-Rider D/C (QW) LDV D22	Rear	⊖ ⊖
"D8487" > "D8487S"	NISSAN	08-21	NP300 4x4 Hi-Rider D/C LDV (D22)	Rear	⊖ ⊖
"D8641" >	LAND ROVER	92-96	Range Rover Classic gen 1 Air Susp	Front	⊥ ⊥
"E1301" >	ROVER	01-05	75 Sedan	Rear	⊥ ⊖
"E4983" >	BMW	98-05	E46 – Sport Pack II for BMW OE Sport Susp 300 Ci	Front	⊥
"E4983" >	BMW	00-06	 325Ci, 330 Ci Coupe Sport Pac II (300 M3) (E46)	Front	⊥
"G1055A"	AUDI	05-07	  A4 Sport susp 300 Quattro, Avant & Allroad (300 S4 & RS4) B7	Rear	⊥ ⊖
"G1090A"	FIAT	13-21	Fiorino cargo panel van (327)	Rear	⊖ ⊖
"G1090A"	FIAT	13-17	Qubo mini MPV	Rear	⊖ ⊖
"G1121"	FIAT	04-10	Panda 1.3 Climbing AWD (169)	Rear	⊖ ⊖
"G1122"	DAIHATSU	03-06	Charade / Mira (L250) / Cuore (L251)	Rear	⊖ ⊖
"G1122"	DAIHATSU	03- 08	Cuore L251 gen 6 (300 L260 AWD)	Rear	⊖ ⊖
"G1125"	MINISUBISHI	07-16	Lancer 1.5, 2.0 300 Evo (CY2A gen 9)	Rear	⊥
"G1146"	DAIHATSU	05-'16	Sirion 1.3 & 1.5 hatch 4x2, 300 4x4 (M300) – Cross border = Boon	Rear	⊖ ⊖
"G1146"	DAIHATSU	05-'16	Sirion 1.3 & 1.5 hatch gen 2 4x2, 300 4x4 (M600) – Cross border = Boon	Rear	⊖ ⊖
"G1171"	FIAT	10-22	Doblo 1.6 Panorama MPV (152) & Cargo panel van (263)	Rear	⊖ ⊖
"G1183A"	RENAULT	April '13-19	Clio 1.6 RS Sport	Rear	⊥ ⊖
"G1258"	VOLVO	97- 98	S90 Sedan gen 1 300 elec or self level susp	Rear	⊖ ⊖
"G1260"	ALFA ROMEO	99-07	166 3.0 V6 & 3.2 V6 (300 2.0, 2.4, 2.5)	Front	⊥ / ⊗
"G1261"	ALFA ROMEO	99-07	166 (2.0 16v & 2.4 only from '04)	Rear	⊥ ⊖
"G1263"	FIAT	03-10	Stilo 1.6 Multi Wagon	Rear	⊖ ⊖

Key













*	See important installation information on inside front cover
!	Excluding self-levelling suspension
"..."	Special order – phone 010 900 1850, 6-12 week waiting period

~	Imported
#	Internal bump stop
⊖	Steering damper

- It is recommended that all new shock absorbers are fitted in pairs
- Do not mix gas and non-gas units on the same axle
- **Bold** part numbers indicate heavy-duty shocks
- Underlined part numbers indicate parts not immediately available
- *Italic* part numbers followed by > indicate parts to be discontinued

Passenger and light commercial

Part number [numerical listing]

Part number	Make	Year	Application	Position	Mounting information
SPECIAL ORDER					
"G1263"	FIAT	03-10	Stilo 1.9 JTD Multi Wagon	Rear	⊖ ⊖
"G1308"	SAAB	94-98	900 Sedan & Convertible MC turbo	Rear	⊥ ⊖
"G1308"	SAAB	98-'02	 9.3 2.0 & 2.2TiD sedan & coupe MC Turbo	Rear	⊥ ⊖
"G1308"	SAAB	98-'02	 9.3 Convertible	Rear	⊥ ⊖
"G1316"	HONDA	03-08	Accord Sedan EX Type-R, ABS & S/W) 7th Gen (CM)	Rear	⊥ ○
"G1318"	TOYOTA	02-09	Ipsum / Picnic / Avensis Verso 7 seater MPV (XM20)	Rear	⊥ ○
"G1319"	TOYOTA	00-05	Previa 2.0 D 4-D, 2.4, 3.0 V6 (4x2) (gen 2 XR30, XR40)	Rear	⊥ ○
"G1323"	HONDA	03-08	Accord Sedan EX Type-R, ABS & S/W) 7th Gen (CM)	Front	⊥ ⊗
"G1323"	HONDA	03-09	Accord S/Wagon 7th Gen (EX ABS & sport susp) (CM)	Front	⊥ ⊗
"G1324"	HONDA	03-09	Accord S/Wagon 7th Gen (EX ABS & sport susp) (CM)	Rear	⊥ ○
"G1338"	RENAULT	Sept'04-end 09	Grand Scenic II (LWB) 1.9dCi, 2.0	Rear	⊖ ●
"G1338"	RENAULT	end 09-16	Grand Scenic III (LWB) 1.9dCi	Rear	⊖ ●
"G1343"	ALFA ROMEO	05-11	159	Rear	⊥ ○
"G1362"	AUDI	Dec '00- 04	 +  A4 Sedan and Avant Sport Suspension MC Quattro sport EX S4 & RS4) B6, 8E	Rear	⊥ ⊖
"G1363"	RENAULT	02 - 14	Espace + Grand Espace 2.0, 2.2dCi, 3.5 V6 MPV	Rear	⊖ ⊖
"G1365"	BMW	90-99	E36 M Tech (BMW Motorsport)	Rear	⊗ ⊖
"G1368"	AUDI	98-April '03	A3 Sport Susp (EX Quattro)	Rear	⊥ ⊖
"G1369"	ROVER	01-05	75 Sedan	Rear	⊥ ○
"G1369"	ROVER	01-05	75 Sedan	Rear	⊥ ○
"G1371"	SAAB	03-10	 9.3 Sedan 1.9TiD, 2.0 and 2.0T MC Convertible	Rear	⊥ ⊖
"G16161" R "G16162" L	TOYOTA	89-94	Starlet EP80, EP81, EP82, NP80	Front	⏏
"G16161" R "G16162" L	TOYOTA	94-96	Starlet EP80, EP81, EP82, NP80	Front	⏏
"G16251" R "G16252" L	TOYOTA	96-00	Starlet EP91	Front	⏏
"G16259"	RENAULT	96- June'98	Scenic 1.6 Automatic, 1.9dCi, 2.0 (EX RX4)	Front	⏏
"G16329" R "G16330" L	OPEL	05 - 09	Tigra 1.4, 1.8 TwinTop Cabriolet	Front	⏏
"G16331" R "G16332" L	KIA	00-05	Carens MPV (FC / RS)	Rear	⏏
"G16331" R "G16332" L	KIA	97-'Jan99	Shuma I 1.5, 1.6, 1.8 (Check date / OE#) EX Chassis #'s FBFSR6# & FBFDR6# EX front Stabiliser bar	Rear	⏏
"G16331" R "G16332" L	KIA	Feb'99-mid 01	Shuma I 1.5, 1.6, 1.8 (Check dates / chassis #) With Stabiliser bar, EX Chassis #'s FBFSR6# & FBFDR6#	Rear	⏏
"G16341" R "G16342" L	KIA	97-'Jan99	Shuma I 1.5, 1.6, 1.8 (Check date / OE#) EX Chassis #'s FBFSR6# & FBFDR6# EX front Stabiliser bar	Front	⏏
"G16356"	FIAT	02-10	Palio II Weekend S/Wagon Type 2G & 2K 1.4 (EX 2K 1.6)	Front	⏏
"G16422" R "G16423" L	CITROEN	01-05	Xsara II (1.6, 2.0 & 2.0d)	Front	⏏
"G16422" R "G16423" L	PEUGEOT	93-97	 306 CC Cabrio	Front	⏏
"G1646"	ALFA ROMEO	06-10	Brera 2.2 JTS & 3.2 V6	Rear	⊥ ○
"G16479" R "G16480" L	SUBARU	92-01	  Impreza 1 AWD 1.8 & 2.0 (EX Air susp, GT Turbo Sport/ WRX Sti and Outback) (GC/GF/GM/GFC)	Front	⏏
"G16479" R "G16480" L	SUBARU	94-96	  Legacy II 4x4 (EX Air susp, 3.0 & Outback) (BD/BG/BK)	Front	⏏
"G16479" R "G16480" L	SUBARU	96-99	  Legacy II Facelift 4x4 (EX Air susp, 3.0 & Outback) (BD/BG/BK)	Front	⏏
"G16598"	ALFA ROMEO	94- June 01	145 & 146 1.4TS, 1.6TS, 1.8TS, 1.9TDS & 2.0 TS	Front	⏏
"G16598"	ALFA ROMEO	91- 97	155 (EX 2500 V6, 2.5TD, 2.0 Turbo AWD, elec susp)	Front	⏏

Key

- * See important installation information on inside front cover
- ! Excluding self-levelling suspension
- "..." Special order - phone 010 900 1850. 6-12 week waiting period

- ~ Imported
- # Internal bump stop
- ⊖ Steering damper

- It is recommended that all new shock absorbers are fitted in pairs
- Do not mix gas and non-gas units on the same axle
- **Bold** part numbers indicate heavy-duty shocks
- Underlined part numbers indicate parts not immediately available
- *Italic* part numbers followed by > indicate parts to be discontinued

Passenger and light commercial

Part number [numerical listing]

Part number	Make	Year	Application	Position	Mounting information
SPECIAL ORDER					
"G16657"	OPEL	01-06	Omega 2.2Dti, 2.5 all, 2.6, 3.0, 3.2 [EXC] S/Wagon) (V94)	Front	
"G16672"	FORD	98-Sept'01	Mondeo 1.8,2.0 & 2.5 Si sedan	Rear	
"G16701" R "G16702" L	SUBARU	92-01	Impreza 1 AWD 1.8 & 2.0 [EXC] Air susp, GT Turbo Sport/ WRX.Sti and Outback) (GC/GF/GM/GFC)	Rear	
"G16701" R "G16702" L	SUBARU	92-93	Legacy I 4x4 [EXC] Air susp) (BC/BF/BJ)	Rear	
"G16701" R "G16702" L	SUBARU	94-96	Legacy II 4x4 [EXC] Air susp, 3.0 & Outback) (BD/BG/BK)	Rear	
"G16728"	RENAULT	96-'02	Espace (J66 / P52) + Grand Espace (D66) MPV [EXC] air susp	Front	
"G16732" R "G16733" L	TOYOTA	95-'01	Ipsium / Picnic 7 seater MPV (XM10)	Front	
"G2123"	TOYOTA	04-March '09	Prius Hybrid (NHW20, XW20) gen 2	Rear	
"G2132"	SUBARU	05-09	Legacy Outback 2.5, 3.0 AWD (BP) gen 3 [EXC] Self leveling or elec susp	Rear	
"G21632"	VOLVO	94- 96	850 Sedan & S/Wagon [EXC] Lowered and Nivomat self leveling suspension) (OE springs x 2 must also be used)	Rear	
"G21632"	VOLVO	97-05	C70 Coupe & Cabrio (OE springs x 2 must also be used)	Rear	
"G21632"	VOLVO	97- Feb'00	V70 S/Wagon Gen1 [EXC] Elec Four-C & Nivomat rears)	Rear	
"G21632"	VOLVO	97-'00	S70 Sedan [EXC] lowerered & Nivomat leveling suspension (OE springs x 2 must be used)	Rear	
"G2175"	NISSAN	14-17	Leaf (ZE0)	Rear	
"G2175"	NISSAN	18-23	Leaf (ZE1)	Rear	
"G2226"	CITROEN	08-12	C4 Picasso MPV [EXC] air susp	Rear	
"G2237"	PEUGEOT	97-Feb'06	406 Coupe 3.0 [EXC] elec susp)	Rear	
"G2243"	ALFA ROMEO	05-11	159	Front	
"G2243"	ALFA ROMEO	06-10	Brera 2.2 JTS & 3.2 V6	Front	
"G2247"	FIAT	02-06	Ulysse MPV	Rear	
"G2247"	PEUGEOT	03-08	807 MPV 2.2 Hdi	Rear	
"G2248"	AUDI	Dec '00- 04	A4 Sedan and Avant Sport Suspension [EXC] Quattro sport [EXC] S4 & RS4) B6, 8E	Front	
"G2248"	AUDI	05-07	A4 Sport susp [EXC] Quattro, Avant & Allroad [EXC] S4 & RS4) B7	Front	
"G2248"	AUDI	02-08	A4 Cabriolet [EXC] Sport susp	Front	
"G2249"	PEUGEOT	March '04-10	307 CC Cabrio	Rear	
"G2251"	AUDI	95- Jan'99	A4 Quattro Sedan [EXC] Sport,) 8D, B5	Rear	
"G2251"	AUDI	Feb'99-Nov'00	A4 Quattro [EXC] S4) B5, 8D	Rear	
"G2252"	AUDI	Feb'99-Nov'00	A4 Avant Quattro [EXC] S4 & Sport suspension)	Rear	
"G2252"	AUDI	Feb'99-Nov'00	A4 Sport Quattro [EXC] S4) B5, 8D	Rear	
"G22563"	FIAT	69-79	(S/W) 124 S/Wagon	Rear	
"G22691" >	TOYOTA	90-00	Previa std & GL (ABS) Rear IRS TCR 11 & 21 (gen 1 XR10, XR20)	Rear	
"G23940"	HONDA	99-02	Accord Sedan [EXC] Type-R) 6th Gen (CK, CG, CH, CF)	Front	
"G2508"	FIAT	11-22	Panda 0.9, 1.2 Climbing / Cross AWD [EXC] 1.4 100HP) (319) mk4	Rear	
"G2552"	VOLVO	17-23	S90 Sedan gen 2 [EXC] elec or self level susp	Rear	
"G43143"	MERCEDES-BENZ	94- Aug '00	All Sport Suspension, [EXC] C250td, C280 & S/W (W202)	Front	
"G43146"	MERCEDES-BENZ	94- Aug '00	All Sport Suspension, [EXC] C250td, C280 & S/W (W202)	Rear	
"G43147"	JAGUAR	End 94-09	XJ6, XJ12, Daimler & Double six (X300 Series) [EXC] XJR	Front	
"G43153"	CHEVROLET	10/03-05	Vivante MPV (Was Tacuma)	Rear	
"G43153"	DAEWOO	01-'03	Tacuma MPV	Rear	
"G43155"	MERCEDES-BENZ	19-22	CLS300, CLS350, CLS5400 (W257) [EXC] AMG)	Rear	

Key

*	See important installation information on inside front cover
!	Excluding self-leveling suspension
"..."	Special order - phone 010 900 1850. 6-12 week waiting period

~	Imported
#	Internal bump stop
⊕	Steering damper

- It is recommended that all new shock absorbers are fitted in pairs
- Do not mix gas and non-gas units on the same axle
- **Bold** part numbers indicate heavy-duty shocks
- Underlined part numbers indicate parts not immediately available
- *Italic* part numbers followed by > indicate parts to be discontinued

Passenger and light commercial

Part number [numerical listing]

Part number	Make	Year	Application	Position	Mounting information
SPECIAL ORDER					
"643158"	MERCEDES-BENZ	19-22	CLS300, CLS350, CLS5400 (W257) 300 AMG	Front	⊥ ⊗
"652020"	FORD	98- Sept'01	(S/W) Mondeo 2.0 S/Wagon	Rear	⊖ ⊖
"652023"	RENAULT	99-01	Laguna Sedan (B56 / K56) Check front mounting information for correct strut Shock OE#'s 7700830490 = 11743	Rear	⊖ ⊗
"652024"	RENAULT	95- 00	Laguna S/Wagon (B56 / K56)	Rear	⊖ ⊖
"655008"	JAGUAR	86-End 94	XJ6, XJ12 Daimler Sovereign & Double Six (XJ40 Series)	Rear	⊥ ⊖
"655015"	AUDI	92-'01	80 / 100 / 500 Cabriolet	Rear	⊥ ⊖
"655026"	JAGUAR	End 94-09	XJ6, XJ12, Daimler & Double six (X300 Series) 200 XJR	Rear	⊥ ⊗
"655026"	JAGUAR	97-03	XJ8 (X308 series) 2+2	Rear	⊥ ⊖
"67201" R "67202" I	NISSAN	01-'03	 Almera / Sunny Hatch (N16E)	Front	
"67281"	RENAULT	01-07	Laguna II All, 100 S/Wagon (X74) – Angled S/Seat	Front	
"67301" R "67302" I	FORD	05-09	Ka 1.3 Hatch	Front	
"67309" R "67308" I	NISSAN	06-12	Note hatch (Cross border markets)	Front	
"67312" R "67313" I	KIA	04-July'09	Cerato / Spectra 1.6 & 2.0, (LD) gen 1	Rear	
"67314" R "67315" I	KIA	04-July'09	Cerato / Spectra 1.6 & 2.0, (LD) gen 1	Front	
"67327" R "67328" I	CITROEN	08-12	C4 Picasso MPV 100 air susp	Front	
"67373"	RENAULT	13-Sept '18	Duster 4x4 1.6, 1.5dci (Auto) gen 1 (HS)	Front	
"67507" R "67508" I	TOYOTA	04-March '09	Prius Hybrid (NHW20, XW20) gen 2	Front	
"68093" R "68094" I	HYUNDAI	01-08	Trajet 2.0d & 2.7 MPV (F0)	Front	
"68107" R "68108" I	FIAT	13-21	Fiorino cargo panel van (327)	Front	
"68107" R "68108" I	FIAT	13-17	Qubo mini MPV	Front	
"68137" R "68138" I	MITSUBISHI	07-16	Lancer 1.5, 2.0 200 Evo (CY2A gen 9)	Front	
"68165" R "68166" I	KIA	09-12	Cee'd hatch 2.0 3-door (ED)	Front	
"68167" R "68168" I	CITROEN	11-16	Dispatch Multispace Minibus & panel van	Front	
"68167" R "68168" I	FIAT	08-16	Scudo 7 seater (gen 2)	Front	
"68167" R "68168" I	PEUGEOT	09-14	Expert Panel Van 2.0 Hdi I 100 Tepee MPV gen 2	Front	
"68174" R "68175" I	FIAT	04-10	Panda 1.3 Climbing AWD (169)	Front	
"68186"	RENAULT	09-14	Laguna III Coupe (X91)	Front	
"68208" R "68209" I	FIAT	10-22	Doblo 1.6 Panorama MPV (152) & Cargo panel van (263)	Front	
"68250" R "68251" I	TOYOTA	April '09-May'16	Prius Hybrid (ZWW30, XW30) gen 3	Front	
"68267"	RENAULT	11-17	Fluence sedan	Front	
"68284" R "68285" I	FIAT	11-22	Panda 0.9, 1.2 Climbing / Cross AWD 200 1.4 100HP) (319) mk4	Front	
"68290" R "68291" I	SAAB	03-10	 9.3 Sedan 1.9TiD, 2.0 and 2.0T 100 Convertible	Front	
"68320"	FIAT	03-10	Stilo 2.4 Abarth Hatch	Front	
"68322"	VOLVO	94-96	960 Sedan & S/Wagon (Leaf spring susp) 200 coil rear suspension	Front	
"68322"	VOLVO	97- 98	S90 Sedan gen 1 200 elec or self level susp	Front	
"68322"	VOLVO	97- 98	V90 S/Wagon 200 XC90 4WD Cross Country	Front	

Key

*	See important installation information on inside front cover
!	Excluding self-leveling suspension
"..."	Special order – phone 010 900 1850. 6-12 week waiting period

~	Imported
#	Internal bump stop
⊖	Steering damper

- It is recommended that all new shock absorbers are fitted in pairs
- Do not mix gas and non-gas units on the same axle
- **Bold** part numbers indicate heavy-duty shocks
- Underlined part numbers indicate parts not immediately available
- *Italic* part numbers followed by > indicate parts to be discontinued

Passenger and light commercial

Part number [numerical listing]

Part number	Make	Year	Application	Position	Mounting information
SPECIAL ORDER					
"G8326"	SAAB	94-98	900 Sedan & Convertible MC turbo	Front	
"G8350"	ALFA ROMEO	97-05	156 GTA & Sport Susp EXC 3.2 GTA)	Rear	
"G8350" >	ALFA ROMEO	05-10	3.2 V6 GTA	Rear	
"G8378"	AUDI	99-April '03	A3 Quattro (MC Sport Susp)	Front	
"G8388"	AUDI	May 03-12	A3 & S3 Quattro and sport suspension 2.0 & 3.2 : 55mm OD strut only (EXC S3 front & all RS3)	Front	
"G8397"	RENAULT	02 - 14	Espace + Grand Espace 2.0, 2.2dCi, 3.5 V6 MPV	Front	
"G8399"	SEAT	06-10	Altea Mini MPV OE Strut leg outer diam = 55mm	Front	
"G8399"	SEAT	06-08	Leon Hatch EXC Cupra & Sport susp) OE Strut leg outer diam = 55mm	Front	
"G8401" R "G8402" L	KIA	04 - April '07	Sedona MPV gen 1 (GQ / KV)	Front	
"G8401" R > / "G8402" L >	KIA	99-04	Carnival MPV (KV-II / UP) gen 1	Front	
"G8601" R "G8602" L	FIAT	02-06	Ulysse MPV	Front	
"G8601" R "G8602" L	PEUGEOT	03-08	807 MPV 2.2 Hdi	Front	
"G8617"	ALFA ROMEO	05-10	2.0 & 1.9JTD EXC 3.2 V6 GTA	Rear	
"G8618"	AUDI	00-April '03	S3 Quattro (EXC sport)	Front	
"G8619" R "G8620" L	ROVER	01-05	75 Sedan	Front	
"G8821" R "G8822" L	MERCEDES-BENZ	Oct '15 - on	V Class 7 seater MPV minibus AWD only (W447 Gen 3) EXC RWD	Front	
"G9511" R "G9512" L	SUZUKI	09-15	Alto hatch 1.0 gen 7 (GF)	Front	
"MG247"	OPEL	92- 98	Calibra 2.0 16v & 2.5 V6 (EXC Turbo)	Front	
"MG259"	OPEL	93- Oct '99	Kadett & Astra (MC S/W) (F) (Firm ride)	Front	
"MG278"	SAAB	98-'02	9.3 2.0 & 2.2TiD sedan & coupe MC Turbo	Front	
"MG278"	SAAB	98-'02	9.3 Convertible	Front	
"MG312" >	BMW	Mid 90 - 95	5 Series (E34) Std. & Sport Susp EXC M Tech & M5) (14mm rod OD & long "neck")	Front	
"MG971"	BMW	74-75	518, 520 (E12)	Front	
"MG971"	BMW	74-76	525, 528 (E12) - MC 518, 520 '76 model only	Front	
"MG971"	BMW	77-Mid 85	518, 520, 525, 528 (E12)	Front	
"MG971"	BMW	6/78 - 5/82	628CSi, 630CSi, 633CSi, 635CSi (E24)	Front	
"MG971"	BMW	78-87	728, 730, 733, 735 (E23)	Front	
"MG971"	BMW	84-86	745i (E23)	Front	
"MR205"	PEUGEOT	80-85	504 S/Wagon (Local Strut)	Front	
"MR904"	PEUGEOT	60-79	404 Sedan	Front	
"MR904"	PEUGEOT	65-79	(S/W) 404 S/Wagon	Front	
"MR904"	PEUGEOT	60-81	 404 LDV	Front	
"MR916"	PEUGEOT	70-85	504 Sedan (EXC 1800L)	Front	
"MR916"	PEUGEOT	76-85	504 Sedan 1800L	Front	
"MR916"	PEUGEOT	74-80	504 S/Wagon (Imported Strut)	Front	
"MR967"	AUDI	92-'01	80 / 100 / 500 Cabriolet	Front	
"MR969"	PORSCHE	76-88	924 Turbo, Carrera GT & S (EXC sealed struts)	Front	
"MR969"	PORSCHE	81-88	944 MC Turbo (EXC sealed struts)	Front	
"MR999"	PEUGEOT	80-85	505 Sedan (Local Strut)	Front	
"R11002"	FIAT	74-84	131 All	Front	

Key

*	See important installation information on inside front cover
!	Excluding self-levelling suspension
"..."	Special order - phone 010 900 1850. 6-12 week waiting period

~	Imported
#	Internal bump stop
⊕	Steering damper

- It is recommended that all new shock absorbers are fitted in pairs
- Do not mix gas and non-gas units on the same axle
- **Bold** part numbers indicate heavy-duty shocks
- Underlined part numbers indicate parts not immediately available
- *Italic* part numbers followed by > indicate parts to be discontinued

Passenger and light commercial

Part number [numerical listing]

Part number	Make	Year	Application	Position	Mounting information
SPECIAL ORDER					
"R11003"	FIAT	71-84	128 All	Front	
"R11004"	FIAT	71-84	128 All	Rear	
"R11172"	RENAULT	96-00	Safrane	Rear	
"R11357"	KIA	97-00	Pride	Front	
"R11358"					
"R1545"	VOLKSWAGEN	68-80	Kombi, Microbus Type II Steering Damper ⊕	Front	○ ○
"R1549"	ALFA ROMEO	66-77	Giulia 1300, 1600, 1750, 2000 & Super T.I. Berlina & Coupe	Front	⊥ ○
"R1549"	ALFA ROMEO	68-81	Spider 1.3, 1.6, 1750 & 2.0 Junior & Veloce	Front	⊥ ○
"R1646A"	MG	95-01	MGF	Front	⊥ ○
"R1647"	MG	95-01	MGF	Rear	⊥ ○
"R2554"	ALFA ROMEO	66-77	Giulia 1300, 1600, 1750, 2000 & Super T.I. Berlina & Coupe	Rear	⊥ T
"R2554"	ALFA ROMEO	68-81	Spider 1.3, 1.6, 1750 & 2.0 Junior & Veloce	Rear	⊥ T
"R2559"	FIAT	69-79	124 Sedan	Front	⊥ ○
"R2559"	FIAT	69-79	(S/W) 124 S/Wagon	Front	⊥ ○
"R2578"	VOLKSWAGEN	65 - 03	Beetle (Type 1) Imported, Mexico	Front	⊥ ⊕
"R3216"	CHEVROLET	69-72	Constantia & Kommando	Rear	⊥ ○
"R3216"	CHEVROLET	72-79	(S/W) Constantia, Kommando & De Ville Sedan & S/Wagon	Rear	⊥ ○
"R3216"	CHEVROLET	68-72	El Camino	Rear	⊥ ○
"R3216"	HOLDEN	65-71	All (Monaro G.T.S.)	Rear	⊥ ○
"R3216"	OPEL	67-73	Rekord 4 Cylinder	Rear	⊥ ○
"R3216" ~	RANGER	68-73	Sedan All	Rear	⊥ ○
"R3242"	VOLVO	72-74	144 & 164 (Will also fit '66-71 models)	Rear	⊕ ○
"R3248"	RENAULT	74-85	R5 All	Front	⊥ ⊕
"R3256"	LAND ROVER	54-83	86", 88" & 107" SWB (Series I, II, IIA, IIB & III) Steering Damper ⊕	Front	⊥ T
"R3256"	LAND ROVER	95-98	Discovery I Steering Damper ⊕	Front	⊥ T
"R3256"	LAND ROVER	76-96	Range Rover Classic gen 1 Air Susp.) Steering Damper ⊕	Front	⊥ T
"R3256"	LAND ROVER	92-96	Range Rover Classic gen 1 Air Susp Steering Damper ⊕	Front	⊥ T
"R3256"	LAND ROVER	58-84	109" & 119" LWB (S/Wagon) Series II, IIA, IIB&III Steering Damper ⊕	Front	⊥ T
"R3256"	LAND ROVER	89-94	Discovery I Steering Damper ⊕	Front	⊥ T
"R3274"	FIAT	69-79	124 Sedan	Rear	⊥ ○
"R3274"	FIAT	74-84	131 All	Rear	⊥ ○
"R3425"	OPEL	01-06	Omega 2.2Dti, 2.5 all, 2.6, 3.0, 3.2 S/Wagon) (V94)	Rear	⊕ ⊕
"R3445"	NISSAN	92-03	Micra (K11) cross border applications gen2	Rear	⊥ ○
"R3464"	MITSUBISHI	95-07	Space Gear 2.4 GLX leaf rear coil spring susp) (L400) PA3W, PA4W, PA5W	Front	⊥ ⊕
"R3724"	RENAULT	Mid 83-86	R9 & R11 All	Rear	⊥ ⊕
"R3738"	AUDI	75-Mid 81	80 Sedan & S/Wagon	Rear	⊥ ⊕
"R3741"	RENAULT	74-85	R5 All	Rear	⊥ ⊕
"R3897"	KIA	97-00	Pride	Rear	⊥ ⊕
"R5410"	PEUGEOT	76-85	504 Sedan 1800L	Rear	⊥ T
"R5410"	RAMBLER	70-76	Hornet & Sportabout	Rear	⊥ T
"R5410"	PEUGEOT	60-79	404 Sedan	Rear	⊥ T
"R5418"	PEUGEOT	70-85	504 Sedan 1800L	Rear	⊥ ⊕

Key





* See important installation information on inside front cover
! Excluding self-leveling suspension
"..." Special order - phone 010 900 1850. 6-12 week waiting period

~ Imported
Internal bump stop
⊕ Steering damper

- It is recommended that all new shock absorbers are fitted in pairs
- Do not mix gas and non-gas units on the same axle
- **Bold** part numbers indicate heavy-duty shocks
- Underlined part numbers indicate parts not immediately available
- *Italic* part numbers followed by > indicate parts to be discontinued

Passenger and light commercial

Part number [numerical listing]

Part number	Make	Year	Application	Position	Mounting information
SPECIAL ORDER					
"R5418"	PEUGEOT	80-85	505 Sedan (Local Strut)	Rear	⊥ ⊕
"R5433"	PEUGEOT	60-81	 404 LDV	Rear	⊕ ⊕
"R6335"	AUDI	83-94	400, 500 [Exc] Quattro, sport susp & S4)	Rear	⊥ ⊕
"R6335"	AUDI	94-July'97	A6 Sedan & Avant [Exc] Quattro, Sport susp., & S6)	Rear	⊥ ⊕
"R8001" [R] "R8002" [L]	PEUGEOT	98-02	306 Hatch, 1.6 Sedan and S/Wagon	Front	
"R8001" [R] "R8002" [L]	PEUGEOT	97-2/04	 306 CC Cabrio	Front	
"RS55021C"	ISUZU	April '13-'21	KB / D-Max 4x4 P190 / RT50 / RT85 & 4x2 Hi-Rider raised body RT series Raised 50mm	Rear	○ ○
"RS55118A >"	MITSUBISHI	07-16	Triton LDV All 4x4 & 4x2 raised body Std height gen 4 (MN) Raised +-30mm	Rear	○ ○
"RS55210A"	TOYOTA	90-98	Landcruiser 80 series S/Wagon ([Exc] certain solid axle 105 series '98-'07 models) Raised +-50mm	Front	⊥ T
"RS55211" >	NISSAN	98-17	Patrol S/W 4x4 GR I / GU I Y61 Series Raised 50mm (Coil springs) [Exc] '02-on 3.0TDi & 4.8i GR II / GU II series Raised 50mm	Front	⊥ T
"RS55212B"	TOYOTA	90-98	Landcruiser 80 series S/Wagon ([Exc] certain solid axle 105 series '98-'07 models) Raised +-50mm	Rear	⊥ ⊕
"RS55302"	TOYOTA	Nov '09-Q1 '24	Prado J150 [Exc] elec susp) 3.0 GRJ150, 4.0 KDJ150 Raised +-40mm	Rear	⊥ ○
"RS55779B"	ISUZU	April '13-'21	KB / D-Max 4x4 P190 / RT50 / RT85 & 4x2 Hi-Rider raised body RT series Raised 30mm to 60mm	Front	⊥ ○
"RS55783B"	TOYOTA	Nov '09-Q1 '24	Prado J150 [Exc] elec susp) 3.0 GRJ150, 4.0 KDJ150 Raised +-40mm	Front	⊥ ⊕
"RS55787A"	NISSAN	05-March 17	Navara 4x2 & 4x4 LDV (D40) Raised +-30mm	Front	⊥ ⊕
"RS999118" >	JEEP	86- 96	Jeep Wrangler 4x4 (YJ series) Raised 63mm	Rear	○ ⊕
"RS999129"	JEEP	91- 01	Jeep Cherokee 4x4 [Exc] Sport, Limited & Country (XJ) Std ht	Rear	⊕ ○
"RS999168" >	JEEP	86- 96	Jeep Wrangler 4x4 (YJ series) Std Height	Front	⊥ ⊕
"RS999168" >	JEEP	86- 96	Jeep Wrangler 4x4 (YJ series) Raised 63mm	Front	⊥ ⊕
"RS999194" >	JEEP	93- 98	Jeep Grand Cherokee All (ZJ series) ([Exc] Up- country Susp) Raised 76mm	Rear	○ ⊕
"RS999360"	LAND ROVER	99- end 04	Discovery 2 [Exc] Active ride control (L318)	Front	⊕ ⊕
"SC2959" >	NISSAN	89- 97	Patrol S/W 4x4 G0 / GR Y60 Series (Coil springs) Steering Damper ⊕	Front	⊥ T
"SC2974"	JEEP	18-on	Jeep Wrangler (JL series) Steering Damper ⊕	Front	⊕ ⊕
"V1056"	IVECO	All up till '89	30.8, 35.8, 35.10, 40.8, 40.10, 45.10, 49.10 (Check OE numbers)	Rear	⊕ ⊕
"V1079"	IVECO	All up till '89	30.8, 35.8, 35.10, 40.8, 40.10, 45.10, 49.10 (Check OE numbers)	Front	⊕ ⊕
"V1102"	IVECO	89-99	30.8, 35.8, 35.10, 40.8 Leaf spring rear (Check OE numbers)	Front	⊕ ⊕
"V1102"	IVECO	89-99	35.8, 35.10, 40.10 Leaf spring rear Chassis #'s 5973717 -> on (Check OE numbers)	Front	⊕ ⊕
"V1102"	IVECO	89- 99	Turbo Daily 30.10, 35.10, 35.12 Leaf spring rear (check OE numbers)	Front	⊕ ⊕
"V1102"	IVECO	89-99	Turbo Daily 35.10, 35.12, 40.10, 40.12 Leaf spring rear. Chassis #'s 5973717 -> on (Check OE numbers)	Front	⊕ ⊕
"V1103"	IVECO	89-99	30.8, 35.8, 35.10, 40.8 Leaf spring rear (Check OE numbers)	Rear	⊕ ⊕
"V1103"	IVECO	89- 99	Turbo Daily 30.10, 35.10, 35.12 Leaf spring rear (check OE numbers)	Rear	⊕ ⊕
"V1103"	IVECO	89-99	Turbo Daily 45.10, 45.12, 49.10, 49.12 (Check OE numbers)	Rear	⊕ ⊕
"V1108"	TOYOTA	95-99	Regius / Hi-Ace 4x2 RCH12, RCH13, LKH12	Front	⊥ ⊕
"V1140"	TOYOTA	95-99	Regius / Hi-Ace 4x2 RCH12, RCH13, LKH12	Rear	○ T
"V1172"	IVECO	90-99	Turbo Daily 59.12	Front	⊕ ⊕
"V1202"	MERCEDES-BENZ	06-18	Sprinter 3 ton and 3.5 ton [Exc] 4x4 gen 2 (B906) – models with heavy duty suspension OE#'s 9063200431 & 9063201031 (length: closed 348mm & open 546mm)	Rear	⊕ ⊕
"V1203"	MERCEDES-BENZ	06-18	Sprinter 3 ton and 3.5 ton 4x4 Only gen 2 (B906)	Rear	⊕ ⊕
"V1205"	MERCEDES-BENZ	96-05	Sprinter van / bus. B901, B902 = 200 series, B903 = 300 series & B904 = 400 series. Gen 1 NB: – models with 16" rims and heavy duty suspension (length: closed 348mm & open 546mm) OE # 9013200831	Rear	⊕ ⊕
"V2111"	IVECO	90-99	Turbo Daily 59.12	Rear	⊕ ⊕

Key

*	See important installation information on inside front cover
!	Excluding self-levelling suspension
"..."	Special order – phone 010 900 1850. 6-12 week waiting period

~	Imported
#	Internal bump stop
⊕	Steering damper

- It is recommended that all new shock absorbers are fitted in pairs
- Do not mix gas and non-gas units on the same axle
- **Bold** part numbers indicate heavy-duty shocks
- Underlined part numbers indicate parts not immediately available
- *Italic* part numbers followed by > indicate parts to be discontinued

Passenger and light commercial

Part number [numerical listing]

Part number	Make	Year	Application	Position	Mounting information
SPECIAL ORDER					
"V2506"	FIAT	02-June'06	 Ducato 10, 14 Van 2.3JTD, 2.8JTD – 1.0 ton ton Gen 2	Rear	⊖ ⊖
"V2510"	FIAT	Sept'97-02	Ulysse MPV	Rear	⊖ ⊖
"V2510"	PEUGEOT	Oct '97-'02	806 MPV	Rear	⊖ ⊖
"V2512"	NISSAN	07-'10	Interstar van & taxi (Air susp)	Rear	○ ○
"V2512"	OPEL	98-12	Movano Van Mk1 (leaf spring pick-up & air spring van) (X70)	Rear	⊖ ⊖
"V2517"	CITROEN	11-16	Dispatch Multispace Minibus & panel van	Rear	○ ○
"V2517"	FIAT	08-16	Scudo 7 seater (gen 2)	Rear	○ ○
"V2517"	PEUGEOT	09-14	Expert Panel Van 2.0 Hdi I  Tepee MPV gen 2	Rear	○ ○
"V4001"  "V4002" 	SUZUKI	85-0n	Carry "1/2 Loaf" SK 408, SK410	Front	
"V4201"	FIAT	94- Aug '97	Ulysse MPV	Front	
"V4201"	FIAT	Sept'97-02	Ulysse MPV	Front	
"V4201"	PEUGEOT	96- Sept'97	806 MPV	Front	
"V4201"	PEUGEOT	Oct '97-'02	806 MPV	Front	
"V5006"	FIAT	94- Aug '97	Ulysse MPV	Rear	⊖ ⊖
"V5006"	PEUGEOT	96- Sept'97	806 MPV	Rear	⊖ ⊖
"376126SP"	SAAB	97-'01	9.5 sedan & S/W	Rear	⊥ ⊖
"376126SP"	SAAB	01-10	9.5 sedan & S/W	Rear	⊥ ⊖

Key

*	See important installation information on inside front cover
!	Excluding self-levelling suspension
"..."	Special order – phone 010 900 1850. 6-12 week waiting period

~	Imported
#	Internal bump stop
⊕	Steering damper

- It is recommended that all new shock absorbers are fitted in pairs
- Do not mix gas and non-gas units on the same axle
- **Bold** part numbers indicate heavy-duty shocks
- Underlined part numbers indicate parts not immediately available
- *Italic* part numbers followed by > indicate parts to be discontinued

Truck, bus and trailer

Part number [numerical listing]

Part number	Make	Year	Application	Position	Mounting information
65103	FREIGHTLINER	All	Freightliner Trucks: FLA, FLB COE truck & tractor, FLC112, FLD112, FLD120	Front	○ ○
65103	FREIGHTLINER	All	Freightliner Trucks: MB/FL 50, 60, 70, 80, FC70, FC80, Cargo, Classic, Classic XL class, Coronada class, Lagacy class.	Front	○ ○
65103	FREIGHTLINER	All	Freightliner Trucks: Argosy range, FL112, Centuary Class C112, C120, Columbia Class FLC112, FLD112, FLD120, M2	Front	○ ○
65103	HINO	All	300 611, 300 614, 300 711, 300 714 (MY10 & MY12), 300 811, 300 814 (MY10 & MY12), 300 815, 300 915	Front	⊕ ⊕
65103	HINO	97-on	500 (1626 series)	Front	⊕ ⊕
65103	INTERNATIONAL	All	International Trucks: F & S Series, 2000 series, 4000, series, 7100 (Check OE #'s)	Front	○ ○
65103	INTERNATIONAL	All	International Trucks: Transtar, Transtar II, Co-Transtar, Metro, MultiStop, 1000, Paystar series, 8500, 8600	Front	⊕ ⊕
65103	MACK	All	Mack Trucks: CH600, CL600, CL700, CX Vision Series	Front	○ ○
65103	MACK	All	Mack Trucks: MH, R, RW series	Front	○ ○
65103	FORD	All	F600, F700, F800, FT900 (FT series)	Rear	○ ○
65103	FORD	All	Louisville 8500, 9500, Aeromax 9500	Rear	○ ○
65107	INTERNATIONAL	All	International Trucks: 4900, 8100, 8200, 8300, 9100, 9200, 9300, 9400, 9600, 9700, 9900 (Check OE #'s)	Front	⊥ ⊕
65148	FREIGHTLINER	All	Freightliner Trucks: Argosy range, FL112, Centuary Class C112, C120, Columbia Class FLC112, FLD112, FLD120, M2	Front	⊕ ⊕
65148	FREIGHTLINER	All	Freightliner Trucks: Argosy range, FL112, Centuary Class C112, C120, Columbia Class FLC112, FLD112, FLD120, M2	Rear	⊕ ⊕
65409	INTERNATIONAL	All	International Trucks: F & S Series, 2000 series, 4000, series, 7100 (Check OE #'s)	Rear	⊕ ⊕
65409	INTERNATIONAL	All	International Trucks: 4900, 8100, 8200, 8300, 9100, 9200, 9300, 9400, 9600, 9700, 9900 (Check OE #'s)	Rear	⊕ ⊕
65420	FORD	All	Aeromax 106	Rear	⊕ ⊕
65420	FORD	All	Aeromax 8000	Rear	⊕ ⊕
65420	FORD	All	Louisville 8500, 9500, Aeromax 9500	Rear	⊕ ⊕
65420	INTERNATIONAL	All	International Trucks 9800i series	Rear	⊕ ⊕
65420	INTERNATIONAL	All	International Trucks: 5500i, 5600i, 5900i (HAS-230 susp), / 7300, 7400, 7500, 7600 (Drive axles) / 9100i, 9200i, 9400i (HAS-230/400/460 susp Drive Axles) / 9900i, 9900ix (HAS-230/400/460 susp Drive Axles) – Check OE #'s)	Rear	⊕ ⊕
65420	KENWORTH	All	Kenworth Trucks: K300, T300, T600, T800, W900	Rear	⊕ ⊕
65420	MACK	All	Mack Trucks: CH600, CL600, CL700, CX Vision Series	Rear	⊕ ⊕
65490	FREIGHTLINER	All	Freightliner Trucks: Argosy range, FL112, Centuary Class C112, C120, Columbia Class FLC112, FLD112, FLD120, M2	Front	⊕ ⊕
65490	FREIGHTLINER	All	Freightliner Trucks: MB/FL 50, 60, 70, 80, FC70, FC80, Cargo, Classic, Classic XL class, Coronada class, Lagacy class.	Rear	⊕ ⊕
65490	FREIGHTLINER	All	Freightliner Trucks: FLA, FLB COE truck & tractor, FLC112, FLD112, FLD120, Argosy range, FL112, Centuary Class C112, C120, Columbia Class FLC112, FLD112, FLD120, M2	Rear	⊕ ⊕
65492	INTERNATIONAL	All	International Trucks: Transtar, Transtar II, Co-Transtar, Metro, MultiStop, 1000, Paystar series, 8500, 8600	Rear	⊕ ⊕
65492	INTERNATIONAL	All	International Trucks: Prostar air suspension	Rear	⊕ ⊕
65492	INTERNATIONAL	All	International Trucks: 5500i, 5600i, 5900i (HAS-230 susp), / 7300, 7400, 7500, 7600 (Drive axles) / 9100i, 9200i, 9400i (HAS-230/400/460 susp Drive Axles) / 9900i, 9900ix (HAS-230/400/460 susp Drive Axles) – Check OE #'s)	Rear	⊕ ⊕
65492	PETERBILT	All	Peterbilt Trucks: 330, 357, 362 COE, 365 COE Air susp, 372 COE, 375, 376, 377, 378, 379, 385, 387	Rear	⊕ ⊕
74073	FREIGHTLINER	All	Freightliner Trucks: FLA, FLB COE truck & tractor, FLC112, FLD112, FLD120	Front	⊕ ⊕
74073	FREIGHTLINER	All	Freightliner Trucks: Argosy range, FL112, Centuary Class C112, C120, Columbia Class FLC112, FLD112, FLD120, M2	Front	⊕ ⊕
65144MM	INTERNATIONAL	All	International Trucks 4200 4300 4400 series	Front	⊕ ⊕
65144MM	INTERNATIONAL	All	International Trucks: Transtar, Transtar II, Co-Transtar, Metro, MultiStop, 1000, Paystar series, 8500, 8600	Front	⊕ ⊕
65407MM	FREIGHTLINER	All	Freightliner Trucks: FLA, FLB COE truck & tractor, FLC112, FLD112, FLD120, Argosy range, FL112, Centuary Class C112, C120, Columbia Class FLC112, FLD112, FLD120, M2	Rear	○ ○
65418 >	BENSON	All	Benson Trailer with Neway suspension	Rear	⊕ ⊕
65418 >	FORD	All	Louisville 8500, 9500, Aeromax 9500	Rear	⊕ ⊕

Key

*	See important installation information on inside front cover
!	Excluding self-levelling suspension
"..."	Special order – phone 010 900 1850, 6-12 week waiting period

~	Imported
#	Internal bump stop
⊕	Steering damper

- It is recommended that all new shock absorbers are fitted in pairs
- Do not mix gas and non-gas units on the same axle
- **Bold** part numbers indicate heavy-duty shocks
- Underlined part numbers indicate parts not immediately available
- *Italic* part numbers followed by > indicate parts to be discontinued

Truck, bus and trailer

Part number [numerical listing]

Part number	Make	Year	Application	Position	Mounting information
65418 >	HOLLAND	All	Holland truck & tractor AD246 & AD247 with air susp	Rear	⊖ ⊖
65418 >	MACK	All	Mack Trucks: CH600, CL600, CL700, CX Vision Series	Rear	⊖ ⊖
65418 >	MITSUBISHI	All	Neway truck & tractor AD123 & AD246 Drive axle	Rear	⊖ ⊖
65419MM	FORD	All	Louisville 8500, 9500, Aeromax 9500	Rear	⊖ ⊖
65419MM	MACK	All	Mack Trucks: CH600, CL600, CL700, CX Vision Series	Rear	⊖ ⊖
65488MM	INTERNATIONAL	All	International Trucks: 4900, 8100, 8200, 8300, 9100, 9200, 9300, 9400, 9600, 9700, 9900 (Check OE #s)	Rear	⊖ ⊖
65488MM	INTERNATIONAL	All	International 3200 Bus	Rear	⊖ ⊖
65488MM	INTERNATIONAL	All	International Trucks: 5500i, 5600i, 5900i (HAS-230 susp), / 7300, 7400, 7500, 7600 (Drive axles) / 9100i, 9200i, 9400i (HAS-230/400/460 susp Drive Axles) / 9900i, 9900ix (HAS-230/400/460 susp Drive Axles) – Check OE #s	Rear	⊖ ⊖
66625MM >	ISUZU	Various	EVR Series	Front	⊖ ⊖
66625MM >	ISUZU	Various	W Series	Front	⊖ ⊖
66625MM >	ISUZU	97-on	FVR 900T F-C	Front	○ ○
66625MM >	NISSAN	All	UD85, 90, 100, 2600, 2800, 3000, 3300	Front	⊖ ⊖
66639MM	ISUZU	08-on	NMR 250 5.2ton medium truck	Front	⊥ ○
66639MM	MITSUBISHI	All	FE, FK, FM Fuso Truck	Front	⊥ ○
66675MM	ISUZU	All	NPR 275 5.8ton, NPR 300 6.2ton medium truck	Front	⊥ ○
74081MM >	ISUZU	97-on	FVR 900T F-C	Front	⊥ T
AU160132	BEDFORD	65-75	J2, J3, J4, J4L, J5 & J6	Front	⊥ T
B0001 >	FIAT	00-0n	682 SWB Truck	Front	⊖ ⊖
B0001 >	FIAT	00-0n	RN130 Bus	Front	⊖ ⊖
B0001 >	OSHKOSH	00-0n	E Series	Front	⊖ ⊖
B0001 >	ISUZU	All	N3500D, N4000D	Rear	⊖ ⊖
B1279	VOLVO	All	Volvo B10, B12 Bus	Rear	⊖ ⊖
B1343	VOLVO	All	Volvo B10, B12 Bus	Front	⊖ ⊖
B5296	VOLVO	All	Volvo B10, B12 Bus	Front	⊖ ⊖
B5434	VOLVO	All	Volvo B5, B7, B8, B9, Bus	Front	○ T
B5434	VOLVO	All	Volvo B11, B13 Bus	Front	○ T
CB0106	MAN	All	F90	Front	⊖ T
CB0199	IVECO	All	ERF ECT	Front	⊖ ⊖
F1241	FRUEHAUF	All	Fruehauf SA9, SA10, SA11 Trailer	Rear	⊖ ⊖
F1241	GIGANT	All	Gigant (SMB) SA9, SA10, SA11 Trailer	Rear	⊖ ⊖
F5004	BPW / BERISCHE ACHSEN	Check OE#s	BPW / Bergische Achsen Trailers	Rear	⊖ ⊖
F5004	CARDI	Check OE#s	Cardi Trailer	Rear	⊖ ⊖
F5004	GIGANT	All	Gigant Trailer	Rear	○ ○
F5004	LECINENA	All	Lecinena Trailers	Rear	⊖ ⊖
F5004	LECITRAILER	All	Lecitrailer	Rear	⊖ ⊖
F5004	BROSHUIS	Check OE#s	Broshuis Trailers	Rear	⊖ ⊖
F5084	FRUEHAUF	All	Fruehauf SA9, SA10, SA11 Trailer	Rear	⊖ ⊖
F5084	GIGANT	All	Gigant (SMB) SA9, SA10, SA11 Trailer	Rear	⊖ ⊖
F5084	GIGANT	All	Gigant ZA9 Trailer	Rear	⊖ ⊖
F5085	FRUEHAUF	All	Fruehauf TA Trailer	Rear	○ ○
F5085	GIGANT	All	Gigant TA Trailer	Rear	⊖ ⊖

Key

*	See important installation information on inside front cover
!	Excluding self-leveling suspension
"..."	Special order – phone 010 900 1850. 6-12 week waiting period

~	Imported
#	Internal bump stop
⊖	Steering damper

- It is recommended that all new shock absorbers are fitted in pairs
- Do not mix gas and non-gas units on the same axle
- **Bold** part numbers indicate heavy-duty shocks
- Underlined part numbers indicate parts not immediately available
- *Italic* part numbers followed by > indicate parts to be discontinued

Truck, bus and trailer

Part number [numerical listing]

Part number	Make	Year	Application	Position	Mounting information
M4434	NISSAN	96-on	UD30, UD35A, UD40L	Front	⊥ ○
M4441	FORD	86-96	Triton (A.D.E. Engine)	Rear	○ ○
M4464	Dyna	78-04	Dyna Y20 / Y30 / Y40	Front	⊥ ○
M4464	FORD	86-96	Triton (A.D.E. Engine)	Front	⊥ ○
M4464	HINO	00-0n	FD Series	Front	⊥ ○
M4464	HINO	72-83	KL 340, KL360	Front	⊥ ○
M4464	JMC	10-on	Carrying MCV dropside (1.3 ton & 2.8 ton) & 2.8D 2 ton SWB & 3 ton LWB	Front	⊥ ○
M4464	JMC	10-on	Carrying MCV dropside (1.3 ton & 2.8 ton) & 2.8D 2 ton SWB & 3 ton LWB	Rear	⊥ ○
M6409	Dyna	00-on	Dyna U300 – U500 (2 – 3 ton)	Rear	○ ○
M6409	Dyna	02-on	Dyna 4-093 4x2 F-C	Rear	○ ○
M7366	Dyna	02-on	Dyna 4-093 4x2 F-C	Front	⊥ ⊕
M8038	Dyna	66-77	Dyna, Coaster U10	Rear	○ ○
M8038	Dyna	78-04	Dyna Y20 / Y30 / Y40	Rear	○ ○
M8039	Dyna	66-77	Dyna, Coaster U10	Front	○ ○
M8056	ISUZU	08-on	NQR 500 8.5ton medium truck	Rear	⊕ ⊕
T0009 >	FORD	67-81	D.1000 Trucks	Front	⊥ T
T0009 >	FORD	Mid 68-81	D.500, D.600, D.700, D.750, D.800	Front	⊥ T
T0009 >	FORD	69-81	D.550	Front	⊥ T
T0009 >	FORD	Mid 68-81	D.600, D.700, D.800 (Tractive Units)	Front	⊥ T
T0009 >	FORD	Mid 68-81	DT. 800 Rigid 6 Wheeler	Front	⊥ T
T0009 >	FORD	71-81	Single Axle : D.810 D.813 D.817 D.907 D.910 D.913, D.1010 D.1013 D.1113 D.1210 D.1211 D.1213 D.1214	Front	⊥ T
T0009 >	FORD	71-81	Single Axle : D.1311 D.1314 (Where telescopic are fitted)	Front	⊥ T
T0009 >	FORD	71-81	Single Axle Tippers : D.1311 D.1313 D.1314	Front	⊥ T
T0009 >	FORD	71-81	Single Axle Trucks & Tippers : D.1411 D.1414	Front	⊥ T
T0009 >	FORD	71-81	DA.1610 DA.1710 DA.1911 DA.2011 DA.2014	Front	⊥ T
T0009 >	FORD	71-81	Tandem Axle : DT.1711 DT.2014 (Where telescopic are fitted)	Front	⊥ T
T0009 >	LEYLAND	63-72	Clydesdale Bus	Front	⊥ T
T0009 >	LEYLAND	63-72	Retriever	Front	⊥ T
T1016	MERCEDES-BENZ	All	Actros, Atego, Axor : 2223, 2224, 2225, 2226, 2228, 2229, 2232, 2233, 2235, 2236, 2238, 2244, 2426, 2428, 2429, 2432, 2435, 2436, 2438, 2448, 2531, 2534, 2535, 2538, 2540, 2543, 2544, 2548, 2550, 2553, 2623, 2626, 2628, 2629, 2632, 2633, 2635, 2636, 2638 (M ₂ Powerliner)	Front	⊕ ⊕
T1016	MERCEDES-BENZ	All	1413, 1413K, 1414, 1417, 1417K, 1419, 1419K, 1419S, 1420, 1422, 1424, 1425, 1426, 1427, 1428, 1626, 1628, 1632, 1613, 1614, 1617, 1619, 1620, 1622, 1624, L, LK, LAK, LS, LAS, 1719, 1919, 2640, 2643, 2644, 2648, 2653, 3535	Front	⊕ ⊕
T1016	MERCEDES-BENZ	All	Atego 1926, 1928	Front	⊕ ⊕
T1016	MERCEDES-BENZ	All	1838	Front	⊕ ⊕
T1016	POWERSTAR	All	26.28 10 ton tipper	Front	⊕ ⊕
T1016	MERCEDES-BENZ	All	Atego 1929, 1932, 1933, 1935, 1936, 1938, 1948	Front	⊕ ⊕
T1029	MAN	96-99	Man 14, 16, 19, 22, 26, 30, 32, 33, 38, 40, 41, 48 (Check OE #'s)	Front	⊥ ⊕
T1039 >	MAN	96-99	Man 14, 16, 19, 22, 26, 30, 32, 33, 38, 40, 41, 48 (Check OE #'s)	Rear	⊕ ⊕
T1069	MERCEDES-BENZ	All	1114, 1117, 1120, 1124	Front	⊕ ⊕
T1093	MAN	All	M90	Front	⊥ T
T1093	SAMAG / SAMIL	All	SAMIL 20	Rear	⊥ T
T1093	MAN	All	F90	Front	⊥ T

Key

*	See important installation information on inside front cover
!	Excluding self-leveling suspension
...	Special order – phone 010 900 1850. 6-12 week waiting period

~	Imported
#	Internal bump stop
⊕	Steering damper

- It is recommended that all new shock absorbers are fitted in pairs
- Do not mix gas and non-gas units on the same axle
- **Bold** part numbers indicate heavy-duty shocks
- Underlined part numbers indicate parts not immediately available
- *Italic* part numbers followed by > indicate parts to be discontinued

Truck, bus and trailer

Part number [numerical listing]

Part number	Make	Year	Application	Position	Mounting information
T1100 >	SCANIA	All	Scania 112	Front	⊥ ⊖
T1101 > <u>T1331</u>	SCANIA	All	Scania 112, 82, 92, 93, 113, 142, 143	Front	⊥ ○
T1142	MAN	All	Man 6.90, 6.100, 8.90, 8.100, 8.136, 8.150, 9.100, 9.135, 9.136, 9.150	Front	⊥ T
T1145	SCANIA	All	Scania 94, 113, 143	Front	⊥ ⊖
T1149	VOLVO	All	FL7 & FL10 & FL12	Front	⊖ ⊖
T1177	VOLVO	All	FH12	Front	⊖ ⊖
T1177	VOLVO	All	F12 & F16	Front	⊖ ⊖
T1189	MAN	All	Man 18, 19, 21	Front	⊥ ⊖
T1190	MAN	96-99	Man 14, 16, 19, 22, 26, 30, 32, 33, 38, 40, 41, 48 (Check OE #'s)	Front	⊥ ⊖
T1190	MAN	All	Man 18, 19, 21	Front	⊥ ⊖
T1201	MERCEDES-BENZ	All	Atego, Actros & Axor 1823 -> 1857 Actros 1858, 1860	Rear	⊖ ⊖
T1201	MERCEDES-BENZ	All	Actros, Axor: 3331, 3340, 3343, 3348, 3353	Rear	⊖ ⊖
T1204	MERCEDES-BENZ	All	Atego, Actros & Axor 1823 -> 1857 Actros 1858, 1860	Front	⊖ ⊖
T1204	POWERSTAR	All	26.28 10 ton tipper	Front	⊖ ⊖
T1204	MERCEDES-BENZ	All	Atego, 1013, 1017, 1019, 1213, 1214, 1215, 1216, 1217, 2018, 1219, 1222, 1223, 1224, 1225, 1226, 1228, 1229, 1420, 1422, 1424	Front	⊖ ⊖
T1207	MERCEDES-BENZ	All	Atego, Actros & Axor 1823 -> 1857 Actros 1858, 1860	Front	⊖ ⊖
T1207	MERCEDES-BENZ	All	Actros, Axor: 3331, 3340, 3343, 3348, 3353	Front	⊖ ⊖
T1207	MERCEDES-BENZ	All	Actros 2031, 2040, 2053, 2531, 2535, 2540, 2543, 2548, 2631, 2635, 2640, 2643, 2648, 2653, 2657	Front	⊖ ⊖
T1210	MERCEDES-BENZ	All	2031, 2035, 2038, 2044, 2055	Rear	⊖ ⊖
T1210	MERCEDES-BENZ	All	Atego, Actros & Axor 1823 -> 1857 Actros 1858, 1860	Rear	⊖ ⊖
T1210	MERCEDES-BENZ	All	Actros, Axor: 3331, 3340, 3343, 3348, 3353	Rear	⊖ ⊖
T1215	SCANIA	All	Scania 94, 114, 124, 144	Front	⊥ ⊖
T1216	SCANIA	All	Scania 94, 114, 124, 144	Rear	⊥ ⊖
T1220	MERCEDES-BENZ	All	3028, 3033, 3035, 3036, 3228, Axor 3228C, 3235, 3238, 3244, 3335, 3534, 3535	Front	⊖ ⊖
T1220	MERCEDES-BENZ	All	Actros, Atego, Axor : 2223, 2224, 2225, 2226, 2228, 2229, 2232, 2233, 2235, 2236, 2238, 2244, 2426, 2428, 2429, 2432, 2435, 2436, 2438, 2448, 2531, 2534, 2535, 2538, 2540, 2543, 2544, 2548, 2550, 2553, 2623, 2626, 2628, 2629, 2632, 2633, 2635, 2636, 2638 (INCL Powerliner)	Front	⊖ ⊖
T1220	MERCEDES-BENZ	All	Atego, Actros & Axor 1823 -> 1857 Actros 1858, 1860	Front	⊖ ⊖
T1220	MERCEDES-BENZ	All	Actros, Axor: 3331, 3340, 3343, 3348, 3353	Front	⊖ ⊖
T1220	MERCEDES-BENZ	All	Actros 2031, 2040, 2053, 2531, 2535, 2540, 2543, 2548, 2631, 2635, 2640, 2643, 2648, 2653, 2657	Front	⊖ ⊖
T1220	MERCEDES-BENZ	All	Atego 1923, 1924, Axor 1820, 1824, Actros 3231, 3232, 3241, 3246, 3248, 3332, 3336, 3341, 3344, 3346, 3350, 3351, 3354, 3355, 3357, 3360, Axor, Atego : 2523, 2528, 2529, 2533, Actros 4140, 4144, 4148, Actros, Atego, Axor 2628, 2629, 2632, 2633, 2636, 2641, 2644, 2646, 2650, 2651, 2654, 2655, 2658, 2932, Actros 2032, 2036, 2041, 2044, 2046, 2050, 2051, 2223, 2226, 2228, 2232, 2233, 2235, 2236, 2238 (INCL Atego), Actros, Atego, Axor : 2523, 2528, 2532, 2536, 2541, 2544, 2546, 2548, 2551, 2555, 2560	Front	⊖ ⊖
T1220	MERCEDES-BENZ	All	Atego 1513, 1517, 1518, 1519, 1522, 1523, 1524, 1526, 1528, 1529, 1621, Atego 1317, 1318, 1322, 1323, 1324, 1326, 1328, 1329	Front	⊖ ⊖
T1220	MERCEDES-BENZ	All	Atego 1: 712, 714, 715, 717, 812, 814, 815, 817, 823, Atego 914, 917, 923, 1017, 1023	Front	⊖ ⊖
T1220	MERCEDES-BENZ	All	MK, NG	Front	⊖ ⊖
T1223	RENAULT	94-on	Renault AE385Ti & AE420Ti	Front	⊥ T
T1246	MERCEDES-BENZ	All	Atego, Actros & Axor 1823 -> 1857 Actros 1858, 1860	Front	⊖ ⊖
T1246	MERCEDES-BENZ	All	Atego 1513, 1517, 1518, 1519, 1522, 1523, 1524, 1526, 1528, 1529, 1621, Atego 1317, 1318, 1322, 1323, 1324, 1326, 1328, 1329	Front	⊖ ⊖
T1250 >	HINO	00-On	FE Series	Front	⊥ ○
T1254	VOLVO	All	FL180, FL220, FL250	Front	⊖ ⊖
T1255	MERCEDES-BENZ	All	Atego 1: 712, 714, 715, 717, 812, 814, 815, 817, 823, Atego 914, 917, 923, 1017, 1023	Front	⊖ ⊖

Key

*	See important installation information on inside front cover
!	Excluding self-levelling suspension
"..."	Special order - phone 010 900 1850. 6-12 week waiting period

~	Imported
#	Internal bump stop
⊖	Steering damper

- It is recommended that all new shock absorbers are fitted in pairs
- Do not mix gas and non-gas units on the same axle
- **Bold** part numbers indicate heavy-duty shocks
- Underlined part numbers indicate parts not immediately available
- *Italic* part numbers followed by > indicate parts to be discontinued

Truck, bus and trailer

Part number [numerical listing]

Part number	Make	Year	Application	Position	Mounting information
T1256	MERCEDES-BENZ	All	Atego 914, 917, 923, 1017, 1023, Atego 1: 712, 714, 715, 717, 812, 814, 815, 817, 823	Rear	⊖ ⊖
T1256	MERCEDES-BENZ	All	Atego 1317, 1318, 1322, 1323, 1324, 1326, 1328, 1329	Rear	⊖ ⊖
T1256	MERCEDES-BENZ	All	Atego, 1013, 1017, 1019, 1213, 1214, 1215, 1216, 1217, 2018, 1219, 1222, 1223, 1224, 1225, 1226, 1228, 1229, 1420, 1422, 1424	Rear	⊖ ⊖
T1261	IVECO	All	Eurostar / Eurotech	Front	⊥ ⊖
T1261	IVECO	All	Stralis	Front	⊥ ⊖
T1273	MERCEDES-BENZ	All	Atego, Actros & Axor 1823 -> 1857 Actros 1858, 1860	Rear	⊖ ⊖
T1273	MERCEDES-BENZ	All	Atego 1317, 1318, 1322, 1323, 1324, 1326, 1328, 1329	Rear	⊖ ⊖
T1273	MERCEDES-BENZ	All	Atego 1923,1924	Rear	⊖ ⊖
T1273	MERCEDES-BENZ	All	2223, 2226, 2228, 2232, 2233, 2235, 2236, 2238 (MC Atego)	Rear	⊖ ⊖
T1273	MERCEDES-BENZ	All	Actros, Atego, Axor : 2223, 2224, 2225, 2226, 2228, 2229, 2232, 2233, 2235, 2236, 2238, 2244, 2426, 2428, 2429, 2432, 2435, 2436, 2438, 2448, 2531, 2534, 2535, 2538, 2540, 2543, 2544, 2548, 2550, 2553, 2623, 2626, 2628, 2629, 2632, 2633, 2635, 2636, 2638 (MC Powerliner)	Rear	⊖ ⊖
T1273	MERCEDES-BENZ	All	Actros, Atego, Axor : 2523, 2528, 2532, 2536, 2541, 2544, 2546, 2548, 2551, 2555, 2560	Rear	⊖ ⊖
T1273	MERCEDES-BENZ	All	Atego 1513, 1517, 1518, 1519, 1522, 1523, 1524, 1526, 1528, 1529, 1621,	Rear	⊖ ⊖
T1273	MERCEDES-BENZ	All	Atego 914, 917, 923, 1017, 1023, Atego 1: 712, 714, 715, 717, 812, 814, 815, 817, 823	Rear	⊖ ⊖
T1273	MERCEDES-BENZ	All	Axor, Atego : 2523, 2528, 2529, 2533	Rear	⊖ ⊖
T1273	MERCEDES-BENZ	All	Actros, Atego, Axor 2628, 2629, 2632, 2633, 2636, 2641, 2644, 2646, 2650, 2651, 2654, 2655, 2658, 2932	Rear	⊖ ⊖
T1296	SCANIA		Scania P, G, R, T - series	Rear	⊖ ⊖
T1296	SCANIA	All	Scania 94, 114, 124, 144	Rear	⊖ ⊖
T1308	MAN	All	TGA: 18., 19., 24., 26., 28., 32., 33., 35., 40., 41.	Front	⊖ ⊖
T1308	MAN	All	TGS: 18., 19., 24., 26., 28., 32., 33., 35., 40., 41.	Front	⊖ ⊖
T1308	MAN	All	TGX	Front	⊖ ⊖
T1313	MAN	All	TGL	Rear	⊖ ⊖
T1318	ERF	All	ERF ECT 18..., 26...	Front	⊥ ⊖
T1318	IVECO	All	ERF ECT	Front	⊥ ⊖
T1318	MAN	All	TGA: 18., 19., 24., 26., 28., 32., 33., 35., 40., 41.	Front	⊥ ⊖
T1320	MAN	All	TGA: 18., 19., 24., 26., 28., 32., 33., 35., 40., 41.	Front	⊖ ⊖
T1320	MAN	All	TGS: 18., 19., 24., 26., 28., 32., 33., 35., 40., 41.	Front	⊖ ⊖
T1320	MAN	All	TGX	Front	⊖ ⊖
T1320	ERF	All	ERF ECT 18..., 26...	Front	⊖ ⊖
T1321	MAN	All	TGA: 18., 19., 24., 26., 28., 32., 33., 35., 40., 41.	Front	⊖ ⊖
T1321	MAN	All	TGS: 18., 19., 24., 26., 28., 32., 33., 35., 40., 41.	Front	⊖ ⊖
T1321	MAN	All	TGX	Front	⊖ ⊖
T1322	MAN	All	TGL	Front	⊥ ⊖
T1330	SCANIA	All	Scania 92, 93, 94, 112, 114, 123, 124, 142, 143, 144, P, G, R, T - series	Front	⊥ ○
T1333	MAN	All	TGA: 18., 19., 24., 26., 28., 32., 33., 35., 40., 41.	Front	⊖ ⊖
T1333	MAN	All	TGS: 18., 19., 24., 26., 28., 32., 33., 35., 40., 41.	Front	⊖ ⊖
T1333	MAN	All	TGX	Front	⊖ ⊖
T1344	MAN	All	TGL	Rear	⊖ ⊖
T1346	MAN	All	TGM	Front	⊖ ⊖
T1346	SAMAG / SAMIL	All	SAMIL 20	Front	⊖ ⊖
T1353	MAN	All	TGA: 18., 19., 24., 26., 28., 32., 33., 35., 40., 41.	Front	⊖ ⊖
T1359	MAN	All	TGM	Front	⊥ ⊖

Key

*	See important installation information on inside front cover
!	Excluding self-levelling suspension
"..."	Special order - phone 010 900 1850. 6-12 week waiting period

~	Imported
#	Internal bump stop
⊖	Steering damper

- It is recommended that all new shock absorbers are fitted in pairs
- Do not mix gas and non-gas units on the same axle
- **Bold** part numbers indicate heavy-duty shocks
- Underlined part numbers indicate parts not immediately available
- *Italic* part numbers followed by > indicate parts to be discontinued

Truck, bus and trailer

Part number [numerical listing]

Part number	Make	Year	Application	Position	Mounting information
T1360	VOLVO	All	FH16, FM9, FM12, FH12	Rear	⊖ ⊖
T1360	VOLVO	All	FM7, FM10	Rear	⊖ ⊖
T5047	MAN	96-99	Man 14, 16, 19, 22, 26, 30, 32, 33, 38, 40, 41, 48 (Check OE #'s)	Rear	⊖ ⊖
T5047	MAN	All	Man 17, 22, 23, 26	Rear	⊖ ⊖
T5052	DAF	All	DAF 95	Front	⊥ ⊖
T5052	DAF		DAF CF85	Front	⊥ ⊖
T5052	DAF	All	DAF FA & FT 95	Front	⊥ ⊖
T5052	DAF	All	DAF XF95, XF105	Front	⊥ ⊖
T5052	DAF		DAF CF75	Front	⊥ ⊖
T5052	NISSAN	97-on	UD80	Front	⊥ ⊖
T5053	DAF	All	DAF XF95, XF105	Front	⊥ ⊖
T5053	DAF	Various	DAF 65 CF (front leaf, rear air susp)	Front	⊥ ⊖
T5053	DAF	Various	DAF 65 (front leaf, rear air susp)	Front	⊥ ⊖
T5053	DAF	Various	DAF 75	Front	⊥ ⊖
T5053	NISSAN	97-on	UD80	Front	⊥ ⊖
T5053	DAF		DAF CF75	Front	⊥ ⊖
T5053	DAF	All	DAF FTS85 (CF85 series), DAF 85.340, 85.330, 85.430, DAF FA & FT 95	Front	⊥ ⊖
<i>T5054</i> >	MERCEDES-BENZ	All	1722, 1724, 1726,	Rear	⊥ ⊖
<i>T5054</i> >	MERCEDES-BENZ	All	1624, L, LK, LAK, LS, LAS, Axor 1820, 1824, 1413, 1413K, 1414, 1417, 1417K, 1419, 1419K, 1419S, 1420, 1422, 1424, 1425, 1426, 1427, 1428, 1613, 1614, 1617, 1619, 1620, 1622	Rear	⊥ ⊖
<i>T5054</i> >	MERCEDES-BENZ	All	Atego, 1013, 1017, 1019, 1213, 1214, 1215, 1216, 1217, 2018, 1219, 1222, 1223, 1224, 1225, 1226, 1228, 1229, 1420, 1422, 1424, 2219, 2222	Rear	⊥ ⊖
<i>T5054</i> >	MERCEDES-BENZ	All	Actros, Atego, Axor : 2223, 2224, 2225, 2226, 2228, 2229, 2232, 2233, 2235, 2236, 2238, 2244, 2426, 2428, 2429, 2432, 2435, 2436, 2438, 2448, 2531, 2534, 2535, 2538, 2540, 2543, 2544, 2548, 2550, 2553, 2623, 2626, 2628, 2629, 2632, 2633, 2635, 2636, 2638 (incl Powerliner)	Rear	⊥ ⊖
T5059	SCANIA	All	Scania 93	Rear	⊥ ⊖
T5059	SCANIA	All	Scania 82, 62, 112, 113, 142, 143,	Rear	⊥ ⊖
T5063	SCANIA	All	Scania 123, 3 Series	Front	⊥ ⊖
<i>T5121</i> >	MAN	96-99	Man 14, 16, 19, 22, 26, 30, 32, 33, 38, 40, 41, 48 (Check OE #'s)	Rear	⊖ ⊖
<i>T5121</i> >	MAN	All	Man 17, 22, 23, 26	Rear	⊖ ⊖
T5137	MERCEDES-BENZ	All	Actros 2032, 2036, 2041, 2044, 2046, 2050, 2051	Rear	⊖ ⊖
T5137	MERCEDES-BENZ	All	Atego, Actros & Axor 1823 -> 1857 Actros 1858, 1860	Rear	⊖ ⊖
T5137	MERCEDES-BENZ	All	Actros, Axor: 3331, 3340, 3343, 3348, 3353	Rear	⊖ ⊖
T5137	MERCEDES-BENZ	All	Actros, Atego, Axor : 2223, 2224, 2225, 2226, 2228, 2229, 2232, 2233, 2235, 2236, 2238, 2244, 2426, 2428, 2429, 2432, 2435, 2436, 2438, 2448, 2531, 2534, 2535, 2538, 2540, 2543, 2544, 2548, 2550, 2553, 2623, 2626, 2628, 2629, 2632, 2633, 2635, 2636, 2638 (incl Powerliner)	Rear	⊖ ⊖
T5137	MERCEDES-BENZ	All	Actros 3231, 3232, 3241, 3246, 3248, 3332, 3336, 3341, 3344, 3346, 3350, 3351, 3354, 3355, 3357, 3360	Rear	⊖ ⊖
T5137	MERCEDES-BENZ	All	Actros, Atego, Axor : 2523, 2528, 2532, 2536, 2541, 2544, 2546, 2548, 2551, 2555, 2560	Rear	⊖ ⊖
T5137	MERCEDES-BENZ	All	Actros, Atego, Axor 2628, 2629, 2632, 2633, 2636, 2641, 2644, 2646, 2650, 2651, 2654, 2655, 2658, 2932	Rear	⊖ ⊖
T5137	MERCEDES-BENZ	All	Actros 4140, 4144, 4148	Rear	⊖ ⊖
T5144	SCANIA	All	Scania 94, 124, 114, 144	Rear	⊖ ⊖
T5155	VOLVO	All	F10, F12 & F16, FL7 & FL10 & FL12	Rear	⊖ ⊖
T5171	TATA	All	Tata 1518C	Front	⊖ ⊖
T5171	MERCEDES-BENZ	All	Atego, Actros & Axor 1823 -> 1857 Actros 1858, 1860	Rear	⊖ ⊖
T5171	MERCEDES-BENZ	All	1853, 1857	Rear	⊖ ⊖

Key

*	See important installation information on inside front cover
!	Excluding self-levelling suspension
"..."	Special order - phone 010 900 1850. 6-12 week waiting period

~	Imported
#	Internal bump stop
⊖	Steering damper

- It is recommended that all new shock absorbers are fitted in pairs
- Do not mix gas and non-gas units on the same axle
- **Bold** part numbers indicate heavy-duty shocks
- Underlined part numbers indicate parts not immediately available
- *Italic* part numbers followed by > indicate parts to be discontinued

Truck, bus and trailer

Part number [numerical listing]

Part number	Make	Year	Application	Position	Mounting information
T5177	VOLVO	All	FL6, FL7 & FL10 & FL12, FL180, FL220, FL250	Rear	⊖ ⊖
T5177	VOLVO	All	FH16, FM9, FM12, FH12	Rear	⊖ ⊖
T5178	MERCEDES-BENZ	All	Atego 1513, 1517, 1518, 1519, 1522, 1523, 1524, 1526, 1528, 1529, 1621.	Rear	⊖ ⊖
T5183	DAF		DAF FA & FT 95 (7.5 ton)	Front	⊥ T
T5183	DAF	All	DAF XF95, XF105	Front	⊥ T
T5227	DAF		DAF 65 CF (front leaf, rear air susp)	Front	⊥ T
T5227	DAF		DAF 65 (front leaf, rear air susp)	Front	⊥ T
T5227	DAF		DAF 75	Front	⊥ T
T5227	DAF	All	DAF FTS85 (CF85 series), DAF 85.340, 85.330, 85.430, DAF FA & FT 95	Front	⊥ T
T5227	RENAULT	94-on	Renault AE385Ti & AE420Ti	Rear	⊥ T
T5243	SCANIA	All	Scania 93	Rear	⊥ ⊖
T5256	MERCEDES-BENZ	All	Atego, Actros & Axor 1823 -> 1857 Actros 1858, 1860	Rear	⊖ ⊖
T5256	MERCEDES-BENZ	All	Actros, Axor: 3331, 3340, 3343, 3348, 3353	Rear	⊖ ⊖
T5256	MERCEDES-BENZ	All	Actros, Atego, Axor : 2223, 2224, 2225, 2226, 2228, 2229, 2232, 2233, 2235, 2236, 2238, 2244, 2426, 2428, 2429, 2432, 2435, 2436, 2438, 2448, 2531, 2534, 2535, 2538, 2540, 2543, 2544, 2548, 2550, 2553, 2623, 2626, 2628, 2629, 2632, 2633, 2635, 2636, 2638 (Powerliner)	Rear	⊖ ⊖
T5256	MERCEDES-BENZ	All	Actros, Atego, Axor : 2523, 2528, 2532, 2536, 2541, 2544, 2546, 2548, 2551, 2555, 2560	Rear	⊖ ⊖
T5256	MERCEDES-BENZ	All	Axor, Atego : 2523, 2528, 2529, 2533	Rear	⊖ ⊖
T5256	MERCEDES-BENZ	All	Actros, Atego, Axor 2628, 2629, 2632, 2633, 2636, 2641, 2644, 2646, 2650, 2651, 2654, 2655, 2658, 2932	Rear	⊖ ⊖
T5256	MERCEDES-BENZ	All	Actros 2032, 2036, 2041, 2044, 2046, 2050, 2051	Rear	⊖ ⊖
T5256	MERCEDES-BENZ	All	Actros 3231, 3232, 3241, 3246, 3248, 3332, 3336, 3341, 3344, 3346, 3350, 3351, 3354, 3355, 3357, 3360	Rear	⊖ ⊖
T5256	MERCEDES-BENZ	All	3028, 3033, 3035, 3036, 3228, Axor 3228C, 3235, 3238, 3244, 3335, 3534, 3535	Rear	⊖ ⊖
T5261	ERF	All	ERF ECT 18...., 26...	Rear	⊖ ⊖
T5261	MAN	All	TGA: 18., 19., 24., 26., 28., 32., 33., 35., 40., 41.	Rear	⊖ ⊖
T5261	MAN	All	TGX	Rear	⊖ ⊖
T5261	MAN	All	TGS: 18., 19., 24., 26., 28., 32., 33., 35., 40., 41.	Rear	⊖ ⊖
T5266	ERF	All	ERF ECT 18...., 26...	Rear	⊖ ⊖
T5266	MAN	All	TGA: 18., 19., 24., 26., 28., 32., 33., 35., 40., 41.	Rear	⊖ ⊖
T5266	MAN	All	TGX	Rear	⊖ ⊖
T5266	MAN	All	TGS: 18., 19., 24., 26., 28., 32., 33., 35., 40., 41.	Rear	⊖ ⊖
T5269	IVECO	All	Eurostar / Eurotech	Rear	⊖ ⊖
T5269	IVECO	All	Eurotrakker	Rear	⊖ ⊖
T5269	IVECO	All	Stralis	Rear	⊖ ⊖
T5275	ERF	All	ERF ECT 18...., 26...	Rear	⊖ ⊖
T5275	MAN	All	TGX	Rear	⊖ ⊖
T5275	MAN	All	TGS: 18., 19., 24., 26., 28., 32., 33., 35., 40., 41.	Rear	⊖ ⊖
T5275	MAN	All	TGA: 18., 19., 24., 26., 28., 32., 33., 35., 40., 41.	Rear	⊖ ⊖
T5276	ERF	All	ERF ECT 18...., 26...	Rear	⊖ ⊖
T5276	MAN	All	TGA: 18., 19., 24., 26., 28., 32., 33., 35., 40., 41.	Rear	⊖ ⊖
T5277	MAN	All	TGA: 18., 19., 24., 26., 28., 32., 33., 35., 40., 41.	Rear	⊖ ⊖
T5277	MAN	All	TGS: 18., 19., 24., 26., 28., 32., 33., 35., 40., 41.	Rear	⊖ ⊖
T5277	MAN	All	E2000	Rear	⊖ ⊖
T5277	MAN	All	F2000	Rear	⊖ ⊖

Key

*	See important installation information on inside front cover
!	Excluding self-levelling suspension
...	Special order - phone 010 900 1850. 6-12 week waiting period

~	Imported
#	Internal bump stop
⊖	Steering damper

- It is recommended that all new shock absorbers are fitted in pairs
- Do not mix gas and non-gas units on the same axle
- **Bold** part numbers indicate heavy-duty shocks
- Underlined part numbers indicate parts not immediately available
- *Italic* part numbers followed by > indicate parts to be discontinued

Truck, bus and trailer

Part number [numerical listing]

Part number	Make	Year	Application	Position	Mounting information
T5349	MAN	All	TGA: 18., 19., 24., 26., 28., 32., 33., 35., 40., 41.	Rear	⊖ ⊖
T5349	MAN	All	TGS: 18., 19., 24., 26., 28., 32., 33., 35., 40., 41.	Rear	⊖ ⊖
T5349	MAN	All	F2000	Rear	⊖ ⊖
T5349	MAN	All	TGM	Rear	⊖ ⊖
T5349	MAN	All	E2000	Rear	⊖ ⊖
T5350	MAN	All	TGA: 18., 19., 24., 26., 28., 32., 33., 35., 40., 41.	Rear	⊖ ⊖
T5350	MAN	All	TGS: 18., 19., 24., 26., 28., 32., 33., 35., 40., 41.	Rear	⊖ ⊖
T5350	MAN	All	F2000	Rear	⊖ ⊖
<u>T5358</u>	MERCEDES-BENZ	All	2640, 2643, 2644, 2648, 2653	Rear	⊖ ⊖
<u>T5358</u>	MERCEDES-BENZ	All	1844, 1850	Rear	⊖ ⊖
T5358	MERCEDES-BENZ	All	Actros, Atego, Axor : 2523, 2528, 2532, 2536, 2541, 2544, 2546, 2548, 2551, 2555, 2560	Rear	⊖ ⊖
T5358	MERCEDES-BENZ	All	Actros, Atego, Axor : 2223, 2224, 2225, 2226, 2228, 2229, 2232, 2233, 2235, 2236, 2238, 2244, 2426, 2428, 2429, 2432, 2435, 2436, 2438, 2448, 2531, 2534, 2535, 2538, 2540, 2543, 2544, 2548, 2550, 2553, 2623, 2626, 2628, 2629, 2632, 2633, 2635, 2636, 2638 (incl) Powerliner)	Rear	⊖ ⊖
<u>T5358</u>	MERCEDES-BENZ	All	Atego, Actros & Axor 1823 -> 1857 Actros 1858, 1860	Rear	⊖ ⊖
T5360	MERCEDES-BENZ	All	Actros, Atego, Axor : 2223, 2224, 2225, 2226, 2228, 2229, 2232, 2233, 2235, 2236, 2238, 2244, 2426, 2428, 2429, 2432, 2435, 2436, 2438, 2448, 2531, 2534, 2535, 2538, 2540, 2543, 2544, 2548, 2550, 2553, 2623, 2626, 2628, 2629, 2632, 2633, 2635, 2636, 2638 (incl) Powerliner)	Front	⊖ ⊖
T5360	MERCEDES-BENZ	All	Actros 2031, 2040, 2053, 2531, 2535, 2540, 2543, 2548, 2631, 2635, 2640, 2643, 2648, 2653, 2657	Front	⊖ ⊖
T5360	MERCEDES-BENZ	All	Atego 1513, 1517, 1518, 1519, 1522, 1523, 1524, 1526, 1528, 1529, 1621, Atego 1317, 1318, 1322, 1323, 1324, 1326, 1328, 1329	Front	⊖ ⊖
T5360	SAMAG / SAMIL	All	SAMIL 50 & 100	Front	⊖ ⊖
T5360	MERCEDES-BENZ	All	Atego 1923, 1924., Axor 1820, 1824, Actros 3231, 3232, 3241, 3246, 3248, 3332, 3336, 3341, 3344, 3346, 3350, 3351, 3354, 3355, 3357, 3360, Axor, Atego : 2523, 2528, 2529, 2533, Actros 4140, 4144, 4148, Actros, Atego, Axor 2628, 2629, 2632, 2633, 2636, 2641, 2644, 2646, 2650, 2651, 2654, 2655, 2658, 2932, Actros 2032, 2036, 2041, 2044, 2046, 2050, 2051, 2223, 2226, 2228, 2232, 2233, 2235, 2236, 2238 (incl) Atego), Actros, Atego, Axor : 2523, 2528, 2532, 2536, 2541, 2544, 2546, 2548, 2551, 2555, 2560	Front	⊖ ⊖
T5360	MERCEDES-BENZ	All	Atego 1: 712, 714, 715, 717, 812, 814, 815, 817, 823, Atego 914, 917, 923, 1017, 1023	Front	⊖ ⊖
T5360	MERCEDES-BENZ	All	3028, 3033, 3035, 3036, 3228, Axor 3228C, 3235, 3238, 3244, 3335, 3534, 3535	Front	⊖ ⊖
T5360	MERCEDES-BENZ	All	Actros, Axor: 3331, 3340, 3343, 3348, 3353	Front	⊖ ⊖
T5360	MERCEDES-BENZ	All	Atego, Actros & Axor 1823 -> 1857 Actros 1858, 1860	Front	⊖ ⊖
T5363	MERCEDES-BENZ	All	Actros, Atego, Axor 2628, 2629, 2632, 2633, 2636, 2641, 2644, 2646, 2650, 2651, 2654, 2655, 2658, 2932	Rear	⊖ ⊖
T5372	MERCEDES-BENZ	All	Atego, Actros & Axor 1823 -> 1857 Actros 1858, 1860	Rear	⊖ ⊖
T5372	MERCEDES-BENZ	All	2031, 2035, 2038, 2044, 2055	Rear	⊖ ⊖
T5372	MERCEDES-BENZ	All	Actros, Axor: 3331, 3340, 3343, 3348, 3353	Rear	⊖ ⊖
T5386	MAN	All	F2000	Rear	⊥ ⊖
T5386	MAN	All	F90	Rear	⊥ ⊖
T5387	SCANIA		Scania P, G, R, T - series	Rear	⊖ ⊖
T5387	SCANIA	All	Scania 94, 114, 124, 144	Rear	⊖ ⊖
T5391	SCANIA	98-'04	Scania 4 Series	Rear	⊖ ⊖
T5400	ERF	All	ERF ECT 18..., 26...	Rear	⊖ ⊖
T5400	MAN	All	TGA: 18., 19., 24., 26., 28., 32., 33., 35., 40., 41.	Rear	⊖ ⊖
T5400	MAN	All	TGX	Rear	⊖ ⊖
T5400	MAN	All	TGS: 18., 19., 24., 26., 28., 32., 33., 35., 40., 41.	Rear	⊖ ⊖
T5400	MAN	All	TGM	Rear	⊖ ⊖
T5403	MERCEDES-BENZ	All	Actros, Atego, Axor : 2223, 2224, 2225, 2226, 2228, 2229, 2232, 2233, 2235, 2236, 2238, 2244, 2426, 2428, 2429, 2432, 2435, 2436, 2438, 2448, 2531, 2534, 2535, 2538, 2540, 2543, 2544, 2548, 2550, 2553, 2623, 2626, 2628, 2629, 2632, 2633, 2635, 2636, 2638 (incl) Powerliner)	Rear	⊖ ⊖

Key

★	See important installation information on inside front cover
!	Excluding self-levelling suspension
"..."	Special order - phone 010 900 1850. 6-12 week waiting period

~	Imported
#	Internal bump stop
⊖	Steering damper

- It is recommended that all new shock absorbers are fitted in pairs
- Do not mix gas and non-gas units on the same axle
- **Bold** part numbers indicate heavy-duty shocks
- Underlined part numbers indicate parts not immediately available
- *Italic* part numbers followed by > indicate parts to be discontinued

Truck, bus and trailer

Part number [numerical listing]

Part number	Make	Year	Application	Position	Mounting information
T5403	MERCEDES-BENZ	All	Atego 1317, 1318, 1322, 1323, 1324, 1326, 1328, 1329	Rear	⊖ ⊖
T5403	MERCEDES-BENZ	All	Atego. 1013, 1017, 1019, 1213, 1214, 1215, 1216, 1217, 2018, 1219, 1222, 1223, 1224, 1225, 1226, 1228, 1229, 1420, 1422, 1424	Rear	⊖ ⊖
T5403	MERCEDES-BENZ	All	Atego 1513, 1517, 1518, 1519, 1522, 1523, 1524, 1526, 1528, 1529, 1621,	Rear	⊖ ⊖
T5403	MERCEDES-BENZ	All	Atego 1929, 1932, 1933, 1935, 1936, 1938, 1948	Rear	⊖ ⊖
T5403	MERCEDES-BENZ	All	Atego 1923,1924	Rear	⊖ ⊖
T5403	MERCEDES-BENZ	All	Atego 1926, 1928	Rear	⊖ ⊖
T5406	MAN	All	TGM	Rear	⊖ ⊖
T5429	MAN	96-99	Man 14, 16, 19, 22, 26, 30, 32, 33, 38, 40, 41, 48 (Check OE #'s)	Rear	⊖ ⊖
T5429	MAN	All	Man 17, 22, 23, 26	Rear	⊖ ⊖
T5429	MAN	All	M2000	Rear	⊖ ⊖
T5429	MAN	All	Man 18, 19, 21	Rear	⊖ ⊖
T5429	MAN	All	F2000	Rear	⊖ ⊖
T5429	MAN	All	F90	Rear	⊥ ⊖
T5444	RENAULT	All	Renault PREMIUM trucks	Rear	⊥ ⊖
T5444	VOLVO	All	FH (380, 400, 420, 440, 460, 480, 500, 520, 540)	Rear	⊥ ⊖
V1095	MERCEDES-BENZ	All	408, 409, 410, 508, 608, 613	Front	⊖ ⊖
V1132	NISSAN	98-06	TL75.28, TL90.32	Front	⊥ ○
V1133	NISSAN	98-06	TL75.28, TL90.32	Rear	○ ○

Key

*	See important installation information on inside front cover
!	Excluding self-levelling suspension
"..."	Special order – phone 010 900 1850. 6-12 week waiting period

~	Imported
#	Internal bump stop
⊖	Steering damper

- It is recommended that all new shock absorbers are fitted in pairs
- Do not mix gas and non-gas units on the same axle
- **Bold** part numbers indicate heavy-duty shocks
- Underlined part numbers indicate parts not immediately available
- *Italic* part numbers followed by > indicate parts to be discontinued

Truck, bus and trailer

Part number [numerical listing]

Part number	Make	Year	Application	Position	Mounting information
SPECIAL ORDER					
"65407MM" >	HINO	97-on	500 (1626 series)	Front	⊖ ⊖
"65482"	FORD	All	F600, F700, F800, FT900 (FT series)	Front	⊖ ⊖
"65482"	FREIGHTLINER	All	Freightliner Trucks: MB/FL 50, 60, 70, 80, FC70, FC80, Cargo, Classic, Classic XL class, Coronada class, Lagacy class.	Front	⊖ ⊖
"65484MM"	HINO	97-on	500 (1626 series)	Rear	⊖ ⊖
"65485MM"	HENDRICKSON	All	Hendrickson trailer (various)	Rear	⊖ ⊖
"66601MM"	ISUZU	97-on	FRR 500 F-C	Front	⊥ ⊖
"66601MM"	ISUZU	All	NRR series	Front	⊥ ⊖
"66601MM"	ISUZU	All	NPR 275 5.8ton, NPR 300 6.2ton medium truck	Front	⊥ ⊖
"66605MM"	ISUZU	97-on	FSR 700 F-C and FTR 800 F-C, FVR 900T F-C	Rear	⊥ T
"66618MM"	ISUZU	All	NKR series	Rear	○ ○
"66618MM"	ISUZU	All	NPR 275 5.8ton, NPR 300 6.2ton medium truck	Rear	○ ○
"66626MM"	ISUZU	97-on	FSR 700 F-C and FTR 800 F-C, FVR 900T F-C	Rear	⊥ T
"66626MM"	TATA	All	Tata 407 SFC 2T 4x2 F0-C	Rear	⊥ T
"66626MM"	TATA	All	Tata 509 M 4x2 F-C	Rear	⊥ T
"66626MM"	TATA	All	Tata 709 LPT 3T 4x2 F-C	Rear	⊥ T
"66626MM"	TATA	All	Tata 713 LPT S 4x2 F-C (incl 713 Bus)	Rear	⊥ T
"66653MM"	ISUZU	All	NPR 275 5.8ton, NPR 300 6.2ton medium truck	Front	⊥ ○
"66677MM"	ISUZU	All	NRR series	Front	⊥ ⊖
"66677MM"	ISUZU	97-on	FSR 700 F-C and FTR 800 F-C	Front	⊥ T
"66677MM"	ISUZU	97-on	FVR 900T F-C	Front	
"66717MM"	ISUZU	All	NPR 275 5.8ton, NPR 300 6.2ton medium truck	Front	⊥ ○
"74081MM"	ISUZU	97-on	FSR 700 F-C and FTR 800 F-C	Front	⊥ T
"74409"	KENWORTH	All	Kenworth Trucks: C500, C500B, C500K, C540, C55, K100, K100E, K125, T400, T400B, T450B, T600A, T600B, T602, T800A, T800B, T800SH, T800H, T800W, T2000 Aerodyne 112, 120, W900B, W900L, W900S.	Rear	⊥ T
"74409"	KENWORTH	All	Kenworth Trucks: K300, T300, T600, T800, W900	Rear	⊥ T
"74420"	INTERNATIONAL	All	International Trucks: 4900, 8100, 8200, 8300, 9100, 9200, 9300, 9400, 9600, 9700, 9900 (Check OE #s)	Rear	⊖ ⊖
"74433"	FREIGHTLINER	All	Freightliner Trucks: FLA, FLB COE truck & tractor, FLC112, FLD112, FLD120, Argosy range, FL112, Century Class C112, C120, Columbia Class FLC112, FLD112, FLD120, M2	Rear	⊖ ⊖
"74466MM"	TATA	All	Tata 709 LPT 3T 4x2 F-C	Front	⊥ T
"74466MM"	TATA	All	Tata 713 LPT S 4x2 F-C (incl 713 Bus)	Front	⊥ T
"B1278"	MAN	All	M90	Front	⊥ T
"B1278"	MAN	All	Man NG, NL, NU, EL Bus	Rear	⊥ T
"B1278"	VOLVO	All	F12 & F16	Front	⊥ T
"F5007"	BPW / BERISCHE ACHSEN	Check OE#s	BPW / Bergische Achsen Trailers	Rear	⊖ ⊖
"F5007"	CARDI	Check OE#s	Cardi Trailer	Rear	⊖ ⊖
"F5007"	LECITRAILER	All	Lecitrailer	Rear	⊖ ⊖
"F5015"	HENDRICKSON	All	Hendrickson trailer (various) [air susp]	Rear	⊖ ⊖
"T1005"	VOLVO	All	FL7 & FL10 & FL12	Front	⊖ ⊖
"T1011"	MERCEDES-BENZ	All	2031, 2035, 2038, 2044, 2055	Front	⊖ ⊖
"T1011"	MERCEDES-BENZ	All	1729S, 1732, 1735S, 1735 (incl Powerliner & Axor)	Front	⊖ ⊖
"T1011"	MERCEDES-BENZ	All	3028, 3033, 3035, 3036, 3228, Axor 3228C, 3235, 3238, 3244, 3335, 3534, 3535	Front	⊖ ⊖
"T1011"	MERCEDES-BENZ	All	Actros, Atego, Axor : 2223, 2224, 2225, 2226, 2228, 2229, 2232, 2233, 2235, 2236, 2238, 2244, 2426, 2428, 2429, 2432, 2435, 2436, 2438, 2448, 2531, 2534, 2535, 2538, 2540, 2543, 2544, 2548, 2550, 2553, 2623, 2626, 2628, 2629, 2632, 2633, 2635, 2636, 2638 (incl Powerliner)	Front	⊖ ⊖

Key

*	See important installation information on inside front cover
!	Excluding self-leveling suspension
"..."	Special order - phone 010 900 1850. 6-12 week waiting period

~	Imported
#	Internal bump stop
⊖	Steering damper

- It is recommended that all new shock absorbers are fitted in pairs
- Do not mix gas and non-gas units on the same axle
- **Bold** part numbers indicate heavy-duty shocks
- Underlined part numbers indicate parts not immediately available
- *Italic* part numbers followed by > indicate parts to be discontinued

Truck, bus and trailer

Part number [numerical listing]

Part number	Make	Year	Application	Position	Mounting information
SPECIAL ORDER					
"T1011"	MERCEDES-BENZ	All	Atego 1929, 1932, 1933, 1935, 1936, 1938, 1948	Front	⊖ ⊖
"T1011"	MERCEDES-BENZ	All	1922	Front	⊖ ⊖
"T1011"	MERCEDES-BENZ	All	Atego 1926, 1928	Front	⊖ ⊖
"T1011"	MERCEDES-BENZ	All	1838	Front	⊖ ⊖
"T1011"	MERCEDES-BENZ	All	1729, 1735, 1738, 1748, 1628, 1633, 1635, 1636, 1644	Front	⊖ ⊖
"T1028"	MAN	96-99	Man 14, 16, 19, 22, 26, 30, 32, 33, 38, 40, 41, 48 (Check OE #'s)	Front	⊥ ⊖
"T1028"	MAN	All	TGA: 18., 19., 24., 26., 28., 32., 33., 35., 40., 41.	Front	⊥ ⊖
"T1028"	MAN	All	Man 17, 22, 23, 26	Front	⊥ ⊖
"T1093"	MAN	All	M2000	Rear	⊥ T
"T1115"	MERCEDES-BENZ	All	1729, 1735, 1738, 1748	Rear	⊖ ⊖
"T1115"	MERCEDES-BENZ	All	Atego 1929, 1932, 1933, 1935, 1936, 1938, 1948	Rear	⊖ ⊖
"T1115"	MERCEDES-BENZ	All	Actros, Atego, Axor : 2223, 2224, 2225, 2226, 2228, 2229, 2232, 2233, 2235, 2236, 2238, 2244, 2426, 2428, 2429, 2432, 2435, 2436, 2438, 2448, 2531, 2534, 2535, 2538, 2540, 2543, 2544, 2548, 2550, 2553, 2623, 2626, 2628, 2629, 2632, 2633, 2635, 2636, 2638 (Powerliner)	Rear	⊖ ⊖
"T1179"	VOLVO	All	FH12	Front	⊖ ⊖
"T1179"	VOLVO	All	FH16, FH12	Rear	⊖ ⊖
"T1180"	VOLVO	All	FH12, FL180, FL220, FL250	Front	⊖ ⊖
"T1180"	VOLVO	All	FH16, FM9, FM12, FH12	Rear	⊖ ⊖
"T1189"	MAN	All	M2000	Front	⊥ ⊖
"T1193"	DAF		DAF FA & FT 95	Front	⊥ ⊖
"T1193"	DAF		DAF 75	Rear	⊥ ⊖
"T1197"	MERCEDES-BENZ	All	Atego, Actros & Axor 1823 -> 1857 Actros 1858, 1860	Front	⊖ ⊖
"T1197"	MERCEDES-BENZ	All	Actros, Axor: 3331, 3340, 3343, 3348, 3353	Front	⊖ ⊖
"T1197"	MERCEDES-BENZ	All	Actros 2031, 2040, 2053, 2531, 2535, 2540, 2543, 2548, 2631, 2635, 2640, 2643, 2648, 2653, 2657	Front	⊖ ⊖
"T1200"	MERCEDES-BENZ	All	2640, 2643, 2644, 2648, 2653	Rear	⊖ ⊖
"T1200"	MERCEDES-BENZ	All	2031, 2035, 2038, 2044, 2055	Rear	⊖ ⊖
"T1200"	MERCEDES-BENZ	All	Atego, Actros & Axor 1823 -> 1857 Actros 1858, 1860	Rear	⊖ ⊖
"T1200"	MERCEDES-BENZ	All	Actros, Atego, Axor : 2223, 2224, 2225, 2226, 2228, 2229, 2232, 2233, 2235, 2236, 2238, 2244, 2426, 2428, 2429, 2432, 2435, 2436, 2438, 2448, 2531, 2534, 2535, 2538, 2540, 2543, 2544, 2548, 2550, 2553, 2623, 2626, 2628, 2629, 2632, 2633, 2635, 2636, 2638 (Powerliner)	Rear	⊖ ⊖
"T1267"	MAN	All	TGA: 18., 19., 24., 26., 28., 32., 33., 35., 40., 41.	Front	⊥ ⊖
"T1268"	MAN	All	TGA: 18., 19., 24., 26., 28., 32., 33., 35., 40., 41.	Front	⊥ ⊖
"T5030" >	MERCEDES-BENZ	All	1722, 1724, 1726,	Rear	⊥ ⊖
"T5045"	DAF	Various	DAF 65 CF (front leaf, rear air susp)	Rear	⊖ ⊖
"T5045"	DAF		DAF 75	Rear	⊖ ⊖
"T5045"	DAF		DAF 85.340, 85.330, 85.430	Rear	⊖ ⊖
"T5045"	DAF	All	DAF FTS85 (CF85 series)	Rear	⊖ ⊖
"T5045"	DAF		DAF FA & FT 95	Rear	⊖ ⊖
"T5046"	DAF	Various	DAF FA 1900	Front	⊖ ⊖
"T5046"	DAF	Various	DAF 75	Rear	⊖ ⊖
"T5046"	DAF		DAF FA & FT 95	Rear	⊖ ⊖
"T5048"	MAN	All	TGA: 18., 19., 24., 26., 28., 32., 33., 35., 40., 41.	Rear	⊖ ⊖
"T5048"	MAN	96-99	Man 14, 16, 19, 22, 26, 30, 32, 33, 38, 40, 41, 48 (Check OE #'s)	Rear	⊖ ⊖
"T5070"	DAF		DAF 75	Rear	⊥ T

Key

*	See important installation information on inside front cover
!	Excluding self-levelling suspension
"..."	Special order - phone 010 900 1850, 6-12 week waiting period

~	Imported
#	Internal bump stop
⊖	Steering damper

- It is recommended that all new shock absorbers are fitted in pairs
- Do not mix gas and non-gas units on the same axle
- **Bold** part numbers indicate heavy-duty shocks
- Underlined part numbers indicate parts not immediately available
- *Italic* part numbers followed by > indicate parts to be discontinued

Truck, bus and trailer

Part number [numerical listing]

Part number	Make	Year	Application	Position	Mounting information
SPECIAL ORDER					
"T5070"	DAF		DAF FA & FT 95	Rear	⊥ T
"T5078"	RENAULT	94-on	Renault AE385Ti & AE420Ti	Rear	⊖ ⊖
"T5091"	VOLVO	All	FH16, FH12	Rear	⊖ T
"T5092"	VOLVO	All	F10, FL7 & FL10 & FL12	Front	⊖ ⊖
"T5092"	VOLVO	All	F12 & F16	Front	⊖ ⊖
"T5145"	SCANIA	All	Scania 93	Rear	⊖ ⊖
"T5145"	SCANIA	All	Scania 94, 124, 114, 144	Rear	⊖ ⊖
"T5154"	RENAULT	94-on	Renault AE385Ti & AE420Ti	Rear	⊖ ⊖
"T5169"	DAF	All	DAF FA & FT 95	Rear	○ ○
"T5169"	ERF	All	ERF Various trucks	Rear	○ ○
"T5170"	VOLVO	All	FH16, FM9, FM12, FH12	Rear	⊖ ⊖
"T5179"	RENAULT	94-on	Renault AE385Ti & AE420Ti	Front	⊥ T
"T5180"	DAF		DAF 65 CF (front leaf, rear air susp)	Rear	⊖ ⊖
"T5180"	DAF	Various	DAF 65 (front leaf, rear air susp)	Rear	⊖ ⊖
"T5180"	DAF		DAF 75	Rear	⊖ ⊖
"T5180"	DAF		DAF FTS85 (CF85 series), A & FT 95, 85.340, 85.330, 85.430	Rear	⊖ ⊖
"T5181"	DAF		DAF 75	Rear	⊥ T
"T5181"	DAF		DAF FTS85 (CF85 series)	Rear	⊥ T
"T5181"	DAF		DAF FA & FT 95	Rear	⊥ T
"T5181"	DAF	All	DAF 85.340, 85.330, 85.430	Rear	⊥ T
"T5182"	DAF		DAF FTS85 (CF85 series), A & FT 95, 85.340, 85.330, 85.430	Rear	⊖ ⊖
"T5182"	DAF		DAF 75	Rear	⊖ ⊖
"T5184"	VOLVO	All	FM7, FM9, FM, 12, FH16	Front	⊖ ⊖
"T5184"	VOLVO	All	FH12	Front	⊖ ⊖
"T5242"	SCANIA	All	Scania 94	Rear	⊥ T
"T5255"	DAF		DAF FA & FT 95	Rear	⊖ ⊖
"T5262"	MAN	All	TGA: 18., 19., 24., 26., 28., 32., 33., 35., 40., 41.	Rear	⊖ ⊖
"T5262"	MAN	All	TGX	Rear	⊖ ⊖
"T5262"	MAN	All	TGS: 18., 19., 24., 26., 28., 32., 33., 35., 40., 41.	Rear	⊖ ⊖
"T5263"	MAN	All	TGA: 18., 19., 24., 26., 28., 32., 33., 35., 40., 41.	Rear	⊖ ⊖
"T5263"	MAN	All	41	Rear	⊖ ⊖
"T5263"	MAN	All	Man 18, 19, 21	Rear	⊖ ⊖
"T5288"	DAF		DAF FTS85 (CF85 series)	Front	⊥ T
"T5356"	SCANIA	98-'04	Scania 4 Series	Front	⊥ T
"T5356"	SCANIA	All	Scania 94, 114, 124, 144, P, G, R, T - series	Front	⊥ T
"T5357"	DAF		DAF 75	Rear	⊖ ⊖ (Leaf spring susp)
"T5357"	DAF		DAF 85.340, 85.330, 85.430	Rear	⊖ ⊖ (Leaf spring susp)
"V1029"	NISSAN	69-76	A320, A321	Rear	○ T
"V1042"	Dyna	85-on	Dyna 100 (LH80, YH81, LY100)	Front	⊥ ○
"V2099"	RENAULT	All	Renault MIDLUM	Front	⊥ ⊖

Key

*	See important installation information on inside front cover
!	Excluding self-levelling suspension
"..."	Special order - phone 010 900 1850. 6-12 week waiting period

~	Imported
#	Internal bump stop
⊕	Steering damper

- It is recommended that all new shock absorbers are fitted in pairs
- Do not mix gas and non-gas units on the same axle
- **Bold** part numbers indicate heavy-duty shocks
- Underlined part numbers indicate parts not immediately available
- *Italic* part numbers followed by > indicate parts to be discontinued

Cab dampers

Part number [numerical listing]

Part number	Make	Year	Application	Position	Mounting information
66104MM	INTERNATIONAL		International Trucks: 4900, 8100, 8200, 8300, 9100, 9200, 9300, 9400, 9600, 9700, 9900 (Check OE #'s) CAB DAMPER	Front	⊖ ⊖
66104MM	KENWORTH		Kenworth Trucks: K300, T300, T600, T800, W900 CAB DAMPER	Front	⊖ ⊖
66104MM	KENWORTH		Kenworth Trucks: C500, C500B, C500K, C540, C55, K100, K100E, K125, T400, T400B, T450B, T600A, T600B, T602., T800A, T800B, T800SH, T800H, T800W, T2000 Aerodyne 112, 120, W900B, W900L, W900S. CAB DAMPER	Front	⊖ ⊖
66104MM	PETERBILT		Peterbilt Trucks: 330, 357, 362 COE, 365 COE Air susp, 372 COE, 375, 376, 377, 378, 379, 385, 387 CAB DAMPER	Front	⊖ ⊖
66104MM	FREIGHTLINER		Freightliner Trucks: FLA, FLB COE truck & tractor, FLC112, FLD112, FLD120 CAB DAMPER	Front	⊖ ⊖
66104MM	FREIGHTLINER	All	Freightliner FL60, FL70 CAB DAMPER	Front	⊖ ⊖
66105MM	FREIGHTLINER	All	Freightliner Trucks: Argosy range, FL112, Century Class C112, C120, Columbia Class FLC112, FLD112, FLD120, M2	Front	⊖ ⊖
66118MM >	FREIGHTLINER	All	Freightliner FL60, FL70 CAB DAMPER	Front	⊖ ⊖
66118MM >	FREIGHTLINER	All	Freightliner C112, C120 CAB DAMPER	Front	⊖ ⊖
66147MM	FREIGHTLINER		Freightliner Trucks: FLA, FLB COE truck & tractor, FLC112, FLD112, FLD120 CAB DAMPER	Front	⊖ ⊖
66147MM	FREIGHTLINER	All	Freightliner FL60, FL70 CAB DAMPER	Front	⊖ ⊖
66147MM	FREIGHTLINER	All	Freightliner C112, C120 CAB DAMPER	Front	⊖ ⊖
66161MM	INTERNATIONAL		International Trucks 7300, 7400, 7500, 7600 series CAB DAMPER	Front	⊖ ⊖
66161MM	INTERNATIONAL		International Trucks: 4900, 8100, 8200, 8300, 9100, 9200, 9300, 9400, 9600, 9700, 9900 (Check OE #'s) CAB DAMPER	Front	⊖ ⊖
66161MM	INTERNATIONAL		International Trucks: 5500i, 5600i, 5900i (HAS-230 susp), / 7300, 7400, 7500, 7600 (Drive axles) / 9100i, 9200i, 9400i (HAS-230/400/460 susp Drive Axles) / 9900i, 9900ix (HAS-230/400/460 susp Drive Axles) – Check OE #'s) CAB DAMPER	Front	⊖ ⊖
66162MM	FREIGHTLINER	All	Freightliner C112, C120 CAB DAMPER	Front	⊖ ⊖
66162MM	INTERNATIONAL		International Trucks 7300, 7400, 7500, 7600 series CAB DAMPER	Front	⊖ ⊖
66162MM	INTERNATIONAL		International Trucks: 4900, 8100, 8200, 8300, 9100, 9200, 9300, 9400, 9600, 9700, 9900 (Check OE #'s) CAB DAMPER	Front	⊖ ⊖
66162MM	INTERNATIONAL		International Trucks: 5500i, 5600i, 5900i (HAS-230 susp), / 7300, 7400, 7500, 7600 (Drive axles) / 9100i, 9200i, 9400i (HAS-230/400/460 susp Drive Axles) / 9900i, 9900ix (HAS-230/400/460 susp Drive Axles) – Check OE #'s) CAB DAMPER	Front	⊖ ⊖
CB0001	VOLVO	All	FM9, FM12, FH12, FH16 Cabin Damper	Rear	⊖ ⊖
CB0004	VOLVO	All	FM9, FM12, FH12, FH16 Cabin Damper	Front	⊖ ⊖
CB0006	VOLVO	All	FH12, FH16 Cabin Damper	Front	⊖ ⊖
CB0006	VOLVO	All	FH12, FH16 Cabin Damper	Rear	⊖ ⊖
CB0007	VOLVO	All	FM12, FH12, FH16 Cabin Damper	Front	⊖ ⊖
CB0007	VOLVO	All	FM7, FM9 Cabin Damper	Front	⊖ ⊖
CB0007	VOLVO	All	FM10 Cabin Damper	Front	⊖ ⊖
CB0009	SCANIA	All	Scania 94, 114, 124, 144 & 164 CAB DAMPER	Rear	⊥ ⊖
CB0010	SCANIA	All	94, 114, 144 & 164 CAB DAMPER	Front	⊥ T
CB0010	SCANIA		Scania P, G, R, T – series, 124 Cab Damper,	Front	⊥ T
CB0010	SCANIA	All	Scania 94, 114, 124, 144 & 164 CAB DAMPER	Rear	⊥ T
CB0011	SCANIA	All	95, 114, 144 & 164 CAB DAMPER	Front	⊥ T
CB0011	SCANIA	All	124 Cab Damper	Front	⊥ T
CB0011	SCANIA	All	Scania 94, 114, 124, 144 & 164 CAB DAMPER	Rear	⊥ T
CB0015	SCANIA	All	Scania 93 Cab Damper	Rear	⊥ ⊖
CB0015	SCANIA	All	Scania 113 Cab Damper	Rear	⊥ ⊖
CB0015	SCANIA	All	Scania 143 Cab Damper	Rear	⊥ ⊖
CB0017	VOLVO	All	FL7 & FL10 & FL12	Rear	⊥ T
CB0019	VOLVO	All	FH12, FH16 Cabin Damper	Rear	⊖ ⊖

Key

*	See important installation information on inside front cover
!	Excluding self-levelling suspension
"..."	Special order – phone 010 900 1850. 6-12 week waiting period

~	Imported
#	Internal bump stop
⊖	Steering damper

- It is recommended that all new shock absorbers are fitted in pairs
- Do not mix gas and non-gas units on the same axle
- **Bold** part numbers indicate heavy-duty shocks
- Underlined part numbers indicate parts not immediately available
- *Italic* part numbers followed by > indicate parts to be discontinued

Cab dampers

Part number [numerical listing]

Part number	Make	Year	Application	Position	Mounting information
CB0029	VOLVO	All	FH12, FH16 Cabin Damper	Rear	⊖ ⊖
CB0030	SCANIA	All	96, 114, 144 & 164 CAB DAMPER	Front	Air Bellows
CB0030	SCANIA		Scania P, G, R, T – series, 124 Cab Damper,	Front	⊥ T
CB0030	SCANIA	All	Scania 94, 114, 124, 144 & 164 CAB DAMPER	Rear	⊥ ⊖
CB0040	VOLVO	All	FM9, FM12, FH12 Cabin Damper	Front	⊥ ⊖
CB0046	RENAULT	All	Renault KERAX trucks 2544K, 2544L, 2644, 2644AK, 2650, 3235, 3235K, Plus PREMIUM trucks	Front	⊖ ⊖
CB0046	VOLVO	All	FE	Front	⊖ ⊖
CB0055	VOLVO	All	FM9, FM12, FH12, FH16 Cabin Damper	Front	⊥ ⊖
CB0058	SCANIA	All	96, 114, 144 & 164 CAB DAMPER	Front	⊥ T
CB0058	SCANIA		Scania P, G, R, T – series, 124 Cab Damper,	Front	⊥ ⊖
CB0059	SCANIA	All	Scania 94, 114, 124, 144 & 164 CAB DAMPER	Rear	⊥ T
CB0064	RENAULT	All	Renault PREMIUM trucks	Rear	⊖ ⊖
CB0064	RENAULT	All	Renault KERAX trucks 2544K, 2544L, 2644, 2644AK, 2650, 3235, 3235K	Rear	⊖ ⊖
CB0064	VOLVO	All	FE	Rear	⊖ ⊖
CB0065	SCANIA	98-'04	Scania 3 Series, 4 Series	Rear	⊥ ⊖
CB0065	SCANIA	98-'04	Scania 4 Series	Front	⊥ ⊖
CB0066	SCANIA	98-'04	Scania 4 Series	Front	⊥ T
CB0066	SCANIA	98-'04	Scania 3 Series, 4 Series	Rear	⊥ ⊖
CB0067	SCANIA	All	96, 114, 144 & 164 CAB DAMPER	Front	Air Bellows
CB0067	SCANIA		Scania P, G, R, T – series, Cab damper	Rear	⊥ ⊖
CB0067	SCANIA		Scania P, G, R, T – series, 124 Cab Damper,	Front	⊥ T
CB0067	SCANIA	All	Scania 94, 114, 124, 144 & 164 CAB DAMPER	Rear	⊥ ⊖
CB0071	MERCEDES-BENZ	All	1729, 1735, 1738, 1748, 1628, 1633, 1635, 1636, 1644	Front	⊖ ⊖
CB0071	MERCEDES-BENZ	All	Actros, Atego, Axor : 2223, 2224, 2225, 2226, 2228, 2229, 2232, 2233, 2235, 2236, 2238, 2244, 2426, 2428, 2429, 2432, 2435, 2436, 2438, 2448, 2531, 2534, 2535, 2538, 2540, 2543, 2544, 2548, 2550, 2553, 2623, 2626, 2628, 2629, 2632, 2633, 2635, 2636, 2638 (INCL Powerliner)	Front	⊖ ⊖
CB0071	MERCEDES-BENZ	All	Actros, Atego, Axor : 2223, 2224, 2225, 2226, 2228, 2229, 2232, 2233, 2235, 2236, 2238, 2244, 2426, 2428, 2429, 2432, 2435, 2436, 2438, 2448, 2531, 2534, 2535, 2538, 2540, 2543, 2544, 2548, 2550, 2553, 2623, 2626, 2628, 2629, 2632, 2633, 2635, 2636, 2638 (INCL Powerliner)	Rear	⊖ ⊖
CB0071	MERCEDES-BENZ	All	1844, 1850	Rear	⊖ ⊖
CB0071	MERCEDES-BENZ	All	1638, 1844, 1850	Front	⊖ ⊖
CB0071	MERCEDES-BENZ	All	1729S, 1732, 1735S, 1735 (INCL Powerliner & Axor)	Rear	⊖ ⊖
CB0071	MERCEDES-BENZ	All	Atego 1929, 1932, 1933, 1935, 1936, 1938, 1948	Front	⊖ ⊖
CB0071	MERCEDES-BENZ	All	1729, 1735, 1738, 1748	Rear	⊖ ⊖
CB0071	MERCEDES-BENZ	All	Atego 1929, 1932, 1933, 1935, 1936, 1938, 1948	Rear	⊖ ⊖
CB0071	MERCEDES-BENZ	All	1838	Front	⊖ ⊖
CB0071	MERCEDES-BENZ	All	1638,	Rear	⊖ ⊖
CB0071	MERCEDES-BENZ	All	1838	Rear	⊖ ⊖
CB0071	MERCEDES-BENZ	All	1628, 1633, 1635, 1636, 1644	Rear	⊖ ⊖
CB0074	SCANIA		Scania P, G, R, T – series, Cab damper	Rear	⊥ ⊖
CB0074	SCANIA	All	Scania 94, 114, 124, 144 & 164 CAB DAMPER	Rear	⊥ ⊖
CB0075	RENAULT	All	Renault KERAX trucks 2544K, 2544L, 2644, 2644AK, 2650, 3235, 3235K, Plus PREMIUM trucks	Front	⊖ ⊖
CB0078	SCANIA		Scania P, G, R, T – series, Cab damper	Front	⊥ ⊖
CB0078	SCANIA	All	Scania 94, 114, 124, 144 & 164 CAB DAMPER	Rear	⊥ ⊖
CB0090	MERCEDES-BENZ	All	Atego, Actros & Axor 1823 -> 1857 Actros 1858, 1860	Rear	⊖ ⊖

Key

*	See important installation information on inside front cover
!	Excluding self-levelling suspension
"..."	Special order – phone 010 900 1850. 6-12 week waiting period

~	Imported
#	Internal bump stop
⊖	Steering damper

- It is recommended that all new shock absorbers are fitted in pairs
- Do not mix gas and non-gas units on the same axle
- **Bold** part numbers indicate heavy-duty shocks
- Underlined part numbers indicate parts not immediately available
- *Italic* part numbers followed by > indicate parts to be discontinued

Cab dampers

Part number [numerical listing]

Part number	Make	Year	Application	Position	Mounting information
CB0090	MERCEDES-BENZ	All	Actros 2031, 2040, 2053, 2531, 2535, 2540, 2543, 2548, 2631, 2635, 2640, 2643, 2648, 2653, 2657	Rear	⊖ ⊖
CB0090	MERCEDES-BENZ	All	Actros 3231, 3232, 3241, 3246, 3248, 3332, 3336, 3341, 3344, 3346, 3350, 3351, 3354, 3355, 3357, 3360	Rear	⊖ ⊖
CB0092	MAN	All	F2000	Front	⊖ ⊥
CB0096	MERCEDES-BENZ	All	Atego, Actros & Axor 1823 -> 1857 Actros 1858, 1860	Rear	⊖ ⊖
CB0096	MERCEDES-BENZ	All	Actros, Axor: 3331, 3340, 3343, 3348, 3353	Rear	⊖ ⊖
CB0096	MERCEDES-BENZ	All	Actros 2031, 2040, 2053, 2531, 2535, 2540, 2543, 2548, 2631, 2635, 2640, 2643, 2648, 2653, 2657	Rear	⊖ ⊖
CB0096	MERCEDES-BENZ	All	Actros, Atego, Axor : 2223, 2224, 2225, 2226, 2228, 2229, 2232, 2233, 2235, 2236, 2238, 2244, 2426, 2428, 2429, 2432, 2435, 2436, 2438, 2448, 2531, 2534, 2535, 2538, 2540, 2543, 2544, 2548, 2550, 2553, 2623, 2626, 2628, 2629, 2632, 2633, 2635, 2636, 2638 (M Powerliner)	Rear	⊖ ⊖
CB0096	MERCEDES-BENZ	All	Actros 3231, 3232, 3241, 3246, 3248, 3332, 3336, 3341, 3344, 3346, 3350, 3351, 3354, 3355, 3357, 3360	Rear	⊖ ⊖
CB0096	MERCEDES-BENZ	All	Actros, Atego, Axor : 2523, 2528, 2532, 2536, 2541, 2544, 2546, 2548, 2551, 2555, 2560	Rear	⊖ ⊖
CB0096	MERCEDES-BENZ	All	Actros, Atego, Axor 2628, 2629, 2632, 2633, 2636, 2641, 2644, 2646, 2650, 2651, 2654, 2655, 2658, 2932	Rear	⊖ ⊖
CB0096	MERCEDES-BENZ	All	Actros 2032, 2036, 2041, 2044, 2046, 2050, 2051	Rear	⊖ ⊖
CB0100	MERCEDES-BENZ	All	Atego, Actros & Axor 1823 -> 1857 Actros 1858, 1860	Front	⊖ ⊖
CB0100	MERCEDES-BENZ	All	Actros 2031, 2040, 2053, 2531, 2535, 2540, 2543, 2548, 2631, 2635, 2640, 2643, 2648, 2653, 2657	Front	⊖ ⊖
CB0100	MERCEDES-BENZ	All	Actros, Atego, Axor : 2523, 2528, 2532, 2536, 2541, 2544, 2546, 2548, 2551, 2555, 2560	Front	⊖ ⊖
CB0100	MERCEDES-BENZ	All	Actros, Atego, Axor : 2223, 2224, 2225, 2226, 2228, 2229, 2232, 2233, 2235, 2236, 2238, 2244, 2426, 2428, 2429, 2432, 2435, 2436, 2438, 2448, 2531, 2534, 2535, 2538, 2540, 2543, 2544, 2548, 2550, 2553, 2623, 2626, 2628, 2629, 2632, 2633, 2635, 2636, 2638 (M Powerliner)	Front	⊖ ⊖
CB0100	MERCEDES-BENZ	All	Actros, Axor: 3331, 3340, 3343, 3348, 3353	Front	⊖ ⊖
CB0100	MERCEDES-BENZ	All	Actros 3231, 3232, 3241, 3246, 3248, 3332, 3336, 3341, 3344, 3346, 3350, 3351, 3354, 3355, 3357, 3360, Actros 4140, 4144, 4148	Front	⊖ ⊖
CB0100	MERCEDES-BENZ	All	Actros, Atego, Axor 2628, 2629, 2632, 2633, 2636, 2641, 2644, 2646, 2650, 2651, 2654, 2655, 2658, 2932	Front	⊖ ⊖
CB0100	MERCEDES-BENZ	All	Actros 2032, 2036, 2041, 2044, 2046, 2050, 2051	Front	⊖ ⊖
CB0101	MERCEDES-BENZ	All	Atego, Actros & Axor 1823 -> 1857 Actros 1858, 1860	Rear	⊖ ⊖
CB0101	MERCEDES-BENZ	All	1853, 1857	Rear	⊖ ⊖
CB0101	MERCEDES-BENZ	All	1838	Rear	⊖ ⊖
CB0103	MAN	All	L2000	Rear	⊖ ⊖
CB0103	MAN	All	M90	Rear	⊖ ⊖
CB0103	MAN	All	TGA: 18., 19., 24., 26., 28., 32., 33., 35., 40., 41.	Rear	⊖ ⊖
CB0103	MAN	All	F2000	Rear	⊖ ⊖
CB0103	MAN	All	M2000	Rear	⊖ ⊖
CB0104	MERCEDES-BENZ	All	2220, L, LA, LS, LAS	Rear	⊥ ○
CB0104	MERCEDES-BENZ	All	Atego 1317, 1318, 1322, 1323, 1324, 1326, 1328, 1329	Rear	⊥ ⊗
CB0104	MERCEDES-BENZ	All	1413, 1413K, 1414, 1417, 1417K, 1419, 1419K, 1419S, 1420, 1422, 1424, 1425, 1426, 1427, 1428, 1613, 1614, 1617, 1619, 1620, 1622	Rear	⊥ ○
CB0104	MERCEDES-BENZ	All	Atego, 1013, 1017, 1019, 1213, 1214, 1215, 1216, 1217, 2018, 1219, 1222, 1223, 1224, 1225, 1226, 1228, 1229, 1420, 1422, 1424	Rear	⊥ ○
CB0104	MERCEDES-BENZ	All	Actros, Atego, Axor : 2223, 2224, 2225, 2226, 2228, 2229, 2232, 2233, 2235, 2236, 2238, 2244, 2426, 2428, 2429, 2432, 2435, 2436, 2438, 2448, 2531, 2534, 2535, 2538, 2540, 2543, 2544, 2548, 2550, 2553, 2623, 2626, 2628, 2629, 2632, 2633, 2635, 2636, 2638 (M Powerliner)	Rear	⊥ ○
CB0104	MERCEDES-BENZ	All	3028, 3033, 3035, 3036, 3228, Axor 3228C, 3235, 3238, 3244, 3335, 3534, 3535	Rear	⊥ ⊗
CB0104 >	MERCEDES-BENZ	All	Atego 1926, 1928	Rear	⊥ ○
CB0104 >	MERCEDES-BENZ	All	1626, 1628, 1632, 1922, 1919, 1719, 1633, 1635, 1636, 1644	Rear	⊥ ○
CB0105	MAN	All	L2000	Rear	⊖ ⊖
CB0105	MAN	All	F2000	Rear	⊖ ⊖
CB0105	MAN	All	F90	Rear	⊖ ⊖

Key

*	See important installation information on inside front cover
!	Excluding self-levelling suspension
"..."	Special order - phone 010 900 1850. 6-12 week waiting period

~	Imported
#	Internal bump stop
⊖	Steering damper

- It is recommended that all new shock absorbers are fitted in pairs
- Do not mix gas and non-gas units on the same axle
- **Bold** part numbers indicate heavy-duty shocks
- Underlined part numbers indicate parts not immediately available
- *Italic* part numbers followed by > indicate parts to be discontinued

Cab dampers

Part number [numerical listing]

Part number	Make	Year	Application	Position	Mounting information
CB0105	SCANIA	All	Scania 35, 41	Rear	\
CB0106	MAN	All	F2000	Front	⊖ T
CB0106	MAN	All	L2000	Front	⊖ T
CB0109	RENAULT	All	Renault PREMIUM trucks	Rear	⊖ ⊖
CB0109	RENAULT	All	Renault KERAX trucks 2544K, 2544L, 2644, 2644AK, 2650, 3235, 3235K	Rear	⊖ ⊖
CB0109	VOLVO	All	FE	Rear	⊖ ⊖
CB0118	RENAULT	All	Renault PREMIUM trucks	Rear	⊥ ⊗
CB0118	VOLVO	All	FE	Rear	⊥ ⊗
CB0118	RENAULT	All	Renault KERAX trucks 2544K, 2544L, 2644, 2644AK, 2650, 3235, 3235K	Rear	⊥ ⊗
CB0122	MERCEDES-BENZ	All	Atego, Actros & Axor 1823 -> 1857 Actros 1858, 1860	Front	⊖ ⊖
CB0122	MERCEDES-BENZ	All	Actros 2031, 2040, 2053, 2531, 2535, 2540, 2543, 2548, 2631, 2635, 2640, 2643, 2648, 2653, 2657	Front	⊖ ⊖
CB0122	MERCEDES-BENZ	All	Actros 3231, 3232, 3241, 3246, 3248, 3332, 3336, 3341, 3344, 3346, 3350, 3351, 3354, 3355, 3357, 3360, Actros 4140, 4144, 4148	Front	⊖ ⊖
CB0127	MERCEDES-BENZ	All	Actros, Atego, Axor : 2223, 2224, 2225, 2226, 2228, 2229, 2232, 2233, 2235, 2236, 2238, 2244, 2426, 2428, 2429, 2432, 2435, 2436, 2438, 2448, 2531, 2534, 2535, 2538, 2540, 2543, 2544, 2548, 2550, 2553, 2623, 2626, 2628, 2629, 2632, 2633, 2635, 2636, 2638 (incl Powerliner)	Front	⊖ ⊖
CB0127	MERCEDES-BENZ	All	Atego, Actros & Axor 1823 -> 1857 Actros 1858, 1860	Front	⊖ ⊖
CB0127	MERCEDES-BENZ	All	Actros, Atego, Axor 2628, 2629, 2632, 2633, 2636, 2641, 2644, 2646, 2650, 2651, 2654, 2655, 2658, 2932	Front	⊖ ⊖
CB0129	MERCEDES-BENZ	All	Actros, Atego, Axor : 2223, 2224, 2225, 2226, 2228, 2229, 2232, 2233, 2235, 2236, 2238, 2244, 2426, 2428, 2429, 2432, 2435, 2436, 2438, 2448, 2531, 2534, 2535, 2538, 2540, 2543, 2544, 2548, 2550, 2553, 2623, 2626, 2628, 2629, 2632, 2633, 2635, 2636, 2638 (incl Powerliner)	Front	⊖ ⊖
CB0129	MERCEDES-BENZ	All	Atego, Actros & Axor 1823 -> 1857 Actros 1858, 1860	Front	⊖ ⊖
CB0129	MERCEDES-BENZ	All	Actros 2031, 2040, 2053, 2531, 2535, 2540, 2543, 2548, 2631, 2635, 2640, 2643, 2648, 2653, 2657	Front	⊖ ⊖
CB0129	MERCEDES-BENZ	All	Actros 3231, 3232, 3241, 3246, 3248, 3332, 3336, 3341, 3344, 3346, 3350, 3351, 3354, 3355, 3357, 3360, Actros 4140, 4144, 4148	Front	⊖ ⊖
CB0129	MERCEDES-BENZ	All	Actros, Atego, Axor 2628, 2629, 2632, 2633, 2636, 2641, 2644, 2646, 2650, 2651, 2654, 2655, 2658, 2932	Front	⊖ ⊖
CB0130	SCANIA	All	96, 114, 144 & 164 CAB DAMPER	Front	Air Bellows
CB0130	SCANIA		Scania P, G, R, T - series, 124 Cab Damper,	Front	⊥ T
CB0130	SCANIA	All	Scania 94, 114, 124, 144 & 164 CAB DAMPER	Rear	⊥ ⊖
CB0130	SCANIA		Scania P, G, R, T - series, Cab damper	Rear	⊥ ⊖
CB0134	SCANIA		Scania P, G, R, T - series, Cab damper	Rear	⊥ ⊖
CB0134	SCANIA	All	Scania 94, 114, 124, 144 & 164 CAB DAMPER	Rear	⊥ ⊖
CB0136	IVECO	All	Stralis 190Sxx Series, 260Sxx Series, 320Sxx Series, 440Sxx Series	Rear	⊖ ⊖
CB0137	IVECO	All	Stralis 190Sxx Series, 260Sxx Series, 320Sxx Series, 440Sxx Series	Front	⊖ ⊖
CB0139	MAN	All	L2000	Rear	⊖ ⊖
CB0139	MAN	All	M90	Rear	⊖ ⊖
CB0139	MAN	All	TGA: 18., 19., 24., 26., 28., 32., 33., 35., 40., 41.	Rear	⊖ ⊖
CB0139	MAN	All	M2000	Rear	⊖ ⊖
CB0140	RENAULT	All	Renault KERAX trucks 2544K, 2544L, 2644, 2644AK, 2650, 3235, 3235K	Rear	⊥ ⊗
CB0140	MERCEDES-BENZ	All	MK, NG, SK	Rear	⊥ ⊗
CB0141	MAN	All	TGA: 18., 19., 24., 26., 28., 32., 33., 35., 40., 41.	Rear	⊖ ⊖
CB0141	MAN	All	Man 13.192U, 14.192U, 15.192U, 16.291, 16.320U, 16.321, 16.321U, 16.321UL, 16.361, 17.220FA, 17.240FA, 19.291, 19.320U, 19.321, 19.321U, 19.361, 22.291UNL/LL, 22.320UNL, 22.321UNL, 22.331UNL/LL, 22.361UNL/LL, 24.291UNL/LL, 24.331UNL/LL, 24.361UNL/LL, 25.291UNL/LL, 25.331UNL/LL, 25.361UNL/LL, 26.291UNL/LL, 26.331UNL/LL, 26.361UNL/LL	Front	⊖ ⊖
CB0141	MAN	All	L2000	Rear	⊖ ⊖

Key

*	See important installation information on inside front cover
!	Excluding self-levelling suspension
"..."	Special order - phone 010 900 1850. 6-12 week waiting period

~	Imported
#	Internal bump stop
⊖	Steering damper

- It is recommended that all new shock absorbers are fitted in pairs
- Do not mix gas and non-gas units on the same axle
- **Bold** part numbers indicate heavy-duty shocks
- Underlined part numbers indicate parts not immediately available
- *Italic* part numbers followed by > indicate parts to be discontinued

Cab dampers

Part number [numerical listing]

Part number	Make	Year	Application	Position	Mounting information
CB0141	MAN	All	M90	Rear	⊖ ⊖
CB0148	MERCEDES-BENZ	All	Actros, Atego, Axor : 2223, 2224, 2225, 2226, 2228, 2229, 2232, 2233, 2235, 2236, 2238, 2244, 2426, 2428, 2429, 2432, 2435, 2436, 2438, 2448, 2531, 2534, 2535, 2538, 2540, 2543, 2544, 2548, 2550, 2553, 2623, 2626, 2628, 2629, 2632, 2633, 2635, 2636, 2638 (M) Powerliner)	Front	⊖ ⊖
CB0148	MERCEDES-BENZ	All	Atego, Actros & Axor 1823 -> 1857 Actros 1858, 1860	Front	⊖ ⊖
CB0148	MERCEDES-BENZ	All	Actros, Axor: 3331, 3340, 3343, 3348, 3353	Front	⊖ ⊖
CB0148	MERCEDES-BENZ	All	Actros 2031, 2040, 2053, 2531, 2535, 2540, 2543, 2548, 2631, 2635, 2640, 2643, 2648, 2653, 2657	Front	⊖ ⊖
CB0148	MERCEDES-BENZ	All	Actros 3231, 3232, 3241, 3246, 3248, 3332, 3336, 3341, 3344, 3346, 3350, 3351, 3354, 3355, 3357, 3360, Actros 4140, 4144, 4148	Front	⊖ ⊖
CB0148	MERCEDES-BENZ	All	Actros, Atego, Axor 2628, 2629, 2632, 2633, 2636, 2641, 2644, 2646, 2650, 2651, 2654, 2655, 2658, 2932	Front	⊖ ⊖
CB0148	MERCEDES-BENZ	All	Actros 2032, 2036, 2041, 2044, 2046, 2050, 2051	Front	⊖ ⊖
CB0148	MERCEDES-BENZ	All	Actros, Atego, Axor : 2523, 2528, 2532, 2536, 2541, 2544, 2546, 2548, 2551, 2555, 2560	Front	⊖ ⊖
CB0149	IVECO	All	Stralis 190Sxx Series, 260Sxx Series, 320Sxx Series, 440Sxx Series	Rear	⊖ ⊖
CB0149	MAN	All	Man Trakker 180Txx Series, 190Txx Series, 260Txx Series, 340Txx Series, 380Txx Series, 400Txx Series, 410Txx Series, 440Txx Series, 720Txx Series	Rear	⊖ ⊖
CB0150	MERCEDES-BENZ	All	Atego, Actros & Axor 1823 -> 1857 Actros 1858, 1860	Rear	⊖ ⊖
CB0150	MERCEDES-BENZ	All	Actros, Atego, Axor : 2223, 2224, 2225, 2226, 2228, 2229, 2232, 2233, 2235, 2236, 2238, 2244, 2426, 2428, 2429, 2432, 2435, 2436, 2438, 2448, 2531, 2534, 2535, 2538, 2540, 2543, 2544, 2548, 2550, 2553, 2623, 2626, 2628, 2629, 2632, 2633, 2635, 2636, 2638 (M) Powerliner)	Rear	⊖ ⊖
CB0150	MERCEDES-BENZ	All	Actros, Atego, Axor : 2523, 2528, 2532, 2536, 2541, 2544, 2546, 2548, 2551, 2555, 2560	Rear	⊖ ⊖
CB0150	MERCEDES-BENZ	All	Axor, Atego : 2523, 2528, 2529, 2533	Rear	⊖ ⊖
CB0150	MERCEDES-BENZ	All	Actros, Atego, Axor 2628, 2629, 2632, 2633, 2636, 2641, 2644, 2646, 2650, 2651, 2654, 2655, 2658, 2932	Rear	⊖ ⊖
CB0150	MERCEDES-BENZ	68-88	LK/LN2 3240, 3243, 3335, 3340, 3343	Rear	⊖ ⊖
CB0150	MERCEDES-BENZ	All	3028, 3033, 3035, 3036, 3228, Axor 3228C, 3235, 3238, 3244, 3335, 3534, 3535	Rear	⊖ ⊖
CB0152	IVECO	All	Stralis 190Sxx Series, 260Sxx Series, 320Sxx Series, 440Sxx Series	Rear	⊖ ⊖
CB0152	MAN	All	Man Trakker 180Txx Series, 190Txx Series, 260Txx Series, 340Txx Series, 380Txx Series, 400Txx Series, 410Txx Series, 440Txx Series, 720Txx Series	Rear	⊖ ⊖
CB0154	IVECO	All	Stralis 190Sxx Series, 260Sxx Series, 320Sxx Series, 440Sxx Series	Front	⊖ ⊖
CB0154	MAN	All	Man Trakker 180Txx Series, 190Txx Series, 260Txx Series, 340Txx Series, 380Txx Series, 400Txx Series, 410Txx Series, 440Txx Series, 720Txx Series	Front	⊖ ⊖
CB0155	MERCEDES-BENZ	All	Actros 2032, 2036, 2041, 2044, 2046, 2050, 2051	Rear	⊖ ⊖
CB0155	MERCEDES-BENZ	All	Actros 2031, 2040, 2053, 2531, 2535, 2540, 2543, 2548, 2631, 2635, 2640, 2643, 2648, 2653, 2657	Rear	⊖ ⊖
CB0155	MERCEDES-BENZ	All	Actros, Atego, Axor : 2523, 2528, 2532, 2536, 2541, 2544, 2546, 2548, 2551, 2555, 2560	Rear	⊖ ⊖
CB0155	MERCEDES-BENZ	All	Actros, Atego, Axor 2628, 2629, 2632, 2633, 2636, 2641, 2644, 2646, 2650, 2651, 2654, 2655, 2658, 2932	Rear	⊖ ⊖
CB0156	MERCEDES-BENZ	All	Actros 2032, 2036, 2041, 2044, 2046, 2050, 2051	Rear	⊖ ⊖
CB0156	MERCEDES-BENZ	All	Atego, Actros & Axor 1823 -> 1857 Actros 1858, 1860	Rear	⊖ ⊖
CB0156	MERCEDES-BENZ	All	Actros 2031, 2040, 2053, 2531, 2535, 2540, 2543, 2548, 2631, 2635, 2640, 2643, 2648, 2653, 2657	Rear	⊖ ⊖
CB0156	MERCEDES-BENZ	All	Actros, Atego, Axor : 2223, 2224, 2225, 2226, 2228, 2229, 2232, 2233, 2235, 2236, 2238, 2244, 2426, 2428, 2429, 2432, 2435, 2436, 2438, 2448, 2531, 2534, 2535, 2538, 2540, 2543, 2544, 2548, 2550, 2553, 2623, 2626, 2628, 2629, 2632, 2633, 2635, 2636, 2638 (M) Powerliner)	Rear	⊖ ⊖
CB0156	MERCEDES-BENZ	All	Actros 3231, 3232, 3241, 3246, 3248, 3332, 3336, 3341, 3344, 3346, 3350, 3351, 3354, 3355, 3357, 3360	Rear	⊖ ⊖
CB0156	MERCEDES-BENZ	All	Actros, Atego, Axor : 2523, 2528, 2532, 2536, 2541, 2544, 2546, 2548, 2551, 2555, 2560	Rear	⊖ ⊖
CB0156	MERCEDES-BENZ	All	Actros, Atego, Axor 2628, 2629, 2632, 2633, 2636, 2641, 2644, 2646, 2650, 2651, 2654, 2655, 2658, 2932	Rear	⊖ ⊖
CB0158	MERCEDES-BENZ	All	Actros 2031, 2040, 2053, 2531, 2535, 2540, 2543, 2548, 2631, 2635, 2640, 2643, 2648, 2653, 2657	Rear	⊖ ⊖
CB0163	MERCEDES-BENZ	All	Actros, Atego, Axor : 2223, 2224, 2225, 2226, 2228, 2229, 2232, 2233, 2235, 2236, 2238, 2244, 2426, 2428, 2429, 2432, 2435, 2436, 2438, 2448, 2531, 2534, 2535, 2538, 2540, 2543, 2544, 2548, 2550, 2553, 2623, 2626, 2628, 2629, 2632, 2633, 2635, 2636, 2638 (M) Powerliner)	Front	⊖ ⊖
CB0163	MERCEDES-BENZ	All	Atego, Actros & Axor 1823 -> 1857 Actros 1858, 1860	Front	⊖ ⊖

Key

*	See important installation information on inside front cover
!	Excluding self-levelling suspension
...	Special order - phone 010 900 1850. 6-12 week waiting period

~	Imported
#	Internal bump stop
⊖	Steering damper

- It is recommended that all new shock absorbers are fitted in pairs
- Do not mix gas and non-gas units on the same axle
- **Bold** part numbers indicate heavy-duty shocks
- Underlined part numbers indicate parts not immediately available
- *Italic* part numbers followed by > indicate parts to be discontinued

Cab dampers

Part number [numerical listing]

Part number	Make	Year	Application	Position	Mounting information
CB0163	MERCEDES-BENZ	All	Actros, Atego, Axor : 2523, 2528, 2532, 2536, 2541, 2544, 2546, 2548, 2551, 2555, 2560	Front	⊖ ⊖
CB0164	MERCEDES-BENZ	All	Actros, Atego, Axor : 2223, 2224, 2225, 2226, 2228, 2229, 2232, 2233, 2235, 2236, 2238, 2244, 2426, 2428, 2429, 2432, 2435, 2436, 2438, 2448, 2531, 2534, 2535, 2538, 2540, 2543, 2544, 2548, 2550, 2553, 2623, 2626, 2628, 2629, 2632, 2633, 2635, 2636, 2638 (incl Powerliner)	Rear	⊖ ⊖
CB0164	MERCEDES-BENZ	All	Actros, Atego, Axor 2628, 2629, 2632, 2633, 2636, 2641, 2644, 2646, 2650, 2651, 2654, 2655, 2658, 2932	Rear	⊖ ⊖
CB0171	RENAULT	All	Renault PREMIUM trucks	Rear	⊗ ⊖
CB0172	SCANIA		Scania P, G, R, T – series, 124 Cab Damper,	Front	⊥ T
CB0172	SCANIA	All	96, 114, 144 & 164 CAB DAMPER	Front	⊥ T
CB0175	VOLVO	All	FH (380, 400, 420, 440, 460, 480, 500, 520, 540)	Rear	⊖ ⊖
CB0176	SCANIA		Scania P, G, R, T – series	Front	⊥ T
CB0176	VOLVO	All	F6	Front	⊥ T
CB0186	DAF	All	DAF 95	Front	⊖ T
CB0186	DAF		DAF CF65, CF75, CF85 CAB DAMPER (with spring)	Front	⊖ T
CB0187	DAF		DAF CF65, CF75, CF85 CAB DAMPER (with spring)	Front	⊖ T
CB0195	SCANIA	All	Scania 94, 114, 124, 144 & 164 CAB DAMPER	Rear	⊥ ⊖
CB0197	MAN	All	TGA: 18., 19., 24., 26., 28., 32., 33., 35., 40., 41.	Rear	⊖ ⊖
CB0198	MAN	All	TGA: 18., 19., 24., 26., 28., 32., 33., 35., 40., 41.	Rear	⊖ ⊖
CB0199	ERF	All	ERF ECT 18..., 26...	Front	⊖ ⊖
CB0199	MAN	All	TGA: 18., 19., 24., 26., 28., 32., 33., 35., 40., 41.	Front	⊖ ⊖
CB0199	MAN	All	TGS: 18., 19., 24., 26., 28., 32., 33., 35., 40., 41.	Front	⊖ ⊖
CB0201	MAN	All	TGA: 18., 19., 24., 26., 28., 32., 33., 35., 40., 41.	Front	⊖ ⊖
CB0201	MAN	All	TGS: 18., 19., 24., 26., 28., 32., 33., 35., 40., 41.	Front	⊖ ⊖
CB0204	VOLVO	All	FH12, FH16 Cabin Damper	Rear	⊖ ⊖
CB0205	VOLVO	All	FH (380, 400, 420, 440, 460, 480, 500, 520, 540)	Front	⊥ ⊖
CB0207	VOLVO	All	FH (380, 400, 420, 440, 460, 480, 500, 520, 540)	Front	⊥ ⊖
CB0208	VOLVO	All	FH12, FH16 Cabin Damper	Rear	⊥ ⊖
CB0213	VOLVO	All	FH12, FH16 Cabin Damper	Rear	⊖ ⊖
CB0218	MERCEDES-BENZ	All	Actros, Atego, Axor : 2523, 2528, 2532, 2536, 2541, 2544, 2546, 2548, 2551, 2555, 2560	Rear	⊖ ⊖
CB0218	MERCEDES-BENZ	All	Actros, Atego, Axor 2628, 2629, 2632, 2633, 2636, 2641, 2644, 2646, 2650, 2651, 2654, 2655, 2658, 2932	Rear	⊖ ⊖
CB0220	MERCEDES-BENZ	All	Actros, Atego, Axor : 2223, 2224, 2225, 2226, 2228, 2229, 2232, 2233, 2235, 2236, 2238, 2244, 2426, 2428, 2429, 2432, 2435, 2436, 2438, 2448, 2531, 2534, 2535, 2538, 2540, 2543, 2544, 2548, 2550, 2553, 2623, 2626, 2628, 2629, 2632, 2633, 2635, 2636, 2638 (incl Powerliner)	Front	⊖ ⊖
CB0220	MERCEDES-BENZ	All	Atego, Actros & Axor 1823 -> 1857 Actros 1858, 1860	Front	⊖ ⊖
CB0220	MERCEDES-BENZ	All	Actros, Atego, Axor 2628, 2629, 2632, 2633, 2636, 2641, 2644, 2646, 2650, 2651, 2654, 2655, 2658, 2932	Front	⊖ ⊖
CB0220	MERCEDES-BENZ	All	Actros, Atego, Axor : 2523, 2528, 2532, 2536, 2541, 2544, 2546, 2548, 2551, 2555, 2560	Front	⊖ ⊖
CB0220	MERCEDES-BENZ	All	Atego 1923, 1924, Axor, Atego : 2523, 2528, 2529, 2533	Front	⊖ ⊖
CB0220	MERCEDES-BENZ	All	Atego 1513, 1517, 1518, 1519, 1522, 1523, 1524, 1526, 1528, 1529, 1621, Atego 1317, 1318, 1322, 1323, 1324, 1326, 1328, 1329	Front	⊖ ⊖
CB0220	MERCEDES-BENZ	All	Atego 1: 712, 714, 715, 717, 812, 814, 815, 817, 823, Atego 914, 917, 923, 1017, 1023	Front	⊖ ⊖
CB0220	MERCEDES-BENZ	All	2223, 2226, 2228, 2232, 2233, 2235, 2236, 2238 (incl Atego)	Front	⊖ ⊖
CB0235	DAF	All	DAF XF95, XF105	Front	⊖ T
CB0237	DAF	All	DAF XF95, XF105 (with spring)	Rear	⊖ T

Key

*	See important installation information on inside front cover
!	Excluding self-levelling suspension
...	Special order – phone 010 900 1850. 6-12 week waiting period

~	Imported
#	Internal bump stop
⊖	Steering damper

- It is recommended that all new shock absorbers are fitted in pairs
- Do not mix gas and non-gas units on the same axle
- **Bold** part numbers indicate heavy-duty shocks
- Underlined part numbers indicate parts not immediately available
- *Italic* part numbers followed by > indicate parts to be discontinued

Cab dampers

Part number [numerical listing]

Part number	Make	Year	Application	Position	Mounting information
SPECIAL ORDER					
"CB0003"	VOLVO	All	FH12, FH16 Cabin Damper	Front	⊖ ⊖
"CB0005"	VOLVO	All	FM7 Cabin Damper	Front	⊖ ⊖
"CB0005"	VOLVO	All	FM12 Cabin Damper	Front	⊖ ⊖
"CB0005"	VOLVO	All	FM10 Cabin Damper	Front	⊖ ⊖
"CB00276"	MERCEDES-BENZ	All	Actros 2031, 2040, 2053, 2531, 2535, 2540, 2543, 2548, 2631, 2635, 2640, 2643, 2648, 2653, 2657	Front	⊖ ⊖
"CB0028"	VOLVO	All	FH12, FH16 Cabin Damper	Front	⊖ ⊖
"CB0039"	VOLVO	All	FM9, FM12, FH12, FH16 Cabin Damper	Front	⊥ ⊖
"CB0042"	DAF	All	DAF XF95, XF105 (air)	Rear	⊖ ⊖
"CB0080"	MERCEDES-BENZ	All	Atego 914, 917, 923, 1017, 1023	Rear	⊖ ⊖
"CB0080"	MERCEDES-BENZ	All	800 series	Rear	⊖ ⊖
"CB0080"	MERCEDES-BENZ	All	1114, 1117, 1120, 1124	Rear	⊖ ⊖
"CB0091"	MAN	All	TGA: 18., 19., 24., 26., 28., 32., 33., 35., 40., 41.	Rear	⊖ ⊖
"CB0097"	MERCEDES-BENZ	All	2017, 2019, 2024, 2029, 2632, 2628, L, LB	Rear	⊖ ⊖
"CB0097"	MERCEDES-BENZ	All	Actros 2032, 2036, 2041, 2044, 2046, 2050, 2051	Rear	⊖ ⊖
"CB0097"	MERCEDES-BENZ	All	2640, 2643, 2644, 2648, 2653	Rear	⊖ ⊖
"CB0097"	MERCEDES-BENZ	All	2031, 2035, 2038, 2044, 2055	Rear	⊖ ⊖
"CB0097"	MERCEDES-BENZ	All	Atego, Actros & Axor 1823 -> 1857 Actros 1858, 1860	Rear	⊖ ⊖
"CB0097"	MERCEDES-BENZ	All	Actros, Axor: 3331, 3340, 3343, 3348, 3353	Rear	⊖ ⊖
"CB0097"	MERCEDES-BENZ	All	Actros 2031, 2040, 2053, 2531, 2535, 2540, 2543, 2548, 2631, 2635, 2640, 2643, 2648, 2653, 2657	Rear	⊖ ⊖
"CB0097"	MERCEDES-BENZ	All	Axor 1820, 1824	Rear	⊖ ⊖
"CB0097"	MERCEDES-BENZ	All	Actros 3231, 3232, 3241, 3246, 3248, 3332, 3336, 3341, 3344, 3346, 3350, 3351, 3354, 3355, 3357, 3360	Rear	⊖ ⊖
"CB0097"	MERCEDES-BENZ	All	Actros, Atego, Axor : 2523, 2528, 2532, 2536, 2541, 2544, 2546, 2548, 2551, 2555, 2560	Rear	⊖ ⊖
"CB0097"	MERCEDES-BENZ	All	3028, 3033, 3035, 3036, 3228, Axor 3228C, 3235, 3238, 3244, 3335, 3534, 3535	Rear	⊖ ⊖

Key

*	See important installation information on inside front cover
!	Excluding self-levelling suspension
"..."	Special order - phone 010 900 1850. 6-12 week waiting period

~	Imported
#	Internal bump stop
⊖	Steering damper

- It is recommended that all new shock absorbers are fitted in pairs
- Do not mix gas and non-gas units on the same axle
- **Bold** part numbers indicate heavy-duty shocks
- Underlined part numbers indicate parts not immediately available
- *Italic* part numbers followed by > indicate parts to be discontinued

Cab dampers

Part number [numerical listing]

Part number	Make	Year	Application	Position	Mounting information
SPECIAL ORDER					
"CB0097"	MERCEDES-BENZ	All	Actros, Atego, Axor 2628, 2629, 2632, 2633, 2636, 2641, 2644, 2646, 2650, 2651, 2654, 2655, 2658, 2932	Rear	⊖ ⊖
"CB0097"	MERCEDES-BENZ	All	1729S, 1732, 1735S, 1735 (IM Powerliner & Axor)	Rear	⊖ ⊖
"CB0144"	MERCEDES-BENZ	All	Atego, Actros & Axor 1823 -> 1857 Actros 1858, 1860	Rear	⊖ ⊗
"CB0173"	SCANIA	98-'04	Scania 4 Series	Rear	⊥ T
"CB0173"	SCANIA	All	Scania 94, 114, 124, 144 & 164 CAB DAMPER	Rear	⊥ T
"CB0212"	VOLVO	All	FM9, FM12 Cabin Damper	Front	⊥ ⊖
"CB0214"	VOLVO	All	FH12, FH16 Cabin Damper	Front	⊥ ⊖
"CB0263"	MERCEDES-BENZ	All	Actros 2031, 2040, 2053, 2531, 2535, 2540, 2543, 2548, 2631, 2635, 2640, 2643, 2648, 2653, 2657	Rear	⊖ ⊖
"CB0263"	MERCEDES-BENZ	All	Actros, Atego, Axor : 2523, 2528, 2532, 2536, 2541, 2544, 2546, 2548, 2551, 2555, 2560	Rear	⊖ ⊗
"CB0263"	MERCEDES-BENZ	All	Axor, Atego : 2523, 2528, 2529, 2533	Rear	⊖ ⊗
"CB0263"	MERCEDES-BENZ	All	Actros, Axor: 3331, 3340, 3343, 3348, 3353	Rear	⊖ ⊗
"CB0263"	MERCEDES-BENZ	All	Actros, Atego, Axor 2628, 2629, 2632, 2633, 2636, 2641, 2644, 2646, 2650, 2651, 2654, 2655, 2658, 2932	Rear	⊖ ⊗
"CB0263"	MERCEDES-BENZ	All	Atego, Actros & Axor 1823 -> 1857 Actros 1858, 1860	Rear	⊖ ⊗
"CB0263"	MERCEDES-BENZ	All	Actros 4140, 4144, 4148	Rear	⊖ ⊗
"CB0276"	MERCEDES-BENZ	All	Atego, Actros & Axor 1823 -> 1857 Actros 1858, 1860	Front	⊖ ⊖
"CB0276"	MERCEDES-BENZ	All	Actros, Atego, Axor : 2523, 2528, 2532, 2536, 2541, 2544, 2546, 2548, 2551, 2555, 2560	Front	⊖ ⊖
"CB0277"	MERCEDES-BENZ	All	Atego 914, 917, 923, 1017, 1023, Atego 1: 712, 714, 715, 717, 812, 814, 815, 817, 823	Rear	⊖ ⊗
"CB0277"	MERCEDES-BENZ	All	Atego 1513, 1517, 1518, 1519, 1522, 1523, 1524, 1526, 1528, 1529, 1621,	Rear	⊖ ⊗
"CB0278"	MERCEDES-BENZ	All	Atego 1513, 1517, 1518, 1519, 1522, 1523, 1524, 1526, 1528, 1529, 1621,	Rear	⊖ ⊗
"CB0278"	MERCEDES-BENZ	All	Atego 914, 917, 923, 1017, 1023	Rear	⊖ ⊗
"CB0278"	MERCEDES-BENZ	All	Atego, 1013, 1017, 1019, 1213, 1214, 1215, 1216, 1217, 2018, 1219, 1222, 1223, 1224, 1225, 1226, 1228, 1229, 1420, 1422, 1424	Rear	⊖ ⊗

Key

*	See important installation information on inside front cover
!	Excluding self-levelling suspension
"..."	Special order – phone 010 900 1850. 6-12 week waiting period

~	Imported
#	Internal bump stop
⊖	Steering damper

- It is recommended that all new shock absorbers are fitted in pairs
- Do not mix gas and non-gas units on the same axle
- **Bold** part numbers indicate heavy-duty shocks
- Underlined part numbers indicate parts not immediately available
- *Italic* part numbers followed by > indicate parts to be discontinued



SHOCK ABSORBER TESTER

IMPROVE CUSTOMER SAFETY
AND GROW YOUR BUSINESS

The quick, affordable and reliable
method to help identify when
shock absorbers are worn.



PART NO.	INCLUDED
MSTK1	Shock Tester Kit incl (tester, printer & poly bumps)



Scan the QR code to view the instructional video, or visit:
monroe.com.au/products/monroe-shock-absorber-tester



Maxlift

Part number [numerical listing]

Part number	Make	Year	Application	Position
ML0083	RENAULT	09-Nov 21	Kangoo II MPV	Tailgate
ML0083	RENAULT	09-Nov 21	Kangoo II minivan	Tailgate
ML0158 R ML0157 I	TOYOTA	05 – on	Quantum Van & Minibus ML Ses'fikile taxi (gen 5 Hi-Ace)	Tailgate
ML0166	VOLKSWAGEN	13-19	Golf VII (5G1)	Bonnet
ML0183	MERCEDES-BENZ	02-04	Vito Minibus & Van 113 FWD (638 Gen 1)	Tailgate
ML0185 >	MERCEDES-BENZ	02-04	Vito Minibus & Van 113 FWD (638 Gen 1)	Tailgate
ML0200 I ML0282 R	FORD	13-19	Kuga SUV (II)	Hatch
ML0202	AUDI	08-Jan 16	  A4 Sedan & Avant (B8)	Bonnet
ML0202	AUDI	08-Jan 16	A5 Coupe & Cabriolet (BT)	Bonnet
ML0208	VOLKSWAGEN	Aug'04 – 15	Type V Caravelle, Kombi, Transporter, Crew bus & Van T5 ML 4Motion 4WD (front engine)	Tailgate (Van)
ML0210	JEEP	March'11-on	Jeep Grand Cherokee All (WK2 series)	Tailgate
ML0215	VOLVO	95-April'00	S40 Sedan & V40 S/W ML Sport & T4	Bonnet
ML0215	VOLVO	April'00- May'04	S40 Sedan & V40 S/W ML Sport & T4	Bonnet
ML0223 > "ML5709"	KIA	99-04	Carnival MPV GQ (gen 1)	Tailgate
ML0230	VOLKSWAGEN	05 – 11	  Passat Sedan & S/Wagon (B6)	Bonnet
ML0230	VOLKSWAGEN	09-12	Passat CC ML AWD 4-Motion Syncro	Bonnet
ML0243	AUDI	May'12-20	A3 (8V) gen 3	Bonnet
ML0250	VOLKSWAGEN	92-99	Golf III & Jetta III	Bonnet
ML0250	VOLKSWAGEN	04-Feb'09	Golf V (1K1)	Bonnet
ML0250	VOLKSWAGEN	March'06-Sept'11	Jetta V (1K2)	Bonnet
ML0259 > ML5726	VOLVO	06-14	 C70 Cabriolet	Bonnet
ML0259 > ML5726	VOLVO	June'04-12	S40 Sedan & V50 S/W ML T5 (Gen 2)	Bonnet
ML0260	KIA	End 14-19	Soul hatch (PS)	Bonnet
ML0265	AUDI	95- Jan'99	 A4 Sedan 8D, B5	Bonnet
ML0265	AUDI	96- Jan'99	 A4 Avant 8D, B5	Bonnet
ML0265	AUDI	Feb'99-Nov'00	 A4 Sedan (ML Avant S/W) B5, 8D	Bonnet
ML0265	AUDI	Feb'99-Nov'00	 A4 Avant (ML Sedan) B5, 8D	Bonnet
ML0268	VOLKSWAGEN	11-15	Passat sedan (B7)	Bonnet
ML0271	VOLKSWAGEN	March'09-13	Golf VI (5K1)	Bonnet
ML0279	HONDA	17-23	CR-V 4x4 gen 5 (RW)	Tailgate
ML0283	AUDI	15 – on	Q7 4x4 (4M)	Bonnet
ML0289	AUDI	Dec'00- 04	 +  A4 Sedan & Avant B6. 8E	Bonnet
ML0289	AUDI	05-07	 (S/W) A4 & Avant (ML Cabriolet boot) B7	Bonnet
ML0299	AUDI	97-Jan'99	A6 Sedan & Avant	Bonnet
ML0299	AUDI	Feb'99-April'00	A6 Sedan & Avant	Bonnet
ML0299	AUDI	May'00-March'04	A6 Sedan & Avant	Bonnet
ML0299	VOLKSWAGEN	99-05	 Passat Sedan (B5)	Bonnet
ML0303	VOLKSWAGEN	04-May 15	Caddy All (2KA) gen 3	Hatch
ML0303	VOLKSWAGEN	June 15-Oct 21	Caddy All (2KA, SA) gen 3 facelift	Hatch
ML0326	AUDI	May'03-12	A3 (8P1) gen 2	Bonnet
ML0326	AUDI	08-13	A3 Cabriolet	Bonnet
ML0360 R > ML0361 I >	TOYOTA	Mid 00- 05	Condor 4x2 & 4x4	Tailgate
ML0367	VOLVO	Nov'12-on	V40 Hatch ML T5 & Cross Country (Gen 3)	Bonnet
ML0407 R ML0408 I	TOYOTA	69-10	Hi-Ace Minibus, Taxi & Panel van	Tailgate
ML0422	RENAULT	June'04-08	Kangoo I Multix MPV people carrier (580kg payload)	Tailgate

Key

- * See important installation information on inside front cover
- ! Excluding self-leveling suspension
- "..." Special order – phone 010 900 1850. 6-12 week waiting period

- ~ Imported
- # Internal bump stop
- ⊕ Steering damper

- It is recommended that all new shock absorbers are fitted in pairs
- Do not mix gas and non-gas units on the same axle
- **Bold** part numbers indicate heavy-duty shocks
- Underlined part numbers indicate parts not immediately available
- *Italic* part numbers followed by > indicate parts to be discontinued

Maxlift

Part number [numerical listing]

Part number	Make	Year	Application	Position
ML0422	RENAULT	01-09	Kangoo I Express minivan (750kg payload)	Tailgate
ML0428	VOLKSWAGEN	Aug'04 – 15	Type V Caravelle, Kombi, Transporter, Crew bus & Van T5 ML 4Motion 4WD (front engine)	Tailgate (Power)
ML0450 >	VOLKSWAGEN	99-Oct'12	New Beetle (Type 2) EXC cabriolet & EXC models with spoiler	Bonnet
ML0455	VOLKSWAGEN	90- July'04	Type IV Caravelle T4 ML 2.5 Tdi, Transporter & Syncro 4WD (front engine)	Tailgate
ML0505 >	CHRYSLER	95-00	Voyager 2.0 SWB & Grand Voyager 3.3 V6 & 2.5 TD LWB	Tailgate
ML0506	VOLKSWAGEN	Oct'12-17	New Beetle (Type 2)	Hatch (with spoiler)
ML0510	MERCEDES-BENZ	15-24	V Class 7 seater MPV (W447)	Tailgate
ML0510	MERCEDES-BENZ	Oct '15 – 24	Vito Van 111 (1.6 FWD), 114, 116, 119 (2.2 RWD) (W447 Gen 3)	Tailgate
ML0511	MERCEDES-BENZ	15-24	V Class 7 seater MPV (W447)	Tailgate
ML0511	MERCEDES-BENZ	Oct '15 – 24	Vito Van 111 (1.6 FWD), 114, 116, 119 (2.2 RWD) (W447 Gen 3)	Tailgate
ML0512	MERCEDES-BENZ	15-24	V Class 7 seater MPV (W447)	Tailgate
ML0512	MERCEDES-BENZ	Oct '15 – 24	Vito Van 111 (1.6 FWD), 114, 116, 119 (2.2 RWD) (W447 Gen 3)	Tailgate
ML0519	MERCEDES-BENZ	Mid 04 -July'11	SLK (R171)	Bonnet
ML0525	MERCEDES-BENZ	06-July'11	CLS350 & CLS500 (W219)	Bonnet
ML0525	MERCEDES-BENZ	Aug'11-18	CLS250 CLS350, CLS500 (W218)	Bonnet
ML0525	MERCEDES-BENZ	Aug'02-09	W211 E Class sedan	Bonnet
ML0525	MERCEDES-BENZ	Aug'02-mid 09	W211 E Class S/Wagon	Bonnet
ML0539	VOLKSWAGEN	Oct 16-23	Tiguan SUV gen 2 (AD/BW)	Bonnet
ML0552	MERCEDES-BENZ	14-19	GLA SUV (X156)	Tailgate Manual
ML0597	AUDI	92-'01	80 / 100 / 500 Cabriolet	Bonnet
ML0597	AUDI	95- Jan'99	 A4 Sedan 8D, B5	Bonnet
ML0597	AUDI	96- Jan'99	 A4 Avant 8D, B5	Bonnet
ML0597	AUDI	Feb'99-Nov'00	 A4 Sedan EXC Avant S/W B5, 8D	Bonnet
ML0597	AUDI	Feb'99-Nov'00	 A4 Avant EXC Sedan B5, 8D	Bonnet
ML0602	MERCEDES-BENZ	06-Sept 14	Viano 7 seater MPV (W639)	Tailgate
ML0602	MERCEDES-BENZ	04-Aug 15	Vito Minibus & Van RWD (W639 Gen 2)	Tailgate
ML0605 R > ML0609 L >	MAZDA	83-93	Mazda 626	Hatch
ML0605 R > ML0609 L >	MAZDA	81-03	Mazda 323 ML Sting (gen 5 & 6)	Hatch
ML0608	RENAULT	09-Aug 16	Megane III Hatch	Bonnet
ML0608	RENAULT	09-Aug 16	Megane III cc Coupe and Cabriolet	Bonnet
ML0635 >	JEEP	07-09	Commander 3.0, 4.7 & 5.6 (XK)	Tailgate
ML0638 L ML0639 R	MERCEDES-BENZ	May'07-May 14	W204 C Class sedan	Bonnet
ML0638 L ML0639 R	MERCEDES-BENZ	May'07-May 14	W204 C Class S/Wagon	Bonnet
ML0662	VOLKSWAGEN	11-18	Touareg 4x4 (7P)	Bonnet
ML0665	JEEP	97-06	Jeep Wrangler 4x4 (TJ series) ML Sport EXC Rubicon	Rear Glass
ML0674	MERCEDES-BENZ	Mid 09-16	W212 E Class sedan	Bonnet
ML0674	MERCEDES-BENZ	Mid 09-16	W212 E Class S/Wagon	Bonnet
ML0674	MERCEDES-BENZ	Mid 09-16	E Class C207 Coupe / A207 Cabriolet	Bonnet
ML0682	HONDA	06-Aug 16	 CivicHatch Mk8 (FN, FK)	Hatch (3 Door)
ML0683	MERCEDES-BENZ	98-05	ML SUV (W163)	Tailgate
ML0686	BMW	11-17	X3 SUV	Tailgate Manual
ML0687	KIA	04 – April'07	Sedona MPV gen 1 (GQ)	Tailgate
ML0709	TOYOTA	84-88	Conquest ML Twin Cam (F.W.D)	Hatch
ML0744 R ML0743 L	TOYOTA	05 – on	Quantum Van & Minibus ML Ses'fikile taxi (gen 5 Hi-Ace)	Tailgate
ML0767	LAND ROVER	12-May19	Evoque SUV (L538)	Tailgate

Key

*	See important installation information on inside front cover
!	Excluding self-levelling suspension
"..."	Special order – phone 010 900 1850. 6-12 week waiting period

~	Imported
#	Internal bump stop
⊕	Steering damper

- It is recommended that all new shock absorbers are fitted in pairs
- Do not mix gas and non-gas units on the same axle
- **Bold** part numbers indicate heavy-duty shocks
- Underlined part numbers indicate parts not immediately available
- *Italic* part numbers followed by > indicate parts to be discontinued

Maxlift

Part number [numerical listing]

Part number	Make	Year	Application	Position
ML0778 > ML0779 > ML1451	TOYOTA	98-06	Conquest Carri Panel Van	Hatch
ML0778 > ML0779 > ML1451	TOYOTA	89-96	Conquest Twin Cam & 1800 (F.W.D) P140 (EE90, AE92, CE90)	Hatch
ML0778 > ML0779 > ML1451	TOYOTA	96-June'06	Conquest / Tazz (EE90, AE92)	Hatch
ML0795	BMW	Nov'01-05	All 3 Series Compact (E46) sedan	Tailgate
ML0813 ML0817	HONDA	96- March'01	Ballade & Civic Vtec) (EJ9, EK1, EK3, EK4) Mk6	Tailgate
ML0815	MERCEDES-BENZ	15-19	GLE SUV (W166) + Coupe (C292)	Tailgate
ML0815	MERCEDES-BENZ	June'12-15	ML SUV (W166)	Tailgate
ML0819	VOLKSWAGEN	Oct 16-23	Tiguan SUV gen 2 (AD / BW)	Tailgate (Manual)
ML0830	HONDA	07-12	CR-V 4x4 gen 3 (RE)	Tailgate
ML0855	BMW	04-10	X3 SUV	Tailgate
ML0861 > "ML5432"	PEUGEOT	98-02	306 S/Wagon cc)	Tailgate S/W
ML0890	OPEL	15-April 22	Mokka (J13)	Tailgate
ML0892 ML0896	MERCEDES-BENZ	15-19	GLE SUV (W166) + Coupe (C292)	Bonnet
ML0892 ML0896	MERCEDES-BENZ	13-19	GL & GLS SUV 4X4 (X166)	Bonnet
ML0892 ML0896	MERCEDES-BENZ	June'12-15	ML SUV (W166)	Bonnet
ML0953 ML0954	MAZDA	Oct'14-June 19	Mazda 3 (BM)	Hatch
ML0996	OPEL	Nov'15-19	Corsa Hatch (E)	Hatch
ML1015 > ML5807	OPEL	Nov'07-Oct 15	Corsa Hatch Lite) (D)	Hatch
ML1063	VOLVO	95-April'00	S40 Sedan & V40 S/W Sport & T4	Tailgate S/W
ML1069	JEEP	91-01	Jeep Cherokee 4x4 Sport, Limited & Country (XJ)	Tailgate
ML1115	HONDA	13-16	CR-V 4x4 gen 4 (RM)	Tailgate
ML1133 > "ML5323"	PEUGEOT	98-01	306 Hatch cc)	Hatch
ML1134	VOLKSWAGEN	99-Oct'12	New Beetle (Type 2) cabriolet & models with spoiler	Hatch
ML1134	VOLKSWAGEN	99-04 (Jetta till 2/06)	Golf IV & Jetta IV Estate S/W)	Hatch (Gti)
ML1135	FORD	Aug'11-18	Focus Hatch & Sedan MkIII	Hatch
ML1147	HYUNDAI	09-21	H-1 Minibus 9 seater / Van	Hatch
ML1233	RENAULT	96-Feb'04	Scenic MPV	Tailgate
ML1233	RENAULT	01-04	Scenic RX4 4x4	Tailgate
ML1250	OPEL	93-Oct'99	Kadett & Astra S/W) (model F)	Hatch
ML1296	VOLKSWAGEN	11-18	Touareg 4x4 (7P)	Tailgate
ML1297 > "ML5127"	VOLKSWAGEN	98-07	Sharan MPV	Tailgate
ML1316	RENAULT	13-Sept 18	Duster SUV gen 1	Bonnet
ML1320 > "ML6122"	OPEL	end 10-May 16	Astra (model J)	Hatch
ML1340	RENAULT	08-13	Koleos 4x4 SUV (HY)	Tailgate
ML1361 >	FIAT	00-02	Palio Weekend S/Wagon Type PY & 1Y	Tailgate
ML1361 >	FIAT	02-10	Palio II Weekend S/Wagon Type 2G & 2K	Tailgate
ML1376	JEEP	07-11	Jeep Wrangler 4x4 (JK series) 2 & 4 door Rubicon & Unlimited	Rear Glass
ML1393 >	CHRYSLER	01-10	PT Cruiser cabriolet)	Tailgate
ML1396 >	FORD	05-09	Territory 4x2 & 4x4 SUV (SX, SY & SY1)	Tailgate
ML1398	CHEVROLET	07-March'11	Captiva SUV (C100)	Tailgate
ML1398	CHEVROLET	April'11-18	Captiva SUV (T300)	Tailgate

Key

	See important installation information on inside front cover
	Excluding self-leveling suspension
	Special order - phone 010 900 1850. 6-12 week waiting period

	Imported
	Internal bump stop
	Steering damper

- It is recommended that all new shock absorbers are fitted in pairs
- Do not mix gas and non-gas units on the same axle
- **Bold** part numbers indicate heavy-duty shocks
- Underlined part numbers indicate parts not immediately available
- *Italic* part numbers followed by > indicate parts to be discontinued

Maxlift

Part number [numerical listing]

Part number	Make	Year	Application	Position
ML1404 >	RENAULT	13-20	Sandero hatch	Bonnet
ML1413	FORD	97-03	Fiesta Mk4 facelift (JA, JB)	Hatch
ML1413	MAZDA	97-99	121 Soho	Hatch
ML1413	MAZDA	99-06	121 Soho	Hatch
ML1418 > "ML5469"	PEUGEOT	02-12	206 S/Wagon	Tailgate
ML1419	MINI	01-02	Mini One, Cooper, Cooper S, One D (R50 Mk I)	Bonnet
ML1419	MINI	02-06	Mini One, Cooper, Cooper S, One D (R50, R52, R53 Mk I)	Bonnet
ML1426	NISSAN	April'08-Aug 14	X-Trail 4x2 and 4x4 All (T31, T31R)	Tailgate
ML1431 ML1432	MERCEDES-BENZ	06-May'12	ML SUV (W164)	Bonnet
ML1451	TOYOTA	96-June'06	Tazz	Hatch
ML1454	HYUNDAI	16-22	Tucson (TL)	Tailgate (Manual)
ML1485 >	FORD	Mid 81-86	Escort FWD	Tailgate
ML1500	VOLVO	Nov'12-on	V40 Hatch T5 & Cross Country (Gen 3)	Hatch
ML1514	OPEL	01-Sept'04	(S/W) Astra Caravan S/Wagon (model G)	Tailgate S/W
ML1533	VOLKSWAGEN	90- July'04	Type IV Caravelle T4 2.5 Tdi, Transporter & Syncro 4WD (front engine)	Tailgate
ML1551	BMW	10-Oct 15	X1 SUV gen 1	Tailgate
ML1567	KIA	Nov'04-Sept'10	Sportage 4x4 & 4x2 Gen 2 (JE)	Tailgate
ML1587	HYUNDAI	09-June'12	i30 Hatch gen1 (FD)	Hatch
ML1625	FIAT	90-'06	Uno All	Tailgate
ML1625	FIAT	07-09	Uno (raised body "Way" version)	Tailgate
ML1643	TOYOTA	Oct'15-21	Aygo hatch gen 2 (AB40)	Hatch
ML1653	OPEL	96-02	Corsa Hatch Corsa LITE & Lite Sport (B)	Hatch (5 door)
ML1653	OPEL	02-15	Corsa LITE & Lite Sport – old shape Corsa (B)	Hatch (5 door)
ML1670	VOLKSWAGEN	08-'09	Tiguan gen 1 (5N)	Tailgate
ML1674	HONDA	Sept 16 – on	Civic Hatch Mk8 (FC, FK)	Tailgate
ML1675	PEUGEOT	Sept'02-10	(S/W) 307 S/Wagon (cc)	Tailgate S/W
ML1681	JEEP	91- 01	Jeep Cherokee 4x4 Sport, Limited & Country (XJ)	Tailgate
ML1703	MERCEDES-BENZ	06-May'12	ML SUV (W164)	Tailgate
ML1711 > "ML5381"	HYUNDAI	01-06	Sante Fe 4X4 Gen 1 (SM)	Tailgate
ML1712	VOLVO	11-18	V60 S/Wagon Cross Country	Tailgate
ML1714	VOLVO	09-Sept 18	XC60 AWD SUV	Tailgate (manual)
ML1727	HONDA	02-06	CR-V 4x4 2.0, 2.2 gen 2 (RD)	Tailgate
ML1735	CITROEN	08-14	C1	Hatch
ML1762 > ML1763 >	SUBARU	June'02-08	Forester AWD (SG)	Tailgate
ML1779	JEEP	08-'13	Jeep Cherokee 4x4 (KK)	Tailgate
ML1780 >	KIA	May'14-on	Sedona MPV gen 3 (YP)	Tailgate
ML1783 ML1784	MAZDA	Mid 09-Sept'14	Mazda 3 (BL)	Hatch
ML1799	AUDI	15 – on	Q7 4x4 (4M)	Tailgate
ML1874	VOLVO	10-18	S60 Sedan gen 2	Boot
ML1881	OPEL	Mid 85-88	Kadett & Monza Sedan (F.W.D) "T car" (model E)	Hatch
ML1881	OPEL	89-92	Kadett & Monza Sedan (F.W.D) "T car" (model E)	Hatch
ML1890	KIA	03-Oct 09	Sorento 4x4 & 4x2 (JC)	Tailgate
ML1893	KIA	April 16-Sept '22	Sportage 4x4 & 4x2 2.0, 2.4 Gen 4 (QL)	Tailgate
ML1896	VOLKSWAGEN	Feb 18-on	Polo Hatch & Sedan Vivo, CrossPolo (mk 6 model AW)	Hatch
ML1903 > ML1904 >	SUBARU	08-13	Forester AWD (SH)	Tailgate

Key

*	See important installation information on inside front cover
!	Excluding self-levelling suspension
"..."	Special order – phone 010 900 1850. 6-12 week waiting period

~	Imported
#	Internal bump stop
⊕	Steering damper

- It is recommended that all new shock absorbers are fitted in pairs
- Do not mix gas and non-gas units on the same axle
- **Bold** part numbers indicate heavy-duty shocks
- Underlined part numbers indicate parts not immediately available
- *Italic* part numbers followed by > indicate parts to be discontinued

Maxlift

Part number [numerical listing]

Part number	Make	Year	Application	Position
ML1918	MINI	14-24	Mini One, Cooper, Cooper D, Cooper S, One D (F55, F56 Mk III) cabriolet	Hatch
ML1920	CITROEN	05-10	C4 1.6i, 2.0i gen 1	Tailgate
ML1923	OPEL	01-05	Zafira 1.6, 1.8, 1.9CDTi, 2.2 MPV (A)	Tailgate
ML1927	MERCEDES-BENZ	15-24	V Class 7 seater MPV (W447)	Glass
ML1927	MERCEDES-BENZ	Oct '15 - 24	Vito Van 111 (1.6 FWD), 114, 116, 119 (2.2 RWD) (W447 Gen 3)	Glass
ML1941	OPEL	96-02	Corsa Hatch (B)	Hatch (3 door)
ML1941	OPEL	02-15	Corsa LITE & Lite Sport – old shape Corsa (B)	Hatch (3 door)
ML1958	OPEL	Sept'04-09	Astra (model H)	Bonnet
ML1959	MERCEDES-BENZ	06-March'12	B170, B200T, B200CDi (W245)	Hatch
ML1960	AUDI	May'12-20	A3 (8V) gen 3	Hatch
ML1974	KIA	March 15-on	Sorento 4x4 & 4x2 (UM)	Tailgate
ML1980	MERCEDES-BENZ	00-04	A160, A170CDi A190 (W168)	Hatch
ML1989	HONDA	Jan'98 - 02	CR-V 4x4 2.0 gen 1 (RD 1)	Tailgate
ML1992	LAND ROVER	99- end 04	Discovery 2	Tailgate
ML2003	VOLKSWAGEN	04-10	Touareg 4x4 (7L)	Bonnet
ML2011 >	HYUNDAI	06-early July'11	Accent III Sedan & Hatch (MC)	Hatch
ML2017 >	HYUNDAI	94- May'97	Accent I sedan (X3)	Hatch
ML2017 >	HYUNDAI	June'97-June'00	Accent I sedan (X3) facelift	Hatch
ML2018	MAZDA	04-09	Mazda 3 (BK)	Hatch
ML2029	OPEL	Nov'99-Sept'04	Astra hatch (model G) S/W	Hatch
ML2029 >	FORD	95-99	Escort FWD estate S/W	Tailgate
ML2032 ML2034	MERCEDES-BENZ	Sept'00-April'07	W203 C Class sedan	Bonnet
ML2032 ML2034	MERCEDES-BENZ	Sept'00-April'07	W203 C Class S/Wagon	Bonnet
ML2032 ML2034	MERCEDES-BENZ	00-11	CLC203 C Class coupe	Bonnet
ML2041 > ML2045 >	MAZDA	94- 99	Etude BH / Astina BA – J55 (RSA Mnf)	Hatch:
ML2048	VOLKSWAGEN	13-19	Golf VII (5G1)	Hatch
ML2055	AUDI	May'03-12	A3 (8P1) gen 2	Hatch
ML2059	TOYOTA	04-Oct'09	Corolla Verso MPV	Tailgate
ML2059	TOYOTA	Nov'09-12	Corolla Verso MPV	Tailgate
ML2060	RENAULT	end 09-16	Scenic & Grand Scenic III MPV 1.6, 1.9dCi	Tailgate
ML2066	MITSUBISHI	end 12-April 23	Outlander SUV (Gen 3)	Tailgate
ML2075	BMW	01-06	X5	Tailgate
ML2078	VOLKSWAGEN	Feb'10-Jan 18	Polo Hatch & Sedan Vivo, CrossPolo (mk 5 model 6R)	Hatch
ML2078	VOLKSWAGEN	March 18-on	Polo VIVO Hatch (mk 5, 6R)	Hatch
ML2084	NISSAN	July'14-on	Qashqai SUV (J11)	Tailgate
ML2094 ML2095	TOYOTA	March'06-March 16	Fortuner SUV 3.0TD & 4.0 V6 4x4 and 4x2 High Rider	Tailgate
ML2106	TOYOTA	Nov'09-on	Prado J150 elec susp) 3.0 GRJ150, 4.0 KDJ150	Bonnet
ML2110	JEEP	07-16	Compass (MK) facelift	Tailgate
ML2111	NISSAN	02-March'08	X-Trail 4x2 and 4x4 All (T30, T30II)	Tailgate
ML2125	VOLKSWAGEN	98-Sept'02	Polo Classic Sedan & Playa Hatch (mk 3) sport susp	Hatch
ML2147	RENAULT	09-13	Sandero hatch Stepway) (B90)	Hatch
ML2163 > "ML6316"	NISSAN	05-end 08	Murano 3.5 V6 4x4 SUV (Gen 1)	Tailgate
ML2173	PEUGEOT	00-12	206 Hatch	Hatch
ML2182 ML2183	HYUNDAI	00-08	Atos Prime earlier Atos)	Hatch
ML2186	RENAULT	March'04-end 09	Scenic II and Grand Scenic II (LWB)	Tailgate

Key

*	See important installation information on inside front cover
!	Excluding self-leveling suspension
"..."	Special order – phone 010 900 1850. 6-12 week waiting period

~	Imported
#	Internal bump stop
⊕	Steering damper

- It is recommended that all new shock absorbers are fitted in pairs
- Do not mix gas and non-gas units on the same axle
- **Bold** part numbers indicate heavy-duty shocks
- Underlined part numbers indicate parts not immediately available
- *Italic* part numbers followed by > indicate parts to be discontinued

Maxlift
Part number [numerical listing]

Part number	Make	Year	Application	Position
ML2192	MERCEDES-BENZ	12-Aug 18	A180, A200 (W176)	Hatch
ML2198	RENAULT	March'04-end 09	Scenic II and Grand Scenic II (LWB)	Tailgate
ML2209	VOLKSWAGEN	80-'03	Kombi, Panelvan, Microbus, Caravelle & Transporter Type III (EXC Front engined T4)	Tailgate
ML2220	VOLKSWAGEN	09-Sept 16	Tiguan gen 1 (5N)	Tailgate
ML2224	NISSAN	11-June 18	Micra (K13) gen 4	Hatch
ML2230	HYUNDAI	04 - 10	Tucson (JM)	Tailgate
ML2231	HONDA	96- March'01	Ballade & Civic (EXC Vtec) (EJ9, EK1, EK3, EK4) Mk6	Tailgate
ML2243	NISSAN	07-June 14	Qashqai SUV (J10) EXC +2 (7 seater)	Tailgate
ML2246	TOYOTA	11-Sept 15	Aygo hatch gen 1 (AB10)	Hatch
ML2263	VOLVO	02-July 15	XC90 AWD SUV gen 1	Bonnet
ML2266	HYUNDAI	July 12-16	i30 Hatch gen 2 (GD)	Hatch
ML2272 R > ML2271 L >	TOYOTA	98-07	Landcruiser 100 Series S/Wagon IFS, EXC Lexus IFS & Torsion Bars	Tailgate
ML2288	OPEL	July 05-10	Zafira 1.6, 1.8, 1.9CDTi MPV (Exc OPC, Sport & Panoramic) (B)	Tailgate
ML2309	SUZUKI	11-Aug 18	Swift hatch (gen 4) ZC72S, ZC82S	Tailgate
ML2318 L ML2319 R	TOYOTA	06-Dec 11	Avanza MPV & Panel Van	Tailgate
ML2318 L ML2319 R	TOYOTA	Jan 12-21	Avanza MPV & Panel Van	Tailgate
ML2318 L ML2319 R	TOYOTA	11 - 15	Innova 2.7 MPV	Tailgate
ML2337	OPEL	93-Oct'99	(S/W) Astra Estate S/Wagon (model F)	Tailgate S/W
ML2349 > "ML5377"	FIAT	03-10	Multipla MPV 1.6, 1.9JTD (EXC Bi-power)	Tailgate
ML2352	MAZDA	07-15	Mazda 2 (DE)	Hatch
ML2358 > "ML5743"	VOLKSWAGEN	04-10	Touran MPV gen 1 (1T)	Tailgate
ML2359	PEUGEOT	06-12	207 Hatch (EXC S/W)	Hatch
ML2364	JEEP	June'05 - Feb'11	Jeep Grand Cherokee All (WK series) (EXC up country / raised susp)	Tailgate
ML2368	MINI	11-16	Mini Countryman EXC AWD (R60)	Hatch
ML2372	TOYOTA	March'06 - 12	RAV4 (XA30) gen 3	Tailgate
ML2378	HONDA	March'01-05	 Civic Vtec 5 door hatch (EP, EU) Mk7	Tailgate
ML2378	HONDA	06-Aug 16	 CivicHatch Mk8 (FN, FK)	Hatch (5 door)
ML2386	AUDI	08-Jan 16	  A4 Sedan & Avant (B8)	Tailgate
ML2390	CITROEN	10-16	C4 1.6i, 2.0i gen 2	Tailgate
ML2411	NISSAN	07-June 14	Qashqai SUV (J10) EXC +2 (7 seater)	Tailgate
ML2417	AUDI	Dec'00- 04	 +  A4 Sedan & Avant B6, 8E	Tailgate
ML2423	FORD	13-on	Ecosport SUV	Rear Door
ML2460	RENAULT	Sept 16-22	Megane IV Hatch	Hatch
ML2467	AUDI	06 - 15	Q7 4x4 (4L)	Power Tailgate
ML2469	VOLKSWAGEN	92-99	Golf III & Jetta III	Hatch
ML2475 > ML2473	VOLKSWAGEN	85- 93	Golf II & Jetta II	Hatch
ML2477	PEUGEOT	74-85	504 estate S/Wagon	Hatch
ML2477	VOLKSWAGEN	78-10	Golf I / Jetta I & Citi	Hatch
ML2479	NISSAN	04-10	Micra (K12E) gen3	Hatch
ML2485	AUDI	98-April'03	A3 (8L1) gen 1	Bonnet
ML2485	VOLKSWAGEN	99-04 (Jetta till 2/06)	Golf IV & Jetta IV (EXC Estate S/W)	Bonnet
ML2485	VOLKSWAGEN	93-'04	Golf III & IV Cabriolet (EXC 16" wheels)	Bonnet
ML2489	VOLKSWAGEN	99-04 (Jetta till 2/06)	Golf IV & Jetta IV (EXC Estate S/W)	Hatch
ML2495	VOLKSWAGEN	Oct'02-Jan'10	Polo Classic Sedan and Hatch EXC CrossPolo (mk 4 9N3)	Hatch
ML2495	VOLKSWAGEN	Feb'10-Feb 18	Polo VIVO Hatch (mk 4, 9N3)	Hatch

Key

*	See important installation information on inside front cover
!	Excluding self-levelling suspension
"..."	Special order - phone 010 900 1850, 6-12 week waiting period

~	Imported
#	Internal bump stop
⊕	Steering damper

- It is recommended that all new shock absorbers are fitted in pairs
- Do not mix gas and non-gas units on the same axle
- **Bold** part numbers indicate heavy-duty shocks
- Underlined part numbers indicate parts not immediately available
- *Italic* part numbers followed by > indicate parts to be discontinued

Maxlift

Part number [numerical listing]

Part number	Make	Year	Application	Position
ML2519	JEEP	12-18	Jeep Wrangler (JK series)	Rear Glass
ML2532	KIA	Nov 09-Feb 15	Sorento 4x4 & 4x2 (XM)	Tailgate
ML2535	AUDI	98-April'03	A3 (8L1) gen 1	Tailgate
ML2577	AUDI	98-April'03	A3 (8L1) gen 1	Tailgate
ML2590	AUDI	08-Jan 16	A4 Sedan & Avant (B8)	Power Tailgate
ML2611	MINI	14-24	Mini One, Cooper, Cooper D, Cooper S, One D (F55, F56 Mk II) cabriolet	Hatch
ML2620	SUZUKI	15-on	Vitara gen 4 (LY)	Tailgate
ML2622	AUDI	08 - 17	Q5 4x4 (8R)	Power Tailgate
ML2624	AUDI	08 - 17	Q5 4x4 (8R)	Manual Tailgate
ML2636	MINI	01-02	Mini One, Cooper, Cooper S, One D (R50 Mk I)	Hatch
ML2636	MINI	02-06	Mini One, Cooper, Cooper S, One D (R50, R52, R53 Mk I)	Hatch
ML2636	MINI	07-13	Mini One, Cooper, Cooper D, Cooper S, One D (R56, R57 Mk II) cabriolet	Hatch
ML2636	MINI	08-14	Mini Clubman S/Wagon (R55)	Tailgate
ML2656	KIA	End 14-19	Soul hatch (PS)	Hatch
ML2660	JEEP	15-on	Renegade SUV (BU)	Tailgate
ML2670	MERCEDES-BENZ	05-12	A170, A180CDi, A200 (W169)	Hatch
ML2679	AUDI	May'03-12	A3 (8P1) gen 2	Hatch
ML2681	CHEVROLET	03-05	Spark (M100, M150)	Hatch
ML2681	DAEWOO	99-03	Matiz hatch M100	Hatch
ML2687 > ML2690 >	FORD	93-99	Telstar sedan and TX5 notchback	Hatch & Boot
ML2687 > ML2690 >	MAZDA	93-99	Mazda 626 MX6	Hatch
ML2694	CHEVROLET	April'11-18	Captiva SUV (T300)	Tailgate
ML2695 > ML2696 >	MAZDA	99-04	Mazda 5 Premacy MPV gen 1 (Cross border)	Tailgate
ML2707	MITSUBISHI	03 -May'07	Outlander SUV (Gen 1) CU2W, CU5W	Tailgate
ML2710	MITSUBISHI	June'07-end'12	Outlander SUV (Gen 2, GS platform) CW5W	Tailgate
ML2711 > (05-'08)	NISSAN	05-15	Pathfinder 2.5 Dci, 4.0 4x4 SUV (R51)	Tailgate
ML2718 >	NISSAN	05-15	Pathfinder 2.5 Dci, 4.0 4x4 SUV (R51)	Tailgate ('09-15)
ML2722	VOLKSWAGEN	Oct'11-19	Jetta VI (5C6)	Boot
ML2725 >	CHEVROLET	82-85	Ascona	Boot
ML2725 >	FORD	Mid 83-93	Sierra & Sapphire Sedan XR8 S/W	Tailgate & Boot
ML2726	FORD	Aug'11-18	Focus Hatch & Sedan MkIII	Boot ('11-'14)
ML2726	FORD	Aug'11-18	Focus Hatch & Sedan MkIII	Boot ('15-18)
ML2732	HYUNDAI	10-March 16	iX35 All (LM)	Tailgate
ML2737	KIA	March'06-Oct'11	Rio gen 2 (JB)	Hatch
ML2764	KIA	Nov'11-May 17	Rio gen 3 (UB)	Hatch
ML2771	AUDI	06 - 15	Q7 4x4 (4L)	Bonnet
ML2775	HYUNDAI	03-11	Getz (TB)	Hatch
ML2776 >	SUZUKI	05-20	Grand Vitara 4x4 (gen 2) JT, JB	Tailgate
ML2778	CHEVROLET	11-on	Aveo (gen two)	Tailgate
ML2778	CHEVROLET	11-on	Sonic hatch T300	Hatch
ML2807	FORD	Nov'04-July'11	Focus Hatch & Sedan MkII	Hatch
ML2814	VOLVO	07-13	C30 Hatch	Hatch
ML2822	AUDI	08-Jan 16	A5 Coupe & Cabriolet (BT)	Tailgate
ML2841	FIAT	00-03	Palio hatch Type 1X MkI	Tailgate
ML2841	FIAT	03-10	Palio II hatch Type 2H MkIV	Tailgate
ML2841	FIAT	01-10	Palio Expresso panel Van	Tailgate

Key

	See important installation information on inside front cover
	Excluding self-leveling suspension
	Special order - phone 010 900 1850. 6-12 week waiting period

	Imported
	Internal bump stop
	Steering damper

- It is recommended that all new shock absorbers are fitted in pairs
- Do not mix gas and non-gas units on the same axle
- **Bold** part numbers indicate heavy-duty shocks
- Underlined part numbers indicate parts not immediately available
- *Italic* part numbers followed by > indicate parts to be discontinued



Maxlift

Part number [numerical listing]

Part number	Make	Year	Application	Position
ML2862	RENAULT	13-19	Capture crossover SUV gen 1	Tailgate
ML2864	RENAULT	April'13-19	Clio	Hatch
ML2868	CITROEN	June'06-Nov'09	C3	Hatch
ML2868	CITROEN	Dec'09-16	C3	Hatch
ML2881  ML2877 	JEEP	93- 98	Jeep Grand Cherokee All (ZJ series) (ML Up- country Susp) Std Height	Tailgate
ML2894	LAND ROVER	end 04-'Oct'09	Discovery 3	Tailgate
ML2894	LAND ROVER	Oct'09-17	Discovery 4	Tailgate
ML2896	KIA	Nov 09-Feb 15	Sorento 4x4 & 4x2 (XM)	Tailgate
ML2903	VOLVO	02-July 15	XC90 AWD SUV gen 1	Tailgate
ML2912 >	AUDI	07-15	TT (8J)	Hatch
ML2925	JEEP	93- 98	Jeep Grand Cherokee All (ZJ series) (ML Up- country Susp) Std Height	Glass
ML2934 > "ML6180"	PEUGEOT	10/12-19	208 Hatch gen 1 (A9)	Hatch
ML2939	OPEL	End 02-Oct'07	Corsa Hatch  Lite) (C)	Hatch
ML2949	JEEP	99-May'05	Jeep Grand Cherokee All (WJ series) (ML Up country susp) Std Height	Tailgate
ML2972	TOYOTA	Nov'02-Sept'07	RunX Hatch gen 9 (E120)	Hatch
ML2985	HONDA	92-95	Ballade Hatch & Sedan Mk5 SR4, EH / EG	Tailgate
ML2989	FORD	00-Oct'04	Focus Hatch Mk1	Hatch
ML2990	TOYOTA	Nov'09-on	Prado J150  elec susp) 3.0 GRJ150, 4.0 KDJ150	Rear Glass
ML2992	BMW	Nov'11-19	1 Series	Hatch
ML2999	HYUNDAI	Feb 15-20	i20 Hatch gen 2 (GB)	Hatch
ML3007	PEUGEOT	02-10	 307 Hatch  cc)	Hatch
ML3017	MERCEDES-BENZ	95-July'02	W210 E Class sedan	Bonnet
ML3017	MERCEDES-BENZ	96-July'02	T210 S/Wagon	Bonnet
ML3020	KIA	Nov 09-Feb 15	Sorento 4x4 & 4x2 (XM)	Bonnet
ML3022	RENAULT	96-Feb'04	Scenic MPV	Rear Glass
ML3027	PEUGEOT	08-14	 308 Hatch  S/W & cc)	Hatch
ML3039	HYUNDAI	08-18	i10 Hatch gen 1 (PA)	Hatch
ML3040	CITROEN	04-11	C2	Hatch
ML3042  > ML3043  >	MAZDA	12-17	CX5 SUV gen 1 (KE)	Tailgate
ML3068	FIAT	08-on	500  500L)	Hatch
ML3070	TOYOTA	03-Oct'09	Prado 120 / 125 Series  elec susp)	Bonnet
ML3072 > "ML6169"	HYUNDAI	07-12	Sante Fe 4X4 Gen 2 (CM)	Tailgate
ML3077	FIAT	04-Feb'12	Punto 1.2, 1.3 JTD, 1.4 Hatch (MkII) (188)	Hatch
ML3077	FIAT	March'12-16	Punto 1.2, 1.3 JTD, 1.4 Hatch (188 facelift)	Hatch
ML3095	VOLKSWAGEN	04-Feb'09	Golf V (1K1)	Hatch
ML3096 >	KIA	09-14	Soul hatch (AM)	Hatch
ML3101 > ML5492	SUZUKI	81-Sept 18	SJ410, SJ413, + SN413 (JA33, JB33),  Samurai	Tailgate
ML3111	JEEP	02-07	Jeep Cherokee 4x4 (KJ)	Rear Glass
ML3115	RENAULT	End 06-March'13	Clio	Hatch
ML3116	KIA	95-04	Sportage 4x4 & 4x2 Gen 1 (K00)	Tailgate
ML3123  ML3124 	HYUNDAI	00-08	Atos Prime  earlier Atos)	Hatch
ML3147	RENAULT	June04-08	 Megane II cc Cabriolet	Boot
ML3153	TOYOTA	07-March'13	Auris hatch (330N)	Hatch
ML3158	CHEVROLET	11-on	Orlando J309 MPV	Tailgate
ML3181	RENAULT	95-'02	 Megane Hatch (ML "Shake it")	Hatch

Key

	See important installation information on inside front cover
	Excluding self-levelling suspension
	Special order - phone 010 900 1850. 6-12 week waiting period

	Imported
	Internal bump stop
	Steering damper

- It is recommended that all new shock absorbers are fitted in pairs
- Do not mix gas and non-gas units on the same axle
- **Bold** part numbers indicate heavy-duty shocks
- Underlined part numbers indicate parts not immediately available
- *Italic* part numbers followed by > indicate parts to be discontinued

Maxlift

Part number [numerical listing]

Part number	Make	Year	Application	Position
ML3183	TATA	04 – 16	Indica 1.4 Hatch (V2) INC1 B-Line	Hatch
ML3183	TATA	10-Apr	Indigo S/Wagon	S/W
ML3184	JEEP	08-'13	Jeep Cherokee 4x4 (KK)	Rear Glass
ML3184	JEEP	07-09	Commander 3.0, 4.7 & 5.6 (XK)	Rear Glass
ML3194	HYUNDAI	14-July 20	Grand i10 Hatch gen 2 (IA / BA)	Hatch
ML3199	VOLKSWAGEN	March'09-13	Golf VI (5K1)	Hatch
ML3207 > ML6324	TOYOTA	98-07	Landcruiser 100 Series S/Wagon IFS, INC1 Lexus IFS & Torsion Bars	Bonnet
ML3208	BMW	Nov 15-Oct 22	X1 SUV gen 2	Bonnet
ML3210 >	JEEP	March'11-on	Jeep Grand Cherokee All (WK2 series)	Glass
ML3211	JEEP	02-07	Jeep Cherokee 4x4 (KJ)	Bonnet
ML3215	SUZUKI	End 08-March'14	SX4 2.0 4x2 & 4x4 SUV	Hatch
ML3231 > ML3232 >	SUZUKI	08-10	Swift hatch (gen 3)	Tailgate
ML3235 > ML3236 >	MERCEDES-BENZ	June14- June 21	W205 C Class sedan	Bonnet
ML3235 > ML3236 >	MERCEDES-BENZ	Mid 16-April 23	E Class W213 sedan	Bonnet
ML3248	HONDA	08-15	Jazz gen 2 (GE)	Hatch
ML3250	TOYOTA	11-on	EJ Cruiser	Rear Glass
ML3270	RENAULT	09-Aug 16	Megane III Hatch	Hatch
ML3275 > ML3358	TOYOTA	11-on	EJ Cruiser	Bonnet:
ML3304	AUDI	08-Jan 16	A4 Sedan & Avant (B8)	Boot
ML3311	VOLVO	June'04-12	S40 Sedan & V50 S/W INC1 T5 (Gen 2)	Tailgate (V50)
ML3312	RENAULT	16-18	Kadjar crossover SUV	Tailgate
ML3318	CHEVROLET	07-March'11	Captiva SUV (C100)	Bonnet
ML3318	CHEVROLET	April'11-18	Captiva SUV (T300)	Bonnet
ML3320	BMW	13-18	3 series (F30) sedan	Boot
ML3348	OPEL	Sept'04-09	Astra (model H)	Hatch
ML3355	JEEP	07-10	Patriot 4x4 (MK)	Tailgate
ML3356	JEEP	11-18	Patriot (MK2 – Facelift)	Tailgate
ML3362 >	CITROEN	11-18	DS3 1.6i	Hatch
ML3367	HYUNDAI	09-Jan 15	i20 Hatch gen 1 (PB)	Hatch
ML3381 > ML3377 >	TOYOTA	90-98	Landcruiser 80 series S/Wagon (INC1 certain solid axle 105 series '98-'07 models)	Bonnet
ML3383	RENAULT	03-08	Megane II Sedan & Hatch All INC1 Shake it	Hatch
ML3386	BMW	07-13	X5	Bonnet
ML3386	BMW	09-Jan 15	X6 Cross-over vehicle	Bonnet
ML3387	BMW	End 04-Oct'11	1 Series	Hatch
ML3393	TOYOTA	90-98	Landcruiser 80 series S/Wagon (INC1 certain solid axle 105 series '98-'07 models)	Tailgate
ML3397	RENAULT	99-12	Clio (INC1 Va va vroom)	Hatch
ML3407	VOLKSWAGEN	04-May 15	Caddy All (2KA) gen 3	Bonnet
ML3410	CHEVROLET	05-July'10	Spark (M200, M250) INC1 Lite 2010-on	Hatch
ML3410	CHEVROLET	Aug'10-on	Spark LITE (M200, M250)	Hatch
ML3442	RENAULT	13-Sept 18	Duster SUV gen 1	Tailgate
ML3450 > ML3451 >	NISSAN	Aug'06-13	Tiida 1.6 & 1.8 Hatch / Sedan (X11C) Gen 1	Hatch
ML3458	LAND ROVER	end 04-'Oct'09	Discovery 3	Bonnet
ML3458	LAND ROVER	Oct'09-17	Discovery 4	Bonnet
ML3458	LAND ROVER	05-12	Range Rover Sport (L320)	Bonnet
ML3471 > "ML5706"	KIA	99-04	Carnival MPV GQ (gen 1)	Bonnet

Key

*	See important installation information on inside front cover
!	Excluding self-levelling suspension
"..."	Special order – phone 010 900 1850. 6-12 week waiting period

~	Imported
#	Internal bump stop
⊕	Steering damper

- It is recommended that all new shock absorbers are fitted in pairs
- Do not mix gas and non-gas units on the same axle
- **Bold** part numbers indicate heavy-duty shocks
- Underlined part numbers indicate parts not immediately available
- *Italic* part numbers followed by > indicate parts to be discontinued

Maxlift

Part number [numerical listing]

Part number	Make	Year	Application	Position
ML3475	BMW	March'05-12	3 series (E90) 320i, 320d, 323i, 325i, 330d & 330i (S) M3, Cabrio & Coupe	Bonnet '05-'11
ML3475	BMW	07-12	 330i, 335i Cabriolet (S) M3, Coupe & sedan) (E93)	Bonnet '05-'11
ML3475	BMW	07-12	 320i, 325i, 335i Coupe (S) M3, Cabrio & Sedan) (E92)	Bonnet '05-'11
ML3479	NISSAN	05-15	Pathfinder 2.5 Dci, 4.0 4x4 SUV (R51)	Glass
ML3507	VOLKSWAGEN	Aug'04 – 15	Type V Caravelle, Kombi, Transporter, Crew bus & Van T5 (M) 4Motion 4WD (front engine)	Bonnet
ML3511	CHEVROLET	03-11	Aveo T200 & T250 (gen one)	Tailgate
ML3526	JEEP	June'05 – Feb'11	Jeep Grand Cherokee All (WK series) (S) up country / raised susp)	Glass
ML3530	HYUNDAI	04 – 10	Tucson (JM)	Rear Glass
ML3534 >	NISSAN	end 08-15	Murano 3.5 V6 4x4 SUV (Gen 2)	Bonnet
ML3545 (B) > ML3549 (I) >	TOYOTA	86-92	Cressida Sedan (M) 2,8 & 3,0 I.R.S.)	Bonnet
ML3545 (B) > ML3549 (I) >	TOYOTA	86-92	Cressida S/Wagon	Bonnet
ML3546	CHEVROLET	Aug'10-on	Spark (M300)	Hatch
ML3547 >	TOYOTA	81-93	Cressida Sedan X35, X36 (Mk1)	Bonnet
ML3547 >	TOYOTA	Mid 81-85	Cressida S/Wagon (Local Strut)	Bonnet
ML3551	VOLKSWAGEN	05 – 11	  Passat Sedan & S/Wagon (B6)	Boot
ML3556	BMW	End 04-Oct'11	1 Series	Bonnet
ML3560 >	NISSAN	05-end 08	Murano 3.5 V6 4x4 SUV (Gen 1)	Bonnet
ML3566 >	HUMMER	05-11	H3	Bonnet
ML3579	BMW	March'05-12	3 series (E90) 320i, 320d, 323i, 325i, 330d & 330i (S) M3, Cabrio & Coupe	Boot
ML3581	JEEP	99-May'05	Jeep Grand Cherokee All (WJ series) (M) Up country susp) Std Height	Glass
ML3584	TOYOTA	April'13-19	Auris hatch	Hatch
ML3596	RENAULT	13-19	Capture crossover SUV gen 1	Bonnet
ML3602	JEEP	14-21	New Jeep Cherokee 4x4 Trailhawk (KL)	Bonnet
ML3610	BMW	13-18	X5	Bonnet
ML3610	BMW	Feb 15-on	X6 Cross-over vehicle	Bonnet
ML3619 (B) > ML3618 (I) >	TOYOTA	96-01	Export Camry (Japan mnf) SXV20, MCV20, XV20 gen 5	Bonnet
ML3624	AUDI	15-on	TT (FV)	Bonnet
ML3656	VOLVO	Aug 15-23	XC90 AWD SUV gen 2	Bonnet
ML3657	BMW	91-99	316i, 318i, 318is, 318tds, 320i, 323i, 325i, 325td, 325tds, 328i Imported & Local Strut. (M) Cabrio. (S) M3). (E36)	Bonnet
ML3680	SUZUKI	09-15	Alto hatch 1.0 (gen 7) HA25	Tailgate
ML3689 (B) > ML3693 (I) >	TOYOTA	93-Aug 01	Camry (RSA mnf) V30, XV10 gen 3	Bonnet
ML3690	RENAULT	March'04-end 09	Scenic II and Grand Scenic II (LWB)	Tailgate
ML3719 > "ML5910"	HONDA	02-06	CR-V 4x4 2.0, 2.2 gen 2 (RD)	Glass
ML3721	KIA	03-Oct 09	Sorento 4x4 & 4x2 (JC)	Rear Glass
ML3733	BMW	99 – Feb'05	All 3 Series (E46) (S) S/W, Compact hatch, M3, cabrio, coupe, & sport susp)	Boot
ML3733	BMW	99-06	 325Ci, 330Ci Coupe (S) Sport Pac II & M3) (E46)	Boot
ML3734	JEEP	June'05 – Feb'11	Jeep Grand Cherokee All (WK series) (S) up country / raised susp)	Bonnet
ML3756	BMW	10-Oct 15	X1 SUV gen 1	Bonnet
ML3786	AUDI	11-18	A7 Sportback (4GA, 4GF)	Bonnet
ML3815 > ML5488	VOLVO	June'04-12	S40 Sedan & V50 S/W (M) T5 (Gen 2)	Boot (S40)
ML3820	AUDI	08-Jan 16	A5 Coupe & Cabriolet (BT)	Boot
ML3828	LAND ROVER	99- end 04	Discovery 2	Bonnet
ML3828	LAND ROVER	April 07-15	Freelander II (L359)	Bonnet
ML3840	VOLVO	March'00-07	V70 S/Wagon Gen 2	Tailgate
ML3840	VOLVO	Feb'00-July 07	XC70 AWD SUV	Tailgate

Key

*	See important installation information on inside front cover
!	Excluding self-levelling suspension
"..."	Special order – phone 010 900 1850. 6-12 week waiting period

~	Imported
#	Internal bump stop
⊕	Steering damper

- It is recommended that all new shock absorbers are fitted in pairs
- Do not mix gas and non-gas units on the same axle
- **Bold** part numbers indicate heavy-duty shocks
- Underlined part numbers indicate parts not immediately available
- *Italic* part numbers followed by > indicate parts to be discontinued

Maxlift

Part number [numerical listing]

Part number	Make	Year	Application	Position
ML3840	VOLVO	Aug'07-15	XC70 AWD SUV	Tailgate
ML3855	VOLKSWAGEN	04-10	Touareg 4x4 (7L)	Rear Glass
ML3865	BMW	99 – Feb'05	All 3 Series (E46) [EXC] S/W, Compact hatch, M3, cabrio, coupe, & sport susp)	Bonnet
ML3865	BMW	Nov'01-05	All 3 Series Compact (E46) [EXC] sedan)	Bonnet
ML3865	BMW	00- 05	3 Series Touring (E46)	Bonnet
ML3865	BMW	00-06	330Ci Cabriolet [EXC] Sport Pac II & M3) (E46)	Bonnet
ML3865	BMW	99-06	325Ci, 330Ci Coupe [EXC] Sport Pac II & M3) (E46)	Bonnet
ML3886	LAND ROVER	12-May19	Evoque SUV (L538)	Bonnet
ML3902	VOLKSWAGEN	11-15	Passat sedan (B7)	Boot
ML3903	VOLVO	07-10	V70 S/Wagon Gen 3	Tailgate
ML3904	KIA	March 15-on	Sorento 4x4 & 4x2 (UM)	Bonnet
ML3906	LAND ROVER	15-Feb 20	Discovery Sport (L550)	Bonnet
ML3914	AUDI	08 – 17	Q5 4x4 (8R)	Bonnet
ML3916	VOLKSWAGEN	March'06-Sept'11	Jetta V (1K2)	Boot
ML3964	VOLKSWAGEN	June 15-Oct 21	Caddy All (2KA, SA) gen 3 facelift	Bonnet
ML3985	HONDA	92-95	Ballade Hatch & Sedan Mk5 SR4, EH / EG	Boot
ML3995	AUDI	Dec'00- 04	+ A4 Sedan & Avant B6. 8E	Boot
ML3998	VOLVO	07-10	V70 S/Wagon Gen 3	Tailgate
ML3999	BMW	11-17	X3 SUV	Bonnet
ML4001	VOLVO	April'00- May'04	S40 Sedan & V40 S/W [EXC] Sport & T4	Boot
ML4003	AUDI	05-07	(S/W) A4 & Avant [EXC] Cabriolet boot) B7	Boot
ML4014	RENAULT	96- 03	Megane Classic Sedan	Boot
ML4024	VOLVO	10-18	S60 Sedan gen 2	Bonnet
ML4024	VOLVO	11-18	V60 S/Wagon [EXC] Cross Country	Bonnet
ML4032	VOLVO	09-Sept 18	XC60 AWD SUV	Bonnet
ML4036	MINI	11-16	Mini Countryman [EXC] AWD (R60)	Bonnet
ML4036	MINI	13-16	Mini Paceman (R61)	Bonnet
ML4037	BMW	91-99	316i, 318i, 318is, 318tds, 320i, 323i, 325i, 325td, 325tds, 328i Imported & Local Strut. [EXC] Cabrio. [EXC] M3). (E36)	Boot
ML4037	BMW	93-99	M3 (E36)	Boot
ML4037	BMW	93-99	323i, 325i & 328i Cabriolet [EXC] M Tech) (E36)	Boot
ML4063	BMW	01-06	X5	Bonnet
ML4069	JEEP	99-May'05	Jeep Grand Cherokee All (WJ series) ([EXC] Up country susp) Std Height	Bonnet
ML4075	BMW	04-10	X3 SUV	Bonnet
ML4076	BMW	Nov'11-19	1 Series	Bonnet
ML4076	BMW	Nov'14-on	2 Series Coupe, Cabriolet	Bonnet
ML4076	BMW	13-18	3 series (F30) sedan	Bonnet
ML4076	BMW	13-on	3 series (F34) Grand Turismo 5 door Liftback / hatch	Bonnet
ML4076	BMW	13-on	4 Series Coupe, Cabriolet, Gran Coupe (liftback)	Bonnet
ML4111 (opens 255mm)	VOLKSWAGEN	Oct'02-Jan'10	Polo Classic Sedan and Hatch [EXC] CrossPolo (mk 4 9N3)	Boot
ML4125	VOLKSWAGEN	99-04 (Jetta till 2/06)	Golf IV & Jetta IV ([EXC] Estate S/W)	Boot (Jetta)
ML4128	BMW	March'05-12	3 series (E90) 320i, 320d, 323i, 325i, 330d & 330i [EXC] M3, Cabrio & Coupe)	Bonnet '12-'14
ML4128	BMW	07-12	330i, 335i Cabriolet [EXC] M3, Coupe & sedan) (E93)	Bonnet '12-'14
ML4128	BMW	07-12	320i, 325i, 335i Coupe [EXC] M3, Cabrio & Sedan) (E92)	Bonnet '12-'14
ML4135	MERCEDES-BENZ	Mid 04 -July'11	SLK (R171)	Boot
ML4142	VOLVO	00-10	S60 Sedan gen 1	Boot
ML4149	AUDI	95- Jan'99	A4 Sedan 8D, B5	Boot
ML4149	AUDI	Feb'99-Nov'00	A4 Sedan [EXC] Avant S/W) B5, 8D	Boot
ML4149	VOLKSWAGEN	93- 04	Golf III & IV Cabriolet [EXC] 16" wheels)	Boot

Key

*	See important installation information on inside front cover
!	Excluding self-leveling suspension
"..."	Special order – phone 010 900 1850. 6-12 week waiting period

~	Imported
#	Internal bump stop
⊕	Steering damper

- It is recommended that all new shock absorbers are fitted in pairs
- Do not mix gas and non-gas units on the same axle
- **Bold** part numbers indicate heavy-duty shocks
- Underlined part numbers indicate parts not immediately available
- *Italic* part numbers followed by > indicate parts to be discontinued

Maxlift

Part number [numerical listing]

Part number	Make	Year	Application	Position
ML4149 (opens 278mm)	VOLKSWAGEN	Oct'02-Jan'10	Polo Classic Sedan and Hatch MLC CrossPolo (mk 4 9N3)	Boot
ML4164	NISSAN	14-on	NV200 panel van and MPV	Bonnet
ML4164	NISSAN	14-on	NV350 panel van and minibus, MLC Impendulo taxi	Bonnet
ML4208	RENAULT	end 09-16	Scenic & Grand Scenic III MPV 1.6, 1.9dCi	Bonnet
ML4213	VOLKSWAGEN	92-99	Golf III & Jetta III	Boot Jetta
ML4219	MINI	14-24	Mini One, Cooper, Cooper D, Cooper S, One D (F55, F56 Mk III) MLC cabriolet	Bonnet
ML4219	MINI	15-24	Mini Clubman S/Wagon (F54)	Bonnet
ML4235	RENAULT	end 09-16	Scenic & Grand Scenic III MPV 1.6, 1.9dCi	Bonnet
ML4257	BMW	84-91	All 3 Series (E30)	Bonnet
ML4257	BMW	88-94	7 Series (E32) (EXC) M Tech	Bonnet
ML4370	VOLVO	00-10	S60 Sedan gen 1	Bonnet ('01-05)
ML4370	VOLVO	98-July'06	S80 Sedan gen 1	Bonnet
ML4370	VOLVO	March'00-07	V70 S/Wagon Gen 2	Bonnet
ML4380	VOLVO	00-10	S60 Sedan gen 1	Bonnet (05-10)
ML4383	MINI	07-13	Mini One, Cooper, Cooper D, Cooper S, One D (R56, R57 Mk II) MLC cabriolet	Bonnet
ML4383	MINI	08-14	Mini Clubman S/Wagon (R55)	Bonnet
ML4383	MINI	11-15	Mini Coupe (R58) & Roadster Cabriolet (R59)	Bonnet
ML4399	MERCEDES-BENZ	98-05	ML SUV (W163)	Bonnet
ML4404	NISSAN	92- July'01	Sentra 140 (B13)	Boot
ML4404	NISSAN	92- July'01	Sentra & Sabre 160 (B13)	Boot
ML4404	NISSAN	92- July'01	Sentra & Sabre 200 (EXC) ABS (B13)	Boot
ML4404	NISSAN	92- July'01	Sentra & Sabre 200 With ABS (B13)	Boot
ML4429	MERCEDES-BENZ	94 - Aug'01	W202 C Class sedan	Bonnet
ML4429	MERCEDES-BENZ	94 - Aug'01	W202 C Class S/Wagon	Bonnet
ML4483	RENAULT	96-May'04	Megane Coupe	Hatch
ML4486	RENAULT	97 - May'04	Megane Cabriolet	Boot
ML4999	KIA	Oct'10-March 16	Sportage 4x4 & 4x2 2.0, 2.4 Gen 3 (SL)	Tailgate
ML5005	LAND ROVER	15-Feb 20	Discovery Sport (L550)	Tailgate
ML5154	VOLVO	95-April'00	S40 Sedan & V40 S/W MLC Sport & T4	Boot
ML5207	FORD	04-Oct'08	Fiesta Hatch Mk 5 JH, JD 5 door (EXC) 2.5 ST & 3 door	Hatch
ML5207	FORD	10-15	Figgo Hatch gen 1	Hatch
ML5575	VOLKSWAGEN	Aug'04 - 15	Type V Caravelle, Kombi, Transporter, Crew bus & Van T5 MLC 4Motion 4WD (front engine)	Tailgate (Bus / Kombi)
ML5651	FORD	Nov'08-17	Fiesta Hatch Mk 6 (EXC) 2.5 ST	Hatch
ML5651	FORD	15-on	Figgo Hatch gen 2	Hatch
ML5777	TOYOTA	05 - Sept'11	Yaris Hatch & Sedan (NBC2) gen 2 (P90)	Hatch
ML5832	VOLKSWAGEN	16 - 0n	Type VI Caravelle, Kombi, Transporter, Crew bus & Van T6 MLC 4Motion 4WD (front engine)	Bonnet
ML5911	HONDA	03-04	Jazz gen 1 (GD)	Hatch
ML5911	HONDA	05-07	Jazz gen 1 (GD facelift)	Hatch
ML6005	LAND ROVER	April 07-15	Freelander II (L359)	Tailgate
ML6086	SUZUKI	08-10	Swift hatch (gen 3)	Tailgate
ML6152	VOLKSWAGEN	04-May 15	Caddy All (2KA) gen 3	Bonnet
ML6153	AUDI	11-May 18	A1 (8X) gen 1	Hatch
ML6154	AUDI	11-May 18	A1 (8X) gen 1	Bonnet
ML6156	AUDI	11 -18	Q3 2x4 & 4x4 (8U)	Bonnet
ML6157	AUDI	11 -18	Q3 2x4 & 4x4 (8U)	Hatch
ML6170	KIA	July11-June 17	Picanto Hatch (TA)	Hatch
ML6172	MERCEDES-BENZ	April'12-18	B180, B200 (W246)	Hatch
ML6173	MERCEDES-BENZ	Sept'00-April'07	W203 C Class sedan	Boot

Key

*	See important installation information on inside front cover
!	Excluding self-levelling suspension
"..."	Special order - phone 010 900 1850. 6-12 week waiting period

~	Imported
#	Internal bump stop
⊕	Steering damper

- It is recommended that all new shock absorbers are fitted in pairs
- Do not mix gas and non-gas units on the same axle
- **Bold** part numbers indicate heavy-duty shocks
- Underlined part numbers indicate parts not immediately available
- *Italic* part numbers followed by > indicate parts to be discontinued

Maxlift

Part number [numerical listing]

Part number	Make	Year	Application	Position
ML6184	TOYOTA	Oct'11-19	Yaris Hatch & Sedan gen 3 (P130)	Hatch
ML6184	TOYOTA	18-21	Yaris Hatch & Sedan gen 3 (P150)	Hatch
ML6189	VOLKSWAGEN	13-on	Up hatch	Hatch
ML6196	SUZUKI	April 14-17	SX4 2.0 4x2 & 4x4 SUV	Hatch
ML6200	RENAULT	13-20	Sandero hatch	Hatch
ML6209	LAND ROVER	05-12	Range Rover Sport (L320)	Tailgate
ML6305	LAND ROVER	13-22	Range Rover Sport (L494)	Tailgate
ML6345	TOYOTA	08-on	Landcruiser 200 Series S/Wagon	Bonnet
ML6440	AUDI	Feb 16-on	 A4 Sedan (B9, 8W)	Bonnet
ML6440	AUDI	Feb 16-on	A5 Coupe & Cabriolet (B9)	Bonnet
ML6450	HONDA	15-May 21	Jazz gen 3 (GK)	Hatch

Key

*	See important installation information on inside front cover
!	Excluding self-levelling suspension
"..."	Special order – phone 010 900 1850. 6-12 week waiting period

~	Imported
#	Internal bump stop
⊕	Steering damper

- It is recommended that all new shock absorbers are fitted in pairs
- Do not mix gas and non-gas units on the same axle
- **Bold** part numbers indicate heavy-duty shocks
- Underlined part numbers indicate parts not immediately available
- *Italic* part numbers followed by > indicate parts to be discontinued

Maxlift

Part number [numerical listing]

Part number	Make	Year	Application	Position
SPECIAL ORDER				
"M5312"	VOLVO	97- 98	V90 S/Wagon gen 1 (300 XC90 4WD Cross Country)	Tailgate
"M6084"	DAIHATSU	March'05-10	Sirion 1.3 & 1.5 hatch M300	Tailgate
"ML0266"	HYUNDAI	06-11	Azera sedan 3.3 V6	Bonnet
"ML1020"	VOLVO	97- 98	S90 Sedan	Bonnet
"ML3470"	HYUNDAI	06-11	Azera sedan 3.3 V6	Boot
"ML3610"	BMW	00-06	 330Ci Cabriolet (300 Sport Pac II & M3) (E46)	Roof
"ML3611"	BMW	00-06	 330Ci Cabriolet (300 Sport Pac II & M3) (E46)	Roof
"ML4068" > "ML5663"	VOLVO	07-10	V70 S/Wagon Gen 3	Bonnet
"ML4068" > "ML5663"	VOLVO	Aug'07-15	XC70 AWD SUV	Bonnet
"ML4421"	FIAT	03-10	Multipla MPV 1.6, 1.9JTD (300 Bi-power)	Bonnet
"ML5038"	FIAT	03-10	Stilo Hatch (192) (Check OE #'s, length & pressure before ordering)	Hatch
"ML5081"	FIAT	Sept'01-06	Seicento 1100 (187)	Hatch
"ML5101"	FIAT	04-on	Panda (169) 1.2, 1.3 (300 AWD & 1.4 100HP)	Hatch
"ML5101"	FIAT	04-10	Panda (169) 1.3 Climbing AWD	Hatch
"ML5113"	PEUGEOT	99-08	Partner Grand Raid MPV (DW8B & DW10TD)	Tailgate
"ML5113"	PEUGEOT	09-08	Partner Panel Van	Tailgate
"ML5119"	OPEL	03-09	Meriva mini MPV (A)	Hatch
"ML5135"	AUDI	00-06	TT (BN)	Bonnet
"ML5135"	VOLKSWAGEN	99-05	 Passat Sedan (B5)	Boot
"ML5136"	FORD	05-09	Ka 1.3 Hatch	Hatch
"ML5164"	FIAT	04-10	Punto 1.8 HGT 1.6v 3 door Hatch, plus 1.4 Sport Susp (MkII) (188)	Hatch
"ML5177"	NISSAN	end 08-15	Murano 3.5 V6 4x4 SUV (Gen 2)	Tailgate
"ML5180"	PEUGEOT	95-'04	 406 Sedan	Boot
"ML5183"	PEUGEOT	95-'04	 406 Sedan	Boot
"ML5193"	VOLKSWAGEN	99-05	 Passat Sedan (B5)	Boot
"ML5205"	FORD	04-Oct'08	Fiesta Hatch Mk 5 JH, JD 3 door 2.5 ST (300 5 door)	Hatch
"ML5213"	BMW	00- 05	3 Series Touring (E46)	Tailgate
"ML5222"	ALFA ROMEO	June'01-10	147 1.6TS, 1.9JTD & 2.0TS hatch	Hatch
"ML5245"	VOLKSWAGEN	90- July'04	Type IV Caravelle T4 (100) 2.5 Tdi, Transporter & Syncro 4WD (front engine)	Tailgate
"ML5259"	VOLKSWAGEN	98-Sept'02	Polo Classic Sedan & Playa Hatch (mk 3) (300 sport susp	Boot
"ML5267"	PEUGEOT	98-01	306 Hatch (300 cc)	Bonnet
"ML5267"	PEUGEOT	98-'02	306 S/Wagon (300 cc)	Bonnet
"ML5280"	FIAT	03-10	Stilo Hatch (192) (Check OE #'s, length & pressure before ordering)	Hatch
"ML5281"	FIAT	03-10	Stilo Hatch (192) (Check OE #'s, length & pressure before ordering)	Hatch
"ML5290"	FORD	98-01	Mondeo sedan mkII	Boot
"ML5297"	HYUNDAI	01-06	Sante Fe 4X4 Gen 1 (SM)	Glass
"ML5306"	LAND ROVER	76-96	Range Rover I Classic	Tailgate
"ML5307"	MERCEDES-BENZ	94 - Aug'01	W202 C Class S/Wagon	Tailgate
"ML5308"	MERCEDES-BENZ	98-March'02	 CLK320 & CLK430 Coupe (C208)	Bonnet
"ML5308"	MERCEDES-BENZ	98-02	 CLK320 & CLK430 Cabriolet (C208)	Bonnet
"ML5319"	PEUGEOT	96-'04	(S/W) 406 Estate S/Wagon	Tailgate
"ML5334"	SSANG YONG	02-12	Rexton I & II 270, 290TD, E320 4x4 SUV	Tailgate
"ML5336"	BMW	96-'03	5 Series (E39) (300 M5, M Tech & S/W)	Bonnet
"ML5340"	PEUGEOT	02-12	206 S/Wagon	Rear Window
"ML5343"	PEUGEOT	02-May'07	206 Cabrio cc	Boot
"ML5355"	SSANG YONG	02-12	Rexton I & II 270, 290TD, E320 4x4 SUV	Bonnet

Key

*	See important installation information on inside front cover
!	Excluding self-levelling suspension
"..."	Special order - phone 010 900 1850, 6-12 week waiting period

~	Imported
#	Internal bump stop
⊕	Steering damper

- It is recommended that all new shock absorbers are fitted in pairs
- Do not mix gas and non-gas units on the same axle
- **Bold** part numbers indicate heavy-duty shocks
- Underlined part numbers indicate parts not immediately available
- *Italic* part numbers followed by > indicate parts to be discontinued

Maxlift

Part number [numerical listing]

Part number	Make	Year	Application	Position
SPECIAL ORDER				
"ML5382"	HYUNDAI	01-06	Sante Fe 4X4 Gen 1 (SM)	Bonnet
"ML5421"	BMW	93-99	323i, 325i & 328i Cabriolet (301 M Tech) (E36)	Bonnet
"ML5448"	FIAT	03-10	Doblo Cargo panel Van (223)	Tailgate
"ML5470"	PEUGEOT	95-04	406 Sedan	Bonnet
"ML5470"	PEUGEOT	96-04	(S/W) 406 Estate S/Wagon	Bonnet
"ML5471"	PEUGEOT	97-Feb'06	406 Coupe	Tailgate
"ML5480"	VOLKSWAGEN	98-07	Sharan MPV	Bonnet
"ML5487"	VOLVO	97-05	C70 Coupe & Cabrio	Boot (Coupe)
"ML5489"	VOLVO	98-July'06	S80 Sedan gen 1	Boot
"ML5490"	VOLVO	98-July'06	S80 Sedan gen 1	Boot
"ML5516"	OPEL	07-14	Vivaro van & minibus (X83)	Tailgate
"ML5517"	PEUGEOT	97-Feb'06	406 Coupe	Bonnet
"ML5523"	BMW	94-02	7 Series (E38)	Boot
"ML5529"	VOLVO	97- Feb'00	V70 S/Wagon Gen1	Tailgate
"ML5560"  "ML5577" 	MERCEDES-BENZ	April'02-09	CLK320, CLK350 & CLK500 Coupe (C209)	Bonnet
"ML5560"  "ML5577" 	MERCEDES-BENZ	02 - 09	CLK320, CLK350 & CLK500 Cabriolet (A209)	Bonnet
"ML5562"	BMW	Nov'03-May'10	All E60 5 Series sedan (301 Touring S/W, M5)	Bonnet
"ML5562"	BMW	04-'10	All E61 5 Series Touring S/W	Bonnet
"ML5565"	BMW	Mid 02-Feb'09	730d, 735i, 740i, 745i, 750i (E65)	Bonnet
"ML5567"	HONDA	89-91	Ballade Hatch Mk4 SH4 / EF / EC / ED	Tailgate
"ML5590"	BMW	96-'03	5 Series (E39) (301 M5, M Tech & S/W)	Boot
"ML5643"	VOLVO	Feb'00-July'07	XC70 AWD SUV	Bonnet
"ML5649"	LAND ROVER	94-on April'02	Range Rover II Pegasus (P38A)	Tailgate
"ML5650"	FORD	11-12	Kuga SUV (I)	Rear Glass
"ML5654"	FORD	11-12	Kuga SUV (I)	Hatch
"ML5655"	ALFA ROMEO	09-18	MiTo hatch 1.4, 1.4T, 1.6JTD	Hatch
"ML5660"	HYUNDAI	13-18	Sante Fe 4X4 Gen 3 (DM)	Bonnet
"ML5663"	VOLVO	Aug'06-14	S80 Sedan gen 2	Bonnet
"ML5674"	MERCEDES-BENZ	96-July'02	T210 S/Wagon	Tailgate
"ML5680"	MERCEDES-BENZ	96-Mid 04	SLK (R170)	Boot
"ML5687"	PEUGEOT	07-15	107 Hatch	Hatch
"ML5689"	BMW	07-12	320i, 325i, 335i Coupe (301 M3, Cabrio & Sedan) (E92)	Boot
"ML5689"	NISSAN	98-17	Patrol S/W 4x4 GR I & II / GU I & II Y61 Series (Coil springs)	Bonnet
"ML5696"	ALFA ROMEO	June'01-10	147 1.6TS, 1.9JTD & 2.0TS hatch	Bonnet
"ML5706"	KIA	04 - April'07	Sedona MPV gen 1 (GQ)	Bonnet
"ML5708"	KIA	April'04-June'11	Picanto Hatch (SA)	Hatch
"ML5719"	MERCEDES-BENZ	May'07-May 14	W204 C Class S/Wagon	Tailgate Power
"ML5724"	RENAULT	05 - 08	Modus 1.2, 1.4, 1.6 Hatch / mini MPV	Hatch
"ML5727"	PEUGEOT	Mid 04-10	407 Sedan	Boot
"ML5728"	PEUGEOT	End 04-08	407 S/Wagon	Tailgate
"ML5729"	PEUGEOT	End 04-08	407 S/Wagon	Rear Glass
"ML5730"	PEUGEOT	06-08	1007 Harch	Hatch
"ML5736"	VOLKSWAGEN	04-10	Touran MPV gen 1 (1T)	Bonnet
"ML5736"	VOLKSWAGEN	11 - 16	Touran MPV gen 1 facelift (1T)	Bonnet
"ML5737"	AUDI	July'04-11	A6 Sedan & Avant (C6)	Bonnet
"ML5738"	VOLKSWAGEN	07-on	Eos Cabriolet	Bonnet

Key

* See important installation information on inside front cover
! Excluding self-leveling suspension
"..." Special order - phone 010 900 1850. 6-12 week waiting period

~ Imported
Internal bump stop
⊕ Steering damper

- It is recommended that all new shock absorbers are fitted in pairs
- Do not mix gas and non-gas units on the same axle
- **Bold** part numbers indicate heavy-duty shocks
- Underlined part numbers indicate parts not immediately available
- *Italic* part numbers followed by > indicate parts to be discontinued

Maxlift

Part number [numerical listing]

Part number	Make	Year	Application	Position
SPECIAL ORDER				
"ML5740"	AUDI	07-15	TT (8J)	Bonnet
"ML5744"	AUDI	July'04-11	A6 Sedan & Avant (C6)	Boot Manual
"ML5746"	AUDI	July'04-11	A6 Sedan & Avant (C6)	Tailgate
"ML5752"	VOLKSWAGEN	07-on	Eos Cabriolet	Boot
"ML5752"	NISSAN	11-June 18	Micra (K13) gen 4	Hatch
"ML5755"	CITROEN	08-13	C4 Picasso MPV	Tailgate
"ML5755"	CITROEN	13-18	C4 Picasso MPV	Tailgate
"ML5756"	CITROEN	08-13	C4 Picasso MPV	Tailgate
"ML5764"	MAZDA	04-09	Mazda 3 (BK)	Boot
"ML5775"	FIAT	06-16	Grand Punto 1.2, 1.3, 1.4 & 1.9 (199)	Hatch
"ML5776"	PEUGEOT	09-10	4007 SUV	Tailgate
"ML5780"	BMW	97-'03	Z3 (E36, E37 E38)	Boot
"ML5783"	CITROEN	13-18	C4 Picasso MPV	Tailgate
"ML5784"	FIAT	07-on	Bravo (198 generation II) 1.4, 1.9 300 sport susp)	Hatch
"ML5786"	FORD	Nov'04-July'11	Focus Hatch & Sedan MkII	Boot
"ML5795"	FIAT	06-09	Croma (generation II)	S/Tailgate
"ML5798"  "ML5799" 	MERCEDES-BENZ	Aug'11-20	SLK (R172)	Bonnet
"ML5808"	MERCEDES-BENZ	02 - 09	 CLK320, CLK350 & CLK500 Cabriolet (A209)	Boot
"ML5821"	TOYOTA	99-05	Yaris / Vitz Hatch 300 1.5 T-Sport (Cross border - non RSA) gen 1 (P10)	Hatch
"ML5827"	OPEL	Nov'07-Oct 15	Corsa Hatch 300 Lite) (D)	Hatch
"ML5831"	VOLKSWAGEN	05 - 11	  Passat Sedan & S/Wagon (B6)	Tailgate S/W
"ML5851"	PEUGEOT	June'07-12	207 Cabrio cc	Boot
"ML5861"	BMW	04-09	Z4 (E85)	Boot E85 Cabrio
"ML5862"	CITROEN	10-13	C3 Picasso	Tailgate
"ML5872"	LAND ROVER	May'02-12	Range Rover III 300 Sport (L322)	Tailgate
"ML5889"	SSANG YONG	06-12	Kyron 4x4 SUV 300 4x2 = special order)	Tailgate
"ML5889" (manual)	PEUGEOT	08-10	(S/W) 308 1.6 S/Wagon 300 Hatch & cc)	Tailgate S/W
"ML5891"	RENAULT	08-13	Twingo hatch (gen 2)	Hatch
"ML5895"	SMART	End 04-07	ForFour 1.3 Pulse & 1.5 Passion	Hatch
"ML5917"	TOYOTA	04-March'09	Prius Hybrid (NHW20, XW20) gen 2	Hatch
"ML5929"	AUDI	06 - 15	Q7 4x4 (4L)	Manual Tailgate
"ML5934"	BMW	88-94	7 Series (E32) 300 M Tech)	Boot
"ML5948"	CITROEN	08-18	Berlingo 4 van (B9)	Tailgate
"ML5948"	PEUGEOT	09-18	Partner Tepee 8 seater	Tailgate
"ML5948"	PEUGEOT	09-on	Partner Panel Van	Tailgate
"ML5954"	CITROEN	08-18	Berlingo 4 van (B9)	Rear Glass
"ML5954"	PEUGEOT	09-18	Partner Tepee 8 seater	Rear Glass
"ML5956"	CITROEN	08-18	Berlingo 4 van (B9)	Rear Glass
"ML5956"	PEUGEOT	09-18	Partner Tepee 8 seater	Rear Glass
"ML5977"	FORD	09-10	Ka 1.3 Hatch	Hatch
"ML6004"	LAND ROVER	May'02-12	Range Rover III 300 Sport (L322)	Bonnet
"ML6011"	MAZDA	08-12	Mazda 6 (GH)	Bonnet
"ML6014"	MAZDA	03-07	Mazda 6 (GG)	Boot
"ML6016"	MERCEDES-BENZ	May'07-May 14	W204 C Class S/Wagon	Tailgate Manual
"ML6032"	MERCEDES-BENZ	96-Mid 04	SLK (R170)	Bonnet
"ML6040"	NISSAN	92-03	Micra (K11) cross border applications gen2	Hatch
"ML6058" (Auto)	PEUGEOT	08-10	(S/W) 308 1.6 S/Wagon 300 Hatch & cc)	Tailgate S/W

Key

*	See important installation information on inside front cover
!	Excluding self-levelling suspension
"..."	Special order - phone 010 900 1850, 6-12 week waiting period

~	Imported
#	Internal bump stop
⊕	Steering damper

- It is recommended that all new shock absorbers are fitted in pairs
- Do not mix gas and non-gas units on the same axle
- **Bold** part numbers indicate heavy-duty shocks
- Underlined part numbers indicate parts not immediately available
- *Italic* part numbers followed by > indicate parts to be discontinued

Maxlift

Part number [numerical listing]

Part number	Make	Year	Application	Position
SPECIAL ORDER				
"ML6060"	PEUGEOT	08-10	(S/W) 308 1.6 S/Wagon (300) Hatch & cc)	Rear Glass S/W
"ML6068"	PORSCHE	03-10	Cayenne 4x4 SUV (9PA)	Rear Glass
"ML6069"	PORSCHE	03-10	Cayenne 4x4 SUV (9PA)	Bonnet
"ML6072"	RENAULT	09-Aug 16	Megane III cc Coupe and Cabriolet	Tailgate Coupe
"ML6083"	SMART	03-07	ForTwo (450) gen 1	Hatch
"ML6083"	SMART	08-14	ForTwo (451) gen 2	Hatch
"ML6100"	VOLKSWAGEN	09-17	Scirocco (137)	Hatch
"ML6104"	AUDI	July'04-11	A6 Sedan & Avant (C6)	Power Boot
"ML6118"	KIA	May'07-14	Sedona MPV gen 2 (VQ)	Bonnet
"ML6123"	PEUGEOT	09-17	3008 MPV Crossover gen 1	Tailgate
"ML6124"	PEUGEOT	11-14	5008 1.6 THP MPV	Tailgate
"ML6134"	TOYOTA	April'09-16	Prius Hybrid (ZWW30) gen 3	Hatch
"ML6164"	CITROEN	11-16	DS4	Hatch
"ML6169"	HYUNDAI	13-18	Sante Fe 4X4 Gen 3 (DM)	Tailgate
"ML6173"	MERCEDES-BENZ	Sept'00-April'07	W203 C Class S/Wagon	Tailgate
"ML6179"	OPEL	10-17	Meriva mini MPV (B)	Hatch
"ML6188"	VOLKSWAGEN	11 - 16	Touran MPV gen 1 facelift (1T)	Tailgate
"ML6190"	ALFA ROMEO	10-20	Giulietta (940)	Boot
"ML6191"	ALFA ROMEO	10-20	Giulietta (940)	Bonnet
"ML6192"	AUDI	11-19	A6 Sedan & Avant (C7)	Power Tailgate
"ML6193"	AUDI	11-19	A6 Sedan & Avant (C7)	Bonnet
"ML6195"	CHRYSLER	01-07	Voyager 2.0 & 2.4 SWB; & Grand Voyager 2.8, 3.3 V6 & 2.5TD LWB	Tailgate
"ML6201"	FIAT	10-on	Doblo Cargo panel Van (263)	Tailgate
"ML6204"	JAGUAR	08-16	XF 2.7D, 3.0, 4.2, 5.0 (300) XFR	Boot
"ML6205"	JAGUAR	08-16	XF 2.7D, 3.0, 4.2, 5.0 (300) XFR	Bonnet
"ML6215"	RENAULT	April'13-19	Clio	Bonnet
"ML6226"	AUDI	11-19	A6 Sedan & Avant (C7)	Manual Tailgate
"ML6234"	KIA	May'07-14	Sedona MPV gen 2 (VQ)	Tailgate
"ML6276"	FIAT	14-18	500L (300) std 500)	Hatch
"ML6277"	FIAT	14-18	500L (300) std 500)	Hatch
"ML6281"	FIAT	14-18	500L (300) std 500)	Hatch
"ML6289"	NISSAN	98-17	Patrol S/W 4x4 GR I & II / GU I & II Y61 Series (Coil springs)	Bonnet
"ML6297"	FORD	13-23	Tourneo & Transit Connect	Tailgate (300) rear window)
"ML6312" (*) "ML6313" (*)	MERCEDES-BENZ	08-12	GL 4X4 SUV (X164)	Bonnet
"ML6318"	NISSAN	end 08-15	Murano 3.5 V6 4x4 SUV (Gen 2)	Tailgate
"ML6319"	PORSCHE	11-17	Cayenne 4x4 SUV (92A)	Bonnet
"ML6323"	TOYOTA	9/01-06	Camry (Australian mnf) ACV30, ACV31, ACV36, MCV30, MCV36, XV30 gen 6	Bonnet
"ML6333"	BMW	June'10-16	F10 5 Series sedan (300) Touring S/W)	Bonnet
"ML6351"	BMW	13-on	4 Series Coupe, Cabriolet, Gran Coupe (liftback)	Boot
"ML6352"	CITROEN	13-17	C4 Cactus	Tailgate
"ML6355"	BMW	Nov'14-16	2 Series Active Tourer MPV	Bonnet
"ML6360"	PEUGEOT	13-19	2008 SUV (A94)	Tailgate
"ML6362"	OPEL	Nov'15-19	Corsa Hatch (E)	Hatch
"ML6365"	VOLKSWAGEN	15-19	Passat sedan (B8)	Bonnet
"ML6372"	FIAT	11-on	Panda (312) 1.2 (300) AWD & 1.4 100HP)	Hatch
"ML6394"	OPEL	14-19	Adam hatch (M13)	Hatch

Key



*	See important installation information on inside front cover
!	Excluding self-leveling suspension
"..."	Special order - phone 010 900 1850. 6-12 week waiting period

~	Imported
#	Internal bump stop
⊕	Steering damper

- It is recommended that all new shock absorbers are fitted in pairs
- Do not mix gas and non-gas units on the same axle
- **Bold** part numbers indicate heavy-duty shocks
- Underlined part numbers indicate parts not immediately available
- *Italic* part numbers followed by > indicate parts to be discontinued

Maxlift

Part number [numerical listing]

Part number	Make	Year	Application	Position
SPECIAL ORDER				
"ML6395"	HONDA	06-Aug 16	 CivicHatch Mk8 (FN, FK)	Hatch (5 door)
"ML6398"	VOLKSWAGEN	Oct'12-17	New Beetle (Type 2)	Hatch EXCL spoiler)
"ML6420"	CITROEN	12-16	DS5	Hatch
"ML6424"	MAZDA	Mid 09-Sept'14	Mazda 3 (BL)	Boot
"ML6431"	CITROEN	12-16	DS5	Bonnet
"ML6436"	LAND ROVER	94-on April'02	Range Rover II Pegasus (P38A)	Bonnet
"ML6457"	OPEL	June 16-21	 Astra (model K) B16	Hatch
"ML6464"	SMART	14-on	ForTwo (453) gen 3	Hatch
"ML6481"	PORSCHE	14-on	Macan 4x4 SUV (95B)	Bonnet

Key









*	See important installation information on inside front cover
!	Excluding self-levelling suspension
"..."	Special order – phone 010 900 1850. 6-12 week waiting period

~	Imported
#	Internal bump stop
⊕	Steering damper

- It is recommended that all new shock absorbers are fitted in pairs
- Do not mix gas and non-gas units on the same axle
- **Bold** part numbers indicate heavy-duty shocks
- Underlined part numbers indicate parts not immediately available
- *Italic* part numbers followed by > indicate parts to be discontinued

Protection kits

Part number [numerical listing]

Part number	Make	Year	Application	Position
63619	Multiple	Various	Monroe Universal Protection Kit for 20mm & 22mm piston rod OD	Both
63631MM	NISSAN	Aug'06 -13	Tiida 1.6 & 1.8 Hatch / Sedan gen 1 (X11C)	Front
63631MM	NISSAN	Aug'06 -13	Tiida 1.6 & 1.8 Hatch / Sedan gen 1 (X11C)	Front
AK247*	LAND ROVER	05-12	Range Rover Sport air susp gen 1 (L320)	Front
AK247*	LAND ROVER	end 04-June 17	Discovery 3 & 4 Air susp (L319)	Rear
AK247*	LAND ROVER	05-12	Range Rover Sport air susp gen 1 (L320)	Rear
AK247*	LAND ROVER	13-on	Range Rover Sport air susp gen 2 (L494) EXC SVR	Rear
*Replacement kit required when replacing the airsprings				
PK001	VOLKSWAGEN	81-09	Golf LDV INC old Caddy and Citi Pick-Up	Front
PK001	VOLKSWAGEN	81-87	  Passat Sedan & S/Wagon (B2)	Front
PK001	VOLKSWAGEN	98-Sept'02	Polo Playa Hatch & Classic Sedan (mk 3 6N) EXC sport susp	Front
PK001	VOLKSWAGEN	78-92	Golf I / Jetta I & Citi INC Fox, Citi, ShuttleTrippa & Cabriolet	Front
PK001	VOLKSWAGEN	93-10	Citi - EXC Sonic, Life, VeloCiti & Rox (Sealed Strut)	Front
PK001	VOLKSWAGEN	98-10	Citi - Sonic, Life & VeloCiti Slight OE lowering EXC Rox - shorter rear)	Front
PK001	VOLKSWAGEN	85-93	Golf II & Jetta II	Front
PK001	VOLKSWAGEN	92-94	Golf III & Jetta III EXC VR6)	Front
PK001	VOLKSWAGEN	93-'04	Golf III & IV Cabriolet EXC 16" wheels)	Front
PK001	VOLKSWAGEN	95-99	Golf III & Jetta III INC Gti & Cti (EXC VR6)	Front
PK001	VOLKSWAGEN	93-99	Golf III & Jetta III VR6	Front
PK004	CHEVROLET	10/03-05	Vivante MPV (Was Tacuma)	Front
PK004	DAEWOO	01-'03	Tacuma MPV	Front
PK004	OPEL	80-Mid 85	(S/W) Kadett S/Wagon FWD (D)	Front
PK004	DAEWOO	95- 98	Cielo	Front
PK004	DAEWOO	96- 98	Espero	Front
PK004	DAEWOO	98-'03	Lanos T100	Front
PK004	DAEWOO	99-03	Matiz hatch M100	Front
PK004	OPEL	92- 98	Calibra 2.0 16v & 2.5 V6 EXC Turbo)	Front
PK004	OPEL	96-02	Corsa Hatch & Notch (sedan) INC Corsa LITE & Lite Sport (B)	Front
PK004	OPEL	02-15	Corsa LITE & Lite Sport - old shape Corsa hatch (B)	Front
PK004	OPEL	96-Late 04	Corsa LDV	Front
PK004	OPEL	98-02	Corsa Pronto Panel Van	Front
PK004	OPEL	80-Mid 85	 Kadett FWD (D)	Front
PK004	OPEL	Mid 85-88	  Kadett & Monza Sedan "T car" (E) INC Gsi & Cabriolet	Front
PK004	OPEL	89-92	  Kadett & Monza Sedan INC Cub & Gsi 2.0 (F.W.D) "T car" (E)	Front
PK004	VOLVO	94- 96	850 Sedan & S/Wagon EXC Lowered and Nivomat self leveling suspension)	Front
PK004	VOLVO	97-'00	S70 Sedan EXC (lowered & Nivomat leveling suspension)	Front
PK004	VOLVO	97- Feb'00	V70 S/Wagon Gen1 EXC Elec Four-C & Nivomat rears)	Front
PK004	VOLVO	97-05	  C70 Coupe & Cabrio	Front
PK004	MINI	01-06	Mini One, Cooper, Cooper S, One D (R50, R52, R53 Mk I)	Front
PK004	MINI	07-13	Mini One, Cooper, Cooper D, Cooper S, One D (R56,R57 Mk II) INC cabriolet (R57) & sport	Front
PK004	MINI	08-14	Mini Clubman S/Wagon INC sport (R55) mkl	Front

Key









*	See important installation information on inside front cover
!	Excluding self-leveling suspension
"..."	Special order - phone 010 900 1850. 6-12 week waiting period

~	Imported
#	Internal bump stop
⊕	Steering damper

- It is recommended that all new shock absorbers are fitted in pairs
- Do not mix gas and non-gas units on the same axle
- **Bold** part numbers indicate heavy-duty shocks
- Underlined part numbers indicate parts not immediately available
- *Italic* part numbers followed by > indicate parts to be discontinued

Protection kits

Part number [numerical listing]

Part number	Make	Year	Application	Position
PK005	CHEVROLET	78-92	 Rekord & Commodore Sedan	Front
PK005	CHEVROLET	78-89	[S/W] Rekord & Commodore S/Wagon	Front
PK005	CHEVROLET	79-82	Senator	Front
PK005	OPEL	93- Oct'99	  Kadett & Astra [Exc] S/W (F)	Front
PK005	OPEL	93- Oct'99	[S/W] Astra Estate S/Wagon (F)	Front
PK005	OPEL	78-91	 Rekord & Commodore Sedan	Front
PK005	OPEL	78-91	[S/W] Rekord & Commodore S/Wagon	Front
PK005	OPEL	91-95	 Rekord 4 Cylinder (Solid Axle)	Front
PK005	OPEL	91-95	 Rekord 6 Cylinder (I.R.S.)	Front
PK005	OPEL	79-86	Senator	Front
PK006	MAZDA	Mid 99-03	626 sedan (GF) [assembled in Zimbabwe]	Rear
PK006	CITROEN	03-April'08	Berlingo Multispace MPV & P/Van	Front
PK006	CITROEN	01-05	Xsara II	Front
PK006	CITROEN	01-07	Xsara Picasso MPV	Front
PK006	PEUGEOT	98-02	306 Hatch, 1.6 Sedan and S/Wagon	Front
PK006	PEUGEOT	93-97	 306 CC Cabrio	Front
PK006	PEUGEOT	93-95	405 Sedan & S/Wagon [Exc] Sri, Sti, Mi16 & T16)	Front
PK006	PEUGEOT	99-Nov'02	Partner Grand Raid MPV 2.0 Hdi (DW10TD) gen 1 (600kg payload) (5F)	Front
PK006	PEUGEOT	Nov'02-08	Partner Grand Raid MPV 1.9D (DW8B) & 2.0 Hdi (DW10TD) gen 1 (600kg payload) (5F)	Front
PK006	PEUGEOT	99-11/02	Partner Panel Van 1.9D gen 1 (800kg payload)	Front
PK006	PEUGEOT	11/02-08	Partner Panel Van 1.9D gen 1 (800kg payload)	Front
PK006	CITROEN	96-02	Berlingo Multispace MPV & P/Van	Front
PK006	MERCEDES-BENZ	02-04	Vito Minibus & Van 112 & 113 FWD (W638 Gen 1)	Front
PK007	ALFA ROMEO	90- 98	164 [Exc] elec. susp./ leveling systems)	Rear
PK008	FORD	Mid 83-93	  Sierra & Sapphire Sedan [Exc] XR8 & S/W	Front
PK008	HYUNDAI	94-May'97	 Accent I (X3)	Rear
PK011	VOLVO	94-96	960 Sedan & S/Wagon (Leaf spring susp) [Exc] coil rear suspension	Front
PK012	BMW	74-75	518, 520 (E12)	Front
PK012	BMW	74-76	525, 528 (E12) – [Exc] 518, 520 '76 model only	Front
PK012	BMW	77-Mid 85	518, 520, 525, 528 (E12)	Front
PK012	BMW	76 - 6/78	630CS, 633CSi, 635CSi (E24)	Front
PK012	BMW	6/78 - 5/82	628CSi, 630CSi, 633CSi, 635CSi (E24)	Front
PK012	BMW	78-87	728, 730, 733, 735 (E23)	Front
PK012	BMW	84-86	745i (E23)	Front
PK012	BMW	86-88	730, 735 (E32) [Exc] elec suspension & M Tech)	Front
PK012	BMW	89-90	730, 735 (E32) [Exc] elec suspension & M Tech)	Front
PK012	BMW	91-94	730, 735 & 740 (E32) [Exc] 750 & elec suspension & M Tech)	Front
PK012	BMW	End 04-Oct'11	1 Series 116i, 118i, 120i, 130i & 120d [Exc] Sport Susp, xDrive & 135i Coupe)	Front
PK012	BMW	End 04-Oct'11	1 Series 116i, 118i, 120i, 130i, 135i & 120d Sport Susp [Exc] std 135i Coupe [Exc] xDrive)	Front
PK012	BMW	84-91	 318i, 320i, 323i & 325i (E30) [Exc] iS & cabrio (51mm strut OD)	Front
PK012	BMW	87-91	  325iS Evo I & II std and E30 Cabriolet (51mm strut OD)	Front

Key

*	See important installation information on inside front cover
!	Excluding self-levelling suspension
"..."	Special order – phone 010 900 1850. 6-12 week waiting period

~	Imported
#	Internal bump stop
⊕	Steering damper

- It is recommended that all new shock absorbers are fitted in pairs
- Do not mix gas and non-gas units on the same axle
- **Bold** part numbers indicate heavy-duty shocks
- Underlined part numbers indicate parts not immediately available
- *Italic* part numbers followed by > indicate parts to be discontinued

Protection kits

Part number [numerical listing]

Part number	Make	Year	Application	Position
PK012	BMW	91-99	316i, 318i, 318is, 318tds, 320i, 323i, 325i, 325td, 325tds, 328i Imported & Local Strut. EXCL Cabrio. EXCL M. Tech. (E36)	Front
PK012	BMW	91-92	320i, 325i & 325td Imported EXCL M. Tech. (E36)	Front
PK012	BMW	90-99	E36 M Tech (BMW Motorsport)	Front
PK012	BMW	90-99	M3 (E36)	Front
PK012	BMW	93-99	 M3 (E36)	Front
PK012	BMW	93-99	 323i, 325i & 328i Cabriolet (EXCL M Tech) (E36)	Front
PK012	BMW	99 - Sept'01	318i & 320d (E46) EXCL M3, cabrio, coupe, & sport susp)	Front
PK012	BMW	99 - Sept'01	320i, 323i, 325i & 328i (E46) EXCL M3, cabrio, coupe & sport susp)	Front
PK012	BMW	99- April'01	330i & 330d (E46) EXCL M3, cabrio, coupe & sport)	Front
PK012	BMW	Sept'01- Feb'05	318i (E46) EXCL Compact, M3, cabrio, coupe, sport susp & S/W)	Front
PK012	BMW	Sept'01- Feb'05	320i, 320d, 325i (E46) EXCL Compact, M3, cabrio, coupe & sport susp)	Front
PK012	BMW	April'01- Feb'05	330i & 330d (E46) EXCL 325ti compact EXCL M3, cabrio, coupe, sport susp & S/W)	Front
PK012	BMW	98-05	E46 – Sport Pack II for BMW OE Sport Susp EXCL Ci	Front
PK012	BMW	Nov'01-05	318ti Compact (E46) EXCL Sport susp	Front
PK012	BMW	Nov'01-05	325ti Compact (E46) EXCL Sport susp	Front
PK012	BMW	00- 05	318i Touring (E46) EXCL Sport susp)	Front
PK012	BMW	00-05	320i, 325i Touring (E46) EXCL Sport susp)	Front
PK012	BMW	00-06	 330Ci Cabriolet EXCL Sport Pac II & M3) (E46)	Front
PK012	BMW	99-Sept'01	 325Ci, 330Ci Coupe EXCL Sport Pac II & M3) (E46)	Front
PK012	BMW	Oct'01-06	 325Ci, 330 Ci Coupe EXCL Sport Pac II & M3) (E46)	Front
PK012	BMW	00-06	 325Ci, 330 Ci Coupe Sport Pac II (EXCL M3) (E46)	Front
PK012	BMW	March'05-12	3 series (E90 & E91) 320i, 320d, 323i, 325i, 330d, 330i & 335i (EXCL Sport susp, M3, Cabrio & Coupe)	Front
PK012	BMW	March'05-12	3 series Sport susp, (E90 & E91) 320i, 320d, 323i, 325i, 330d, 330i & 335i (EXCL M3, Cabrio & Coupe)	Front
PK012	BMW	07-12	 330i, 335i Cabriolet (EXCL M3, Coupe) (E93)	Front
PK012	BMW	07 - 12	 320i, 325i, 335i Coupe (EXCL M3, Cabrio) (E92)	Front
PK012	BMW	Mid 85-89	518, 520, 525, 525e, 528 & 535e (E28) EXCL M Tech)	Front
PK012	BMW	88-95	5 Series (E34) EXCL Sport Susp, M Tech & M5) Note: See the INFO column for front shock selection details. Check OE #'s	Front
PK012	BMW	Mid 90 -95	5 Series (E34) Std. & Sport Susp (EXCL M Tech & M5) Note: See the INFO column for front shock selection details. Check OE numbers	Front
PK012	BMW	6/82 - '90	628CSi, 635CSi (E24) EXCL elec suspension)	Front
PK012	BMW	94-02	728i, 730d, 735i, 740i & 750i & Limo (E38) EXCL Air Susp. & elec susp)	Front
PK012	BMW	97-'03	Z3 1.8, 1.9, 2.8 & 3.0 (E36) EXCL M-tech & M Coupe	Front
PK012	BMW	04-09	Z4 2.0, 2.5 & 3.0 (EXCL M-Tech 3.2M & Sport susp)	Front
PK012	SEAT	06-08	Ibiza Hatch & Sedan (EXCL sport susp)	Front
PK012	VOLKSWAGEN	Oct'02-Jan'10	Polo Hatch & Classic Sedan EXCL CrossPolo (mk 4 9N3)	Front
PK013	FIAT	90-'09	Uno (EXCL raised body "Way" version from Brazil)	Front
PK013 (Bump rubber only)	FORD	83-86	Bantam LDV	Front
PK013 (Bump rubber only)	FORD	87-93	Bantam LDV	Front
PK013 (Bump rubber only)	FORD	Mid 81-86	 Escort FWD	Front
PK014	AUDI	77-83	100, 200	Rear
PK015	AUDI	75-Mid 81	80 Sedan & S/Wagon	Rear

Key







*	See important installation information on inside front cover
!	Excluding self-levelling suspension
...	Special order – phone 010 900 1850. 6-12 week waiting period

~	Imported
#	Internal bump stop
⊕	Steering damper

- It is recommended that all new shock absorbers are fitted in pairs
- Do not mix gas and non-gas units on the same axle
- **Bold** part numbers indicate heavy-duty shocks
- Underlined part numbers indicate parts not immediately available
- *Italic* part numbers followed by > indicate parts to be discontinued

Protection kits

Part number [numerical listing]

Part number	Make	Year	Application	Position
PK015	VOLKSWAGEN	78-92	Golf I / Jetta I & Citi INC1 Fox, CTi, ShuttleTrippa & Cabriolet	Rear
PK015	VOLKSWAGEN	93-10	CITI – EXC1 Sonic, Life, VeloCiti & Rox (Sealed Strut)	Rear
PK015	VOLKSWAGEN	98-10	Citi – Sonic, Life & VeloCiti Slight OE lowering (EXC1 Rox – shorter rear)	Rear
PK016	AUDI	95- Jan'99	 A4 Sedan (EXC1 Quattro, Sport) 8D, B5	Rear
PK016	AUDI	96- Jan'99	 A4 Avant (EXC1 Quattro, Sport) 8D, B5	Rear
PK016	AUDI	Feb'99-Nov'00	 A4 Sedan (EXC1 Sport susp, Avant S/W & Quattro) B5, 8D	Rear
PK017	VOLKSWAGEN	81-87	  Passat Sedan & S/Wagon (B2)	Rear
PK017	VOLKSWAGEN	85-93	Golf II & Jetta II	Rear
PK017	VOLKSWAGEN	92-94	Golf III & Jetta III (EXC1 VR6)	Rear
PK017	VOLKSWAGEN	95-99	Golf III & Jetta III INC1 Gti & Cli (EXC1 VR6)	Rear
PK017	VOLKSWAGEN	93-99	Golf III & Jetta III VR6	Rear
PK017	VOLKSWAGEN	93-'04	Golf III & IV Cabriolet (EXC1 16" wheels)	Rear
PK018	FORD	85-91	Laser & Meteor All (KC, KE)	Rear
PK018	FORD	92 - 02	Laser & Meteor All INC1 Tracer (KF, KH)	Rear
PK018	MAZDA	Mid 81-85	323 F.W.D (BD 5th gen)	Rear
PK018	MAZDA	85-91	323 (INC1 EGi) F.W.D (BF 6th gen)	Rear
PK018	MAZDA	92-'03	323 All INC1 Midge & Sting (BF 6th gen)	Rear
PK018	ALFA ROMEO	09-18	MiTo hatch 1.4, 1.4T, 1.6JTD (EXC1 1.4T QV sport, 1.8T GTA & Elec susp)	Rear
PK018	FORD	95- 99	 Escort	Rear
PK018	FORD	97- Mid 99	Fiesta (EXC1 Power steering) Mk4 (JA, JB)	Rear
PK018	FORD	Mid 99 -03	Fiesta (EXC1 RSi) Mk4 facelift (JA, JB)	Rear
PK018	CHEVROLET	11-18	Sonic sedan & hatch 1.4 & 1.6 (T300) EXC1 RS 1.4 Turbo	Rear
PK018	FIAT	March'12-16	Punto 1.2, 1.3 JTD, 1.4 Hatch (199) INC1 sport susp (EXC1 turbo)	Rear
PK018	FIAT	06-16	Grand Punto 1.2, 1.3, 1.4 & 1.9 (199)	Rear
PK018	MAZDA	97- 99	121 Soho gen 4 (BE, JA, JB)	Rear
PK018	MAZDA	99 - 06	121 Soho gen 4 facelift (BE, JA, JB)	Rear
PK018	OPEL	Nov'07-Oct'15	Corsa Hatch (EXC1 Lite, OPC and Sport) (D)	Rear
PK018	FORD	00-06	Ikon sedan All	Rear
PK019	BMW	74-75	518, 520 (E12)	Rear
PK019	BMW	74-76	525, 528 (E12) – INC1 518, 520 '76 model only	Rear
PK019	BMW	77-Mid 85	518, 520, 525, 528 (E12)	Rear
PK019	BMW	Mid 85-89	518, 520, 525, 525e, 528 & 535e (E28) (EXC1 M Tech)	Rear
PK019	BMW	76 - 6/78	630CS, 633CSi, 635CSi (E24)	Rear
PK019	BMW	6/78 - 5/82	628CSi, 630CSi, 633CSi, 635CSi (E24)	Rear
PK019	BMW	6/82 - '90	628CSi, 635CSi (E24) (EXC1 elec suspension)	Rear
PK022	FORD	Dec'02-11	Bantam LDV	Front
PK022	FORD	95- 99	 Escort	Front
PK022	FORD	95- 99	(S/W) Escort S/Wagon	Front
PK022	FORD	Mid 99 -03	Fiesta (EXC1 RSi) Mk4 facelift (JA, JB)	Front
PK022	FORD	Mid 99 -03	 Fiesta 3 door 1.6 RSi & ST sport with power steering Mk4 facelift (JA, JB)	Front
PK022	FORD	97- Mid 99	Fiesta (EXC1 Power steering) Mk4 (JA, JB)	Front

Key

*	See important installation information on inside front cover
!	Excluding self-levelling suspension
"..."	Special order – phone 010 900 1850. 6-12 week waiting period

~	Imported
#	Internal bump stop
⊕	Steering damper

- It is recommended that all new shock absorbers are fitted in pairs
- Do not mix gas and non-gas units on the same axle
- **Bold** part numbers indicate heavy-duty shocks
- Underlined part numbers indicate parts not immediately available
- *Italic* part numbers followed by > indicate parts to be discontinued

Protection kits

Part number [numerical listing]

Part number	Make	Year	Application	Position
PK022	MAZDA	97-99	121 Soho gen 4 (BE, JA, JB)	Front
PK022	MAZDA	99-06	121 Soho gen 4 facelift (BE, JA, JB)	Front
PK022	FORD	00-06	Ikon sedan ALL	Front
PK023	ALFA ROMEO	00-06	156 Sportwagon (EXC GTA / elec susp / self leveling rears)	Rear
PK023	TOYOTA	84-88	  Corolla sedan, Avante & Conquest F.W.D – EXC Twin Cam (E80)	Rear
PK023	TOYOTA	Mid 85-88	  Corolla sedan, Avante & Conquest F.W.D – Narrow head Twin Cam (E80)	Rear
PK023	ALFA ROMEO	97-05	156 ALL (EXC GTA, Sport susp)	Rear
PK023	ALFA ROMEO	97-05	156 GTA & Sport Susp (EXC 3.2 GTA)	Rear
PK023	ALFA ROMEO	June'01-10	147 1.6TS, 1.9JTD & 2.0TS hatch	Rear
PK023	TOYOTA	89-96	  Corolla & Conquest EXC Twin Cam & 1800 F.W.D P140 (EE90, AE92, CE90)	Rear
PK023	TOYOTA	96-Oct'02	 Corolla Sedan P160 gen 7 EXC Rsi & Rxi (E100, AE101)	Rear
PK023	TOYOTA	96-June'06	 Conquest / Tazz (EE90, AE92)	Rear
PK023	ALFA ROMEO	05-10	2.0 & 1.9JTD & 3.2 V6 GTA	Rear
PK023	TOYOTA	96-June'06	Tazz	Rear
PK023	TOYOTA	98-06	Conquest Carri Panel Van	Rear
PK024	PEUGEOT	80-85	505 Sedan (Local Strut)	Front
PK024	ALFA ROMEO	94-97	145 & 146 1.3, 1.6, 1.7 16v	Front
PK024	ALFA ROMEO	94- June 01	145 & 146 1.4TS, 1.6TS, 1.8TS, 1.9TDS & 2.0 TS	Front
PK024	ALFA ROMEO	91-97	155 (EXC 2500 V6, 2.5TD, 2.0 Turbo AWD, elec susp)	Front
PK024	ALFA ROMEO	91-97	155 2500 V6, 2.5TD (EXC elec susp)	Front
PK026 (Bump rubbers only)	TOYOTA	84-88	  Corolla sedan, Avante & Conquest F.W.D – EXC Twin Cam (E80)	Front
PK026 (Bump rubbers only)	TOYOTA	Mid 85-88	  Corolla sedan, Avante & Conquest F.W.D – Narrow head Twin Cam (E80)	Front
PK026 (Bump rubbers only)	TOYOTA	96-June'06	Tazz	Front
PK026 (Bump rubbers only)	TOYOTA	98-06	Conquest Carri Panel Van	Front
PK026 (Bump rubbers only)	TOYOTA	89-96	  Corolla & Conquest EXC Twin Cam & 1800 F.W.D P140 (EE90, AE92, CE90)	Front
PK026 (Bump rubbers only)	TOYOTA	96-Oct'02	 Corolla Sedan P160 gen 7 EXC Rsi & Rxi (E100, AE101)	Front
PK026 (Bump rubbers only)	TOYOTA	96-June'06	 Conquest / Tazz (EE90, AE92)	Front
PK029 (Boots only)	RENAULT	95-'02	  Megane Hatch & '96-'03 Classic Sedan (EXC 2.0 16v)	Front
PK029 (Boots only)	RENAULT	96-May'04	Megane Coupe (EXC 2.0 16v)	Front
PK029 (Boots only)	RENAULT	97 - May'04	Megane Cabriolet (EXC 2.0 16v)	Front
PK029 (Boots only)	RENAULT	June'98-Feb'04	Scenic 1.6 Automatic, 1.9dCi, 2.0 (EXC RX4)	Front
PK029 (Boots only)	RENAULT	99-01	Laguna Sedan (B56 / K56) Check front mounting information for correct strut OE#'s 7700830491 or 7700830492 = 11655	Front
PK029 (Boots only)	RENAULT	95-00	Laguna S/Wagon (B56 / K56)	Front
PK029 (Boots only)	RENAULT	Mid 83-86	R9 & R11 All	Front
PK029 (Boots only)	RENAULT	96-'02	Espace (J66 / P52) + Grand Espace (D66) MPV EXC air susp	Front
PK029 (Boots only)	RENAULT	99-01	Laguna Sedan (B56 / K56) Check front mounting information for correct strut Shock OE#'s 7700830490 = 11743	Front
PK029 (Boots only)	RENAULT	96-'00	Safrane	Front
PK029 (Boots only)	RENAULT	96-Feb'04	Scenic 1.4 & 1.6 Manual (EXC RX4)	Front
PK029 (Boots only)	RENAULT	96- June'98	Scenic 1.6 Automatic, 1.9dCi, 2.0 (EXC RX4)	Front
PK030 >	MAZDA	83-93	626 Sedan (EXC Coupe) RSA mnf model	Rear

Key



*	See important installation information on inside front cover
!	Excluding self-leveling suspension
"..."	Special order – phone 010 900 1850. 6-12 week waiting period

~	Imported
#	Internal bump stop
⊕	Steering damper

- It is recommended that all new shock absorbers are fitted in pairs
- Do not mix gas and non-gas units on the same axle
- **Bold** part numbers indicate heavy-duty shocks
- Underlined part numbers indicate parts not immediately available
- *Italic* part numbers followed by > indicate parts to be discontinued

Protection kits

Part number [numerical listing]

Part number	Make	Year	Application	Position
PK034	MERCEDES-BENZ	86-95	W124 EXCI E420, E500 INCL all CE models C124 coupes, EXCI Self leveling susp. S/W, Sportline & V124 limo (W124)	Front
PK034	MERCEDES-BENZ	86-95	S124 S/Wagon 230TE & 300TE EXCI sport susp	Front
PK034	MERCEDES-BENZ	83-94	190E INCL Sportline (201 Series)	Front
PK036	NISSAN	92- 7/01	Sentra 140 (B13 Sunny)	Front
PK036	NISSAN	92- 7/01	Sentra & Sabre 160 (B13 Sunny)	Front
PK036	NISSAN	92- 7/01	Sentra & Sabre 200 EXCI ABS (B13 Sunny)	Front
PK038	AUDI	83-94	400, 500 (EXCI Quattro, sport susp & S4)	Front
PK038	AUDI	91-94	500 Quattro sedan and Avant S/W std susp (EXCI S4 & sport susp)	Front
PK038	AUDI	94-July'97	A6 Sedan & Avant (EXCI Quattro, Sport susp., & S6)	Front
PK041 > (Boots only)	MAZDA	83-93	626 Sedan (INCL Coupe) RSA mnf model	Front
PK044	VOLVO	95- May'99	S40 Sedan & V40 S/W (EXCI Sport & T4)	Front
PK044	VOLVO	95- May'99	S40 Sedan & V40 S/W T4 and Sportline	Front
PK044	VOLVO	June'99-April'00	S40 Sedan & V40 S/W INCL T4 (EXCI Sport)	Front
PK047	AUDI	75-Mid 81	80 Sedan & S/Wagon	Front
PK048	VOLKSWAGEN	98-Sept'02	Polo Playa Hatch & Classic Sedan (mk 3 6N) EXCI sport susp	Rear
PK054 > PK004	CHERY	08-on	QQ3 (S11) 0.8, 1.1	Front
PK054 > PK004	CHEVROLET	03-05	Spark (M100, M150)	Front
PK056	FIAT	01-06	Seicento 1100	Front
PK057	VOLVO	97- 98	S90 Sedan gen 1 EXCI elec or self level susp	Front
PK058	FORD	94-Nov'02	Bantam LDV	Front
PK058	FORD	85-91	Laser & Meteor All (KC, KE)	Front
PK058	FORD	92 - 02	Laser & Meteor All INCL Tracer (KF, KH)	Front
PK058	MAZDA	Mid 81-85	323 F.W.D (BD 5th gen)	Front
PK058	MAZDA	85-91	323 (INCL EGi) F.W.D (BF 6th gen)	Front
PK058	MAZDA	92-'03	323 All INCL Midge & Sting (BF 6th gen)	Front
PK058	MAZDA	94-10	Rustler LDV	Front
PK058	NISSAN	88-91	Sentra Sedan & Coupe INCL Twincam (B12 Sunny)	Rear
PK059	FORD	98-Sept'01	 Mondeo 1.8 ,2.0 & 2.5 Si sedan	Front
PK059	FORD	98- Sept'01	(S/W) Mondeo 2.0 S/Wagon	Front
PK060	VOLKSWAGEN	98-07	Sharan MPV (7M8, 7M9, 7M6)	Front
PK061	FORD	98-Sept'01	 Mondeo 1.8 ,2.0 & 2.5 Si sedan	Rear
PK062	NISSAN	Sept'98-02	Primera 1.6 Si ; 2.0 Si & Gsi (EXCI 2.0 Sti)	Front
PK062	NISSAN	Sept'98-02	Primera 2.0 Sti	Front
PK064	OPEL	01-06	Omega 2.2Dti, 2.5 all, 2.6, 3.0, 3.2 (EXCI S/Wagon) (V94)	Front
PK066	RENAULT	99-13	Clio 1.2 INCL Va va voom (EXCI 1.2 16v, 1.4 & 1.6, 2.0 & 3.0 V6)	Front
PK066	RENAULT	99-06	Clio 1.2 16v, 1.4, 1.5dCi & 1.6 (EXCI Sport 1.6, 2.0 & 3.0)	Front
PK066	RENAULT	99-06	Clio 1.6 16v Sport (EXCI 2.0 16v Sport & 3.0 V6 mid engine)	Front
PK066	RENAULT	June'04-08 (Multix) '01-09 (Express)	Kangoo 1 Multix 1.4 MPV people carrier (580kg payload, 2 rear torsion bars), and Kangoo 1 Express minivan 1.4 & 1.5dCi (750kg payload, 4 rear torsion bars) (EXCI 4x4)	Front
PK066	RENAULT	08-13	Twingo hatch 1.2, 1.5TD. Gen 2, EXCI RS Sport (CNO)	Front
PK074	FIAT	02-June'06	 Ducato 10, 14 Van 2.3JTD, 2.8JTD - 1.0 ton & 1.5 ton Gen 2	Front
PK074	PEUGEOT	99-06	Boxer Van 1.4 ton SWB gen 2	Front

Key

*	See important installation information on inside front cover
!	Excluding self-leveling suspension
"..."	Special order - phone 010 900 1850. 6-12 week waiting period

~	Imported
#	Internal bump stop
⊕	Steering damper

- It is recommended that all new shock absorbers are fitted in pairs
- Do not mix gas and non-gas units on the same axle
- **Bold** part numbers indicate heavy-duty shocks
- Underlined part numbers indicate parts not immediately available
- *Italic* part numbers followed by > indicate parts to be discontinued

Protection kits

Part number [numerical listing]

Part number	Make	Year	Application	Position
PK074	PEUGEOT	99-06	Boxer Van 1.8 ton LWB gen 2	Front
PK075	OPEL	01-05	Zafira 1.6, 1.8, 1.9CDTi, 2.2 MPV (EXC 2.0 turbo & OPC) (A)	Front
PK075 (Bump rubber only)	OPEL	Nov'99-Sept'04	Astra hatch & Classic sedan (G) (EXC OPC & S/W)	Front
PK075 (Bump rubber only)	OPEL	01-Sept'04	Astra Caravan S/Wagon (G)	Front
PK075 (Bump rubber only)	OPEL	01-06	Astra Coupe & Cabriolet (G)	Front
PK076	AUDI	11-May 18	A1 Gen 1 (8X) EXC Sport susp (122 PS)	Front
PK076	AUDI	11-May '18	A1 Gen 1 (8X) Sport susp & 1.4 TFSi (185 PS)	Front
PK076	AUDI	98-April'03	A3 1.8 & 1.8T turbo, 1.9TDi (EXC Sport Susp, Quattro & S3)	Front
PK076	AUDI	98-April'03	A3 Sport Susp (EXC Quattro)	Front
PK076	AUDI	00-06	TT 1.8 Turbo Coupe & Roadster/Cabriolet (8N) EXC Sport Susp & 3.2 V6 Quattro (8N)	Front
PK076	VOLKSWAGEN	Feb'10-Jan '18	 Polo Hatch, EXC Vivo, Sedan & Cross (mk 5 model, 6R, 6C)	Front
PK076	VOLKSWAGEN	Feb'10-19	 Polo Sedan, EXC Vivo, Gti, hatch (mk 5 model, 6V2)	Front
PK076	VOLKSWAGEN	Feb'10-Feb '18	  Polo VIVO (mk 4 9N3) EXC Maxx	Front
PK076	VOLKSWAGEN	March 18-on	 Polo VIVO (mk 5 model, 6R, 6C) EXC Maxx	Front
PK076	VOLKSWAGEN	10/02-1/10	CrossPolo & Vivo Maxx EXC Sport Susp (mk 4 9N3)	Front
PK076	VOLKSWAGEN	11-18	CrossPolo & Vivo Maxx EXC Sport Susp (mk 5 6R)	Front
PK076	VOLKSWAGEN	99-04 till 2/06	(Jetta) Golf IV & Jetta IV 1.6 only (EXC Estate S/W) 20mm rod	Front
PK076	VOLKSWAGEN	99-04 till 2/06	(Jetta) Golf IV & Jetta IV 1.8, Gti Turbo, 1.9 Tdi, 2.0, 2.3 V5 (EXC Estate S/W & 1.6) 22mm rod	Front
PK076	VOLKSWAGEN	99-05	Golf IV 1.6 Estate S/Wagon	Front
PK076	VOLKSWAGEN	00-05	Golf IV 1.9 Tdi Estate S/Wagon	Front
PK076	VOLKSWAGEN	99-Oct'12	New Beetle (Type 2)	Front
PK078 EXC Quattro	AUDI	00-06	TT 1.8 Turbo Coupe & Roadster/Cabriolet (8N) EXC Sport Susp & 3.2 V6 Quattro (8N)	Rear
PK078	VOLKSWAGEN	07-15	Eos Cabriolet	Rear
PK078	VOLKSWAGEN	99-05	Golf IV 1.6 Estate S/Wagon	Rear
PK078	VOLKSWAGEN	00-05	Golf IV 1.9 Tdi Estate S/Wagon	Rear
PK078	AUDI	11-May 18	A1 Gen 1 (8X) EXC Sport susp (122 PS)	Rear
PK078	AUDI	11-May '18	A1 Gen 1 (8X) Sport susp & 1.4 TFSi (185 PS)	Rear
PK078	AUDI	98-April'03	A3 1.8 & 1.8T turbo, 1.9TDi (EXC Sport Susp, Quattro & S3)	Rear
PK078	AUDI	98-April'03	A3 Sport Susp (EXC Quattro)	Rear
PK078	CHEVROLET	03-11	Aveo gen one & two (T200 & T250 facelift)	Rear
PK078	FORD	04-Oct'08	 Fiesta Sedan & Hatch Mk 5 JH, JD EXC 2.0ST (EXC 2.5 ST or RS)	Rear
PK078	FORD	Nov'08-Oct '12	 Fiesta Sedan & Hatch Mk 6 CB1, CCN (EXC 1.6 ST)	Rear
PK078	FORD	Nov 12-17	 Fiesta Sedan & Hatch Mk 6 facelift (EXC ST)	Rear
PK078	FORD	17-22	 Fiesta Sedan & Hatch Mk 7 HJ, HF	Rear
PK078	FORD	10-Nov 15	Figo Hatch 1.4 gen 1	Rear
PK078	FORD	Dec 15-18	Figo Hatch & sedan 1.5 gen 2 (EXC Freestyle Cross)	Rear
PK078	FORD	18-21	Figo Hatch & sedan gen 3	Rear
PK078	VOLKSWAGEN	99-Oct'12	New Beetle (Type 2)	Rear
PK078	VOLKSWAGEN	99-04 till 2/06	(Jetta) Golf IV & Jetta IV 1.6 only (EXC Estate S/W) 20mm rod	Rear
PK078	VOLKSWAGEN	99-04 till 2/06	(Jetta) Golf IV & Jetta IV 1.8, Gti Turbo, 1.9 Tdi, 2.0, 2.3 V5 (EXC Estate S/W & 1.6) 22mm rod	Rear

Key











*	See important installation information on inside front cover
!	Excluding self-levelling suspension
...	Special order – phone 010 900 1850. 6-12 week waiting period

~	Imported
#	Internal bump stop
⊕	Steering damper

- It is recommended that all new shock absorbers are fitted in pairs
- Do not mix gas and non-gas units on the same axle
- **Bold** part numbers indicate heavy-duty shocks
- Underlined part numbers indicate parts not immediately available
- *Italic* part numbers followed by > indicate parts to be discontinued

Protection kits

Part number [numerical listing]

Part number	Make	Year	Application	Position
PK078	VOLKSWAGEN	Oct'02-Jan'10	Polo Hatch & Classic Sedan EXCL CrossPolo (mk 4 9N3)	Rear
PK078	VOLKSWAGEN	Feb'10-Jan '18	 Polo Hatch, EXCL Vivo, Sedan & Cross (mk 5 model, 6R, 6C)	Rear
PK078	VOLKSWAGEN	Feb'10-19	 Polo Sedan, EXCL Vivo, Gti, hatch (mk 5 model, 6V2)	Rear
PK078	VOLKSWAGEN	20 - on	 Polo 1.6 Sedan (mk 5 facelift)	Rear
PK078	VOLKSWAGEN	Feb'10-Feb '18	  Polo VIVO (mk 4 9N3) EXCL Maxx	Rear
PK078	VOLKSWAGEN	March 18-on	 Polo VIVO (mk 5 model, 6R, 6C) EXCL Maxx	Rear
PK078	VOLKSWAGEN	10/02-1/10	CrossPolo & Vivo Maxx EXCL Sport Susp (mk 4 9N3)	Rear
PK078	VOLKSWAGEN	11-18	CrossPolo & Vivo Maxx EXCL Sport Susp (mk 5 6R)	Rear
PK078	VOLKSWAGEN	04-Feb'09	Golf V Gti & R32 EXCL 4-motion AWD	Rear
PK078	VOLKSWAGEN	March'09-13	Golf VI Gti & R32 EXCL 4-motion AWD EXCL elec susp	Rear
PK078	VOLKSWAGEN	09-17	Scirocco EXCL elec, R or sport susp (137)	Rear
PK078	FORD	15-17	B-Max Mini MPV 1.0 (JK)	Rear
PK078	MAZDA	07-Feb'15	Mazda 2 (DE)	Rear
PK078	MAZDA	04-09	Mazda 3 gen 1 (BK) EXCL MPS, sport susp or AWD	Rear
PK078	MAZDA	01-04	Premacy (Cross border) Gen 1 	Rear
PK078	MAZDA	05-10	Mazda 5 MPV Gen 2 (CR19)	Rear
PK078	MAZDA	11-15	Mazda 5 MPV Gen 3 (CW)	Rear
PK078	FORD	07-15	Ikon sedan All	Rear
PK078 (round)	VOLKSWAGEN	04-Feb'09	Golf V (EXCL Gti, V5, R32 & Sport susp) 1K1. OE Strut leg bottom outer diam = 50mm	Rear
PK078 (round)	VOLKSWAGEN	March'09-13	Golf VI (EXCL Gti, V5, R32, AWD, Elec & Sport susp) OE Strut leg bottom outer diam = 50mm	Rear
PK078 (round)	VOLKSWAGEN	March'06-Sept'11	Jetta V (EXCL V5 & Sport susp) 1K2 (A5) Strut leg bottom outer diam = 50mm	Rear
PK078 (round)	VOLKSWAGEN	Oct'11-19	Jetta VI (EXCL V5 & Sport susp) 1B (A6) OE Strut leg bottom outer diam = 50mm	Rear
PK078 (round)	VOLKSWAGEN	Oct'11-19	Jetta VI (EXCL V5 & Sport susp) 1B (A6) OE Strut leg bottom outer diam = 55mm	Rear
PK080	SAAB	98-'02	  9.3 2.0 & 2.2TiD sedan & coupe EXCL Turbo	Front
PK080	SAAB	98-'02	 9.3 Convertible	Front
PK081	VOLVO	April'00-May'04	S40 Sedan & V40 S/W (EXCL Sport & T4)	Rear
PK081	VOLVO	April'00-Late'04	S40 Sedan & V40 S/W T4	Rear
PK081	VOLVO	95- May'99	S40 Sedan & V40 S/W (EXCL Sport & T4)	Rear
PK081	VOLVO	95- May'99	S40 Sedan & V40 S/W T4 and Sportline	Rear
PK081	VOLVO	June'99-April'00	S40 Sedan & V40 S/W (EXCL Sport & T4)	Rear
PK081	VOLVO	June'99-April'00	S40 Sedan & V40 S/W T4	Rear
PK082	ROVER	01-05	75 Sedan	Rear
PK084	FORD	03-Oct'04	Focus 1.6 Hatch & Sedan Mkl DAW (EXCL 2.0 & St170)	Front
PK084	FORD	00-Oct'04	Focus 2.0 & ST170 Hatch and Sedan Mkl	Front
PK085	PEUGEOT	00-12	206 1.4, 1.6 XS, 1.6 XT, 2.0 HDi & 20 Gti Hatch (2A/C)	Front
PK086	VOLVO	April'00-May'04	S40 Sedan & V40 S/W (EXCL Sport & T4)	Front
PK086	VOLVO	April'00-Late'04	S40 Sedan & V40 S/W T4	Front
PK087	PEUGEOT	95-'04	 406 Sedan (EXCL elec susp)	Front
PK087	PEUGEOT	96-'04	(S/W) 406 2.0 Estate S/Wagon (EXCL elec susp)	Front
PK087	PEUGEOT	97-Feb'06	 406 Coupe 3.0 (EXCL elec susp)	Front
PK088	AUDI	95- Jan'99	 A4 Sedan (EXCL Quattro, Sport) 8D, B5	Front

Key



*	See important installation information on inside front cover
!	Excluding self-levelling suspension
"..."	Special order - phone 010 900 1850. 6-12 week waiting period

~	Imported
#	Internal bump stop
⊕	Steering damper

- It is recommended that all new shock absorbers are fitted in pairs
- Do not mix gas and non-gas units on the same axle
- **Bold** part numbers indicate heavy-duty shocks
- Underlined part numbers indicate parts not immediately available
- *Italic* part numbers followed by > indicate parts to be discontinued

Protection kits

Part number [numerical listing]

Part number	Make	Year	Application	Position
PK088	AUDI	95- Jan'99	 A4 Quattro Sedan (EXCL Sport,) 8D, B5	Front
PK088	AUDI	96- Jan'99	 A4 Avant (EXCL Quattro, Sport) 8D, B5	Front
PK088	AUDI	Feb'99-Nov'00	 A4 Sedan (EXCL Sport susp, Avant S/W & Quattro) B5, 8D	Front
PK088	AUDI	Feb'99-Nov'00	 A4 Quattro & Sport Quattro (EXCL S4) B5, 8D	Front
PK088	AUDI	Feb'99-Nov'00	 A4 Avant (EXCL Sport susp, sedan & Quattro) B5, 8D	Front
PK088	AUDI	Feb'99-Nov'00	 A4 Avant Quattro (EXCL S4 & Sport suspension)	Front
PK088	AUDI	97-Jan'99	A6 Sedan & Avant (EXCL 2.7 Turbo, Quattro, Allroad & 4.2 V8) Only up to -> chassis No's 4B#X#070 000	Front
PK088	AUDI	97-April'00	A6 2.7 Turbo (EXCL Quattro, Allroad & 8 cyl) Up to -> chassis No's 4B#Y#200 000	Front
PK088	AUDI	97-Jan'99	A6 Quattro sedan & Avant S/W (EXCL 2.7 turbo, Allroad & 4.2 V8) Only up to -> chassis No's 4B#X#070 000	Front
PK088	AUDI	Feb'99-April'00	A6 Sedan & Avant S/W (EXCL Quattro, Allroad & 8cyl) INCL 2.7 Turbo From chassis No's 4B#X#070 000 -> 4B#Y#200 000	Front
PK088	AUDI	Feb'99-April'00	A6 Quattro sedan & Avant (EXCL 2.7 turbo, Allroad & 4.2 V8) From chassis No's 4B#X#070 000 -> 4B#Y#200 000	Front
PK088	AUDI	97-April'00	A6 2.7 Quattro Turbo, (EXCL Allroad 4WD & 4.2 V8) Up to -> chassis No's 4B#Y#200 000	Front
PK088	AUDI	May'00-March'04	A6 Sedan & Avant (EXCL Quattro, Allroad ,8cyl & Air Susp) From Ch# : 4B#1#000 001 -on	Front
PK088	AUDI	May'00-May'01	A6 Quattro sedan & Avant (EXCL Allroad & 4.2 V8)	Front
PK088	AUDI	June'01 - '04	A6 Quattro Sedan & Avant (EXCL All Road & 4.2 V8)	Front
PK088	VOLKSWAGEN	99-05	 Passat Sedan (EXCL S/W, Sport Susp & 4WD 4-Motion Syncro) (B5)	Front
PK088	VOLKSWAGEN	99-05	 Passat Sedan 2.3 V5 & 2.8 4WD 4-Motion Syncro (EXCL Sport Susp) (B5)	Front
PK089 > PK189	BMW	04-10	X3 (E83) 2.5, 3.0 & 2.0 d INCL Sport susp (EXCL elec susp)	Front
PK092	ALFA ROMEO	June'01-10	147 1.6TS, 1.9JTD & 2.0TS hatch	Front
PK092	ALFA ROMEO	97-05	156 ALL (EXCL GTA, Sport susp)	Front
PK092	ALFA ROMEO	97-05	156 GTA & Sport Susp (EXCL 3.2 GTA)	Front
PK092	ALFA ROMEO	00-06	156 Sportwagon (EXCL GTA / elec susp / self leveling rears)	Front
PK092	ALFA ROMEO	99-07	166 3.0 V6 & 3.2 V6 (INCL 2.0, 2.4, 2.5)	Front
PK092	ALFA ROMEO	05-10	2.0 & 1.9JTD & 3.2 V6 GTA	Front
PK093	FIAT	03-10	Stilo 1.6 Hatch	Front
PK093	FIAT	03-10	Stilo 1.8, 1.9 JTD Hatch	Front
PK093	FIAT	03-10	Stilo 2.4 Abarth Hatch	Front
PK093	FIAT	03-10	Stilo 1.6 Multi Wagon	Front
PK093	FIAT	03-10	Stilo 1.9 JTD Multi Wagon	Front
PK094 > PK078	AUDI	83-94	400, 500 (EXCL Quattro, sport susp & S4)	Rear
PK094 > PK078	AUDI	94-July'97	A6 Sedan & Avant (EXCL Quattro, Sport susp., & S6)	Rear
PK096	BMW	91-99	316i, 318i, 318is, 318tds, 320i, 323i, 325i, 325td, 325tds, 328i Imported & Local Strut. INCL Cabrio. (EXCL M. Tech). (E36)	Rear
PK096	BMW	91-92	320i, 325i & 325td Imported EXCL M. Tech. (E36)	Rear
PK096	BMW	90-99	E36 M Tech (BMW Motorsport)	Rear
PK096	BMW	90-99	M3 (E36)	Rear
PK096	BMW	93-99	 M3 (E36)	Rear
PK096	BMW	93-99	 323i, 325i & 328i Cabriolet (EXCL M Tech) (E36)	Rear
PK096	BMW	99 - Sept'01	318i & 320d (E46) (EXCL M3, cabrio, coupe, & sport susp)	Rear
PK096	BMW	99 - Sept'01	320i, 323i, 325i & 328i (E46) (EXCL M3, cabrio, coupe & sport susp)	Rear
PK096	BMW	99- April'01	330i & 330d (E46) (EXCL M3, cabrio, coupe & sport)	Rear
PK096	BMW	Sept'01- Feb'05	318i (E46) (EXCL Compact, M3, cabrio, coupe, sport susp & S/W)	Rear

Key

















*	See important installation information on inside front cover
!	Excluding self-leveling suspension
"..."	Special order - phone 010 900 1850. 6-12 week waiting period

~	Imported
#	Internal bump stop
⊕	Steering damper

- It is recommended that all new shock absorbers are fitted in pairs
- Do not mix gas and non-gas units on the same axle
- **Bold** part numbers indicate heavy-duty shocks
- Underlined part numbers indicate parts not immediately available
- *Italic* part numbers followed by > indicate parts to be discontinued

Protection kits

Part number [numerical listing]

Part number	Make	Year	Application	Position
PK096	BMW	Sept'01- Feb'05	320i, 320d, 325i (E46) [EXC] Compact, M3, cabrio, coupe & sport susp	Rear
PK096	BMW	April'01- Feb'05	330i & 330d (E46) [INC] 325ti compact [EXC] M3, cabrio, coupe ,sport susp & S/W	Rear
PK096	BMW	98-05	E46 – Sport Pack II for BMW OE Sport Susp [INC] Ci	Rear
PK096	BMW	Nov'01-05	318ti Compact (E46) [INC] Sport susp	Rear
PK096	BMW	Nov'01-05	325ti Compact (E46) [INC] Sport susp	Rear
PK096	BMW	00- 05	318i Touring (E46) [EXC] Sport susp	Rear
PK096	BMW	00-05	320i, 325i Touring (E46) [EXC] Sport susp	Rear
PK096	BMW	00-06	 330Ci Cabriolet [EXC] Sport Pac II & M3) (E46)	Rear
PK096	BMW	99-Sept'01	 325Ci, 330Ci Coupe [EXC] Sport Pac II & M3) (E46)	Rear
PK096	BMW	Oct'01-06	 325Ci, 330 Ci Coupe [EXC] Sport Pac II & M3) (E46)	Rear
PK096	BMW	00-06	 325Ci, 330 Ci Coupe Sport Pac II [EXC] M3) (E46)	Rear
PK096	BMW	97-'03	Z3 1.8, 1.9, 2.8 & 3.0 (E36) [EXC] M-tech & M Coupe	Rear
PK097	FORD	05-09	Ka 1.3 Hatch	Front
PK098	FORD	Sept'01-07	  Mondeo Sedan & Coupe [EXC] 18" Wheels & Sport susp	Front
PK098	FORD	Sept'01-07	(S/W) Mondeo S/Wagon	Front
PK098	HONDA	06-Aug '16	 Civic 1.8, 2.2 Hatch Mk8 + Mk9 (FN, FK) [EXC] Type R & Tourer S/W	Front
PK099	FORD	Sept'01-07	  Mondeo Sedan & Coupe [EXC] 18" Wheels & Sport susp	Rear
PK101	AUDI	02-08	 A4 Cabriolet [INC] Sport susp	Rear
PK101	AUDI	97-Jan'99	A6 Sedan & Avant [EXC] 2.7 Turbo, Quattro, Allroad & 4.2 V8) Only up to -> chassis No's 4B#X#070 000	Rear
PK101	AUDI	97-April'00	A6 2.7 Turbo [EXC] Quattro, Allroad & 8 cyl) Up to -> chassis No's 4B#Y#200 000	Rear
PK101	AUDI	Feb'99-April'00	A6 Sedan & Avant S/W [EXC] Quattro, Allroad & 8cyl) [INC] 2.7 Turbo From chassis No's 4B#X#070 000 -> 4B#Y#200 000	Rear
PK101	AUDI	May'00-March'04	A6 Sedan & Avant [EXC] Quattro, Allroad ,8cyl & Air Susp) From Ch# : 4B#1#000 001 -on	Rear
PK101	VOLKSWAGEN	99-05	 Passat Sedan [EXC] S/W, Sport Susp & 4WD 4-Motion Syncro) (B5)	Rear
PK101	VOLKSWAGEN	99-05	 Passat Sedan 2.3 V5 & 2.8 4WD 4-Motion Syncro [EXC] Sport Susp) (B5)	Rear
PK102	FORD	03-Oct'04	Focus 1.6 Hatch & Sedan Mkl DAW [EXC] 2.0 & St170)	Rear
PK102	FORD	00-Oct'04	Focus 2.0 & ST170 Hatch and Sedan Mkl	Rear
PK103	PEUGEOT	96-'04	(S/W) 406 2.0 Estate S/Wagon [EXC] elec susp)	Rear
PK103	PEUGEOT	95-'04	 406 Sedan [EXC] elec susp)	Rear
PK104	CITROEN	04-11	C2 1.1i, 1.4i, 1.6i [EXC] Sport Susp) (JM)	Front
PK104	CITROEN	02-May'06	C3 1.4i, 1.6i manual. [EXC] 1.6 auto, Hdi 80kw & 82kw 51mm OD strut base (FC / FN)	Front
PK104	CITROEN	02-May'06	C3 1.6i 16v auto & Hdi 80kw & 82kw [EXC] 46mm OD strut base. (FC / FN)	Front
PK104	CITROEN	June'06-Nov'09	C3 (facelift) 1.4, 1.6 (FC / FN)	Front
PK104	CITROEN	02-09	 C3 Pluriel & Enterprise models – Convertible (HB)	Front
PK105	VOLVO	00-10	S60 Sedan gen 1 [EXC] elec susp, Four-C, R 2.5 20V, AWD, Lowered & Nivomat Levelling Suspensions)	Front
PK105	VOLVO	98-July'06	S80 Sedan gen 1 [EXC] elec susp Four-C, Lowered & Nivomat Leveling Suspensions).	Front
PK105	VOLVO	00-07	V70 S/Wagon Gen 2 [EXC] elec susp, Four-C, R 2.5 20V, XC AWD, Lowered & Nivomat Levelling Suspensions)	Front
PK105	VOLVO	00-July'07	XC70 SUV AWD gen 2 [EXC] Four-C elec & self level suspension	Front
PK105	VOLVO	Aug'07-15	XC70 SUV AWD 3.0 T6. 3.2, 2.4 D5 gen 3 [EXC] elec susp	Front
PK106	HONDA	March'01-05	 Civic Vtec 4 door Sedan (ES) Mk7	Front
PK106	HONDA	March'01-05	 Civic Vtec 5 door hatch (EP, EU) Mk7 1.3, 1.4, 1.5, 1.6, 1.7i	Front
PK106	HONDA	March'01-05	Civic Vtec 5 door hatch (EP, EU) Mk7 1.3, 1.4, 1.5, 1.6, 1.7i 2.0 [EXC] Type R) & 1.7D	Front

Key

*	See important installation information on inside front cover
!	Excluding self-levelling suspension
"..."	Special order – phone 010 900 1850. 6-12 week waiting period

~	Imported
#	Internal bump stop
⊕	Steering damper

- It is recommended that all new shock absorbers are fitted in pairs
- Do not mix gas and non-gas units on the same axle
- **Bold** part numbers indicate heavy-duty shocks
- Underlined part numbers indicate parts not immediately available
- *Italic* part numbers followed by > indicate parts to be discontinued

Protection kits

Part number [numerical listing]

Part number	Make	Year	Application	Position
PK107 (Bump rubber only)	HONDA	March'01-05	 Civic Vtec 4 door Sedan (ES) Mk7	Rear
PK107 (Bump rubber only)	HONDA	March'01-05	 Civic Vtec 5 door hatch (EP, EU) Mk7 1.3, 1.4, 1.5, 1.6, 1.7i	Rear
PK107 (Bump rubber only)	HONDA	March'01-05	Civic Vtec 5 door hatch (EP, EU) Mk7 1.3, 1.4, 1.5, 1.6, 1.7i 2.0 (Exc Type R) & 1.7D	Rear
PK108	FIAT	07-15	Bravo (198 generation II) 1.4, 1.9 (Exc sport susp)	Rear
PK108	FIAT	03-10	Stilo 1.6 Hatch	Rear
PK108	FIAT	03-10	Stilo 1.8, 1.9 JTD Hatch	Rear
PK108	FIAT	03-10	Stilo 2.4 Abarth Hatch	Rear
PK109	FIAT	00-03	Palio hatch Type 1X Mkl	Front
PK109	FIAT	00-02	Palio Weekend S/Wagon Type PY & 1Y	Front
PK109	FIAT	02-10	Palio II Weekend S/Wagon Type 2G & 2K 1.4 (Exc 2K 1.6)	Front
PK109	FIAT	00-02	Siena sedan Type 2A	Front
PK109	FIAT	03-early 10	Doblo 1.3, 1.4 & 1.9 Cargo panel Van (119) (223)	Front
PK110	FIAT	00-03	Palio hatch Type 1X Mkl	Rear
PK110	FIAT	03-10	Palio II hatch Type 2H MkIV	Rear
PK110	FIAT	01-10	Palio Espresso panel Van	Rear
PK110	FIAT	00-02	Siena sedan Type 2A	Rear
PK110	FIAT	02-10	Siena II sedan	Rear
PK113	TOYOTA	04-March'09	Prius Hybrid (NHW20, XW20) gen 2	Front
PK113 (Bump rubber only)	TOYOTA	Nov'02-Sept'07	  Corolla Sedan & RunX Hatch (Exc Verso MPV, TRD) gen 9 (E120 & E121)	Front
PK114	MAZDA	93-Mid 99	626 Sedan All Exc MX6 (GE)	Front
PK114	MAZDA	93-Mid 99	MX-6	Front
PK116	NISSAN	07-14	Primastar van 1.9 Dci gen 2 (X83)	Front
PK116	OPEL	07-14	Vivaro 1.9CDTi, 2.0 Van & Minibus (X83)	Front
PK116	RENAULT	03 - 14	Trafic 1.9 Dci panel van gen 2 (X83)	Front
PK119	MAZDA	99- 00	Etude (Ch # up to -> ###304194) - J39 (BJ)	Rear
PK119	MAZDA	00 - 00	Etude (Ch ###304195 up to -> ###400000) - J39 (BJ)	Rear
PK120	MAZDA	94- 99	Etude BH / Astina BA - J55 (RSA Mnf)	Front
PK120	MAZDA	99- 00	Etude (Ch # up to -> ###304194) - J39 (BJ)	Front
PK120	MAZDA	00 - 00	Etude (Ch ###304195 up to -> ###400000) - J39 (BJ)	Front
PK120	MAZDA	00-04	Etude (Ch # 's ###400001 - on ->) Exc front 2.0 26v (BJ)	Front
PK121	TOYOTA	90-00	Previa std & GL (ABS) Rear IRS TCR 11 & 21 (gen 1 XR10, XR20)	Front
PK122	FIAT	94- Aug'97	Ulysse MPV	Front
PK122	FIAT	Sept'97-02	Ulysse MPV	Front
PK122	PEUGEOT	96- Sept'97	806 MPV	Front
PK122	PEUGEOT	Oct'97-'02	806 MPV	Front
PK123	VOLKSWAGEN	03 - 06	LT 28, 32, 35 SWB Van Strut body length 319.5mm	Front
PK123	VOLKSWAGEN	03 - 06	LT 28, 32, 35 SWB Van Strut body length 345.5mm	Front
PK123	VOLKSWAGEN	03 - 06	LT 45, 46 LWB Van Strut body length 319.5mm	Front
PK123	VOLKSWAGEN	03 - 06	LT 45, 46 LWB Van Strut body length 345.5mm	Front
PK123	MERCEDES-BENZ	96-05	Sprinter van / bus. B901, B902 = 200 series, B903 = 300 series & B904 = 400 series. Gen 1 NB: Check Strut body length	Front
PK124	CITROEN	April'08-18	Berlingo Multispace MPV & P/Van 800kg to 1000kg payload	Front

Key

*	See important installation information on inside front cover
!	Excluding self-levelling suspension
"..."	Special order - phone 010 900 1850. 6-12 week waiting period

~	Imported
#	Internal bump stop
⊕	Steering damper

- It is recommended that all new shock absorbers are fitted in pairs
- Do not mix gas and non-gas units on the same axle
- **Bold** part numbers indicate heavy-duty shocks
- Underlined part numbers indicate parts not immediately available
- *Italic* part numbers followed by > indicate parts to be discontinued

Protection kits

Part number [numerical listing]

Part number	Make	Year	Application	Position
PK124	CITROEN	05-Oct'10	C4 (Gen 1) 1.6i, 2.0i, 2.0Hdi INC1 Coupe EXC1 DS4 & sport susp)	Front
PK124	CITROEN	08-12	C4 Picasso MPV INC1 air susp	Front
PK124	CITROEN	11-16	DS4 1.6, 2.0	Front
PK124	PEUGEOT	02-10	 (S/W) 307 1.6 & 2.0 hatch & 2.0 S/Wagon EXC1 cc)	Front
PK124	PEUGEOT	March'04-10	 307 CC Cabrio	Front
PK124	PEUGEOT	08-14	308 Hatch, S/W & Cabrio. gen 1 (T7)	Front
PK124	PEUGEOT	09-18	Partner 1.6, 1.6Hdi Tepee 8 seater gen 2 (B9)	Front
PK124	PEUGEOT	09-18	Partner 1.6, 1.6Hdi panel van gen 2, 800 – 1000kg payload (B9)	Front
PK124	CITROEN	Nov'10-16	C4 (Gen 2) 1.6i, 2.0, 2.0 Hdi EXC1 DS4 & sport susp)	Front
PK124	PEUGEOT	09-17	3008 MPV Crossover 1.6, 1.6 T, 2.0 Hdi gen 1 EXC1 self leveling susp) (T8 / OU)	Front
PK124	PEUGEOT	11-14	5008 1.6 THP MPV gen 1 (T8)	Front
PK125	BMW	96-'03	520i, 523i, 525i, 528i, 530d & 530i (E39) EXC1 535i, 540i, Sport susp, M5, Air Susp, M Tech, Elec susp & S/W)	Front
PK125	BMW	96-'03	535i & 540i (E39) EXC1 "protection", M5, Air Susp, M Tech, Sport susp, Elec susp & S/W)	Front
PK125	BMW	97-'03	5 Series Touring S/W EXC1 540i and Sport susp)	Front
PK126	FIAT	01-06	Seicento 1100	Rear
PK130 (Bump rubber only)	ALFA ROMEO	94- 97	145 & 146 1.3, 1.6, 1.7 16v	Rear
PK130 (Bump rubber only)	ALFA ROMEO	94- June 01	145 & 146 1.4TS, 1.6TS, 1.8TS, 1.9TDS & 2.0 TS	Rear
PK130 (Bump rubber only)	ALFA ROMEO	91- 97	155 EXC1 2500 V6, 2.5TD, 2.0 Turbo AWD, elec susp)	Rear
PK130 (Bump rubber only)	ALFA ROMEO	91- 97	155 2500 V6, 2.5TD EXC1 elec susp)	Rear
PK131	CITROEN	Nov'10-16	C4 (Gen 2) 1.6i, 2.0, 2.0 Hdi EXC1 DS4 & sport susp)	Rear
PK131	CITROEN	11-16	DS4 1.6, 2.0	Rear
PK131	PEUGEOT	08-14	 308 1.2T, 1.6 & 1.6Hdi Hatch. EXC1 S/W, Vti, GT, 1.6 Turbo 147kw & CC gen 1 (T7)	Rear
PK131	PEUGEOT	08-14	 308 1.6T, 1.6 Vti & GT Turbo & 2.0Hdi Turbo Hatch. EXC1 S/W & CC gen 1 (T7)	Rear
PK131	PEUGEOT	08-10	(S/W) 308 1.6 S/Wagon EXC1 1.6T gen 1 (T7)	Rear
PK131	PEUGEOT	09-14	 308 Cabrio cc 1.6 T gen 1 (T7)	Rear
PK131	PEUGEOT	09-17	3008 MPV Crossover 1.6, 1.6 T, 2.0 Hdi gen 1 EXC1 self leveling susp) (T8 / OU)	Rear
PK131	CITROEN	05-Oct'10	C4 (Gen 1) 1.6i, 2.0i, 2.0Hdi INC1 Coupe EXC1 DS4 & sport susp)	Rear
PK131	PEUGEOT	02-10	 (S/W) 307 1.6 & 2.0 hatch & 2.0 S/Wagon EXC1 cc)	Rear
PK131	PEUGEOT	March'04-10	 307 CC Cabrio	Rear
PK132	ROVER	01-05	75 Sedan	Front
PK133	TOYOTA	99-05	Yaris / Vitz Hatch EXC1 1.5 T-Sport (Cross border – non RSA) gen 1 (XP10)	Front
PK134	MAZDA	00-04	Etude (Ch # 's ###400001 – on ->) EXC1 front 2.0 26v (BJ)	Rear
PK134	MAZDA	94- 99	Etude BH / Astina BA – J55 (RSA Mnf)	Rear
PK135 (Oval)	AUDI	May'03-12	A3 all INC1 Sportback INC1 Quattro, Sport Susp EXC1 S3) OE Strut leg bottom outer diam 50mm + 55mm	Rear
PK137	AUDI	11 - Sept '18	Q3 2.0TDi, 2.0T 4x2 & 4x4 Quattro EXC1 RS 2.5 sport or elec susp) 8U	Rear
PK137	VOLKSWAGEN	05 - 11	  Passat Sedan & S/Wagon INC1 AWD 4 Motion Syncro EXC1 Sport Susp & Elec Susp) (B6)	Rear
PK137	VOLKSWAGEN	05 - 11	  Passat Sedan, & S/Wagon Sportline Sport Susp INC1 AWD 4 Motion Syncro EXC1 elec susp) (B6)	Rear
PK137	VOLKSWAGEN	11-Aug'15	Passat sedan EXC1 Sport Susp & 4WD 4 Motion Syncro) (B7) EXC1 elec susp	Rear
PK137	VOLKSWAGEN	08-Sept 16	Tiguan 4-Motion AWD & FWD INC1 Blue Motion EXC1 elec susp) gen 1 (5N)	Rear
PK137 EXC1 Quattro (Quattro = "PK101")	AUDI	Dec'00- 04	 +  A4 Sedan & Avant + Quattro EXC1 Sport Susp, S4, & RS4) B6. 8E	Rear

Key











































*	See important installation information on inside front cover
!	Excluding self-levelling suspension
"..."	Special order – phone 010 900 1850. 6-12 week waiting period

~	Imported
#	Internal bump stop
⊕	Steering damper

- It is recommended that all new shock absorbers are fitted in pairs
- Do not mix gas and non-gas units on the same axle
- **Bold** part numbers indicate heavy-duty shocks
- Underlined part numbers indicate parts not immediately available
- *Italic* part numbers followed by > indicate parts to be discontinued

Protection kits

Part number [numerical listing]

Part number	Make	Year	Application	Position
PK137  Quattro (Quattro = "PK101")	AUDI	Dec'00- 04	 +  A4 Sedan and Avant Sport Suspension  Quattro sport  S4 & RS4) B6, 8E	Rear
PK137  Quattro (Quattro = "PK101")	AUDI	05-07	 (S/W) A4  Quattro, Avant & Allroad  Sport susp, S4 & RS4) B7	Rear
PK137  Quattro (Quattro = "PK101")	AUDI	05-07	  A4 Sport susp  Quattro, Avant & Allroad  S4 & RS4) B7	Rear
PK140	OPEL	14-19	Adam 1.0T, 1.4  "S" (M13)	Front
PK140	OPEL	Nov'07-Oct'15	Corsa Hatch  Lite, OPC and Sport) (D)	Front
PK140	OPEL	Nov'15-19	Corsa Hatch 1.0T, 1.4  1.4 Turbo Sport (E)	Front
PK140	FIAT	13-21	Fiorino cargo panel van (327)	Front
PK140	FIAT	13-17	Qubo mini MPV	Front
PK140	FIAT	09-14	Linea sedan 1.4 8v  T-Jet)	Front
PK140	FIAT	March'12-16	Punto 1.2, 1.3 JTD, 1.4 Hatch (199)  sport susp  turbo)	Front
PK140	FIAT	06-16	Grand Punto 1.2, 1.3, 1.4 & 1.9 (199)	Front
PK140	FIAT	16-on	Tipo 1.4 & 1.6 (356)	Front
PK140	ALFA ROMEO	09-18	MiTo hatch 1.4, 1.4T, 1.6JTD  1.4T QV sport, 1.8T GTA & Elec susp)	Front
PK143 >	HYUNDAI	96- Aug'00	Elantra Sedan & S/W gen 2 (J2)	Front
PK143 >	HYUNDAI	94-May'97	 Accent I (X3)	Front
PK143 >	HYUNDAI	July'00-05	 Accent II (LC)	Rear
PK143 >		June'97-June'00	 Accent I (X3) facelift (Larger rear springpan than earlier model)	Rear
PK144	HYUNDAI	June'97-June'00	 Accent I (X3) facelift (Larger rear springpan than earlier model)	Front
PK145 (oval)	VOLKSWAGEN	04-16	Touran MPV  Elec & heavy duty Susp (1T gen 1)	Rear
PK146	TOYOTA	06-09	Avensis 2.0, 2.0D, 2.2D, 2.4 (T250)	Front
PK146	TOYOTA	Oct '07-13	 Corolla Sedan 1.4, 1.6, 1.8, 2.0D gen 10 (E140, E150, E152)	Front
PK146	TOYOTA	14-19	 Corolla QUEST 1.6 gen 10 (E140, E150)	Front
PK147	TOYOTA	99-05	Yaris / Vitz Hatch  1.5 T-Sport (Cross border – non RSA) gen 1 (XP10)	Rear
PK148	FIAT	08-on	500 0.9, 1.2, 1.4 (3 door)  Abarth / sport susp, "L" & "X" models (312)	Front
PK148	FIAT	14-18	500L 1.4, 1.6 (5 door)  Std 500 models, "X" models, Abarth / sport susp (351 & 352)	Front
PK148	FIAT	04-10	Panda 1.2, 1.3  AWD & 1.4 100HP) (169)	Front
PK148	FORD	09-10	Ka 1.3 Hatch	Front
PK150	CITROEN	Dec'09-16	C3 II  DS3 & Sport) (SC) 46mm & 51mm OD strut base	Front
PK150	CITROEN	10-13	C3 Picasso	Front
PK150	CITROEN	11-18	DS3 1.2 & 1.6 46mm OD strut base	Front
PK150	CITROEN	11-18	DS3 1.2 & 1.6 51mm OD strut base	Front
PK150	PEUGEOT	06-12	207 All	Front
PK151	BMW	01-06	X5 (E53) 3.0i, 3.0d, 4.4iV8, 4.8 V8 4x4,  rear air susp  elec or self leveling susp &  front air susp)	Front
PK152	BMW	01-06	X5 (E53) 3.0i, 3.0d, 4.4iV8, 4.8 V8 4x4,  rear air susp  elec or self leveling susp &  front air susp)	Rear
PK153	RENAULT	End 06-March'13	Clio 1.4, 1.5dCi & 1.6  1.2, 2.0 Sport, R27, 2.0 RS) For 1.2 see Clio II above	Front
PK153	NISSAN	04-10	Micra (K12E) gen3	Front
PK153	NISSAN	04-10	Micra (K12E) gen3	Front
PK153	RENAULT	05 - 08	Modus 1.2, 1.4, 1.6 Hatch / mini MPV	Front
<u>PK154</u>	NISSAN	04-10	Micra (K12E) gen3	Rear
<u>PK154</u>	RENAULT	99-13	Clio 1.2  Va va voom  1.2 16v, 1.4 & 1.6, 2.0 & 3.0 V6)	Rear

Key

*	See important installation information on inside front cover
!	Excluding self-leveling suspension
"..."	Special order – phone 010 900 1850. 6-12 week waiting period

~	Imported
#	Internal bump stop
⊕	Steering damper

- It is recommended that all new shock absorbers are fitted in pairs
- Do not mix gas and non-gas units on the same axle
- **Bold** part numbers indicate heavy-duty shocks
- Underlined part numbers indicate parts not immediately available
- *Italic* part numbers followed by > indicate parts to be discontinued

Protection kits

Part number [numerical listing]

Part number	Make	Year	Application	Position
PK154	RENAULT	99-06	Clio 1.2 16v, 1.4, 1.5dCi & 1.6 (EXC) Sport 1.6, 2.0 & 3.0)	Rear
PK154	RENAULT	99-06	Clio 1.6 16v Sport (EXC) 2.0 16v Sport & 3.0 V6 mid engine)	Rear
PK155	HONDA	11-14	Ballade gen 5 (GM2, GM3)	Front
PK155	HONDA	03-04	Jazz 1.4 Dsi & 1.5 Vtec gen 1 (GD)	Front
PK155	HONDA	05-07	Jazz 1.4 Dsi & 1.5 Vtec gen 1 (GD facelift)	Front
PK155	HONDA	08-Jan'15	Jazz 1.4 Dsi & 1.5 Vtec gen 2 (GE)	Front
PK156	VOLVO	07-13	C30 Hatch	Front
PK156	VOLVO	06-14	 C70 Cabriolet	Front
PK156	VOLVO	June'04-Oct'12	S40 Sedan & V50 S/W (EXC) T5 (Gen 2)	Front
PK156	FORD	11-12	Kuga 4x2 & 4x4 SUV (gen 1) C394	Front
PK156	MAZDA	05-10	Mazda 5 MPV Gen 2 (CR19)	Front
PK156	MAZDA	11-15	Mazda 5 MPV Gen 3 (CW)	Front
PK156	FORD	Nov'04-July'11	Focus 1.6, 1.6Si, 1.8TDCi, 2.0, 2.0Si, 2.0TDCi & TDCi Si, (EXC) 2.5 ST front only, Hatch and Sedan MkII DA, DP (EXC) 2.5 ST rear & RS)	Front
PK156	FORD	Aug'11-15	Focus 1.0, 1.5, 1.6, 2.0Si, 2.0TDCi & TDCi Si, (EXC) 2.0ST front only, Hatch and Sedan MkIII C346 (EXC) 2.0ST rear, RS, & facelift models)	Front
PK156	MAZDA	04-09	Mazda 3 gen 1 (BK) (EXC) MPS, sport susp or AWD	Front
PK156	MAZDA	Mid 09-Sept'14	Mazda 3 gen 2 (BL) (EXC) MPS, sport susp or AWD	Front
PK157	MAZDA	03-07	Mazda 6 (EXC) MPS gen 1 (GG)	Front
PK159	RENAULT	Sept'04-end 09	Grand Scenic II (LWB) 1.9dCi, 2.0	Front
PK160	HYUNDAI	07-09	Santa Fe 4x2 & 4x4 Gen 2 (CM) (EXC) elec or self-levelling susp)	Front
PK160	KIA	Oct'04-Sept'10	Sportage 4x4 & 4x2 Gen 2 (JE / KM)	Front
PK160	KIA	Oct'04-Sept'10	Sportage 4x4 & 4x2 Gen 2 (JE / KM)	Rear
PK160	HYUNDAI	04 - 10	Tucson All (JM) gen 1	Front
PK160	HYUNDAI	04 - 10	Tucson All (JM) gen 1	Rear
PK161	FIAT	04-Feb'12	Punto 1.2, 1.3 JTD, 1.4 Hatch (MkII) (188)	Front
PK161	FIAT	04-05	Punto 1.8 HGT 1.6v 3 door Hatch, plus 1.4 Sport Susp (MkII) (188)	Front
PK162	RENAULT	June'04-08	 Megane II cc Coupe 1.6, 1.9dCi, 2.0	Front
PK162	RENAULT	March'04-end 09	Scenic II 1.6, 1.9dCi, 2.0	Front
PK162	RENAULT	03-08	Megane II Sedan & Hatch All (EXC) Shake it (EXC) 2.0 T Sport)	Front
PK162	RENAULT	June'04-08	 Megane II cc Cabriolet 1.6, 1.9dCi, 2.0	Front
PK163	AUDI	May'03-12	A3 all (EXC) Sportback (EXC) Quattro, Sport Susp & S3) OE Strut leg bottom outer diam = 50mm	Front
PK163	AUDI	May'03-12	A3 all (EXC) Sportback (EXC) Quattro, Sport Susp & S3) OE Strut leg bottom outer diam = 55mm	Front
PK163	AUDI	May'03-12	A3 & S3 Quattro and sport suspension 2.0 & 3.2 : 55mm OD strut only (EXC) S3 front & all RS3)	Front
PK163	AUDI	11 - Sept '18	Q3 2.0TDI, 2.0T 4x2 & 4x4 Quattro (EXC) RS 2.5 sport or elec susp) 8U	Front
PK163	SEAT	06-10	Altea Mini MPV OE Strut leg outer diam = 50mm	Front
PK163	SEAT	06-10	Altea Mini MPV OE Strut leg outer diam = 55mm	Front
PK163	SEAT	06-08	Leon Hatch (EXC) Cupra & Sport susp) OE Strut leg outer diam = 50mm	Front
PK163	SEAT	06-08	Leon Hatch (EXC) Cupra & Sport susp) OE Strut leg outer diam = 55mm	Front
PK163	VOLKSWAGEN	04-Feb'09	Golf V (EXC) Gti, V5, R32 & Sport susp) 1K1. OE Strut leg bottom outer diam = 50mm	Front
PK163	VOLKSWAGEN	04-Feb'09	Golf V (EXC) Gti, V5, R32 & Sport susp) 1K1. OE Strut leg bottom outer diam = 55mm	Front
PK163	VOLKSWAGEN	04-Feb'09	Golf V Gti & R32 (EXC) 4-motion AWD	Front
PK163	VOLKSWAGEN	March'09-13	Golf VI (EXC) Gti, V5, R32, AWD, Elec & Sport susp) OE Strut leg bottom outer diam = 50mm	Front

Key







*	See important installation information on inside front cover
!	Excluding self-levelling suspension
...	Special order - phone 010 900 1850. 6-12 week waiting period

~	Imported
#	Internal bump stop
⊕	Steering damper

- It is recommended that all new shock absorbers are fitted in pairs
- Do not mix gas and non-gas units on the same axle
- **Bold** part numbers indicate heavy-duty shocks
- Underlined part numbers indicate parts not immediately available
- *Italic* part numbers followed by > indicate parts to be discontinued

Protection kits

Part number [numerical listing]

Part number	Make	Year	Application	Position
PK163	VOLKSWAGEN	March'09-13	Golf VI EXC1 Gti, V5, R32, AWD, Elec & Sport susp) OE Strut leg bottom outer diam = 55mm	Front
PK163	VOLKSWAGEN	March'09-13	Golf VI Gti & R32 EXC1 4-motion AWD EXC1 elec susp	Front
PK163	VOLKSWAGEN	March'06-Sept'11	Jetta V EXC1 V5 & Sport susp) 1K2 (A5). Strut leg bottom outer diam = 50mm	Front
PK163	VOLKSWAGEN	March'06-Sept'11	Jetta V EXC1 V5 & Sport susp) 1K2 (A5) OE Strut leg bottom outer diam = 55mm	Front
PK163	VOLKSWAGEN	Oct'11-19	Jetta VI EXC1 V5 & Sport susp) 1B (A6). OE Strut leg bottom outer diam = 50mm	Front
PK163	VOLKSWAGEN	Oct'11-19	Jetta VI EXC1 V5 & Sport susp) 1B (A6) OE Strut leg bottom outer diam = 55mm	Front
PK163	VOLKSWAGEN	05 - 11	  Passat Sedan & S/Wagon EXC1 AWD 4 Motion Syncro EXC1 Sport Susp & Elec Susp) (B6)	Front
PK163	VOLKSWAGEN	05 - 11	  Passat Sedan, & S/Wagon Sportline Sport Susp EXC1 AWD 4 Motion Syncro EXC1 elec susp) (B6)	Front
PK163	VOLKSWAGEN	11-Aug'15	Passat sedan EXC1 Sport Susp & 4WD 4 Motion Syncro) (B7) EXC1 elec susp	Front
PK163	VOLKSWAGEN	09-17	Scirocco EXC1 elec, R or sport susp (137)	Front
PK163	VOLKSWAGEN	08-Sept 16	Tiguan 4-Motion AWD & FWD EXC1 Blue Motion EXC1 elec susp) gen 1 (5N)	Front
PK163	VOLKSWAGEN	04-16	Touran MPV EXC1 Elec & heavy duty Susp (1T gen 1)	Front
PK163	VOLKSWAGEN	09-17	"Passat" CC EXC1 AWD 4-Motion Syncro EXC1 elec susp)	Front
PK163	VOLKSWAGEN	04 - May 15	Caddy All gen 3 (2K) (check front strut OD for correct part) 50mm OD strut tube	Front
PK163	VOLKSWAGEN	04 - May 15	Caddy All gen 3 (2K) (check front strut OD for correct part) 55mm OD Strut tube	Front
PK163	VOLKSWAGEN	June 15-Oct '21	Caddy All gen 3, (2K Facelift)	Front
PK163	VOLKSWAGEN	07-15	Eos Cabriolet	Front
PK164	OPEL	10-17	Meriva 1.4 mini MPV (B)	Front
PK164	OPEL	10-17	Meriva 1.4 mini MPV (B)	Front
PK164	OPEL	July '05-10	Zafira 1.6, 1.8, 1.9CDTi MPV (Exc OPC, Sport & Panoramic) (B)	Front
PK164	FIAT	06-09	Croma (generation II)	Front
PK164	OPEL	Sept'04-09	Astra All (EXC1 OPC, Elec susp) (model H)	Front
PK164	OPEL	Sept'04-09	Astra All (EXC1 OPC, Elec susp) (model H)	Front
PK164	OPEL	07-10	Astra Twintop 1.8 & 2.0 	Front
PK164	OPEL	07-10	Astra Twintop 1.8 & 2.0 	Front
PK165	RENAULT	02 - 14	Espace + Grand Espace 2.0, 2.2dCi, 3.5 V6 MPV	Front
PK166	BMW	Nov'03-May'10	All E60 5 Series sedan EXC1 Touring S/W, M5 & Sport susp)	Rear
PK166	BMW	Nov'03-May'10	All E60 5 Series sedan Sport susp EXC1 Touring S/W, & M5)	Rear
PK167	BMW	End 04-Oct'11	1 Series Inclm Sport Susp, EXC1 xDrive & 135i Coupe)	Rear
PK167	BMW	End 04-Oct'11	1 Series Inclm Sport Susp, EXC1 xDrive & 135i Coupe)	Rear
PK167	BMW	End 04-Oct'11	1 Series Inclm Sport Susp, EXC1 xDrive & 135i Coupe)	Rear
PK167	BMW	March'05-12	3 series [E90 & E91] EXC1 Sport susp EXC1 M3, Cabrio & Coupe)	Rear
PK167	BMW	March'05-12	3 series [E90 & E91] EXC1 Sport susp EXC1 M3, Cabrio & Coupe)	Rear
PK167	BMW	07-12	330i, 335i Cabriolet EXC1 M3, Coupe) [E93] + 320i, 325i, 335i Coupe EXC1 M3, Cabrio) [E92]	Rear
PK167	BMW	07-12	330i, 335i Cabriolet EXC1 M3, Coupe) [E93] + 320i, 325i, 335i Coupe EXC1 M3, Cabrio) [E92]	Rear
PK167	BMW	07-12	330i, 335i Cabriolet EXC1 M3, Coupe) [E93] + 320i, 325i, 335i Coupe EXC1 M3, Cabrio) [E92]	Rear
PK167	BMW	10-Oct 15	X1 [E84] sDrive FWD & X1 [E84] xDrive AWD	Rear
PK167	BMW	10-Oct 15	X1 [E84] sDrive FWD & X1 [E84] xDrive AWD	Rear
PK167	BMW	10-Oct 15	X1 [E84] sDrive FWD & X1 [E84] xDrive AWD	Rear
PK168	FORD	04-Oct'08	 Fiesta Sedan & Hatch Mk 5 JH, JD EXC1 2.0ST EXC1 2.5 ST or RS)	Front
PK168	FORD	07-15	Ikon sedan All	Front

Key









*	See important installation information on inside front cover
!	Excluding self-levelling suspension
"..."	Special order - phone 010 900 1850. 6-12 week waiting period

~	Imported
#	Internal bump stop
⊕	Steering damper

- It is recommended that all new shock absorbers are fitted in pairs
- Do not mix gas and non-gas units on the same axle
- **Bold** part numbers indicate heavy-duty shocks
- Underlined part numbers indicate parts not immediately available
- *Italic* part numbers followed by > indicate parts to be discontinued

Protection kits

Part number [numerical listing]

Part number	Make	Year	Application	Position
PK168	FORD	10-Nov 15	Figgo Hatch 1.4 gen 1	Front
PK170	MERCEDES-BENZ	06-March'12	B170, B200T, B200CDi (W245)	Front
PK170	MERCEDES-BENZ	05-12	A170, A180CDi, A200 (W169)	Front
PK171	RENAULT	01-07	Laguna II All, MC1 S/Wagon (X74)	Front
PK172	BMW	04-10	X3 (E83) 2.5, 3.0 & 2.0 d MC1 Sport susp EX1 elec susp)	Rear
PK173	CHEVROLET	Aug'04-11	 Corsa Utility LDV	Front
PK173	OPEL	02-11	Combo Panel Van (C)	Front
PK173	OPEL	End 02-Oct'07	Corsa Hatch & Classic (sedan) EX1 Lite) (C)	Front
PK173	OPEL	End 02-Oct'07	Corsa Hatch & Classic (sedan) EX1 Lite) (C)	Front
PK173	OPEL	8/04-10	Corsa Utility LDV	Front
PK173	OPEL	03-09	Meriva 1.4, 1.6, 1.7CDTi, 1.8 mini MPV (A)	Front
PK173	OPEL	03-09	Meriva 1.4, 1.6, 1.7CDTi, 1.8 mini MPV (A)	Front
PK173	OPEL	05 - 09	Tigra 1.4, 1.8 TwinTop Cabriolet	Front
PK174	FORD	11-12	Kuga 4x2 & 4x4 SUV (gen 1) C394	Rear
PK174	FORD	Nov'04-July'11	Focus 1.6, 1.6Si, 1.8TDCi, 2.0, 2.0Si, 2.0TDCi & TDCi Si, MC1 2.5 ST front only, Hatch and Sedan MkII DA, DP EX1 2.5 ST rear & RS)	Rear
PK174	FORD	Nov'04-July'11	Focus hatch MkII 2.5 ST & RS only	Rear
PK174	FORD	Aug'11-15	Focus 1.0, 1.5, 1.6, 2.0Si, 2.0TDCi & TDCi Si, MC1 2.0ST front only, Hatch and Sedan MkIII C346 EX1 2.0ST rear, RS, & facelift models)	Rear
PK174	FORD	15-early18	Focus (facelift) 1.0, 1.5, 1.6, 2.0Si, 2.0TDCi, TDCi Si, MC1 2.0ST front only, Hatch and Sedan MkIII C346 facelift EX1 2.0 ST rear & RS)	Rear
PK175	AUDI	Dec'00- 04	 +  A4 Sedan & Avant + Quattro EX1 Sport Susp, S4, & RS4) B6, 8E	Front
PK175	AUDI	Dec'00- 04	 +  A4 Sedan and Avant Sport Suspension MC1 Quattro sport EX1 S4 & RS4) B6, 8E	Front
PK175	AUDI	05-07	 (S/W) A4 MC1 Quattro, Avant & Allroad EX1 Sport susp, S4 & RS4) B7	Front
PK175	AUDI	05-07	  A4 Sport susp MC1 Quattro, Avant & Allroad EX1 S4 & RS4) B7	Front
PK175	AUDI	02-08	 A4 Cabriolet MC1 Sport susp	Front
PK176	BMW	Nov'03-May'10	All E60 5 Series sedan EX1 Touring S/W, M5 & Sport susp)	Front
PK176	BMW	Nov'03-May'10	All E60 5 Series sedan Sport susp EX1 Touring S/W, & M5)	Front
PK176	BMW	04-May'10	All E61 5 Series Touring EX1 Sedan, M5 & Sport susp)	Front
PK176	BMW	10-Oct 15	X1 (E84) sDrive FWD	Front
PK176	BMW	10-Oct 15	X1 (E84) xDrive AWD	Front
PK177	BMW	04-May'10	All E61 5 Series Touring EX1 Sedan, M5 & Sport susp)	Rear
PK178	CITROEN	08-14	C1 1.0 & 1.4 Hdi Gen 1 (PM)	Front
PK178	TOYOTA	11-Sept'15	Aygo hatch gen 1 (AB10)	Front
PK178	TOYOTA	Oct'15-21	Aygo hatch gen 2 (AB40) EX1 Ayga models	Front
PK178	PEUGEOT	07-15	107 Hatch 1.0	Front
PK181	TOYOTA	07-March'13	Auris 1.4, 1.6, 1.8, 2.0 hatch (E150 / 330N) EX1 TRD	Front
PK181	TOYOTA	April'13-19	Auris (E180)	Front
PK182	HYUNDAI	00-08	Atos & Atos Prime (FF/MX)	Front
PK183	KIA	March'06-Oct'11	Rio 1.4, 1.6 gen 2 (JB)	Front
PK183	HYUNDAI	Aug'00-Oct'06	Elantra Sedan & S/W gen 3 (XD)	Front
PK183	HYUNDAI	06-July'11	  Accent III (MC)	Front
PK183	HYUNDAI	03-11	Getz (TB)	Front
PK184	VOLVO	June'04-Oct'12	S40 Sedan & V50 S/W MC1 T5 (Gen 2)	Rear

Key













*	See important installation information on inside front cover
!	Excluding self-levelling suspension
***	Special order - phone 010 900 1850, 6-12 week waiting period

~	Imported
#	Internal bump stop
⊕	Steering damper

- It is recommended that all new shock absorbers are fitted in pairs
- Do not mix gas and non-gas units on the same axle
- **Bold** part numbers indicate heavy-duty shocks
- Underlined part numbers indicate parts not immediately available
- *Italic* part numbers followed by > indicate parts to be discontinued

Protection kits

Part number [numerical listing]

Part number	Make	Year	Application	Position
PK184	VOLVO	07-13	C30 Hatch	Rear
PK184	VOLVO	06-14	 C70 Cabriolet	Rear
PK188	PEUGEOT	Mid 04-10	407 Sedan 2.0 ST (exc) elec susp)	Front
PK188	PEUGEOT	Mid 04-10	407 Sedan 2.0 Hdi, 2.2 ST Sport, 3.0 ST (exc) Coupe & Elec susp)	Front
PK188	PEUGEOT	End 04-08	407 S/Wagon 2.0 Hdi, 2.2 Sport, 3.0 Sport (exc) elec susp)	Front
PK190	RENAULT	11-17	Fluence sedan	Front
PK190	RENAULT	end 09-16	Scenic III MPV 1.6, 1.9dCi	Front
PK190	RENAULT	end 09-16	Grand Scenic III (LWB) 1.9dCi	Front
PK190	RENAULT	09-Aug 16	Megane III Hatch 1.2T, 1.4T, 1.6, 1.9dCi (exc) 2.0T GT, RS & Sport susp)	Front
PK190	RENAULT	09-Aug 16	Megane III cc Coupe (exc) Cabriolet & 2.0T GT, & RS)	Front
PK275	ALFA ROMEO	05-11	159	Front
PK276	AUDI	06 - June'15	Q7 4x4 Quattro (exc) sport or air susp) Gen one 4L (inc) facelift	Rear
PK277 (Round)	AUDI	May'03-12	A3 all (inc) Sportback (inc) Quattro, Sport Susp (exc) S3) OE Strut leg bottom outer diam 50mm + 55mm	Rear
PK278	AUDI	08 - 17	Q5 4x4 Quattro (exc) sport susp) Typ 8R	Front
<u>PK279</u>	AUDI	11-19	A6 Sedan & Avant (inc) Quattro (exc) Air & Elec susp) C7 Typ 4G	Rear
<u>PK279</u>	AUDI	11-19	A6 Sedan & Avant (inc) Quattro (exc) Air & Elec susp) C7 Typ 4G	Rear
PK279	AUDI	08 - 17	Q5 4x4 Quattro (exc) sport susp) Typ 8R	Rear
PK279	AUDI	08-Jan 16	  A4 Sedan & Avant (exc) Sport susp, Quattro, Elec susp & S4) B8	Rear
PK279	AUDI	08-Jan 16	  A4 Sedan & Avant Sport Susp, (inc) Quattro (exc) S4 & Elec susp) B8	Rear
PK279	AUDI	08-Jan '16	A5 Sportback Coupe, Cabrio & Quattro (exc) Sport Susp, S5 & RS5) (8T, B8)	Rear
PK279	AUDI	08-Jan 16	S5 Sportback Coupe & Cabrio (inc) A5 Sport Susp, Quattro (exc) RS5 4.2 V8 (8T)	Rear
PK280	AUDI	06 - June'15	Q7 4x4 Quattro (exc) sport or air susp) Gen one 4L (inc) facelift	Front
PK281	AUDI	08-Jan 16	  A4 Sedan & Avant (exc) Sport susp, Quattro, Elec susp & S4) B8	Front
PK281	AUDI	08-Jan 16	  A4 Sedan & Avant Sport Susp, (inc) Quattro (exc) S4 & Elec susp) B8	Front
PK281	AUDI	08-Jan '16	A5 Sportback Coupe, Cabrio & Quattro (exc) Sport Susp, S5 & RS5) (8T, B8)	Front
PK281	AUDI	08-Jan 16	S5 Sportback Coupe & Cabrio (inc) A5 Sport Susp, Quattro (exc) RS5 4.2 V8 (8T)	Front
PK281	AUDI	11-early '18	A7 Sportback (inc) Quattro (exc) Air or elec susp, and S7 or RS7 4.0 V8) 4G8	Front
PK282	CHEVROLET	03-09	Optra J200	Front
PK283	CHEVROLET	03-09	Optra J200	Rear
PK285	FIAT	July'06-on	  Ducato SWB & LWB Van & Minibus (Q11, Q15, Q17, Q20) Gen 3	Front
PK285	FIAT	July'06-on	  Ducato SWB & LWB Van & Minibus (Q11, Q15, Q17, Q20) Gen 3	Front
PK285	CITROEN	11-18	Jumper Van (Check original front piston rod outer diameters, & original rear open and closed lengths for correct shock selection)	Front
PK285	PEUGEOT	April '06-on	Boxer 2.2 Hdi, 3.0 Hdi Van LWB gen 3 (12Q, 14Q, 16Q, 20Q) 3.3 & 4.0 ton (exc) 4x4)	Front
PK286	NISSAN	08-24	NP200 3/4 ton LDV	Front
PK286	RENAULT	13-Sept '18	Duster 4x2 1.6, 1.5dci (exc) Auto) gen 1 (HS)	Front
PK286	RENAULT	13-Sept '18	Duster 4x4 1.6, 1.5dci (exc) Auto) gen 1 (HS)	Front
PK286	RENAULT	Oct 18-on	Duster 4x2 1.5dCi & 1.6 gen 2 (HM)	Front
PK286	RENAULT	Oct 18-on	Duster 4x4 1.5dCi gen 2 (HM)	Front
PK286	RENAULT	08-12	Logan sedan (U90)	Front
PK286	RENAULT	March'14-20	Sandero 0.9 hatch (exc) Stepway) (B8 gen 2)	Front
PK286	RENAULT	March'14-20	Sandero 0.9 Stepway (B8 gen 2)	Front

Key

*	See important installation information on inside front cover
!	Excluding self-levelling suspension
"..."	Special order - phone 010 900 1850. 6-12 week waiting period

~	Imported
#	Internal bump stop
⊕	Steering damper

- It is recommended that all new shock absorbers are fitted in pairs
- Do not mix gas and non-gas units on the same axle
- **Bold** part numbers indicate heavy-duty shocks
- Underlined part numbers indicate parts not immediately available
- *Italic* part numbers followed by > indicate parts to be discontinued

Protection kits

Part number [numerical listing]

Part number	Make	Year	Application	Position
PK286	RENAULT	09-Feb'14	Sandero hatch (30) Stepway) (B90 / BS gen 1)	Front
PK286	RENAULT	09-Feb'14	Sandero Stepway (BS gen 1)	Front
PK288	FIAT	03-10	Multipla MPV 1.6, 1.9JTD (30) Bi-power)	Front
PK289	SUZUKI	End'08-March'14	SX4 2.0 4x2 SUV (30) OE raised susp (GY, EY, RW)	Front
PK289	SUZUKI	End'08-March'14	SX4 2.0 4x4 SUV (GY, EY, RW)	Front
PK291	FORD	Nov'08-Oct '12	Fiesta Sedan & Hatch Mk 6 CB1, CCN (MC) 1.6 ST)	Front
PK291	FORD	Nov 12-17	 Fiesta Sedan & Hatch Mk 6 facelift (30) ST)	Front
PK291	FORD	Dec 15-18	Figgo Hatch & sedan 1.5 gen 2 (30) Freestyle Cross)	Front
PK291	FORD	18-21	Figgo Hatch & sedan gen 3	Front
PK291	MAZDA	07-Feb'15	Mazda 2 (DE)	Front
PK291	MAZDA	07-Feb'15	Mazda 2 (DE)	Front
PK291	FORD	15-17	B-Max Mini MPV 1.0 (JK)	Front
PK291	FORD	13-on	EcoSport cross-over SUV 1.0T, 1.5, 1.5TDCi (Gen 2)	Front
PK292	VOLVO	10-18	S60 Sedan, gen 2 (30) elec susp	Front
PK292	VOLVO	Aug'06-'14	S80 Sedan gen 2 (30) elec susp, T6, Four-C, Lowered, sport & Nivomat Leveling Suspensions)	Front
PK292	VOLVO	Aug'06-'14	S80 Sedan T6 AWD gen 2 All (30) elec susp, Lowered & Nivomat Leveling Suspensions)	Front
PK292	VOLVO	11-18	V60 S/Wagon (MC) Cross Country (30) elec susp	Front
PK292	VOLVO	07-10	V70 S/Wagon Gen 3 (30) D5, T6, Four-C AWD, V70 R, Elec susp, XC 4WD	Front
PK294	HONDA	03-08	Accord Sedan (30) Type-R, ABS & S/W) 7th Gen (CM)	Rear
PK294	HONDA	03-09	Accord S/Wagon 7th Gen (30) ABS & sport susp) (CM)	Rear
PK295	HYUNDAI	09-June'12	i30 Hatch (FD) gen 1	Front
PK296	HYUNDAI	01-06	Santa Fe 4x2 & 4x4 Gen 1 (SM)	Rear
PK297	KIA	March'06-Oct'11	Rio 1.4, 1.6 gen 2 (JB)	Rear
<i>PK297 ></i>	HYUNDAI	06-July'11	  Accent III (MC)	Rear
PK298	HYUNDAI	June'14-July '20	Grand i10 Hatch 1,25 gen 2 (BA)	Rear
PK298	KIA	04-June'11	Picanto 1.0, 1.1 Hatch (SA / BA) gen 1	Rear
PK298	KIA	July'11-June '17	Picanto 1.0, 1.2 Hatch (TA) gen 2	Rear
<u>PK298</u>	KIA	July 17-on	Picanto 1.0, 1.2 Hatch (JA) gen 3	Rear
PK299	KIA	09-12	Cee'd hatch 2.0 3-door (ED)	Front
<u>PK300</u>	HYUNDAI	09-June'12	i30 Hatch (FD) gen 1	Rear
<u>PK300</u>	KIA	09-12	Cee'd hatch 2.0 3-door (ED)	Rear
<u>PK300</u> (for G1094)	HYUNDAI	July'12-16	i30 Hatch (GD) gen 2	Rear
PK301	MERCEDES-BENZ	5/07-May'14	C180, C200, C220Cdi, C230, C250, C250Cdi, C280, C300, C320Cdi, C350Cdi & C350 (30) elec susp, Self level susp, AMG, Coupe, 4-Matic & Sports susp)	Front
PK301	MERCEDES-BENZ	12-May'14	C Class Coupe (30) Sport susp & AMG (Check if std or elec susp)	Front
PK302	VOLKSWAGEN	06-17	Crafter 3 ton and 3.5 ton, (30) 4x4 & 5 ton (2E/2F)	Front
PK302	VOLKSWAGEN	06-17	Crafter 5 ton, (30) 4x4, 3 ton & 3.5 ton (2E/2F)	Front
<u>PK302</u> (dust cover only)	MERCEDES-BENZ	06-18	Sprinter 3 ton and 3.5 ton (30) 4x4 gen 2 (B906)	Front
<u>PK302</u> (dust cover only)	MERCEDES-BENZ	06-18	Sprinter 5 ton (30) 4x4 (B906)	Front

Key

*	See important installation information on inside front cover
!	Excluding self-levelling suspension
"..."	Special order - phone 010 900 1850, 6-12 week waiting period

~	Imported
#	Internal bump stop
⊕	Steering damper

- It is recommended that all new shock absorbers are fitted in pairs
- Do not mix gas and non-gas units on the same axle
- **Bold** part numbers indicate heavy-duty shocks
- Underlined part numbers indicate parts not immediately available
- *Italic* part numbers followed by > indicate parts to be discontinued

Protection kits

Part number [numerical listing]

Part number	Make	Year	Application	Position
PK303	MERCEDES-BENZ	Aug'02-09	W211 E200K, E220 Cdi, E240, E270CDi, E280, E320, E350, E500, E320CDi (30) S/Wagon, AMG & Elec & air susp)	Front
PK303	MERCEDES-BENZ	Aug'02-mid 09	S211 S/Wagon E200K, E220 Cdi, E280, E320CDi, E350, E500 (30) AMG & Elec & air susp)	Front
PK304	SMART	End 04-07	ForFour 1.3 Pulse & 1.5 Passion (W454 gen 1)	Rear
PK305	MAZDA	01 -06	Lancer 1.6 (30) Evo (CS3A gen 8)	Front
PK305	MAZDA	03 -May'04	Outlander 2.0, 2.4 SUV (Gen 1) CU2W, CU5W	Front
PK305	MAZDA	June'04 -May'07	Outlander 2.0, 2.4 SUV (Gen 1) CU2W, CU5W	Front
PK306	NISSAN	01 - May'06	 Almera Sedan (30) Hatch (N16) (10) ABS	Rear
PK306	NISSAN	01-'03	 Almera / Sunny Hatch (N16E)	Rear
PK307	NISSAN	April '08-Aug'14	X-Trail All gen 2 (T31)	Front
PK307	RENAULT	08-13	Koleos 4x4 SUV gen 1 (HY)	Front
PK307	NISSAN	07-09	Qashqai SUV All (J10)	Front
PK307	NISSAN	10-June'14	Qashqai SUV (10) all +2, 1.5dci, 1.6, 2.0 (J10 facelift)	Front
PK307	NISSAN	10-June'14	Qashqai SUV 2.0 dci (J10 facelift, (30) +2)	Front
PK308	NISSAN	01 - May'06	 Almera Sedan (30) Hatch (N16) (10) ABS	Front
PK308	NISSAN	01-'03	 Almera / Sunny Hatch (N16E)	Front
PK309	NISSAN	07-09	Qashqai SUV All (J10)	Rear
PK309	NISSAN	10-June'14	Qashqai SUV (10) all +2, 1.5dci, 1.6, 2.0 (J10 facelift)	Rear
PK309	NISSAN	10-June'14	Qashqai SUV 2.0 dci (J10 facelift, (30) +2)	Rear
PK310	NISSAN	02-March'08	X-Trail All gen1 (T30)	Front
PK311	NISSAN	02-March'08	X-Trail All gen1 (T30)	Rear
PK313	PEUGEOT	Mid 04-10	407 Sedan 2.0 ST (30) elec susp)	Rear
PK313	PEUGEOT	Mid 04-10	407 Sedan 2.0 Hdi, 2.2 ST Sport, 3.0 ST (30) Coupe & Elec susp)	Rear
PK313	PEUGEOT	End 04-08	407 S/Wagon 2.0 Hdi, 2.2 Sport, 3.0 Sport (30) elec susp)	Rear
PK313	PEUGEOT	11-18	508 sedan gen 1 (W23, 8D)	Rear
PK313	PEUGEOT	3/06 - 10	407 Coupe 2.2, 2.7 Hdi, 3.0 (30) elec susp)	Front
PK314	NISSAN	08-24	NP200 3/4 ton LDV	Rear
PK314	RENAULT	13-19	Captur 0.9T, 1.2T, 1.5dci crossover SUV gen 1 (J87, J5, H5)	Rear
PK314	RENAULT	End 06-March'13	Clio 1.4, 1.5dCi & 1.6 (30) 1.2, 2.0 Sport, R27, 2.0 RS) For 1.2 see Clio II above	Rear
PK314	RENAULT	08-12	Logan sedan (U90)	Rear
PK314	RENAULT	05 - 08	Modus 1.2, 1.4, 1.6 Hatch / mini MPV	Rear
PK314	RENAULT	13-Sept '18	Duster 4x4 1.6, 1.5dci (30) Auto) gen 1 (HS)	Rear
PK314	RENAULT	Oct 18-on	Duster 4x4 1.5dCi gen 2 (HM)	Rear
PK315	RENAULT	08-Nov '20	Kangoo 2 MPV & minivan (Check OE front strut outer diameter & bottom bracket width for correct selection)	Front
PK315	RENAULT	08-Nov '20	Kangoo 2 MPV & minivan (Check OE front strut outer diameter & bottom bracket width for correct selection)	Front
PK318	SAAB	03-10	  9.3 Sedan 1.9TiD, 2.0 and 2.0T (10) Convertible	Front
PK321	SUBARU	98 - May'02	Forester 1 AWD 2.0 & 2.5 (30) Self leveling, elec or air susp) (SF gen 1)	Front
PK324	SUZUKI	05-20	Grand Vitara 4x4 2.4i, 3.2i gen 3 (JT)	Front
PK325	TOYOTA	04-Oct'09	Corolla Verso MPV (AR10)	Front
PK326	TOYOTA	04-Oct'09	Corolla Verso MPV (AR10)	Rear
PK326	TOYOTA	Nov'02-Sept'07	  Corolla Sedan & RunX Hatch (30) Verso MPV, TRD) gen 9 (E120 & E121)	Rear
PK326	TOYOTA	Nov'02-Sept'07	  "Bubble" Corolla Sedan & Hatch Cross border export mkt (30) Verso MPV, TRD) 1NZ	Rear

Key





*	See important installation information on inside front cover
!	Excluding self-leveling suspension
"..."	Special order - phone 010 900 1850. 6-12 week waiting period

~	Imported
#	Internal bump stop
⊕	Steering damper

- It is recommended that all new shock absorbers are fitted in pairs
- Do not mix gas and non-gas units on the same axle
- **Bold** part numbers indicate heavy-duty shocks
- Underlined part numbers indicate parts not immediately available
- *Italic* part numbers followed by > indicate parts to be discontinued

Protection kits

Part number [numerical listing]

Part number	Make	Year	Application	Position
PK329	VOLKSWAGEN	04-10	Touareg 4x4 EXC Elec, air or sport susp (7L)	Front
PK330	VOLKSWAGEN	Aug'04 - 15	Type V Caravelle, Kombi, Crew bus, Transporter LCV & Van T5 INC 4Motion 4WD (front engine) EXC front struts with bottom camber brackets	Front
PK330	VOLKSWAGEN	16 - 0n	Type VI T6 Caravelle, California, Kombi, Transporter van, Crew bus & Van INC 4Motion 4WD EXC elec susp	Front
"PK331" (round)	VOLKSWAGEN	04-16	Touran MPV EXC Elec & heavy duty Susp (1T gen 1)	Rear
PK332	FIAT	08-on	500 0.9, 1.2, 1.4 (3 door) EXC Abarth / sport susp, "L" & "X" models (312)	Rear
PK332	FIAT	14-18	500L 1.4, 1.6 (5 door) EXC Std 500 models, "X" models, Abarth / sport susp (351 & 352)	Rear
PK332	FIAT	04-10	Panda 1.2, 1.3 EXC AWD & 1.4 100HP (169)	Rear
PK332	FORD	09-10	Ka 1.3 Hatch	Rear
PK333	TOYOTA	11-Sept'15	Aygo hatch gen 1 (AB10)	Rear
PK333	TOYOTA	05 - Sept'11	Yaris Hatch & (Vios) Sedan (NBC2) gen 2 (XP90)	Rear
PK333	TOYOTA	Oct'11- 19	Yaris Hatch 1.0, 1.3 & Sedan gen 3 (XP130)	Rear
PK333	CITROEN	08-14	C1 1.0 & 1.4 Hdi Gen 1 (PM)	Rear
PK333	PEUGEOT	07-15	107 Hatch 1.0	Rear
PK333	TOYOTA	Oct'15-21	Aygo hatch gen 2 (AB40) EXC Agya models	Rear
PK334	FIAT	07-15	Bravo (198 generation II) 1.4, 1.9 EXC sport susp	Front
PK335	FIAT	13-21	Fiorino cargo panel van (327)	Rear
PK335	FIAT	13-17	Qubo mini MPV	Rear
PK336	HONDA	03-08	Accord Sedan EXC Type-R, ABS & S/W 7th Gen (CM)	Front
PK336	HONDA	03-09	Accord S/Wagon 7th Gen EXC ABS & sport susp (CM)	Front
PK337	HYUNDAI	08-18	i10 Hatch gen 1 (PA)	Front
PK337	KIA	04-June'11	Picanto 1.0, 1.1 Hatch (SA / BA) gen 1	Front
PK337	KIA	July'11-June '17	Picanto 1.0, 1.2 Hatch (TA) gen 2	Front
PK338	KIA	03-06	Sorento 4x4 & 4x2 2.5 & 3.5 gen 1 (JC) EXC elec or self-leveling susp	Front
PK338	KIA	07-Oct'09	Sorento 4x4 & 4x2 2.5 & 3.8 gen 1 (JC) EXC elec or self-leveling susp	Front
PK338	KIA	Nov'09 - '11	Sorento 4x4 & 4x2 gen 2 (XM). EXC elec or self-leveling susp	Front
PK338	KIA	12 - Feb'15	Sorento 4x2 gen 2 facelift (XM). EXC elec or self-leveling susp	Front
PK338	KIA	12 - Feb'15	Sorento 4x4 gen 2 facelift (XM). EXC elec or self-leveling susp	Front
PK339	MERCEDES-BENZ	98-March'02	 CLK320 & CLK430 Coupe (C208)	Front
PK339	MERCEDES-BENZ	98-03	 CLK320 & CLK430 Cabriolet (A208)	Front
PK339	MERCEDES-BENZ	Sept'00-April'07	C180, C180K, C200, C200K, C220Cdi, C230, C230K, C240, C280, C320Cdi, C350 & C270CDI (W203) INC , S/Wagon (C203) EXC AMG, Coupe & Sports susp	Front
PK339	MERCEDES-BENZ	Sept'00-April'07	W203 Sport Suspension EXC AMG	Front
PK339	MERCEDES-BENZ	00-11	C180K, C200K, C230K and CLC200K, CLC350 (CLC203) EXC Sport susp & AMG	Front
PK339	MERCEDES-BENZ	00-11	CLC203 Sport Suspension EXC AMG	Front
PK339	MERCEDES-BENZ	April'02-09	 CLK320, CLK350 & CLK500 Coupe (C209) EXC Sport & AMG	Front
PK339	MERCEDES-BENZ	02 - 09	 CLK320, CLK350 & CLK500 Cabriolet (A209) EXC Sport & AMG	Front
PK340	SUZUKI	14-16	Splash 1.2 hatch	Rear
PK340	SUZUKI	08-10	 Swift gen 1 (RS413, RS415, MZ, EZ) EXC AWD & Sport ZC31S	Rear
PK340	MERCEDES-BENZ	5/07-May'14	C180, C200, C220Cdi, C230, C250, C250Cdi, C280, C300, C320Cdi, C350Cdi & C350 EXC elec susp, Self level susp, AMG, Coupe, 4-Matic & Sports susp	Rear
PK342	MITSUBISHI	11-23	ASX SUV gen 1 (GA, W)	Front
PK342	MITSUBISHI	June '07-'12	Outlander 2.4 SUV (Gen 2, GS platform) CW5W INC '10-'12 Facelift models	Front
PK342	PEUGEOT	09-10	4007 SUV (VU, WV)	Front

Key





*	See important installation information on inside front cover
!	Excluding self-leveling suspension
"..."	Special order - phone 010 900 1850. 6-12 week waiting period

~	Imported
#	Internal bump stop
⊕	Steering damper

- It is recommended that all new shock absorbers are fitted in pairs
- Do not mix gas and non-gas units on the same axle
- **Bold** part numbers indicate heavy-duty shocks
- Underlined part numbers indicate parts not immediately available
- *Italic* part numbers followed by > indicate parts to be discontinued

Protection kits

Part number [numerical listing]

Part number	Make	Year	Application	Position
PK342	MITSUBISHI	07-16	Lancer 1.5, 2.0 EXC Evo (CY2A gen 9)	Front
PK343	SUZUKI	14-16	Splash 1.2 hatch	Front
PK343	SUZUKI	08-10	 Swift gen 1 (RS413, RS415, MZ, EZ) EXC AWD & Sport ZC31S	Front
PK344	HYUNDAI	01-08	Trajet 2.0d & 2.7 MPV (FO)	Front
PK344	HYUNDAI	01-06	Santa Fe 4x2 & 4x4 Gen 1 (SM)	Front
PK345	AUDI	07-March'15	TT 1.8T, 2.0T, 3.2 V6 Coupe & Roadster/Cabriolet, EXC Quattro & Sport susp (8J) EXC elec susp & 2.5RS Quattro (8J)	Front
PK346	HYUNDAI	02-10	Matrix Mini MPV (FC)	Front
PK347	HYUNDAI	10/05-9/10	Sonata (NF) gen 5	Front
PK348	PEUGEOT	06-08	1007 Harch 1.6	Front
PK349	SMART	03-07	ForTwo all 700cc EXC cabrio EXC Brabus (W450 gen 1)	Front
PK350	SMART	03-07	ForTwo all 700cc EXC cabrio EXC Brabus (W450 gen 1)	Rear
PK351	TOYOTA	05 - Sept'11	Yaris Hatch & (Vios) Sedan (NBC2) gen 2 (XP90)	Front
PK351	TOYOTA	Oct'11- 19	Yaris Hatch 1.0, 1.3 & Sedan gen 3 (XP130)	Front
PK352	RENAULT	09-14	Laguna III Coupe (X91)	Front
PK353 (Oval)	VOLKSWAGEN	04-Feb'09	Golf V EXC Gti, V5, R32 & Sport susp) 1K1. OE Strut leg bottom outer diam = 50mm	Rear
PK353 (Oval)	VOLKSWAGEN	March'09-13	Golf VI EXC Gti, V5, R32, AWD, Elec & Sport susp) OE Strut leg bottom outer diam = 50mm	Rear
PK353 (Oval)	VOLKSWAGEN	March'06-Sept'11	Jetta V EXC V5 & Sport susp) 1K2 (A5) Strut leg bottom outer diam = 50mm	Rear
PK353 (Oval)	VOLKSWAGEN	Oct'11-19	Jetta VI EXC V5 & Sport susp) 1B (A6) OE Strut leg bottom outer diam = 50mm	Rear
PK353 (Oval)	VOLKSWAGEN	Oct'11-19	Jetta VI EXC V5 & Sport susp) 1B (A6) OE Strut leg bottom outer diam = 55mm	Rear
PK355	ALFA ROMEO	10-20	Giulietta (940) All	Front
PK357	VOLKSWAGEN	13-23	Up hatch 1.0 EXC Cross	Front
PK358	BMW	April'14-on	2 Series Sport Susp (EXC elec susp & M2)	Front
PK361	CHEVROLET	09-18	Cruze J300 (gen one) & J400 (gen two) Sedan & Hatch EXC Sport susp, EXC OPC	Rear
PK362	PEUGEOT	02-12	206 S/Wagon 1.6, Cabrio cc	Front
PK363	AUDI	July'04-11	A6 Sedan & Avant EXC Quattro EXC Air susp) C6 Typ 4F	Front
PK366	MERCEDES-BENZ	06-June'10	Viano 7 seater MPV 2.2 Cdi, 3.0 Cdi, 3.5V6 EXC air susp (W639 gen 2)	Front
PK366	MERCEDES-BENZ	04-Aug'10	Vito Minibus & Van 109CDi, 111CDi, 115CDi, 119, 120CDi, 122, 123, 126 (3.5) RWD EXC air susp (W639 Gen 2)	Front
PK366	MERCEDES-BENZ	July'10-Sept '14	Viano 7 seater MPV 2.2 Cdi, 3.0 Cdi, 3.5V6 EXC air susp (W639 gen 2 facelift) EXC AWD	Front
PK366	MERCEDES-BENZ	Sept'10-Sept '15	Vito Van 113, 115, 116, 122 RWD EXC air susp (W639 Gen 2 facelift) EXC AWD	Front
PK368	HYUNDAI	10-March '16	iX35 4x2 (LM) gen 2	Front
PK368	HYUNDAI	10-March '16	iX35 4x4 (LM) gen 2	Front
PK368	KIA	Sept'10-March '16	Sportage 4x2 2.0, 2.4 Gen 3 (SL)	Front
PK368	KIA	Sept'10-March '16	Sportage 4x4 2.0, 2.4 Gen 3 (SL)	Front
PK369	HYUNDAI	09-'15	i20 Hatch (PB) gen 1 EXC facelift	Front
PK370	VOLVO	09-Sept 18	XC60 AWD Cross Country SUV gen 1 EXC elec & self leveling susp	Front
PK371	VOLKSWAGEN	13-23	Up hatch 1.0 EXC Cross	Rear
PK372	BMW	Nov'11-19	1 series 116i,118i, 120i, 125i & 120d (EXC Sport Susp, Elec susp, x-Drive, 135i, M135i & M140i)	Front
PK372	BMW	Nov'11-19	1 series Sport Susp (EXC elec susp, x-Drive, M135i & M140i)	Front
PK372	BMW	April'14-on	2 Series 220i, 228i, 230i, 220d (EXC elec susp, 235i, M235i, M240i, M2 & Sport Susp)	Front
PK372	BMW	13- Feb 18	 3 Series F30 sedan (EXC GT Gran Turismo 5 door liftback/hatch, S/W, Sport susp, Elec Susp, X-Drive and M series) Gen 6	Front
PK372	BMW	13- Feb 18	  3 Series F30 sedan Sport Susp & F31 S/W std & Sport EXC GT Gran Turismo 5 door liftback/hatch, and M series) Gen 6	Front

Key





*	See important installation information on inside front cover
!	Excluding self-leveling suspension
"..."	Special order - phone 010 900 1850. 6-12 week waiting period

~	Imported
#	Internal bump stop
⊕	Steering damper

- It is recommended that all new shock absorbers are fitted in pairs
- Do not mix gas and non-gas units on the same axle
- **Bold** part numbers indicate heavy-duty shocks
- Underlined part numbers indicate parts not immediately available
- *Italic* part numbers followed by > indicate parts to be discontinued

Protection kits

Part number [numerical listing]

Part number	Make	Year	Application	Position
PK372	BMW	13-on	F34 Gran Turismo GT 3 series 5 door liftback/hatch (30) Sedan, S/Wagon, Sport susp and M series)	Front
PK372	BMW	13-on	4 Series Coupe, Gran Coupe (liftback) & Cabriolet SDrive (30) Sport susp, M4, Elec susp & Grand Coupe XDrive)	Front
PK372	BMW	13-on	4 Series Coupe, Gran Coupe (liftback) & Cabriolet Sport susp SDrive (30) elec susp, XDrive & M4)	Front
PK372	BMW	13-on	M4 Coupe, Cabriolet & GTS (M) Xdrive	Front
PK373	BMW	11-17	X3 (F25) 2.0i, 2.8i, 3.0i, 3.5i & 2.0d, 30d (M) Sport susp sDrive & xDrive AWD (30) elec susp)	Front
PK373	BMW	14-Sept 18	X4 (F26) 2.0i, 2.8i, 3.5i, 2.0d & 3.0d. (M) Sport susp xDrive AWD (30) elec susp & M40)	Front
PK374	BMW	June'10-16	All F10 5 Series sedan (M) Sport susp & M-Tech (30) GT liftback, F11 Touring S/W, elec susp & M5)	Front
PK374	BMW	June'10-16	All F07 Gran Turismo GT 5 Series Liftback (30) Sedan, F11 Touring S/W, xDrive & M5)	Front
PK376	BMW	11-17	X3 (F25) 2.0i, 2.8i, 3.0i, 3.5i & 2.0d, 30d (M) Sport susp sDrive & xDrive AWD (30) elec susp)	Rear
PK376	BMW	14-Sept 18	X4 (F26) 2.0i, 2.8i, 3.5i, 2.0d & 3.0d. (M) Sport susp xDrive AWD (30) elec susp & M40)	Rear
PK377	BMW	June'10-16	All F10 5 Series sedan (M) Sport susp & M-Tech (30) GT liftback, F11 Touring S/W, elec susp & M5)	Rear
PK379	BMW	13-on	F34 Gran Turismo GT 3 series 5 door liftback/hatch (30) Sedan, S/Wagon, Sport susp and M series)	Rear
PK379	BMW	Nov'11-19	1 series 116i,118i, 120i, 125i & 120d (M) Sport Susp (30) elec susp, x-Drive, 135i, M135i & M140i)	Rear
PK379	BMW	Nov'11-19	1 series 116i,118i, 120i, 125i & 120d (M) Sport Susp (30) elec susp, x-Drive, 135i, M135i & M140i)	Rear
PK379	BMW	April'14-on	2 Series 220i, 228i, 230i, 220d (30) elec susp, 235i, M235i, M240i, M2 & Sport Susp)	Rear
PK379	BMW	April'14-on	2 Series Sport Susp (30) elec susp & M2)	Rear
PK379	BMW	13- Feb 18	 3 Series F30 sedan (30) GT Gran Turismo 5 door liftback/hatch, S/W, Sport susp, Elec Susp, X-Drive and M series) Gen 6	Rear
PK379	BMW	13- Feb 18	  3 Series F30 sedan Sport Susp & F31 S/W std & Sport (30) GT Gran Turismo 5 door liftback/hatch, and M series) Gen 6	Rear
PK379	BMW	13-on	4 Series Coupe, Gran Coupe (liftback) & Cabriolet SDrive (30) Sport susp, M4, Elec susp & Grand Coupe XDrive)	Rear
PK379	BMW	13-on	4 Series Coupe, Gran Coupe (liftback) & Cabriolet Sport susp SDrive (30) elec susp, XDrive & M4)	Rear
PK379	BMW	13-on	M4 Coupe, Cabriolet & GTS (M) Xdrive	Rear
PK379 (Elec susp)	BMW	March 19-on	 3 Series G20 sedan (30) GT Gran Turismo 5 door liftback/hatch, S/W, Sport susp, Elec Susp, X-Drive and M series) Gen 7	Rear
PK379 (Elec susp)	BMW	March 19-on	 3 Series G20 sedan Sport Susp (30) GT Gran Turismo 5 door liftback/hatch, and M series) Gen 7	Rear
PK381	HYUNDAI	09-'12	i20 Hatch (PB) gen 1	Rear
PK381	HYUNDAI	13-Jan'15	i20 Hatch (PB) gen 1 – facelift	Rear
PK381	KIA	Nov'11-May 17	Rio 1.2, 1.4, 1.6 gen 3 (UB)	Rear
PK381	HYUNDAI	Aug'11-20	  Accent IV i25 (RB)	Rear
PK381	LAND ROVER	98-'01	Freelander 1.8 & 2.0D (30) 2.5 V6 (L314)	Front
PK381	LAND ROVER	01-March'07	Freelander All (M) 2.5 V6 (L314)	Front
PK383	MERCEDES-BENZ	12-Aug 18	A180, A200, A200d, A220d, A250 (W176) (30) AMG & Sport susp	Front
PK383	MERCEDES-BENZ	April'12-18	B180, B200, B200d, B220d, B250 (W246)	Front
PK383	MERCEDES-BENZ	13-19	CLA200, CLA200d, CLA220d, CLA250 (C117) (M) Sport susp, (30) Incr ground clearance, AMG & Elec susp	Front
PK383	MERCEDES-BENZ	14-19	GLA200, GLA200d, GLA220d, GLA250. (30) elec susp & AMG gen 1 (X156)	Front
PK385	CHERY	08-on	QQ3 (S11) 0.8, 1.1	Rear
PK385	CHEVROLET	03-05	Spark (M100, M150)	Rear
PK385	CHEVROLET	05-July'10	Spark (M200, M250) (M) Lite 2010-on	Rear
PK385	CHEVROLET	Aug'10-17	Spark LITE (M200, M250)	Rear
PK386	TOYOTA	01- Feb'06	RAV4 (ACA20,21 / ZCA 25, 26 / XA20) gen 2	Front
PK388	SMART	08-14	ForTwo all 1.0 (M) cabrio (30) Brabus (W451 gen 2)	Front
PK389	LAND ROVER	98-'01	Freelander 1.8 & 2.0D (30) 2.5 V6 (L314)	Rear
PK389	LAND ROVER	01-March'07	Freelander All (M) 2.5 V6 (L314)	Rear

Key

*	See important installation information on inside front cover
!	Excluding self-leveling suspension
***	Special order – phone 010 900 1850. 6-12 week waiting period

~	Imported
#	Internal bump stop
⊕	Steering damper

- It is recommended that all new shock absorbers are fitted in pairs
- Do not mix gas and non-gas units on the same axle
- **Bold** part numbers indicate heavy-duty shocks
- Underlined part numbers indicate parts not immediately available
- *Italic* part numbers followed by > indicate parts to be discontinued

Protection kits

Part number [numerical listing]

Part number	Make	Year	Application	Position
PK391	AUDI	11-19	A6 Sedan & Avant MC Quattro EX Air & Elec susp) C7 Typ 4G	Front
<u>PK392</u>	RENAULT	13-19	Captur 0.9T, 1.2T, 1.5dci crossover SUV gen 1 (J87, J5, H5)	Front
PK392	RENAULT	April'13-19	Clio 0.9, 1.2 EX Sport susp, RS)	Front
<u>PK396</u>	PEUGEOT	09-10	4007 SUV (VU, W)	Rear
PK396	MITSUBISHI	11-23	ASX SUV gen 1 (GA, W)	Rear
PK396	MITSUBISHI	June '07-'12	Outlander 2.4 SUV (Gen 2, GS platform) CW5W MC '10-'12 Facelift models	Rear
PK398	VOLVO	10-18	S60 Sedan, gen 2 EX elec susp	Rear
PK399	FORD	15-early18	Focus hatch MkIII facelift 2.0ST (I &3) & 2.3RS only	Front
PK399	FORD	Aug'11-15	Focus hatch MkIII 2.3RS AWD only	Front
PK399	FORD	15-early18	Focus (facelift) 1.0, 1.5, 1.6, 2.0Si, 2.0TDCi, TDCi Si, MC 2.0ST front only, Hatch and Sedan MkIII C346 facelift EX 2.0 ST rear & RS)	Front
PK404	MERCEDES-BENZ	Aug'11-18	CLS250 CLS350d, CLS400, CLS500 (W218) EX AMG)	Rear
PK405	MERCEDES-BENZ	Aug'11-18	CLS250 CLS350d, CLS400, CLS500 (W218) EX AMG)	Front
<u>PK406</u>	MERCEDES-BENZ	05-12	A170, A180CDi, A200 (W169)	Rear
<u>PK406</u>	MERCEDES-BENZ	06-March'12	B170, B200T, B200CDi (W245)	Rear
PK407	MINI	01-06	Mini One, Cooper, Cooper S, One D (R50, R52, R53 Mk I)	Rear
PK408	MINI	07-13	Mini One, Cooper, Cooper D, Cooper S, One D (R56,R57 Mk II) MC cabriolet (R57) & sport	Rear
PK408	MINI	08-14	Mini Clubman S/Wagon MC sport (R55) mkl	Rear
PK408	MINI	11-16	Mini Countryman SUV Crossover MC AWD (R60) mkl	Rear
PK408	MINI	11-15	Mini Coupe (R58) & Roadster Cabriolet (R59)	Rear
PK408	MINI	13-16	Mini Paceman 2 door crossover (R61)	Rear
PK410	PEUGEOT	Oct'12-20	208 1All gen 1 (A9)	Front
PK410	CITROEN	16-on	C3 III (SX, SY)	Front
PK410	CITROEN	19-on	C3 Aircross SUV 1, 2, 1, 6 (2R, 2C)	Front
PK410	OPEL	17-on	Crosland & Crosland X 1,2T SUV (P17)	Front
PK414	VOLVO	02-July'15	XC90 AWD 2.4D, 3.2, 4.4 V8 Cross Country S/Wagon gen 1 EX Elec or self lev susp)	Front
<u>PK415</u>	TOYOTA	07-March'13	Auris 1.4, 1.6, 1.8, 2.0 hatch (E150 / 330N) EX TRD	Rear
<u>PK415</u>	TOYOTA	April'13-19	Auris (E180)	Rear
<u>PK415</u>	TOYOTA	Feb 14-19	 Corolla Sedan 1.3, 1.4D, 1.6, 1.8 gen 11 "Profesional" EX Quest (E170 / E180)	Rear
<u>PK415</u>	TOYOTA	14-19	 Corolla QUEST 1.6 gen 10 (E140, E150)	Rear
<u>PK415</u>	TOYOTA	Feb 19-on	 Corolla QUEST 1.8, gen 11 (E170./ E180)	Rear
<u>PK420</u>	MERCEDES-BENZ	June'14-June '21	W205 C class C180, C200, C220d, C250, C250d, C300 & C350e EX S/Wagon, Elec susp, Self level susp, Coupe, 4-Matic, AMG & Sports susp)	Front
<u>PK420</u>	MERCEDES-BENZ	End '14-June '21	C Class Coupe C180, C200, C220d, C250, C250CDi, C300, C350 EX Sport susp & AMG)	Front
<u>PK420</u>	MERCEDES-BENZ	End '14-June '21	C Class Cabrio C200, C220d, C300 EX Sport susp & AMG)	Front
PK421	BMW	April'14-17	2 Series Active Tourer MPV 218i, 220i, 225i, 220d EX MTech & Sport Susp)	Front
PK422	VOLKSWAGEN	Sept'15-19	Passat sedan EX elec susp) (B8)	Front
PK422	AUDI	June 18 - on	A1 Sportback Gen 2 (GB) 30TFSI (1,0), 35TFSI (1,5), 40TFSI (2,0) EX Sport susp	Front
PK422	AUDI	Late '12-20	A3 all Gen 3 (8V) MC Sportback, Quattro, Sport Susp EX S3 & Elec susp). OE Strut leg outer diam = 50mm	Front
PK422	AUDI	Late '12-20	A3 all Gen 3 (8V) MC Sportback, Quattro, Sport Susp EX S3 & Elec susp). OE Strut leg outer diam = 55mm	Front
PK422	AUDI	12-on	A3 Cabriolet MC Quattro Gen 3 (8V)	Front
PK422	AUDI	17 - 23	Q2 (35) 1.0, 1.4 (GAB & GAG)	Front
PK422	VOLKSWAGEN	Oct'12-17	New Beetle (Type 2 / A5) 50mm front strut body	Front

Key

*	See important installation information on inside front cover
!	Excluding self-levelling suspension
"..."	Special order - phone 010 900 1850. 6-12 week waiting period

~	Imported
#	Internal bump stop
⊕	Steering damper

- It is recommended that all new shock absorbers are fitted in pairs
- Do not mix gas and non-gas units on the same axle
- **Bold** part numbers indicate heavy-duty shocks
- Underlined part numbers indicate parts not immediately available
- *Italic* part numbers followed by > indicate parts to be discontinued

Protection kits

Part number [numerical listing]

Part number	Make	Year	Application	Position
PK422	VOLKSWAGEN	Oct'12-17	New Beetle (Type 2 / A5) 55mm front strut body	Front
PK422	VOLKSWAGEN	13-19	Golf VII EXC! Gti, V5, R, AWD & Sport susp) (5G) EXC! elec susp) OE Strut leg outer diam = 50mm	Front
PK422	VOLKSWAGEN	13-19	Golf VII INC! Gti EXC! V5, R, AWD & Sport susp) (5G) EXC! elec susp) OE Strut leg outer diam = 55mm	Front
PK422	VOLKSWAGEN	15-17	Golf SV (Sportsvan) MPV EXC! elec susp)	Front
PK422	VOLKSWAGEN	Feb '18 - on (Gti from June '18)	 Polo Hatch, EXC! Vivo, Sedan & Cross (mk 6, model AW)	Front
PK422	VOLKSWAGEN	20 - on	 Polo 1.6 Sedan (mk 5 facelift)	Front
PK422	VOLKSWAGEN	19-on	T-Cross SUV (C11)	Front
PK422	VOLKSWAGEN	20-on	T-Roc SUV EXC! electronic susp (A11)	Front
PK422	VOLKSWAGEN	Oct 16-23	Tiguan 4-Motion AWD & FWD 1.4TSi, 2.0 Tdi, 2.0TSi gen 2 INC! Allspace 7 seater (AD, BW) EXC! electronic suspension	Front
PK424	VOLKSWAGEN	Sept'15-19	Passat sedan EXC! elec susp) (B8)	Rear
PK424	VOLKSWAGEN	Oct 16-23	Tiguan 4-Motion AWD & FWD 1.4TSi, 2.0 Tdi, 2.0TSi gen 2 INC! Allspace 7 seater (AD, BW) EXC! electronic suspension	Rear
PK424	AUDI	Oct 18 - on	Q3 1.4, 2.0 4x2 & 4x4 Quattro EXC! RS 2.5 sport or elec susp) F3	Rear
PK424	VOLKSWAGEN	18-22	Arteon 4 door Sport coupe (3H7) Std suspension	Rear
PK424	VOLKSWAGEN	13-19	Golf VII EXC! Gti, V5, R, AWD & Sport susp) (5G) EXC! elec susp) OE Strut leg outer diam = 50mm	Rear
PK424	VOLKSWAGEN	13-19	Golf VII INC! Gti EXC! V5, R, AWD & Sport susp) (5G) EXC! elec susp) OE Strut leg outer diam = 55mm	Rear
PK424	VOLKSWAGEN	15-17	Golf SV (Sportsvan) MPV EXC! elec susp)	Rear
PK424	VOLKSWAGEN	15-17	Golf SV (Sportsvan) MPV EXC! elec susp)	Rear
<u>PK424</u>	VOLKSWAGEN	20-on	T-Roc SUV EXC! electronic susp (A11)	Rear
PK426	FIAT	15-on	500X 1.4, 1.6 5 door Cross over SUV (FWD)	Front
PK426	FIAT	15-on	500X 1.4, 1.6 5 door Cross over SUV (AWD)	Front
PK426	JEEP	15-on	Jeep Renegade (BU) SUV 4x2	Front
PK426	JEEP	15-on	Jeep Renegade (BU) SUV 4x4	Front
<u>PK427</u>	FIAT	15-on	500X 1.4, 1.6 5 door Cross over SUV (FWD)	Rear
<u>PK427</u>	FIAT	15-on	500X 1.4, 1.6 5 door Cross over SUV (AWD)	Rear
PK427	JEEP	15-on	Jeep Renegade (BU) SUV 4x2	Rear
PK427	JEEP	15-on	Jeep Renegade (BU) SUV 4x4	Rear
PK428	FIAT	11-22	Panda 0.9, 1.2 EXC! AWD & 1.4 100HP) (319) mk4	Front
PK428	FIAT	11-22	Panda 0.9, 1.2 Climbing / Cross AWD EXC! 1.4 100HP) (319) mk4	Front
PK429	NISSAN	11-19	Juke FWD (F15)	Front
PK429	NISSAN	11-19	Juke AWD (F15)	Front
PK430	NISSAN	11-19	Juke FWD (F15)	Rear
PK430	NISSAN	11-19	Juke AWD (F15)	Rear
PK431	OPEL	14-19	Adam 1.0T, 1.4 INC! "S" (M13)	Rear
PK431	OPEL	Nov'15-19	Corsa Hatch 1.0T, 1.4 INC! 1.4 Turbo Sport (E)	Rear
PK434	OPEL	18-on	Grandland & Grandland X 1,6T SUV (A18)	Front
PK434	PEUGEOT	14-21	 308 1.2T gen 2 (T9)	Front
PK434	PEUGEOT	17-on	3008 MPV 1.2T, 1.6T, 2.0 Hdi Crossover gen 2 EXC! self leveling susp) (P84 / MC, MR, MJ, M4)	Front
PK434	PEUGEOT	17-on	5008 1.6T MPV gen 2 (P87, MC, MJ, MR, M4)	Front
PK435	FORD	13-22	Tourneo Custom 8 seater minibus & Transit Custom van (V36X, F3, FY, FZ) FWD	Front
PK435	FORD	13-22	Tourneo Custom 8 seater minibus & Transit Custom van (V36X, F3, FY, FZ) FWD	Front
PK435	FORD	13-22	Tourneo Custom 8 seater minibus & Transit Custom van (V36X, F3, FY, FZ) FWD	Front

Key







*	See important installation information on inside front cover
!	Excluding self-levelling suspension
***	Special order - phone 010 900 1850. 6-12 week waiting period

~	Imported
#	Internal bump stop
⊕	Steering damper

- It is recommended that all new shock absorbers are fitted in pairs
- Do not mix gas and non-gas units on the same axle
- **Bold** part numbers indicate heavy-duty shocks
- Underlined part numbers indicate parts not immediately available
- *Italic* part numbers followed by > indicate parts to be discontinued

Protection kits

Part number [numerical listing]

Part number	Make	Year	Application	Position
PK435	FORD	13-on	Transit van and Bus MC chassis cab, Gen 4 (V363, FDC, FDD, FED, FFD) RWD	Front
PK435	FORD	13-on	Transit van and Bus MC chassis cab, Gen 4 (V363, FDC, FDD, FED, FFD) RWD	Front
PK435	FORD	13-on	Transit van and Bus MC chassis cab, Gen 4 (V363, FDC, FDD, FED, FFD) RWD	Front
PK438	TOYOTA	Feb 14-19	 Corolla Sedan 1.3, 1.4D, 1.6, 1.8 gen 11 "Professional" EXC Quest (E170 / E180)	Front
PK438	TOYOTA	Feb 19-on	 Corolla QUEST 1.8, gen 11 (E170./E180)	Front
PK441	KIA	03-06	Sorento 4x4 & 4x2 2.5 & 3.5 gen 1 (JC) EXC elec or self-leveling susp	Rear
PK441	KIA	07-Oct'09	Sorento 4x4 & 4x2 2.5 & 3.8 gen 1(JC) EXC elec or self-leveling susp	Rear
PK442	AUDI	Late '12-20	A3 all Gen 3 (8V) MC Sportback, Quattro, Sport Susp EXC S3 & Elec susp). OE Strut leg outer diam = 50mm	Rear
PK442	AUDI	Late '12-20	A3 all Gen 3 (8V) MC Sportback, Quattro, Sport Susp EXC S3 & Elec susp) OE Strut leg outer diam = 55mm	Rear
PK442	AUDI	12-on	A3 Cabriolet MC Quattro Gen 3 (8V)	Rear
PK443	FORD	13-'19	Kuga 4x2 & 4x4 SUV (gen 2) DM2, C520	Rear
PK444	FORD	13-'19	Kuga 4x2 & 4x4 SUV (gen 2) DM2, C520	Front
PK445	HYUNDAI	03-11	Getz (TB)	Rear
PK446	PEUGEOT	Oct'12-19	208 1.0, 1.2T, 1.4, 1.6 Type 1, 2 & 3 susp (check front strut lower outer diameter) gen 1 (A9)	Rear
PK446	PEUGEOT	Oct'12-19	208 1.4 Hdi, 1.6 GTi, 1.6 Hdi Type 3 susp (check front strut lower outer diameter & brake hose bracket) gen 1 (A9)	Rear
PK446	PEUGEOT	Oct'12-20	208 1.4 Hdi, 1.6 16v Turbo GTi, 1.6 Hdi Type 4 susp (check front strut lower outer diameter & brake hose bracket) gen 1 (A9)	Rear
PK447	CHEVROLET	09-18	Cruze J300 (gen one) & J400 (gen two) Sedan & Hatch MC Sport susp, EXC OPC	Front
PK447	OPEL	end 10-May 16	Astra EXC OPC, GTC, Elec susp) (J)	Front
PK448	VOLKSWAGEN	04 - May 15	Caddy All gen 3 (2K) (check front strut OD for correct part) 50mm OD strut tube	Rear
PK448	VOLKSWAGEN	June 15-Oct '21	Caddy All gen 3, (2K Facelift)	Rear
<u>PK453</u>	RENAULT	April'13-19	Clio 0.9, 1.2 EXC Sport susp, RS)	Rear
<u>PK453</u>	RENAULT	April'13-19	Clio 1.6 RS Sport	Rear
PK455	FIAT	11-22	Panda 0.9, 1.2 EXC AWD & 1.4 100HP) (319) mk4	Rear
<u>PK455</u>	FIAT	11-22	Panda 0.9, 1.2 Climbing / Cross AWD EXC 1.4 100HP) (319) mk4	Rear
PK457	FIAT	July'06-on	  Ducato SWB & LWB Van & Minibus (Q11, Q15, Q17, Q20) Gen 3	Rear
PK457	FIAT	July'06-on	  Ducato SWB & LWB Van & Minibus (Q11, Q15, Q17, Q20) Gen 3	Rear
<u>PK457</u>	PEUGEOT	April '06-on	Boxer 2.2 Hdi, 3.0 Hdi Van LWB gen 3 (12Q, 14Q, 16Q, 20Q) 3.3 & 4.0 ton EXC 4x4)	Rear
PK457	FIAT	July'06-on	  Ducato SWB & LWB Van & Minibus (Q11, Q15, Q17, Q20) Gen 3	Rear
PK459	CITROEN	04-11	C2 1.1i, 1.4i, 1.6i EXC Sport Susp) (JM)	Rear
PK459	CITROEN	02-May'06	C3 1.4i, 1.6i manual. EXC 1.6 auto, Hdi 80kw & 82kw 51mm OD strut base (FC / FN)	Rear
PK459	CITROEN	02-May'06	C3 1.6i 16v auto & Hdi 80kw & 82kw EXC 46mm OD strut base. (FC / FN)	Rear
PK459	CITROEN	June'06-Nov'09	C3 (facelift) 1.4, 1.6 (FC / FN)	Rear
PK459	CITROEN	02-09	 C3 Pluriel & Enterprise models – Convertible (HB)	Rear
PK460	ALFA ROMEO	10-20	Giulietta (940) All	Rear
PK461	HYUNDAI	June'14-July '20	Grand i10 Hatch 1,25 gen 2 (BA)	Front
PK465	MINI	14-24	Mini One, Cooper (F56 – 3 door, F55 – 5 door Mk III) MC cabriolet (F57) & sport EXC JCW GP sport)	Front
PK466	MINI	14-24	Mini One, Cooper (F56 – 3 door, F55 – 5 door Mk III) MC cabriolet (F57) & sport EXC JCW GP sport)	Rear
<u>PK467</u>	FORD	17-22	 Fiesta Sedan & Hatch Mk 7 HJ, HF	Front
PK468	AUDI	Oct 18 - on	Q3 1.4, 2.0 4x2 & 4x4 Quattro EXC RS 2.5 sport or elec susp) F3	Front
PK469	BMW	15-on	i3 Hatch urban electric vehicle (i01)	Front
PK471	AUDI	18 - on	Q5 4x4 Quattro EXC sport susp, S or HD) FY (elec susp)	Front

Key

*	See important installation information on inside front cover
!	Excluding self-leveling suspension
"..."	Special order – phone 010 900 1850. 6-12 week waiting period

~	Imported
#	Internal bump stop
⊕	Steering damper

- It is recommended that all new shock absorbers are fitted in pairs
- Do not mix gas and non-gas units on the same axle
- **Bold** part numbers indicate heavy-duty shocks
- Underlined part numbers indicate parts not immediately available
- *Italic* part numbers followed by > indicate parts to be discontinued

Protection kits

Part number [numerical listing]

Part number	Make	Year	Application	Position
PK471	AUDI	Feb 16-on	 A4 Sedan MC Quattro (8W) EX Sport susp & S4 B9 (53mm btm mtng housing diam)	Front
PK471	AUDI	Feb 16-on	 A4 Sedan MC Quattro (8W) Sport susp EX S4 B9 (48mm btm mtng housing diam)	Front
PK471	AUDI	Feb '16 - on	A5 Sportback Coupe, Cabrio & Quattro EX RS5) (F5, B9)	Front
PK471	AUDI	Feb 16 - on	S5 Sportback Coupe & Cabrio MC A5 Sport Susp, Quattro EX RS5 4.2 V8 (B9)	Front
PK474	AUDI	18 - on	Q5 4x4 Quattro EX sport susp, S or HD) FY (std susp)	Front
PK475	BMW	April'14-17	2 Series Active Tourer MPV 218i, 220i, 225i, 220d EX MTEch & Sport Susp)	Rear
PK476	BMW	Nov 15-Oct 22	X1 (F48) sDrive FWD & xDrive AWD 1.8i, 2.0i, 2.0d EX LWB F49)	Rear
PK476	BMW	Nov 18-on	X2 (F39) 1.8i, 2.0i sDrive FWD & 2.0d xDrive AWD	Rear
PK477	BMW	Nov 15-Oct 22	X1 (F48) sDrive FWD & xDrive AWD 1.8i, 2.0i, 2.0d EX LWB F49)	Front
PK477	BMW	Nov 18-on	X2 (F39) 1.8i, 2.0i sDrive FWD & 2.0d xDrive AWD	Front
PK477	MINI	15-24	Mini Clubman S/Wagon MC sport (F54) mkII	Front
PK477	MINI	April 17-on	Mini Countryman SUV Crossover MC AWD (F60) mkII	Front
PK478	MINI	April 17-on	Mini Countryman SUV Crossover MC AWD (F60) mkII	Rear
PK479	MINI	11-16	Mini Countryman SUV Crossover MC AWD (R60) mkl	Front
PK479	MINI	13-16	Mini Paceman 2 door crossover (R61)	Front
PK480	OPEL	11-18	Astra GTC coupe MC OPC (J)	Rear
SA1999 Protective boot	JEEP	86- 96	Jeep Wrangler 4x4 (YJ series) Steering Damper ⊕	Front
SA1999 Protective boot	JEEP	97-06	Jeep Wrangler 4x4 (TJ series) MC Sport Steering Damper ⊕	Front
SA1999 Protective boot	JEEP	07-18	Jeep Wrangler 4x4 (JK series) 2 & 4 door MC Rubicon & Unlimited Steering Damper ⊕	Front
SA1999 Protective boot	TOYOTA	79-84	Hilux 4x4 N30, N40) Steering Damper ⊕	Front
SA1999 Protective boot	TOYOTA	84-End'98	Hilux All 4x4 (N505, N60) Steering Damper ⊕	Front
SA1999 Protective boot	TOYOTA	End 98-May'05	Hilux P690 All 4x4 & raised body 4x2 MC Raider IFS gen 6 Steering Damper ⊕	Front
SA1999 Protective boot	TOYOTA	90-98	Landcruiser 80 series S/Wagon (MC certain solid axle 105 series '98-'07 models) Steering Damper ⊕	Front
SA1999 Protective boot	TOYOTA	72-86	Landcruiser 40 series LDV leaf springs Steering Damper ⊕	Front
SA1999 Protective boot	TOYOTA	87- 99	Landcruiser HZJ75 series LDV leaf springs Steering Damper ⊕	Front
SA1999 Protective boot	TOYOTA	99-07 only	Landcruiser HZJ79 series LDV Rear leaf springs, Coil front Steering Damper ⊕	Front
SA1999 Protective boot	JEEP	99-5/05	Jeep Grand Cherokee All (WJ series) (MC Up country susp) Steering Damper ⊕	Front
SA1999 Protective boot	SUZUKI	81- 87	SJ410, SJ413, SJ413-4, (leaf spring susp), MC Samurai 4X4 Steering Damper ⊕	Front
SA1999 Protective boot	SUZUKI	88-04	Samurai SJ413, 4X4 (Leaf spring susp) Steering Damper ⊕	Front

Key



















*	See important installation information on inside front cover
!	Excluding self-levelling suspension
"..."	Special order - phone 010 900 1850. 6-12 week waiting period

~	Imported
#	Internal bump stop
⊕	Steering damper

- It is recommended that all new shock absorbers are fitted in pairs
- Do not mix gas and non-gas units on the same axle
- **Bold** part numbers indicate heavy-duty shocks
- Underlined part numbers indicate parts not immediately available
- *Italic* part numbers followed by > indicate parts to be discontinued

Mounting kits

Part number [numerical listing]

Part number	Make	Year	Application	Position
905902MMR & 905903MML	JEEP	02-07	Jeep Cherokee 4x4 (KJ)	Front
905902MMR & 905903MML	JEEP	08-13	Jeep Cherokee 4x4 (KK)	Front
906959MM	JEEP	07-10	Compass (MK) gen1	Rear
906959MM	JEEP	11-16	Compass (MK2) gen 1 Facelift	Rear
906959MM	JEEP	07-10	Patriot 4x4 (MK)	Rear
906959MM	JEEP	11-18	Patriot (MK2) (Facelift)	Rear
907994MM	JEEP	07-10	Compass (MK) gen1	Front
907994MM	JEEP	11-16	Compass (MK2) gen 1 Facelift	Front
907994MM	JEEP	07-10	Patriot 4x4 (MK)	Front
907994MM	JEEP	11-18	Patriot (MK2) (Facelift)	Front
908916MML & 908917MMR	NISSAN	Aug'06 -13	Tiida 1.6 & 1.8 Hatch / Sedan gen 1 (X11C)	Front
MK001	PEUGEOT	06-08	1007 Harch 1.6	Front
MK001	HYUNDAI	02-08	Tiburon Coupe (GK)	Front
MK001	KIA	06-12	Carens MPV (UN)	Front
MK001 (bearing only)	PEUGEOT	06-12	207 All	Front
MK001 (bearing only)	CITROEN	96-02	Berlingo Multispace MPV & P/Van	Front
MK001 (bearing only)	CITROEN	03-April'08	Berlingo Multispace MPV & P/Van	Front
MK001 (bearing only)	CITROEN	Dec'09-16	C3 II (EXCL DS3 & Sport) (SC) 46mm & 51mm OD strut base	Front
MK001 (bearing only)	CITROEN	16-on	C3 III (SX, SY)	Front
MK001 (bearing only)	CITROEN	10-13	C3 Picasso	Front
MK001 (bearing only)	PEUGEOT	Nov'02-08	Partner Grand Raid MPV 1.9D (DWBB) & 2.0 Hdi (DW10TD) gen 1 (600kg payload) (5F)	Front
MK001 (bearing only)	RENAULT	Mid 83-86	R9 & R11 All	Front
MK001 (bearing only)	RENAULT	96-'00	Safrane	Front
MK001 (bearing only)	CITROEN	June'06-Nov'09	C3 (facelift) 1.4, 1.6 (FC / FN)	Front
MK001 (bearing only)	PEUGEOT	99-Nov'02	Partner Grand Raid MPV 2.0 Hdi (DW10TD) gen 1 (600kg payload) (5F)	Front
MK001 (bearing only)	PEUGEOT	99-11/02	Partner Panel Van 1.9D gen 1 (800kg payload)	Front
MK001 (bearing only)	PEUGEOT	11/02-08	Partner Panel Van 1.9D gen 1 (800kg payload)	Front
MK001 (bearing only)	HYUNDAI	09-June'12	i30 Hatch (FD) gen 1	Front
MK001 (bearing only)	KIA	09-12	Cee'd hatch 2.0 3-door (ED)	Front
MK001 (bearing only)	RENAULT	95-'02	 Megane Hatch 2.0 16v (EXCL Sedan)	Front
MK001 (bearing only)	RENAULT	96-May'04	Megane Coupe 2.0 16v	Front
MK001 (bearing only)	RENAULT	97 - May'04	Megane Cabriolet 2.0 16v	Front
MK001 (bearings only)	PEUGEOT	08-14	308 Hatch, S/W & Cabrio. gen 1 (T7)	Front
MK001 (bearings only)	CITROEN	13-17	C4 Cactus crossover SUV	Front
MK001 (bearings only)	HYUNDAI	06-July'11	  Accent III (MC)	Front
MK001 (bearings only)	PEUGEOT	Oct'12-20	208 1All gen 1 (A9)	Front
MK001 (bearings only)	PEUGEOT	13-19	2008 Crossover SUV 1.2T, 1.6 gen 1 (CU / A94)	Front
MK001 (bearings only)	KIA	March'06-Oct'11	Rio 1.4, 1.6 gen 2 (JB)	Front
MK006	SAAB	94-98	900 Sedan & Convertible  turbo	Front
MK006	SAAB	97-'01	9.5 sedan & S/W	Front
MK017 ( bearings)	OPEL	96-02	Corsa Hatch & Notch (sedan)  CorsalITE&LiteSport (B)	Front
MK017 ( bearings)	OPEL	02-15	Corsa LITE & Lite Sport - old shape Corsa hatch (B)	Front
MK017 ( bearings)	OPEL	96-Late04	Corsa LDV	Front
MK017 ( bearings)	OPEL	98-02	Corsa Pronto Panel Van	Front
MK030	FIAT	90-'09	Uno ( raised body "Way" version from Brazil)	Front
MK032	AUDI	92-'01	80 / 100 / 500 Cabriolet	Front
MK033 ( bearings)	VOLKSWAGEN	85-93	Golf II & Jetta II	Front
MK033 ( bearings)	VOLKSWAGEN	92-94	Golf III & Jetta III ( VR6)	Front
MK033 ( bearings)	VOLKSWAGEN	93-'04	Golf III & IV Cabriolet ( 16" wheels)	Front
MK036	BMW	84-91	 318i, 320i, 323i & 325i (E30)  iS & cabrio (51mm strut OD)	Front
MK036	BMW	87-91	 325iS Evo I & II std and E30 Cabriolet (51mm strut OD)	Front
MK036	BMW	Mid 85-89	518, 520, 525, 525e, 528 & 535e (E28) ( M Tech)	Front

Key

















*	See important installation information on inside front cover
!	Excluding self-levelling suspension
"..."	Special order - phone 010 900 1850. 6-12 week waiting period

~	Imported
#	Internal bump stop
⊕	Steering damper

- It is recommended that all new shock absorbers are fitted in pairs
- Do not mix gas and non-gas units on the same axle
- **Bold** part numbers indicate heavy-duty shocks
- Underlined part numbers indicate parts not immediately available
- *Italic* part numbers followed by > indicate parts to be discontinued

Mounting kits

Part number [numerical listing]

Part number	Make	Year	Application	Position
MK036	BMW	Mid 90 - 95	5 Series (E34) Std. & Sport Susp EXCI M Tech & M5) Note: See the INFO column for front shock selection details. Check OE numbers	Front
MK036	BMW	6/82 - '90	628CSI, 635CSI (E24) EXCI elec suspension)	Front
MK036(ForMG318only)	BMW	88-95	5 Series (E34) EXCI Sport Susp, M Tech & M5) Note: See the INFO column for front shock selection details. Check OE #'s	Front
MK037	DAEWOO	95- 98	Cielo	Front
MK037	DAEWOO	96- 98	Espero	Front
MK037	DAEWOO	98-'03	Lanos T100	Front
MK037	OPEL	Mid 85-88	  Kadett & Monza Sedan "T car" (E) EXCI Gsi & Cabriolet	Front
MK037	OPEL	89-92	  Kadett & Monza Sedan EXCI Cub & Gsi 2.0 (F.W.D) "T car" (E)	Front
MK039	OPEL	93- Oct'99	  Kadett & Astra EXCI S/W 	Front
MK039	OPEL	93- Oct'99	[S/W] Astra Estate S/Wagon 	Front
MK043	AUDI	94-July'97	A6 Sedan & Avant Quattro EXCI Sport suspension & S6)	Front
MK043	AUDI	94-July'97	A6 & S6 4.2 Sedan & Avant Quattro Sport suspension EXCI S6)	Front
MK045	BMW	91-99	316i, 318i, 318is, 318tds, 320i, 323i, 325i, 325td, 325tds, 328i Imported & Local Strut. EXCI Cabrio. EXCI M. Tech. (E36)	Front
MK045	BMW	91-92	320i, 325i & 325td Imported EXCI M. Tech. (E36)	Front
MK045	BMW	90-99	E36 M Tech (BMW Motorsport)	Front
MK045	BMW	90-99	M3 (E36)	Front
MK045	BMW	93-99	 M3 (E36)	Front
MK045	BMW	93-99	 323i, 325i & 328i Cabriolet EXCI M Tech) (E36)	Front
MK045	BMW	97-'03	Z3 1.8, 1.9, 2.8 & 3.0 (E36) EXCI M-tech & M Coupe	Front
MK045	BMW	04-09	Z4 2.0, 2.5 & 3.0 EXCI M-Tech 3.2M & Sport susp)	Front
MK045	BMW	09-16	Z4 (E89) sDrive, 2.0i, 2.3i, 2.8i, 3.0i, 3.5i, 3.5iS, EXCI Sport susp & M-Tech)	Front
MK055 EXCI bearings)	FORD	00-06	Ikon sedan All	Front
MK055 EXCI bearings)	FORD	97- Mid 99	Fiesta EXCI Power steering) Mk4 (JA, JB)	Front
MK055 EXCI bearings)	FORD	Mid 99 - 03	Fiesta EXCI RSi) Mk4 facelift (JA, JB)	Front
MK055 EXCI bearings)	FORD	Mid 99 - 03	 Fiesta 3 door 1.6 RSi & ST sport with power steering Mk4 facelift (JA, JB)	Front
MK055 EXCI bearings)	FORD	05-09	Ka 1.3 Hatch	Front
MK055 EXCI bearings)	MAZDA	97- 99	121 Soho gen 4 (BE, JA, JB)	Front
MK055 EXCI bearings)	MAZDA	99 - 06	121 Soho gen 4 facelift (BE, JA, JB)	Front
MK063	MERCEDES-BENZ	83-94	190E EXCI Sportline (201 Series)	Front
MK063 EXCI bearings)	MERCEDES-BENZ	86-95	W124 EXCI E420, E500 EXCI all CE models C124 coupes, EXCI Self leveling susp, S/W, Sportline & V124 limo (W124)	Front
MK063 EXCI bearings)	MERCEDES-BENZ	86-95	S124 S/Wagon 230TE & 300TE EXCI sport susp	Front
MK067 EXCI bearings)	VOLKSWAGEN	95-99	Golf III & Jetta III EXCI Gti & Cti EXCI VR6)	Front
MK067 EXCI bearings)	VOLKSWAGEN	93-99	Golf III & Jetta III VR6	Front
MK067 EXCI bearings)	VOLKSWAGEN	98-Sept'02	Polo Playa Hatch & Classic Sedan (mk 3 6N) EXCI sport susp	Front
MK067 EXCI bearings)	VOLKSWAGEN	98-07	Sharan MPV (7M8, 7M9, 7M6)	Front
MK070 EXCI bearings)	VOLKSWAGEN	78-92	Golf I / Jetta I & Citi EXCI Fox, Cti, Shuttle Trippa & Cabriolet	Front
MK070 EXCI bearings)	VOLKSWAGEN	93-10	Citi - EXCI Sonic, Life, VeloCiti & Rox (Sealed Strut)	Front
MK070 EXCI bearings)	VOLKSWAGEN	98-10	Citi - Sonic, Life & VeloCiti Slight OE lowering EXCI Rox - shorter rear)	Front
MK070 EXCI bearings)	VOLKSWAGEN	81-09	Golf LDV EXCI old Caddy and Citi Pick-Up	Front
MK077	VOLKSWAGEN	99-Oct'12	New Beetle (Type 2)	Front
MK077	AUDI	11-May 18	A1 Gen 1 (8X) EXCI Sport susp (122 PS)	Front
MK077	AUDI	11-May '18	A1 Gen 1 (8X) Sport susp & 1.4 TFSi (185 PS)	Front
MK077	AUDI	98-April'03	A3 1.8 & 1.8T turbo, 1.9TDi EXCI Sport Susp, Quattro & S3)	Front
MK077	AUDI	98-April'03	A3 Sport Susp EXCI Quattro)	Front
MK077	AUDI	00-06	TT 1.8 Turbo Coupe & Roadster/Cabriolet (8N) EXCI Sport Susp & 3.2 V6 Quattro (8N)	Front
MK077 EXCI bearings)	VOLKSWAGEN	13-23	Up hatch 1.0 EXCI Cross	Front
MK077 EXCI bearings)	VOLKSWAGEN	Feb'10-Jan '18	 Polo Hatch, EXCI Vivo, Sedan & Cross (mk 5 model, 6R, 6C)	Front
MK077 EXCI bearings)	VOLKSWAGEN	Feb'10-19	 Polo Sedan, EXCI Vivo, Gti, hatch (mk 5 model, 6V2)	Front
MK077 EXCI bearings)	VOLKSWAGEN	Feb'10-Feb '18	  Polo VIVO (mk 4 9N3) EXCI Maxx	Front
MK077 EXCI bearings)	VOLKSWAGEN	March 18-on	 Polo VIVO (mk 5 model, 6R, 6C) EXCI Maxx	Front
MK077 EXCI bearings)	VOLKSWAGEN	10/02-1/10	CrossPolo & Vivo Maxx EXCI Sport Susp (mk 4 9N3)	Front
MK077 EXCI bearings)	VOLKSWAGEN	11-18	CrossPolo & Vivo Maxx EXCI Sport Susp (mk 5 6R)	Front
MK077 EXCI bearings)	VOLKSWAGEN	99-04 (Jetta till 2/06)	Golf IV & Jetta IV 1.6 only EXCI Estate S/W) 20mm rod	Front

Key















*	See important installation information on inside front cover
!	Excluding self-leveling suspension
"..."	Special order - phone 010 900 1850. 6-12 week waiting period

~	Imported
#	Internal bump stop
⊕	Steering damper

- It is recommended that all new shock absorbers are fitted in pairs
- Do not mix gas and non-gas units on the same axle
- **Bold** part numbers indicate heavy-duty shocks
- Underlined part numbers indicate parts not immediately available
- *Italic* part numbers followed by > indicate parts to be discontinued

Mounting kits

Part number [numerical listing]

Part number	Make	Year	Application	Position
MK077 (MKI bearings)	VOLKSWAGEN	99-04 (Jetta till 2/06)	Golf IV & Jetta IV 1.8, Gti Turbo, 1.9 Tdi, 2.0, 2.3 V5 (EXCI Estate S/W & 1.6) 22mm rod	Front
MK077 (MKI bearings)	VOLKSWAGEN	99-05	Golf IV 1.6 Estate S/Wagon	Front
MK077 (MKI bearings)	VOLKSWAGEN	00-05	Golf IV 1.9 Tdi Estate S/Wagon	Front
MK081	SAAB	87-97	9000CD, CS, CDE & CSE	Front
MK085	VOLVO	97- 98	V90 S/Wagon EXCI XC90 4WD Cross Country	Front
MK088	TOYOTA	98-06	Conquest Carri Panel Van	Front
MK088 (MKI bearings)	TOYOTA	89-96	  Corolla & Conquest MKI Twin Cam & 1800 F.W.D P140 (EE90, AE92, CE90)	Front
MK088 (MKI bearings)	TOYOTA	96-Oct'02	 Corolla Sedan P160 gen 7 MKI Rsi & Rxi (E100, AE101)	Front
MK088 (MKI bearings)	TOYOTA	96-June'06	 Conquest / Tazz (EE90, AE92)	Front
MK095	FIAT	08-on	500 0.9, 1.2, 1.4 (3 door) EXCI Abarth / sport susp, "L" & "X" models (312)	Front
MK095	FORD	09-10	Ka 1.3 Hatch	Front
MK095	FIAT	04-10	Panda 1.2, 1.3 (EXCI AWD & 1.4 100HP) (169)	Front
MK095	FIAT	11-22	Panda 0.9, 1.2 (EXCI AWD & 1.4 100HP) (319) mk4	Front
MK095	FIAT	11-22	Panda 0.9, 1.2 Climbing / Cross AWD (EXCI 1.4 100HP) (319) mk4	Front
MK095	FIAT	04-Feb'12	Punto 1.2, 1.3 JTD, 1.4 Hatch (MkII) (188)	Front
MK095	FIAT	04-05	Punto 1.8 HGT 1.6v 3 door Hatch, plus 1.4 Sport Susp (MkII) (188)	Front
MK096 (MKI bearings)	RENAULT	95-02	  Megane Hatch & '96-'03 Classic Sedan (EXCI 2.0 16v)	Front
MK096 (MKI bearings)	RENAULT	96-May04	Megane Coupe (EXCI 2.0 16v)	Front
MK096 (MKI bearings)	RENAULT	97 - May'04	Megane Cabriolet (EXCI 2.0 16v)	Front
MK096 (MKI bearings)	RENAULT	96-Feb'04	Scenic 1.4 & 1.6 Manual (EXCI RX4)	Front
MK096 (MKI bearings)	RENAULT	96- June'98	Scenic 1.6 Automatic, 1.9dCi, 2.0 (EXCI RX4)	Front
MK096 (MKI bearings)	RENAULT	June'98-Feb'04	Scenic 1.6 Automatic, 1.9dCi, 2.0 (EXCI RX4)	Front
MK097 (Power steering only)	PEUGEOT	97-2/04	 306 CC Cabrio	Front
MK100	RENAULT	08-13	Twingo hatch 1.2, 1.5TD, Gen 2, EXCI RS Sport (CNO)	Front
MK100	RENAULT	June'04-08 (Multix '01-09 (Express)	Kangoo 1 Multix 1.4 MPV people carrier (580kg payload, 2 rear torsion bars), and Kangoo 1 Express minivan 1.4 & 1.5dCi (750kg payload, 4 rear torsion bars) (EXCI 4x4)	Front
MK100 (MKI bearings)	RENAULT	99-13	Clio 1.2 MKI Va va vroom (EXCI 1.2 16v, 1.4 & 1.6, 2.0 & 3.0 V6)	Front
MK100 (MKI bearings)	RENAULT	99-06	Clio 1.2 16v, 1.4, 1.5dCi & 1.6 (EXCI Sport 1.6, 2.0 & 3.0)	Front
MK100 (MKI bearings)	RENAULT	99-06	Clio 1.6 16v Sport (EXCI 2.0 16v Sport & 3.0 V6 mid engine)	Front
MK112 (MKI bearings)	MERCEDES-BENZ	02-04	Vito Minibus & Van 112 & 113 FWD (W638 Gen 1)	Front
MK114 (MKI bearings)	FORD	03-Oct'04	Focus 1.6 Hatch & Sedan MkI DAW (EXCI 2.0 & ST170)	Front
MK114 (MKI bearings)	FORD	00-Oct'04	Focus 2.0 & ST170 Hatch and Sedan MkI	Front
MK118	AUDI	11-May 18	A1 Gen 1 (8X) EXCI Sport susp (122 PS)	Rear
MK118	AUDI	11-May '18	A1 Gen 1 (8X) Sport susp & 1.4 TFSi (185 PS)	Rear
MK118	AUDI	98-April'03	A3 1.8 & 1.8T turbo, 1.9TDi (EXCI Sport Susp, Quattro & S3)	Rear
MK118	AUDI	98-April'03	A3 Sport Susp (EXCI Quattro)	Rear
MK118	VOLKSWAGEN	99-Oct'12	New Beetle (Type 2)	Rear
MK118 (EXCI bearings)	VOLKSWAGEN	99-04 (Jetta till 2/06)	Golf IV & Jetta IV 1.6 only (EXCI Estate S/W) 20mm rod	Rear
MK118 (EXCI bearings)	VOLKSWAGEN	99-04 (Jetta till 2/06)	Golf IV & Jetta IV 1.8, Gti Turbo, 1.9 Tdi, 2.0, 2.3 V5 (EXCI Estate S/W & 1.6) 22mm rod	Rear
MK118 (EXCI bearings)	VOLKSWAGEN	Oct'02-Jan'10	Polo Hatch & Classic Sedan EXCI CrossPolo (mk 4 9N3)	Rear
MK118 (EXCI bearings)	VOLKSWAGEN	Feb'10-Jan '18	 Polo Hatch, EXCI Vivo, Sedan & Cross (mk 5 model, 6R, 6C)	Rear
MK118 (EXCI bearings)	VOLKSWAGEN	Feb'10-19	 Polo Sedan, EXCI Vivo, Gti, hatch (mk 5 model, 6V2)	Rear
MK118 (EXCI bearings)	VOLKSWAGEN	20 - on	 Polo 1.6 Sedan (mk 5 facelift)	Rear
MK118 (EXCI bearings)	VOLKSWAGEN	Feb'10-Feb '18	 Polo VIVO (mk 4 9N3) EXCI Maxx	Rear
MK118 (EXCI bearings)	VOLKSWAGEN	March 18-on	 Polo VIVO (mk 5 model, 6R, 6C) EXCI Maxx	Rear
MK118 (EXCI bearings)	VOLKSWAGEN	10/02-1/10	CrossPolo & Vivo Maxx EXCI Sport Susp (mk 4 9N3)	Rear
MK118 (EXCI bearings)	VOLKSWAGEN	11-18	CrossPolo & Vivo Maxx EXCI Sport Susp (mk 5 6R)	Rear
MK118 (Quattro)	AUDI	00-06	TT 1.8 Turbo Coupe & Roadster/Cabriolet (8N) EXCI Sport Susp & 3.2 V6 Quattro (8N)	Rear
MK120	BMW	84-91	 318i, 320i, 323i & 325i (E30) EXCI iS & cabrio (51mm strut OD)	Rear
MK120	BMW	87-91	 325iS Evo I & II std and E30 Cabriolet (51mm strut OD)	Rear
MK121	BMW	91-99	316i, 318i, 318is, 318tds, 320i, 323i, 325i, 325td, 325tds, 328i Imported & Local Strut. MKI Cabrio. (EXCI M. Tech). (E36)	Rear
MK121	BMW	91-92	320i, 325i & 325td Imported EXCI M. Tech. (E36)	Rear
MK121	BMW	90-99	E36 M Tech (BMW Motorsport)	Rear

Key









*	See important installation information on inside front cover
!	Excluding self-levelling suspension
...	Special order - phone 010 900 1850. 6-12 week waiting period

~	Imported
#	Internal bump stop
⊖	Steering damper

- It is recommended that all new shock absorbers are fitted in pairs
- Do not mix gas and non-gas units on the same axle
- **Bold** part numbers indicate heavy-duty shocks
- Underlined part numbers indicate parts not immediately available
- *Italic* part numbers followed by > indicate parts to be discontinued

Mounting kits

Part number [numerical listing]

Part number	Make	Year	Application	Position
MK121	BMW	90-99	M3 (E36)	Rear
MK121	BMW	93-99	 M3 (E36)	Rear
MK121	BMW	93-99	 323i, 325i & 328i Cabriolet (EXC M Tech) (E36)	Rear
MK121	BMW	99 - Sept'01	318i & 320d (E46) (EXC M3, cabrio, coupe, & sport susp)	Rear
MK121	BMW	99 - Sept'01	320i, 323i, 325i & 328i (E46) (EXC M3, cabrio, coupe & sport susp)	Rear
MK121	BMW	99 - April'01	330i & 330d (E46) (EXC M3, cabrio, coupe & sport)	Rear
MK121	BMW	Sept'01 - Feb'05	318i (E46) (EXC Compact, M3, cabrio, coupe, sport susp & S/W)	Rear
MK121	BMW	Sept'01 - Feb'05	320i, 320d, 325i (E46) (EXC Compact, M3, cabrio, coupe & sport susp)	Rear
MK121	BMW	April'01 - Feb'05	330i & 330d (E46) (EXC 325ti compact (EXC M3, cabrio, coupe, sport susp & S/W)	Rear
MK121	BMW	98-05	E46 - Sport Pack II for BMW OE Sport Susp (EXC Ci)	Rear
MK121	BMW	Nov'01-05	318ti Compact (E46) (EXC Sport susp)	Rear
MK121	BMW	Nov'01-05	325ti Compact (E46) (EXC Sport susp)	Rear
MK121	BMW	00-05	318i Touring (E46) (EXC Sport susp)	Rear
MK121	BMW	00-05	320i, 325i Touring (E46) (EXC Sport susp)	Rear
MK121	BMW	00-06	 330Ci Cabriolet (EXC Sport Pac II & M3) (E46)	Rear
MK121	BMW	99-Sept'01	 325Ci, 330Ci Coupe (EXC Sport Pac II & M3) (E46)	Rear
MK121	BMW	Oct'01-06	 325Ci, 330 Ci Coupe (EXC Sport Pac II & M3) (E46)	Rear
MK121	BMW	00-06	 325Ci, 330 Ci Coupe Sport Pac II (EXC M3) (E46)	Rear
MK121	BMW	97-'03	Z3 1.8, 1.9, 2.8 & 3.0 (E36) (EXC M-tech & M Coupe)	Rear
MK121	BMW	04-09	Z4 2.0, 2.5 & 3.0 (EXC M-Tech 3.2M & Sport susp)	Rear
MK121	BMW	09-16	Z4 (E89) sDrive, 2.0i, 2.3i, 2.8i, 3.0i, 3.5i, 3.5iS, (EXC Sport susp & M-Tech)	Rear
MK122	BMW	88-95	5 Series (E34) (EXC Sport Susp, M Tech & M5) Note: See the INFO column for front shock selection details. Check OE #'s	Rear
MK122	BMW	Mid 90 -95	5 Series (E34) Std. & Sport Susp (EXC M Tech & M5) Note: See the INFO column for front shock selection details. Check OE numbers	Rear
MK123	BMW	96-'03	520i, 523i, 525i, 528i, 530d & 530i (E39) (EXC 535i, 540i, Sport susp, M5, Air Susp, M Tech, Elec susp & S/W)	Rear
MK123	BMW	96-'03	535i & 540i (E39) (EXC "protection", M5, Air Susp, M Tech, Sport susp, Elec susp & S/W)	Rear
MK124	BMW	86-88	730, 735 (E32) (EXC elec suspension & M Tech)	Rear
MK124	BMW	89-90	730, 735 (E32) (EXC elec suspension & M Tech)	Rear
MK124	BMW	91-94	730, 735 & 740 (E32) (EXC 750 & elec suspension & M Tech)	Rear
MK125	FIAT	90-'09	Uno (EXC raised body "Way" version from Brazil)	Rear
MK126	FORD	00-06	Ikon sedan All	Rear
MK126	MAZDA	97-99	121 Soho gen 4 (BE, JA, JB)	Rear
MK126	MAZDA	99-06	121 Soho gen 4 facelift (BE, JA, JB)	Rear
MK126	FORD	Mid 99-03	Fiesta (EXC RSi) Mk4 facelift (JA, JB)	Rear
MK126	FORD	97- Mid 99	Fiesta (EXC Power steering) Mk4 (JA, JB)	Rear
MK126	FORD	Mid 99-03	 Fiesta 3 door 1.6 RSi & ST sport with power steering Mk4 facelift (JA, JB)	Rear
MK126	FORD	05-09	Ka 1.3 Hatch	Rear
MK129	HONDA	03-08	Accord Sedan (EXC Type-R, ABS & S/W) 7th Gen (CM)	Rear
MK129	HONDA	03-09	Accord S/Wagon 7th Gen (EXC ABS & sport susp) (CM)	Rear
MK129	HONDA	03-08	Accord Sedan (EXC Type-R, ABS & S/W) 7th Gen (CM)	Front
MK129	HONDA	03-09	Accord S/Wagon 7th Gen (EXC ABS & sport susp) (CM)	Front
MK129	HONDA	March'01-05	 Civic Vtec 4 door Sedan (ES) Mk7	Rear
MK129	HONDA	March'01-05	 Civic Vtec 5 door hatch (EP, EU) Mk7 1.3, 1.4, 1.5, 1.6, 1.7i	Rear
MK129	HONDA	March'01-05	Civic Vtec 5 door hatch (EP, EU) Mk7 1.3, 1.4, 1.5, 1.6, 1.7i 2.0 (EXC Type R) & 1.7D	Rear
MK129	HONDA	99-02	Accord Sedan (EXC Type-R) 6th Gen (CK, CG, CH, CF)	Front
MK129	HONDA	09-12	Accord Sedan & S/W 8th Gen (CU)	Front
MK129	HONDA	09-12	Accord Sedan & S/W (EXC ABS) 8th Gen (CU)	Front
MK129	HONDA	89-91	Ballade 1500 & 1600 (EXC local CRX (EXC those with rear bottom U brackets -> Special order) Mk4 (SH4 / EF)	Front
MK129	HONDA	92-95	Ballade All (EXC local Encore & CRX (EXC those with rear bottom U brackets) Mk5 SR4 or EG	Front
MK129	HONDA	92-95	Ballade All (EXC imported Encore & CRX (With rear bottom U brackets) Mk5 EG or EH	Front
MK129	HONDA	96- March'01	Ballade & Civic (EXC Vtec (EJ9, EK1, EK3, EK4) Mk6	Front
MK129	HONDA	99-02	Accord Sedan (EXC Type-R) 6th Gen (CK, CG, CH, CF)	Rear
MK129	HONDA	09-12	Accord Sedan & S/W 8th Gen (CU)	Rear
MK129	HONDA	09-12	Accord Sedan & S/W (EXC ABS) 8th Gen (CU)	Rear
MK129	HONDA	89-91	Ballade 1500 & 1600 (EXC local CRX (EXC those with rear bottom U brackets -> Special order) Mk4 (SH4 / EF)	Rear

Key







*	See important installation information on inside front cover
!	Excluding self-levelling suspension
...	Special order - phone 010 900 1850. 6-12 week waiting period

~	Imported
#	Internal bump stop
⊕	Steering damper

- It is recommended that all new shock absorbers are fitted in pairs
- Do not mix gas and non-gas units on the same axle
- **Bold** part numbers indicate heavy-duty shocks
- Underlined part numbers indicate parts not immediately available
- *Italic* part numbers followed by > indicate parts to be discontinued

Mounting kits

Part number [numerical listing]

Part number	Make	Year	Application	Position
MK129	HONDA	92-95	Ballade All (MCI) local Encore & CRX (EXC) those with rear bottom U brackets) Mk5 SR4 or EG	Rear
MK129	HONDA	92-95	Ballade All (MCI) imported Encore & CRX (With rear bottom U brackets) Mk5 EG or EH	Rear
MK129 (EXC) bearings)	HONDA	98 - 02	CR-V 4x4 2.0 Gen 1 (RD1 - RD3)	Front
MK129 (EXC) bearings)	HONDA	98 - 02	CR-V 4x4 2.0 Gen 1 (RD1 - RD3)	Rear
MK129 (EXC) bearings)	HONDA	02-06	CR-V 4x4 2.0, 2.2 Gen 2 (RD4 - RD8) (Models with Xenon headlights - Check for rear shock bracket)	Rear
MK129 (EXC) bearings)	HONDA	07-12	CR-V 4x4 2.0, 2.2, 2.4 Gen 3 (RE) (heck for rear shock bracket OR NOT)	Rear
MK133 (EXC) bearings)	VOLKSWAGEN	85-93	Golf II & Jetta II	Rear
MK133 (EXC) bearings)	VOLKSWAGEN	92-94	Golf III & Jetta III (EXC) VR6)	Rear
MK133 (EXC) bearings)	VOLKSWAGEN	95-99	Golf III & Jetta III (MCI) Gti & Cti (EXC) VR6)	Rear
MK133 (EXC) bearings)	VOLKSWAGEN	93-99	Golf III & Jetta III VR6	Rear
MK133 (EXC) bearings)	VOLKSWAGEN	93-'04	Golf III & IV Cabriolet (EXC) 16" wheels)	Rear
MK133 (EXC) bearings)	VOLKSWAGEN	98-Sept'02	Polo Playa Hatch & Classic Sedan (mk 3 6N) (EXC) sport susp	Rear
MK134	VOLVO	94- 96	850 Sedan & S/Wagon (EXC) Lowered and Nivomat self leveling suspension)	Rear
MK134	VOLVO	97-'00	S70 Sedan (EXC) lowered & Nivomat leveling suspension)	Rear
MK134 (EXC) bearings)	VOLVO	97- Feb'00	V70 S/Wagon Gen1 (EXC) Elec Four-C & Nivomat rears)	Rear
MK136 (MCI) bearings)	BMW	96-'03	520i, 523i, 525i, 528i, 530d & 530i (E39) (EXC) 535i, 540i, Sport susp, M5, Air Susp, M Tech, Elec susp & S/W)	Front
MK136 (MCI) bearings)	BMW	96-'03	535i & 540i (E39) (EXC) "protection", M5, Air Susp, M Tech, Sport susp, Elec susp & S/W)	Front
MK136 (MCI) bearings)	BMW	97-'03	5 Series Touring S/W (EXC) 540i and Sport susp)	Front
MK136 (MCI) bearings)	BMW	End 04-Oct'11	1 Series 116i,118i, 120i, 130i & 120d (EXC) Sport Susp, xDrive & 135i Coupe)	Front
MK136 (MCI) bearings)	BMW	End 04-Oct'11	1 Series 116i,118i, 120i, 130i, 135i & 120d Sport Susp (MCI) std 135i Coupe (EXC) xDrive)	Front
MK136 (MCI) bearings)	BMW	99 - Sept'01	318i & 320d (E46) (EXC) M3, cabrio, coupe, & sport susp)	Front
MK136 (MCI) bearings)	BMW	99 - Sept'01	320i, 323i, 325i & 328i (E46) (EXC) M3, cabrio, coupe & sport susp)	Front
MK136 (MCI) bearings)	BMW	99- April'01	330i & 330d (E46) (EXC) M3, cabrio, coupe & sport)	Front
MK136 (MCI) bearings)	BMW	Sept'01- Feb'05	318i (E46) (EXC) Compact, M3, cabrio, coupe, sport susp & S/W)	Front
MK136 (MCI) bearings)	BMW	Sept'01- Feb'05	320i, 320d, 325i (E46) (EXC) Compact, M3, cabrio, coupe & sport susp)	Front
MK136 (MCI) bearings)	BMW	April'01- Feb'05	330i & 330d (E46) (MCI) 325ti compact (EXC) M3, cabrio, coupe ,sport susp & S/W)	Front
MK136 (MCI) bearings)	BMW	98-05	E46 - Sport Pack II for BMW OE Sport Susp (MCI) Ci	Front
MK136 (MCI) bearings)	BMW	Nov'01-05	318ti Compact (E46) (MCI) Sport susp	Front
MK136 (MCI) bearings)	BMW	Nov'01-05	325ti Compact (E46) (MCI) Sport susp	Front
MK136 (MCI) bearings)	BMW	00- 05	318i Touring (E46) (EXC) Sport susp)	Front
MK136 (MCI) bearings)	BMW	00-05	320i, 325i Touring (E46) (EXC) Sport susp)	Front
MK136 (MCI) bearings)	BMW	00-06	 330Ci Cabriolet (EXC) Sport Pac II & M3) (E46)	Front
MK136 (MCI) bearings)	BMW	99-Sept'01	 325Ci, 330Ci Coupe (EXC) Sport Pac II & M3) (E46)	Front
MK136 (MCI) bearings)	BMW	Oct'01-06	 325Ci, 330 Ci Coupe (EXC) Sport Pac II & M3) (E46)	Front
MK136 (MCI) bearings)	BMW	00-06	 325Ci, 330 Ci Coupe Sport Pac II (EXC) M3) (E46)	Front
MK136 (MCI) bearings)	BMW	March'05-12	3 series (E90 & E91) 320i, 320d, 323i, 325i, 330d, 330i & 335i (EXC) Sport susp, M3, Cabrio & Coupe)	Front
MK136 (MCI) bearings)	BMW	March'05-12	3 series Sport susp, (E90 & E91) 320i, 320d, 323i, 325i, 330d, 330i & 335i (EXC) M3, Cabrio & Coupe)	Front
MK136 (MCI) bearings)	BMW	07-12	 330i, 335i Cabriolet (EXC) M3, Coupe) (E93)	Front
MK136 (MCI) bearings)	BMW	07 - 12	 320i, 325i, 335i Coupe (EXC) M3, Cabrio) (E92)	Front
MK136 (MCI) bearings)	BMW	Nov'03-May'10	All E60 5 Series sedan (EXC) Touring S/W, M5 & Sport susp)	Front
MK136 (MCI) bearings)	BMW	Nov'03-May'10	All E60 5 Series sedan Sport susp (EXC) Touring S/W, & M5)	Front
MK136 (MCI) bearings)	BMW	04-May'10	All E61 5 Series Touring (EXC) Sedan, M5 & Sport susp)	Front
MK136 (MCI) bearings)	BMW	04-10	X3 (E83) 2.5, 3.0 & 2.0 d (MCI) Sport susp (EXC) elec susp)	Front
MK136 (MCI) bearings)	BMW	04-10	645i, 650i Coupe & Cabrio (EXC) M6)	Front
MK136 (MCI) bearings)	BMW	10-Oct 15	X1 (E84) sDrive FWD	Front
MK136 (MCI) bearings)	BMW	10-Oct 15	X1 (E84) xDrive AWD	Front
MK139	SUZUKI	89-99	Vitara (SWB) 2 doors 4X4 gen 1 (ET, TA)	Front
MK139	SUZUKI	91-99	Vitara (LWB) 4 doors 4X4 gen 1 (ET, TA)	Front
MK140 (MCI) bearings)	VOLVO	June'99-April'00	S40 Sedan & V40 S/W (MCI) T4 (EXC) Sport)	Front
MK140 (MCI) bearings)	VOLVO	95- May'99	S40 Sedan & V40 S/W (EXC) Sport & T4)	Front
MK140 (MCI) bearings)	VOLVO	95- May'99	S40 Sedan & V40 S/W T4 and Sportline	Front
MK140 (MCI) bearings)	VOLVO	April'00-May'04	S40 Sedan & V40 S/W (EXC) Sport & T4)	Front
MK140 (MCI) bearings)	VOLVO	April'00-Late'04	S40 Sedan & V40 S/W T4	Front
MK143R & MK144L	PEUGEOT	00-12	206 1.4, 1.6 XS, 1.6 XT, 2.0 HDi & 20 Gti Hatch (2A/C)	Front
MK143R & MK144L	PEUGEOT	02-12	206 S/Wagon 1.6, Cabrio cc	Front

Key

















*	See important installation information on inside front cover
!	Excluding self-leveling suspension
"..."	Special order - phone 010 900 1850. 6-12 week waiting period

~	Imported
#	Internal bump stop
⊕	Steering damper

- It is recommended that all new shock absorbers are fitted in pairs
- Do not mix gas and non-gas units on the same axle
- **Bold** part numbers indicate heavy-duty shocks
- Underlined part numbers indicate parts not immediately available
- *Italic* part numbers followed by > indicate parts to be discontinued

Mounting kits

Part number [numerical listing]

Part number	Make	Year	Application	Position
MK149	CHEVROLET	Aug'04-11	 Corsa Utility LDV	Front
MK149	OPEL	Nov'99-Sept'04	Astra hatch & Classic sedan (G) [EXC] OPC & S/W	Front
MK149	OPEL	05 - 09	Tigra 1.4, 1.8 TwinTop Cabriolet	Front
MK149	OPEL	01-05	Zafira 1.6, 1.8, 1.9CDTi, 2.2 MPV [EXC] 2.0 turbo & OPC) (A)	Front
MK149 [EXC] bearings)	OPEL	03-09	Meriva 1.4, 1.6, 1.7CDTi, 1.8 mini MPV (A)	Front
MK149 [EXC] bearings)	OPEL	01-Sept'04	Astra Caravan S/Wagon (G)	Front
MK149 [EXC] bearings)	OPEL	01-06	Astra Coupe & Cabriolet (G)	Front
MK149 [EXC] bearings)	OPEL	02-11	Combo Panel Van (C)	Front
MK149 [EXC] bearings)	OPEL	End 02-Oct'07	Corsa Hatch & Classic (sedan) [EXC] Lite) (C)	Front
MK149 [EXC] bearings)	OPEL	8/04-10	Corsa Utility LDV	Front
MK149 [EXC] bearings)	OPEL	10-17	Meriva 1.4 mini MPV 	Front
MK150 [INC] PK)	MERCEDES-BENZ	00-04	A160, A170CDi A190 (W168)	Front
MK156 [INC] bearings)	SEAT	06-08	Ibiza Hatch & Sedan [EXC] sport susp)	Front
MK156 [INC] bearings)	VOLKSWAGEN	Oct'02-Jan'10	Polo Hatch & Classic Sedan [EXC] CrossPolo (mk 4 9N3)	Front
MK159 [INC] bearings)	VOLVO	00-10	S60 Sedan gen 1 [EXC] elec susp, Four-C, R 2.5 20V, AWD, Lowered & Nivomat Levelling Suspensions)	Front
MK159 [INC] bearings)	VOLVO	98-July'06	S80 Sedan gen 1 [EXC] elec susp Four-C, Lowered & Nivomat Levelling Suspensions).	Front
MK159 [INC] bearings)	VOLVO	00-07	V70 S/Wagon Gen 2 [EXC] elec susp, Four-C, R 2.5 20V, XC AWD, Lowered & Nivomat Levelling Suspensions)	Front
MK159 [INC] bearings)	VOLVO	00-July'07	XC70 SUV AWD gen 2 [EXC] Four-C elec & self level suspension	Front
MK159 [INC] bearings)	VOLVO	02-July'15	XC90 AWD 2.4D, 3.2, 4.4 V8 Cross Country S/Wagon gen 1 [EXC] Elec or self lev susp)	Front
MK162	BMW	97- '03	5 Series Touring S/W [EXC] 540i and Sport susp)	Rear
MK171	TOYOTA	01- Feb'06	RAV4 (ACA20,21 / ZCA 25, 26 / XA20) gen 2	Front
MK171	TOYOTA	95-98	RAV4 Type SXA 10 & 11 [EXC] sealed struts & 235/60R 16" wheels) gen 1	Front
MK171	TOYOTA	98-00	RAV4 Type SXA 10 & 11 Sealed front struts [EXC] 235/60R 16" wheels) gen 1	Front
MK173	MAZDA	93-Mid 99	626 Sedan All [INC] MX6 (GE)	Rear
MK173	MAZDA	93-Mid 99	MX-6	Rear
MK179R & MK180L	TOYOTA	96-June'06	Tazz	Rear
MK179R & MK180L	TOYOTA	98-06	Conquest Carri Panel Van	Rear
MK179R & MK180L [EXC] bearings)	TOYOTA	89-96	  Corolla & Conquest [INC] Twin Cam & 1800 F.W.D P140 (EE90, AE92, CE90)	Rear
MK179R & MK180L [EXC] bearings)	TOYOTA	96-Oct'02	 Corolla Sedan P160 gen 7 [INC] Rsi & Rxi (E100, AE101)	Rear
MK179R & MK180L [EXC] bearings)	TOYOTA	96-June'06	 Conquest / Tazz (EE90, AE92)	Rear
MK181 [INC] bearings)	OPEL	07-14	Vivaro 1.9CDTi, 2.0 Van & Minibus (X83)	Front
MK181 [INC] bearings)	RENAULT	03 - 14	Trafic 1.9 Dci panel van gen 2 (X83)	Front
MK181 [INC] bearings)	RENAULT	End14-on	Trafic 2.0TD panel van gen 3 (X82, FG)	Front
MK181 [INC] bearings)	NISSAN	07-14	Primastar van 1.9 Dci gen 2 (X83)	Front
MK182	PEUGEOT	01-07	607 3.0 V6 [EXC] elec susp)	Front
MK183	FORD	10-Nov 15	Figo Hatch 1.4 gen 1	Front
MK183	FORD	07-15	Ikon sedan All	Front
MK183 [INC] bearings)	FORD	04-Oct'08	 Fiesta Sedan & Hatch Mk 5 JH, JD [INC] 2.0ST [EXC] 2.5 ST or RS)	Front
MK184 [INC] bearings)	CITROEN	04-11	C2 1.1i, 1.4i, 1.6i [EXC] Sport Susp) (JM)	Front
MK184 [INC] bearings)	CITROEN	02-May'06	C3 1.4i, 1.6i manual. [EXC] 1.6 auto, Hdi 80kw & 82kw 51mm OD strut base (FC / FN)	Front
MK184 [INC] bearings)	CITROEN	02-May'06	C3 1.6i 16v auto & Hdi 80kw & 82kw [EXC] 46mm OD strut base. (FC / FN)	Front
MK184 up to 2004 [INC] bearings)	CITROEN	02-09	 C3 Pluriel & Enterprise models - Convertible (HB)	Front
MK186	PEUGEOT	97-Feb'06	 406 Coupe 3.0 [EXC] elec susp)	Rear
MK188	AUDI	95- Jan'99	 A4 Sedan [EXC] Quattro, Sport) 8D, B5	Rear
MK188	AUDI	96- Jan'99	 A4 Avant [EXC] Quattro, Sport) 8D, B5	Rear
MK188	AUDI	Feb'99-Nov'00	 A4 Sedan [EXC] Sport susp, Avant S/W & Quattro) B5, 8D	Rear
MK188	AUDI	Feb'99-Nov'00	 A4 Avant [EXC] Sport susp, sedan & Quattro) B5, 8D	Rear
MK189	BMW	94-02	728i, 730d, 735i, 740i & 750i & Limo (E38) [EXC] Air Susp. & elec susp)	Rear
MK190	AUDI	95- Jan'99	 A4 Sedan [EXC] Quattro, Sport) 8D, B5	Front
MK190	AUDI	95- Jan'99	 A4 Quattro Sedan [EXC] Sport,) 8D, B5	Front
MK190	AUDI	96- Jan'99	 A4 Avant [EXC] Quattro, Sport) 8D, B5	Front
MK190	AUDI	Feb'99-Nov'00	 A4 Sedan [EXC] Sport susp, Avant S/W & Quattro) B5, 8D	Front

Key











*	See important installation information on inside front cover
!	Excluding self-levelling suspension
...	Special order - phone 010 900 1850. 6-12 week waiting period

~	Imported
#	Internal bump stop
⊕	Steering damper

- It is recommended that all new shock absorbers are fitted in pairs
- Do not mix gas and non-gas units on the same axle
- **Bold** part numbers indicate heavy-duty shocks
- Underlined part numbers indicate parts not immediately available
- *Italic* part numbers followed by > indicate parts to be discontinued

Mounting kits

Part number [numerical listing]

Part number	Make	Year	Application	Position
MK190	AUDI	Feb'99-Nov'00	 A4 Quattro & Sport Quattro (EXC) S4) B5, 8D	Front
MK190	AUDI	Feb'99-Nov'00	 A4 Avant (EXC) Sport susp, sedan & Quattro) B5, 8D	Front
MK190	AUDI	Feb'99-Nov'00	 A4 Avant Quattro (EXC) S4 & Sport suspension)	Front
MK190	AUDI	97-Jan'99	A6 Sedan & Avant (EXC) 2.7 Turbo, Quattro, Allroad & 4.2 V8) Only up to -> chassis No's 4B#X#070 000	Front
MK190	AUDI	97-April'00	A6 2.7 Turbo (EXC) Quattro, Allroad & 8 cyl) Up to -> chassis No's 4B#Y#200 000	Front
MK190	AUDI	97-Jan'99	A6 Quattro sedan & Avant S/W (EXC) 2.7 turbo, Allroad & 4.2 V8) Only up to -> chassis No's 4B#X#070 000	Front
MK190	AUDI	Feb'99-April'00	A6 Sedan & Avant S/W (EXC) Quattro, Allroad & 8cyl) (EXC) 2.7 Turbo From chassis No's 4B#X#070 000 -> 4B#Y#200 000	Front
MK190	AUDI	Feb'99-April'00	A6 Quattro sedan & Avant (EXC) 2.7 turbo, Allroad & 4.2 V8) From chassis No's 4B#X#070 000 -> 4B#Y#200 000	Front
MK190	AUDI	97-April'00	A6 2.7 Quattro Turbo, (EXC) Allroad 4WD & 4.2 V8) Up to -> chassis No's 4B#Y#200 000	Front
MK190	AUDI	May'00-March'04	A6 Sedan & Avant (EXC) Quattro, Allroad, 8cyl & Air Susp) From Ch#: 4B#1#000 001 -on	Front
MK190	AUDI	May'00-May'01	A6 Quattro sedan & Avant (EXC) Allroad & 4.2 V8)	Front
MK190	AUDI	June'01 - '04	A6 Quattro Sedan & Avant (EXC) All Road & 4.2 V8)	Front
MK190 (EXC bearings)	VOLKSWAGEN	99-05	 Passat Sedan (EXC) S/W, Sport Susp & 4WD 4-Motion Syncro) (B5)	Front
MK190 (EXC bearings)	VOLKSWAGEN	99-05	 Passat Sedan 2.3 V5 & 2.8 4WD 4-Motion Syncro (EXC) Sport Susp) (B5)	Front
MK193 (EXC bearings)	RENAULT	June'04-08	 Megane II cc Coupe 1.6, 1.9dCi, 2.0	Front
MK193 (EXC bearings)	RENAULT	June'04-08	 Megane II cc Cabriolet 1.6, 1.9dCi, 2.0	Front
MK193 (EXC bearings)	RENAULT	03-08	Megane II Sedan & Hatch All (EXC) Shake it (EXC) 2.0 T Sport)	Front
MK193 (EXC bearings)	RENAULT	March'04-end 09	Scenic II 1.6, 1.9dCi, 2.0	Front
MK193 (EXC bearings)	RENAULT	Sept'04-end 09	Grand Scenic II (LWB) 1.9dCi, 2.0	Front
MK194	VOLKSWAGEN	Oct'12-17	New Beetle (Type 2 / A5) 50mm front strut body	Front
MK194	VOLKSWAGEN	09-17	"Passat" CC (EXC) AWD 4-Motion Syncro (EXC) elec susp)	Front
MK194	AUDI	May'03-12	A3 all (EXC) Sportback (EXC) Quattro, Sport Susp & S3) OE Strut leg bottom outer diam = 50mm	Front
MK194	AUDI	May'03-12	A3 all (EXC) Sportback (EXC) Quattro, Sport Susp & S3) OE Strut leg bottom outer diam = 55mm	Front
MK194	AUDI	May'03-12	A3 & S3 Quattro and sport suspension 2.0 & 3.2 : 55mm OD strut only (EXC) S3 front & all RS3)	Front
MK194	AUDI	07-March'15	TT 1.8T, 2.0T, 3.2 V6 Coupe & Roadster/Cabriolet, (EXC) Quattro & Sport susp (8J) (EXC) elec susp & 2.5RS Quattro) (8J)	Front
MK194 (EXC bearing)	VOLKSWAGEN	04-Feb'09	Golf V (EXC) Gti, V5, R32 & Sport susp) 1K1. OE Strut leg bottom outer diam = 50mm	Front
MK194 (EXC bearing)	VOLKSWAGEN	04-Feb'09	Golf V (EXC) Gti, V5, R32 & Sport susp) 1K1. OE Strut leg bottom outer diam = 55mm	Front
MK194 (EXC bearing)	VOLKSWAGEN	04-Feb'09	Golf V Gti & R32 (EXC) 4-motion AWD	Front
MK194 (EXC bearing)	VOLKSWAGEN	March'09-13	Golf VI (EXC) Gti, V5, R32, AWD, Elec & Sport susp) OE Strut leg bottom outer diam = 50mm	Front
MK194 (EXC bearing)	VOLKSWAGEN	March'09-13	Golf VI (EXC) Gti, V5, R32, AWD, Elec & Sport susp) OE Strut leg bottom outer diam = 55mm	Front
MK194 (EXC bearing)	VOLKSWAGEN	March'09-13	Golf VI Gti & R32 (EXC) 4-motion AWD (EXC) elec susp	Front
MK194 (EXC bearings)	VOLKSWAGEN	04 - May 15	Caddy All gen 3 (2K) (check front strut OD for correct part) 50mm OD strut tube	Front
MK194 (EXC bearings)	VOLKSWAGEN	04 - May 15	Caddy All gen 3 (2K) (check front strut OD for correct part) 55mm OD Strut tube	Front
MK194 (EXC bearings)	VOLKSWAGEN	June 15-Oct '21	Caddy All gen 3, (2K Facelift)	Front
MK194 (EXC bearings)	VOLKSWAGEN	07-15	Eos Cabriolet	Front
MK194 (EXC bearings)	AUDI	11 - Sept '18	Q3 2.0TDi, 2.0T 4x2 & 4x4 Quattro (EXC) RS 2.5 sport or elec susp) 8U	Front
MK194 (EXC bearings)	SEAT	06-10	Altea Mini MPV OE Strut leg outer diam = 50mm	Front
MK194 (EXC bearings)	SEAT	06-10	Altea Mini MPV OE Strut leg outer diam = 55mm	Front
MK194 (EXC bearings)	SEAT	06-08	Leon Hatch (EXC) Cupra & Sport susp) OE Strut leg outer diam = 50mm	Front
MK194 (EXC bearings)	SEAT	06-08	Leon Hatch (EXC) Cupra & Sport susp) OE Strut leg outer diam = 55mm	Front
MK194 (EXC bearings)	VOLKSWAGEN	March'06-Sept'11	Jetta V (EXC) V5 & Sport susp) 1K2 (A5). Strut leg bottom outer diam = 50mm	Front
MK194 (EXC bearings)	VOLKSWAGEN	March'06-Sept'11	Jetta V (EXC) V5 & Sport susp) 1K2 (A5) OE Strut leg bottom outer diam = 55mm	Front
MK194 (EXC bearings)	VOLKSWAGEN	Oct'11-19	Jetta VI (EXC) V5 & Sport susp) 1B (A6). OE Strut leg bottom outer diam = 50mm	Front
MK194 (EXC bearings)	VOLKSWAGEN	Oct'11-19	Jetta VI (EXC) V5 & Sport susp) 1B (A6) OE Strut leg bottom outer diam = 55mm	Front
MK194 (EXC bearings)	VOLKSWAGEN	05 - 11	  Passat Sedan & S/Wagon (EXC) AWD 4 Motion Syncro (EXC) Sport Susp & Elec Susp) (B6)	Front
MK194 (EXC bearings)	VOLKSWAGEN	05 - 11	  Passat Sedan, & S/Wagon Sportline Sport Susp (EXC) AWD 4 Motion Syncro (EXC) elec susp) (B6)	Front
MK194 (EXC bearings)	VOLKSWAGEN	11-Aug'15	Passat sedan (EXC) Sport Susp & 4WD 4 Motion Syncro) (B7) (EXC) elec susp	Front
MK194 (EXC bearings)	VOLKSWAGEN	09-17	Scirocco (EXC) elec, R or sport susp) (137)	Front
MK194 (EXC bearings)	VOLKSWAGEN	08-Sept 16	Tiguan 4-Motion AWD & FWD (EXC) Blue Motion (EXC) elec susp) gen 1 (5N)	Front
MK194 (EXC bearings)	VOLKSWAGEN	04-16	Touran MPV (EXC) Elec & heavy duty Susp (1T gen 1)	Front
MK195 (EXC bearings)	VOLVO	00-07	V70 S/Wagon Gen 2 (EXC) elec susp, Four-C, R 2.5 20V, XC AWD, Lowered & Nivomat Levelling Suspensions)	Rear
MK195 (EXC bearings)	VOLVO	00-10	S60 Sedan gen 1 (EXC) elec susp, Four-C, R 2.5 20V, AWD, Lowered & Nivomat Levelling Suspensions)	Rear
MK195 (EXC bearings)	VOLVO	98-July'06	S80 Sedan gen 1 (EXC) elec susp Four-C, Lowered & Nivomat Leveling Suspensions).	Rear
MK195 (EXC bearings)	VOLVO	00-July'07	XC70 SUV AWD gen 2 (EXC) Four-C elec & self level suspension	Rear
MK197 (EXC bearings)	MINI	01-06	Mini One, Cooper, Cooper S, One D (R50, R52, R53 Mk 1)	Front

Key

















*	See important installation information on inside front cover
!	Excluding self-levelling suspension
...	Special order - phone 010 900 1850. 6-12 week waiting period

~	Imported
#	Internal bump stop
⊕	Steering damper

- It is recommended that all new shock absorbers are fitted in pairs
- Do not mix gas and non-gas units on the same axle
- **Bold** part numbers indicate heavy-duty shocks
- Underlined part numbers indicate parts not immediately available
- *Italic* part numbers followed by > indicate parts to be discontinued

Mounting kits

Part number [numerical listing]

Part number	Make	Year	Application	Position
MK198	MERCEDES-BENZ	April'02-09	 CLK320, CLK350 & CLK500 Coupe (C209) EXCI Sport & AMG	Front
MK198	MERCEDES-BENZ	02 - 09	 CLK320, CLK350 & CLK500 Cabriolet (A209) EXCI Sport & AMG	Front
MK198 INCI bearings)	MERCEDES-BENZ	Sept'00-April'07	C180, C180K, C200, C200K, C220CdI, C230, C230K, C240, C280, C320CdI, C350 & C270CDI (W203) INCI S/Wagon (C203) EXCI AMG, Coupe & Sports susp)	Front
MK198 INCI bearings)	MERCEDES-BENZ	Sept'00-April'07	W203 Sport Suspension EXCI AMG	Front
MK198 INCI bearings)	MERCEDES-BENZ	00-11	C180K, C200K, C230K and CLC200K, CLC350 (CLC203) EXCI Sport susp & AMG	Front
MK198 INCI bearings)	MERCEDES-BENZ	00-11	CLC203 Sport Suspension EXCI AMG	Front
MK200	ALFA ROMEO	05-10	2.0 & 1.9JTD & 3.2 V6 GTA	Rear
MK200	ALFA ROMEO	June'01-10	147 1.6TS, 1.9JTD & 2.0TS hatch	Rear
MK200	ALFA ROMEO	97-05	156 ALL EXCI GTA, Sport susp)	Rear
MK200	ALFA ROMEO	97-05	156 GTA & Sport Susp EXCI 3.2 GTA)	Rear
MK202 (bearing only) & MK394 (mounting)	FORD	Aug'11-15	Focus 1.0, 1.5, 1.6, 2.0Si, 2.0TDCi & TDCi Si, INCI 2.0ST front only, Hatch and Sedan MkIII C346 EXCI 2.0ST rear, RS, & facelift models)	Rear
MK202 (bearing only) & MK394 (mounting)	FORD	15-early'18	Focus (facelift) 1.0, 1.5, 1.6, 2.0Si, 2.0TDCi, TDCi Si, INCI 2.0ST front only, Hatch and Sedan MkIII C346 facelift EXCI 2.0 ST rear & RS)	Rear
MK202 (bearing only) + MK394 (mounting)	FORD	Nov'04-July'11	Focus 1.6, 1.6Si, 1.8TDCi, 2.0, 2.0Si, 2.0TDCi & TDCi Si, INCI 2.5 ST front only, Hatch and Sedan MkII DA, DP EXCI 2.5 ST rear & RS)	Rear
MK202 (bearing only) + MK394 (mounting)	FORD	Nov'04-July'11	Focus hatch MkII 2.5 ST & RS only	Rear
MK203	VOLKSWAGEN	09-17	"Passat" CC INCI AWD 4-Motion Syncro EXCI elec susp)	Rear
MK203 EXCI bearings)	VOLKSWAGEN	04-Feb'09	Golf V Gti & R32 INCI 4-motion AWD	Rear
MK203 EXCI bearings)	VOLKSWAGEN	March'09-13	Golf VI Gti & R32 INCI 4-motion AWD EXCI elec susp	Rear
MK203 EXCI bearings)	VOLKSWAGEN	05 - 11	  Passat Sedan & S/Wagon INCI AWD 4 Motion Syncro EXCI Sport Susp & Elec Susp) (B6)	Rear
MK203 EXCI bearings)	VOLKSWAGEN	05 - 11	  Passat Sedan, & S/Wagon Sportline Sport Susp INCI AWD 4 Motion Syncro EXCI elec susp) (B6)	Rear
MK203 EXCI bearings)	VOLKSWAGEN	11-Aug'15	Passat sedan EXCI Sport Susp & 4WD 4 Motion Syncro) (B7) EXCI elec susp	Rear
MK203 EXCI bearings)	VOLKSWAGEN	09-17	Scirocco EXCI elec, R or sport susp (137)	Rear
MK203 EXCI bearings)	VOLKSWAGEN	08-Sept 16	Tiguan 4-Motion AWD & FWD INCI Blue Motion EXCI elec susp) gen 1 (5N)	Rear
MK203 EXCI bearings)	AUDI	11 - Sept '18	Q3 2.0TDI, 2.0T 4x2 & 4x4 Quattro EXCI RS 2.5 sport or elec susp) 8U	Rear
MK203 EXCI bearings)	SEAT	06-08	Ibiza Hatch & Sedan EXCI sport susp)	Rear
MK203 EXCI bearings)	SEAT	06-08	Leon Hatch EXCI Cupra & Sport susp) OE Strut leg outer diam = 50mm	Rear
MK203 (round)	AUDI	May'03-12	A3 all INCI Sportback INCI Quattro, Sport Susp EXCI S3) OE Strut leg bottom outer diam 50mm + 55mm	Rear
MK203 (round) EXCI bearings)	VOLKSWAGEN	Oct'11-19	Jetta VI EXCI V5 & Sport susp) 1B (A6) OE Strut leg bottom outer diam = 50mm	Rear
MK203 (round) EXCI bearings)	VOLKSWAGEN	Oct'11-19	Jetta VI EXCI V5 & Sport susp) 1B (A6) OE Strut leg bottom outer diam = 55mm	Rear
MK203 (round) EXCI bearings)	VOLKSWAGEN	March'09-13	Golf VI EXCI Gti, V5, R32, AWD, Elec & Sport susp) OE Strut leg bottom outer diam = 50mm	Rear
MK203 (round) EXCI bearings)	VOLKSWAGEN	04-Feb'09	Golf V EXCI Gti, V5, R32 & Sport susp) 1K1. OE Strut leg bottom outer diam = 50mm	Rear
MK203 (round) EXCI bearings)	VOLKSWAGEN	March'06-Sept'11	Jetta V EXCI V5 & Sport susp) 1K2 (A5) Strut leg bottom outer diam = 50mm	Rear
MK203 (round) EXCI bearings)	VOLKSWAGEN	04-16	Touran MPV EXCI Elec & heavy duty Susp (1T gen 1)	Rear
MK206	BMW	04-10	X3 (E83) 2.5, 3.0 & 2.0 d INCI Sport susp EXCI elec susp)	Rear
MK207	AUDI	Dec'00- 04	 +  A4 Sedan & Avant + Quattro EXCI Sport Susp, S4, & RS4) B6, 8E	Front
MK207	AUDI	Dec'00- 04	 +  A4 Sedan and Avant Sport Suspension INCI Quattro sport EXCI S4 & RS4) B6, 8E	Front
MK207	AUDI	05-07	 (S/W) A4 INCI Quattro, Avant & Allroad EXCI Sport susp, S4 & RS4) B7	Front
MK207	AUDI	05-07	  A4 Sport susp INCI Quattro, Avant & Allroad EXCI S4 & RS4) B7	Front
MK207 EXCI bearings)	AUDI	11-19	A6 Sedan & Avant INCI Quattro EXCI Air & Elec susp) C7 Typ 4G	Front
MK207 EXCI bearings)	AUDI	11-early '18	A7 Sportback INCI Quattro EXCI Air or elec susp, and S7 or RS7 4.0 V8) 4G8	Front
MK210	HYUNDAI	03-11	Getz (TB)	Front
MK210	HYUNDAI	July'00-05	 Accent II (LC)	Front
MK210 INCI bearings)	HYUNDAI	June'97-June'00	 Accent I (X3) facelift (Larger rear springpan than earlier model)	Front
MK210 INCI bearings)	HYUNDAI	94-May'97	 Accent I (X3)	Front
MK211R & MK212L	HYUNDAI	04 - 10	Tucson All (JM) gen 1	Rear
MK211R & MK212L	KIA	Oct'04-Sept'10	Sportage 4x4 & 4x2 Gen 2 (JE / KM)	Rear
MK211R & MK212L	HYUNDAI	96- Aug'00	Elantra Sedan & S/W gen 2 (J2)	Rear
MK211R & MK212L	HYUNDAI	Aug'00-Oct'06	Elantra Sedan & S/W gen 3 (XD)	Rear
MK211R & MK212L	HYUNDAI	02-10	Matrix Mini MPV (FC)	Rear

Key

















































*	See important installation information on inside front cover
!	Excluding self-levelling suspension
"..."	Special order - phone 010 900 1850. 6-12 week waiting period

~	Imported
#	Internal bump stop
⊕	Steering damper

- It is recommended that all new shock absorbers are fitted in pairs
- Do not mix gas and non-gas units on the same axle
- **Bold** part numbers indicate heavy-duty shocks
- Underlined part numbers indicate parts not immediately available
- *Italic* part numbers followed by > indicate parts to be discontinued

Mounting kits

Part number [numerical listing]

Part number	Make	Year	Application	Position
MK211R & MK212L	HYUNDAI	97- 02	Tiburon coupe (RD)	Rear
MK213	HYUNDAI	04 - 10	Tucson All (JM) gen 1	Front
MK213	HYUNDAI	01-06	Santa Fe 4x2 & 4x4 Gen 1 (SM)	Front
MK213	KIA	Oct'04-Sept'10	Sportage 4x4 & 4x2 Gen 2 (JE / KM)	Front
MK215	HYUNDAI	00-01	Sonata (EF) gen 4	Front
MK215	HYUNDAI	01-'9/05	Sonata (EF-B) gen 4 facelift	Front
MK215	HYUNDAI	00-01	Sonata (EF) gen 4	Rear
MK215	HYUNDAI	01-'9/05	Sonata (EF-B) gen 4 facelift	Rear
MK217	KIA	95-Sept'99	Sportage 4x4 & 4x2 Gen 1 (NB7 / FM)	Front
MK220	HONDA	March'01-05	 Civic Vtec 4 door Sedan (ES) Mk7	Front
MK220	HONDA	March'01-05	 Civic Vtec 5 door hatch (EP, EU) Mk7 1.3, 1.4, 1.5, 1.6, 1.7i	Front
MK220	HONDA	March'01-05	Civic Vtec 5 door hatch (EP, EU) Mk7 1.3, 1.4, 1.5, 1.6, 1.7i 2.0  Type R & 1.7D	Front
MK222  bearings)	HYUNDAI	July'00-05	 Accent II (LC)	Rear
MK222  bearings)		June'97-June'00	 Accent I (X3) facelift (Larger rear springpan than earlier model)	Rear
MK222  bearings)	HYUNDAI	94-May'97	 Accent I (X3)	Rear
MK223  bearings)	TOYOTA	96-01	Export Camry (Japan mnf) SXV20, MCV20, XV20 gen 5	Rear
MK223  bearings)	TOYOTA	Sept'01-06	Camry (Australian mnf) ACV30, ACV31, ACV36, MCV30, MCV36, XV30 gen 6	Rear
MK224  bearings)	TOYOTA	Sept'01-06	Camry (Australian mnf) ACV30, ACV31, ACV36, MCV30, MCV36, XV30 gen 6	Front
MK227	HYUNDAI	97- 02	Tiburon coupe (RD)	Front
MK241  bearings)	TOYOTA	06-09	Avensis 2.0, 2.0D, 2.2D, 2.4 (T250)	Front
MK244  bearings)	VOLVO	95- May'99	S40 Sedan & V40 S/W  Sport & T4	Rear
MK244  bearings)	VOLVO	95- May'99	S40 Sedan & V40 S/W T4 and Sportline	Rear
MK244  bearings)	VOLVO	June'99-April'00	S40 Sedan & V40 S/W  Sport & T4	Rear
MK244  bearings)	VOLVO	June'99-April'00	S40 Sedan & V40 S/W T4	Rear
MK260	SUBARU	92-01	  Impreza 1 AWD 1.8 & 2.0  Air susp, GT Turbo Sport/ WRX Sti and Outback) (GC/GF/GM/GFC)	Rear
MK262	CHRYSLER	95-00	Voyager 2.0 SWB & Grand Voyager (GS) 3.3 V6 & 2.5 TD LWB  Rear Nivomat leveling susp & 4x4	Front
MK263R & MK264L	RENAULT	05 - 08	Modus 1.2, 1.4, 1.6 Hatch / mini MPV	Front
MK263R & MK264L  bearing)	NISSAN	04-10	Micra (K12E) gen3	Front
MK263R & MK264L  bearings &  '10-'13models)	RENAULT	End 06-March'13	Clio 1.4, 1.5dCi & 1.6  1.2, 2.0 Sport, R27, 2.0 RS) For 1.2 see Clio II above	Front
MK268	SAAB	01-10	9.5 sedan & S/W	Front
MK269R & "MK270L"	FIAT	08-16	Scudo 7 seater (gen 2)	Front
MK269R & "MK270L"	FIAT	02-06	Ulysse MPV	Front
MK269R & "MK270L"	PEUGEOT	03-08	807 MPV 2.2 Hdi	Front
MK269R & "MK270L"	PEUGEOT	09-14	Expert Panel Van 2.0 Hdi I  Tepee MPV gen 2	Front
MK272 (triangular)	TOYOTA	99-05	Yaris / Vitz Hatch  1.5 T-Sport (Cross border - non RSA) gen 1 (XP10)	Front
MK273	BMW	01-06	X5 (E53) 3.0i, 3.0d, 4.4iV8, 4.8 V8 4x4,  rear air susp  elec or self leveling susp &  front air susp)	Front
MK274	BMW	01-06	X5 (E53) 3.0i, 3.0d, 4.4iV8, 4.8 V8 4x4,  rear air susp  elec or self leveling susp &  front air susp)	Rear
MK275	CHEVROLET	03-11	Aveo gen one & two (T200 & T250 facelift)	Front
MK275	CHEVROLET	05-July'10	Spark (M200, M250)  Lite 2010-on	Front
MK275	CHEVROLET	Aug'10-17	Spark LITE (M200, M250)	Front
MK276	CHEVROLET	03-11	Aveo gen one & two (T200 & T250 facelift)	Rear
MK277  bearings)	MERCEDES-BENZ	96-05	Sprinter van / bus. B901, B902 = 200 series, B903 = 300 series & B904 = 400 series. Gen 1 NB: Check Strut body length	Front
MK277  bearings)	VOLKSWAGEN	03 - 06	LT 28, 32, 35 SWB Van Strut body length 319.5mm	Front
MK277  bearings)	VOLKSWAGEN	03 - 06	LT 28, 32, 35 SWB Van Strut body length 345.5mm	Front
MK277  bearings)	VOLKSWAGEN	03 - 06	LT 45, 46 LWB Van Strut body length 319.5mm	Front
MK277  bearings)	VOLKSWAGEN	03 - 06	LT 45, 46 LWB Van Strut body length 345.5mm	Front
MK278	CHRYSLER	01-07	Voyager 2.0 & 2.4 SWB; & Grand Voyager 2.8, 3.3 V6 & 2.5TD LWB  Rear Nivomat leveling susp & AWD 4x4	Front
MK279	BMW	Mid Feb-02'09	730d, 735i, 740i, 745i, 750i (E65)  Limo)	Rear
MK279  bearings)	BMW	04-10	645i, 650i Coupe & Cabrio  M6)	Rear
MK280  bearings)	MERCEDES-BENZ	5/07-May'14	C180, C200, C220Cdi, C230, C250, C250Cdi, C280, C300, C320Cdi, C350Cdi & C360  elec susp, Self level susp, AMG, Coupe, 4-Matic & Sports susp)	Front
MK280  bearings)	MERCEDES-BENZ	12-May'14	C Class Coupe  Sport susp & AMG (Check if std or elec susp)	Front
MK282	FORD	11-12	Kuga 4x2 & 4x4 SUV (gen 1) C394	Front

Key

















*	See important installation information on inside front cover
!	Excluding self-leveling suspension
"..."	Special order - phone 010 900 1850. 6-12 week waiting period

~	Imported
#	Internal bump stop
⊕	Steering damper

- It is recommended that all new shock absorbers are fitted in pairs
- Do not mix gas and non-gas units on the same axle
- **Bold** part numbers indicate heavy-duty shocks
- Underlined part numbers indicate parts not immediately available
- *Italic* part numbers followed by > indicate parts to be discontinued

Mounting kits

Part number [numerical listing]

Part number	Make	Year	Application	Position
MK282	MAZDA	05-10	Mazda 5 MPV Gen 2 (CR19)	Front
MK282	MAZDA	11-15	Mazda 5 MPV Gen 3 (CW)	Front
MK282(incbearings)	FORD	13-'19	Kuga 4x2 & 4x4 SUV (gen 2) DM2, C520	Front
MK282 (inc bearings)	FORD	Nov'04-July'11	Focus 1.6, 1.6Si, 1.8TDCi, 2.0, 2.0Si, 2.0TDCi & TDCi Si, inc 2.5 ST front only, Hatch and Sedan MkII DA, DP excl 2.5 ST rear & RS)	Front
MK282 (inc bearings)	FORD	Nov'04-July'11	Focus hatch MkII 2.5 ST & RS only	Front
MK282 (inc bearings)	FORD	Aug'11-15	Focus 1.0, 1.5, 1.6, 2.0Si, 2.0TDCi & TDCi Si, inc 2.0ST front only, Hatch and Sedan MkIII C346 excl 2.0ST rear, RS, & facelift models)	Front
MK282 (inc bearings)	FORD	15-early18	Focus (facelift) 1.0, 1.5, 1.6, 2.0Si, 2.0TDCi, TDCi Si, inc 2.0ST front only, Hatch and Sedan MkIII C346 facelift excl 2.0 ST rear & RS)	Front
MK282 (inc bearings)	MAZDA	Mid 09-Sept'14	Mazda 3 gen 2 (BL) excl MPS, sport susp or AWD	Front
MK282 (inc bearings)	MAZDA	04-09	Mazda 3 gen 1 (BK) excl MPS, sport susp or AWD	Front
MK282 (inc bearings)	VOLVO	07-13	C30 Hatch	Front
MK282 (inc bearings)	VOLVO	06-14	 C70 Cabriolet	Front
MK282 (inc bearings)	VOLVO	June'04-Oct'12	S40 Sedan & V50 S/W inc T5 (Gen 2)	Front
MK282 (inc bearings)	VOLVO	12-19	V40 Hatch inc T series	Front
MK282 (inc bearings)	VOLVO	12-19	V40 Cross Country inc T5	Front
MK287 (inc bearings)	VOLKSWAGEN	06-17	Crafter 3 ton and 3.5 ton, excl 4x4 & 5 ton (2E/2F)	Front
MK287 (excl bearings)	VOLKSWAGEN	06-17	Crafter 5 ton, excl 4x4, 3 ton & 3.5 ton (2E/2F)	Front
MK287 (excl bearings)	MERCEDES-BENZ	06-18	Sprinter 3 ton and 3.5 ton excl 4x4 gen 2 (B906)	Front
MK287 (excl bearings)	MERCEDES-BENZ	06-18	Sprinter 5 ton excl 4x4 (B906)	Front
MK287 (excl bearings)	MERCEDES-BENZ	19-on	Sprinter 3.5 ton 300 - 400 (VS30) excl AWD	Front
MK287 (excl bearings)	MERCEDES-BENZ	19-on	Sprinter 5 ton 500 (VS30) excl AWD	Front
MK288	MITSUBISHI	07-16	Lancer 1.5, 2.0 excl Evo (CY2A gen 9)	Rear
MK288	MITSUBISHI	03 -May'04	Outlander 2.0, 2.4 SUV (Gen 1) CU2W, CU5W	Rear
MK288	MITSUBISHI	June'04 -May'07	Outlander 2.0, 2.4 SUV (Gen 1) CU2W, CU5W	Rear
MK289	SUBARU	00-04	  Legacy III 2.0 & 2.5 4x4 (excl Air susp, 3.0 & Outback) (BE/BH)	Rear
MK289	SUBARU	05 - 09	  Legacy IV 2.0 & 3.0 4x4 (excl Air susp & Outback) (BL/BP)	Rear
MK289	SUBARU	05-09	Legacy Outback 2.5, 3.0 AWD (BP) gen 3 excl Self leveling or elec susp	Rear
MK294 (excl bearings)	TOYOTA	Nov'02-Sept'07	  Corolla Sedan & RunX Hatch (excl Verso MPV, TRD) gen 9 (E120 & E121)	Rear
MK294 (excl bearings)	TOYOTA	Nov'02-Sept'07	  "Bubble" Corolla Sedan & Hatch Cross border export mkt (excl Verso MPV, TRD) 1N2	Rear
MK296	TOYOTA	04-March'09	Prius Hybrid (NHW20, XW20) gen 2	Front
MK296 (inc bearings)	TOYOTA	Nov'02-Sept'07	  Corolla Sedan & RunX Hatch (excl Verso MPV, TRD) gen 9 (E120 & E121)	Front
MK297	AUDI	Dec'00- 04	 +  A4 Sedan & Avant + Quattro (excl Sport Susp, S4, & RS4) B6, 8E	Rear
MK297	AUDI	Dec'00- 04	 +  A4 Sedan and Avant Sport Suspension inc Quattro sport (excl S4 & RS4) B6, 8E	Rear
MK297	AUDI	05-07	(S/W) A4 inc Quattro, Avant & Allroad (excl Sport susp, S4 & RS4) B7	Rear
MK297	AUDI	05-07	 A4 Sport susp inc Quattro, Avant & Allroad (excl S4 & RS4) B7	Rear
MK297	AUDI	02-08	 A4 Cabriolet inc Sport susp	Rear
MK297	AUDI	July'04-11	A6 Sedan & Avant inc Quattro (excl Air susp) C6 Typ 4F	Rear
MK299	AUDI	July'04-11	A6 Sedan & Avant inc Quattro (excl Air susp) C6 Typ 4F	Front
MK300	NISSAN	08-24	NP200 3/4 ton LDV	Front
MK300	RENAULT	08-12	Logan sedan (U90)	Front
MK300 (inc bearings)	RENAULT	09-Feb'14	Sandero hatch (excl Stepway) (B90 / BS gen 1)	Front
MK300 (inc bearings)	RENAULT	09-Feb'14	Sandero Stepway (BS gen 1)	Front
MK300 (inc bearings)	RENAULT	13-Sept '18	Duster 4x2 1.6, 1.5dci (excl Auto) gen 1 (HS)	Front
MK300 (inc bearings)	RENAULT	13-Sept '18	Duster 4x4 1.6, 1.5dci (excl Auto) gen 1 (HS)	Front
MK300 (inc bearings)	RENAULT	Oct 18-on	Duster 4x2 1.5dCi & 1.6 gen 2 (HM)	Front
MK300 (inc bearings)	RENAULT	Oct 18-on	Duster 4x4 1.5dCi gen 2 (HM)	Front
MK300 (inc bearings)	RENAULT	13-Sept '18	Duster 4x4 1.6, 1.5dci (excl Auto) gen 1 (HS)	Rear
MK300 (inc bearings)	RENAULT	Oct 18-on	Duster 4x4 1.5dCi gen 2 (HM)	Rear
MK301	NISSAN	05-end 08	Murano 3.5 V6 4x4 SUV gen 1 (Z50)	Front
MK301 (inc bearings)	NISSAN	02-March'08	X-Trail All gen1 (T30)	Front
MK305	FIAT	March'12-16	Punto 1.2, 1.3 JTD, 1.4 Hatch (199) inc sport susp (excl turbo)	Front
MK305	FIAT	06-16	Grand Punto 1.2, 1.3, 1.4 & 1.9 (199)	Front
MK305	ALFA ROMEO	09-18	MiTo hatch 1.4, 1.4T, 1.6JTD (excl 1.4T QV sport, 1.8T GTA & Elec susp)	Front
MK305 (inc bearings)	FIAT	16-on	Tipo 1.4 & 1.6 (356)	Front

Key





*	See important installation information on inside front cover
!	Excluding self-levelling suspension
"..."	Special order - phone 010 900 1850, 6-12 week waiting period

~	Imported
#	Internal bump stop
⊕	Steering damper

- It is recommended that all new shock absorbers are fitted in pairs
- Do not mix gas and non-gas units on the same axle
- **Bold** part numbers indicate heavy-duty shocks
- Underlined part numbers indicate parts not immediately available
- *Italic* part numbers followed by > indicate parts to be discontinued

Mounting kits

Part number [numerical listing]

Part number	Make	Year	Application	Position
MK305 (MC bearings)	OPEL	Nov'15-19	Corsa Hatch 1.0T, 1.4 MC 1.4 Turbo Sport (E)	Front
MK305 (MC bearings)	OPEL	Nov'07-Oct'15	Corsa Hatch (EXC Lite, OPC and Sport) (D)	Front
MK308R & MK309L (MC bearings)	PEUGEOT	April '06-on	Boxer 2.2 Hdi, 3.0 Hdi Van LWB gen 3 (12Q, 14Q, 16Q, 20Q) 3.3 & 4.0 ton (EXC 4x4)	Front
MK310	LAND ROVER	98-'01	Freelander 1.8 & 2.0D (EXC) 2.5 V6 (L314)	Rear
MK310	LAND ROVER	01-March'07	Freelander All (MC) 2.5 V6 (L314)	Rear
MK312	LAND ROVER	98-'01	Freelander 1.8 & 2.0D (EXC) 2.5 V6 (L314)	Front
MK312	LAND ROVER	01-March'07	Freelander All (MC) 2.5 V6 (L314)	Front
MK313R & "MK314L"	FIAT	10-22	Doblo 1.6 Panorama MPV (152) & Cargo panel van (263)	Front
MK317 (EXC bearing)	FORD	Nov'08-Oct '12	Fiesta Sedan & Hatch Mk 6 CB1, CCN (MC) 1.6 ST	Front
MK317 (EXC bearing)	FORD	Dec 15-18	Figo Hatch & sedan 1.5 gen 2 (EXC) Freestyle Cross)	Front
MK317 (EXC bearings)	MAZDA	07-Feb'15	Mazda 2 (DE)	Front
MK321A	CITROEN	11-18	DS3 1.2 & 1.6 46mm OD strut base	Front
MK321A	CITROEN	11-18	DS3 1.2 & 1.6 51mm OD strut base	Front
MK321A (EXC bearing)	CITROEN	Dec'09-16	C3 II (EXC DS3 & Sport) (SC) 46mm & 51mm OD strut base	Front
MK321A (EXC bearing)	CITROEN	10-13	C3 Picasso	Front
MK321A (no bearings)	PEUGEOT	06-12	207 All	Front
MK322	CITROEN	Nov'10-16	C4 (Gen 2) 1.6i, 2.0, 2.0 HDi (EXC) DS4 & sport susp)	Front
MK322	CITROEN	11-16	DS4 1.6, 2.0	Front
MK322 (EXC bearings)	PEUGEOT	08-14	308 Hatch, S/W & Cabrio. gen 1 (T7)	Front
MK323	VOLVO	Aug'06-'14	S80 Sedan gen 2 (EXC) elec susp, T6, Four-C, Lowered, sport & Nivomat Leveling Suspensions)	Front
MK323	VOLVO	Aug'06-'14	S80 Sedan T6 AWD gen 2 All (EXC) elec susp, Lowered & Nivomat Leveling Suspensions)	Front
MK323 (MC bearings)	VOLVO	11-18	V60 S/Wagon (MC) Cross Country (EXC) elec susp	Front
MK323 (MC bearings)	VOLVO	07-10	V70 S/Wagon Gen 3 (EXC) D5, T6, Four-C AWD, V70 R, Elec susp, XC 4WD	Front
MK323 (MC bearings)	VOLVO	09-Sept 18	XC60 AWD Cross Country SUV gen 1 (EXC) elec & self leveling susp	Front
MK323 (MC bearings)	LAND ROVER	2015-Feb 2020	Discovery Sport SUV (MC) facelift (L550) (EXC) elec susp	Front
MK323 (MC bearings)	LAND ROVER	June 19-on	Range Rover Evoque gen 2, D200 diesel & P300e hybrid (EXC) elec susp & Sport (L551)	Front
MK323 (MC bearings)	VOLVO	10-18	S60 Sedan, gen 2 (EXC) elec susp	Front
MK323 (MC bearings)	VOLVO	Aug'07-15	XC70 SUV AWD 3.0 T6, 3.2, 2.4 D5 gen 3 (EXC) elec susp	Front
MK325->MK325A	MERCEDES-BENZ	Aug'02-09	W211 E200K, E220 Cdi, E240, E270CDi, E280, E320, E350, E500, E320CDi (EXC) S/Wagon, AMG & Elec & air susp)	Front
MK325->MK325A	MERCEDES-BENZ	Aug'02-mid 09	S211 S/Wagon E200K, E220 Cdi, E280, E320CDi, E350, E500 (EXC) AMG & Elec & air susp)	Front
MK325A	MERCEDES-BENZ	06-July'11	CLS350 & CLS500 (W219) (EXC) AMG	Front
MK326 (MC bearings)	RENAULT	08-Nov '20	Kangoo 2 MPV & minivan (Check OE front strut outer diameter & bottom bracket width for correct selection)	Front
MK326 (MC bearings)	RENAULT	08-Nov '20	Kangoo 2 MPV & minivan (Check OE front strut outer diameter & bottom bracket width for correct selection)	Front
MK327 (MC bearings)	RENAULT	end 09-16	Scenic III MPV 1.6, 1.9dCi	Front
MK327 (MC bearings)	RENAULT	09-Aug 16	Megane III Hatch 1.2T, 1.4T, 1.6, 1.9dCi (EXC) 2.0T GT, RS & Sport susp)	Front
MK327 (MC bearings)	RENAULT	09-Aug 16	Megane III cc Coupe (EXC) Cabriolet & 2.0T GT, & RS)	Front
MK327 (MC bearings)	RENAULT	end 09-16	Grand Scenic III (LWB) 1.9dCi	Front
MK329R & "MK330L" (EXC bearings)	PEUGEOT	11-18	508 sedan gen 1 (W23, 8D)	Front
MK331 (MC bearings)	TOYOTA	Oct '07-13	 Corolla Sedan 1.4, 1.6, 1.8, 2.0D gen 10 (E140, E150, E152)	Front
MK331 (MC bearings)	TOYOTA	Feb 14-19	 Corolla Sedan 1.3, 1.4D, 1.6, 1.8 gen 11 "Professional" (EXC) Quest (E170 / E180)	Front
MK331 (MC bearings)	TOYOTA	14-19	 Corolla QUEST 1.6 gen 10 (E140, E150)	Front
MK331 (MC bearings)	TOYOTA	Feb 19-on	 Corolla QUEST 1.8, gen 11 (E170, / E180)	Front
MK331 (MC bearings)	TOYOTA	07-March'13	Auris 1.4, 1.6, 1.8, 2.0 hatch (E150 / 330N) (EXC) TRD	Front
MK331 (MC bearings)	TOYOTA	April'13-19	Auris (E180)	Front
MK332	HYUNDAI	Nov'06-July'11	Elantra Sedan gen 4 (HD)	Front
MK332 (MC bearing)	HYUNDAI	09-June'12	i30 Hatch (FD) gen 1	Front
MK332 (MC bearing)	KIA	09-12	Cee'd hatch 2.0 3-door (ED)	Front
MK333	MITSUBISHI	June'04 -May'07	Outlander 2.0, 2.4 SUV (Gen 1) CU2W, CU5W	Front
MK333	PEUGEOT	12-16	4008 SUV	Front
MK333 (MC bearings)	MITSUBISHI	11-23	ASX SUV gen 1 (GA, W)	Front
MK333 (MC bearings)	MITSUBISHI	07-16	Lancer 1.5, 2.0 (EXC) Evo (CY2A gen 9)	Front
MK333 (MC bearings)	MITSUBISHI	03 -May'04	Outlander 2.0, 2.4 SUV (Gen 1) CU2W, CU5W	Front
MK333 (MC bearings)	MITSUBISHI	June '07-'12	Outlander 2.4 SUV (Gen 2, GS platform) CW5W (MC) '10-'12 Facelift models	Front

Key











*	See important installation information on inside front cover
!	Excluding self-leveling suspension
"..."	Special order - phone 010 900 1850. 6-12 week waiting period

~	Imported
#	Internal bump stop
⊕	Steering damper

- It is recommended that all new shock absorbers are fitted in pairs
- Do not mix gas and non-gas units on the same axle
- **Bold** part numbers indicate heavy-duty shocks
- Underlined part numbers indicate parts not immediately available
- *Italic* part numbers followed by > indicate parts to be discontinued

Mounting kits

Part number [numerical listing]

Part number	Make	Year	Application	Position
MK333 (INCL bearings)	PEUGEOT	09-10	4007 SUV (VU, VV)	Front
MK333 (INCL bearings)	CITROEN	13-17	C4 Aircross SUV 2.0, 1.6Hdi 4x2 & 4x4	Front
MK334R & MK335L	NISSAN	07-09	Qashqai SUV All (J10)	Front
MK334R & MK335L	NISSAN	10-June'14	Qashqai SUV INCL all +2, 1.5dci, 1.6, 2.0 (J10 facelift)	Front
MK334R & MK335L	NISSAN	10-June'14	Qashqai SUV 2.0 dci (J10 facelift, EXCL +2)	Front
MK334R & MK335L (INCL bearings)	NISSAN	April '08-Aug'14	X-Trail All gen 2 (T31)	Front
MK334R & MK335L (INCL bearings)	RENAULT	08-13	Koleos 4x4 SUV gen 1 (HY)	Front
MK336	HONDA	03-04	Jazz 1.4 Dsi & 1.5 Vtec gen 1 (GD)	Front
MK336	HONDA	05-07	Jazz 1.4 Dsi & 1.5 Vtec gen 1 (GD facelift)	Front
MK336	HONDA	08-Jan'15	Jazz 1.4 Dsi & 1.5 Vtec gen 2 (GE)	Front
MK336	HONDA	11-14	Ballade gen 5 (GM2, GM3)	Front
MK337 (INCL bearings)	HYUNDAI	06-July'11	  Accent III (MC)	Front
MK337 (INCL bearings)	KIA	March'06-Oct'11	Rio 1.4, 1.6 gen 2 (JB)	Front
MK339	MAZDA	Mid 99-03	626 sedan (GF) [assembled in Zimbabwe]	Front
MK339	MAZDA	Mid 99-03	[S/W] 626 S/W (GW) [assembled in Zimbabwe]	Front
MK341	AUDI	06 - June'15	Q7 4x4 Quattro (EXCL sport or air susp) Gen one 4L INCL facelift	Front
MK341	AUDI	06 - June'15	Q7 4x4 Quattro (EXCL sport or air susp) Gen one 4L INCL facelift	Rear
MK341 (EXCL bearings)	VOLKSWAGEN	04-10	Touareg 4x4 (EXCL Elec, air or sport susp (7L)	Front
MK341 (EXCL bearings)	PORSCHE	03-10	Cayenne 4x4 SUV (9PA)	Rear
MK341 (EXCL bearings)	PORSCHE	11-17	Cayenne 4x4 SUV (92A)	Rear
MK343 (bearings only)	OPEL	03-09	Meriva 1.4, 1.6, 1.7CDTi, 1.8 mini MPV (A)	Front
MK343 (bearings only)	OPEL	10-17	Meriva 1.4 mini MPV 	Front
MK343 (INCL bearings)	OPEL	End 02-Oct'07	Corsa Hatch & Classic (sedan) (EXCL Lite) (C)	Front
MK345	VOLKSWAGEN	Oct'12-17	New Beetle (Type 2 / A5) 55mm front strut body	Front
MK345	HONDA	96- March'01	Ballade & Civic INCL Vtec (EJ9, EK1, EK3, EK4) Mk6	Rear
MK347 (bearing only)	NISSAN	04-10	Micra (K12E) gen3	Front
MK347 (bearing only)	NISSAN	Aug'06-13	Tiida 1.6 & 1.8 Hatch / Sedan gen 1 (X11C)	Front
MK347 (bearings only)	RENAULT	End 06-March'13	Clio 1.4, 1.5dCi & 1.6 (EXCL 1.2, 2.0 Sport, R27, 2.0 RS) For 1.2 see Clio II above	Front
MK347 (bearings only)	NISSAN	14-on	NV200 panel van & 7 seater Combi MPV 1.6 & 1.5dci	Front
MK351	PEUGEOT	07-15	107 Hatch 1.0	Front
MK351	CITROEN	08-14	C1 1.0 & 1.4 Hdi Gen 1 (PM)	Front
MK351 (INCL bearings)	TOYOTA	11-Sept'15	Aygo hatch gen 1 (AB10)	Front
MK351 (INCL bearings)	TOYOTA	Oct'15-21	Aygo hatch gen 2 (AB40) (EXCL Agya models	Front
MK354	HONDA	06-Aug '16	 Civic 1.8, 2.2 Hatch Mk8 + Mk9 (FN, FK) (EXCL Type R & Tourer S/W	Front
MK354	HONDA	06-April'11	 Civic 1.8 Sedan Mk8 (FD, FA)	Front
MK356 (EXCL bearings)	SUZUKI	98-04	Grand Vitara 4x4 (EXCL XL gen 2 (FT, GT)	Front
MK356 (EXCL bearings)	SUZUKI	03-04	Grand Vitara XL 4x4 gen 2 (EXCL std SWB	Front
MK359 (INCL bearings)	MINI	07-13	Mini One, Cooper, Cooper D, Cooper S, One D (R56,R57 Mk II) INCL cabriolet (R57) & sport	Front
MK359 (INCL bearings)	MINI	08-14	Mini Clubman S/Wagon INCL sport (R55) mkl	Front
MK359 (INCL bearings)	MINI	11-16	Mini Countryman SUV Crossover INCL AWD (R60) mkl	Front
MK359 (INCL bearings)	MINI	13-16	Mini Paceman 2 door crossover (R61)	Front
MK359 (INCL bearings)	MINI	11-15	Mini Coupe (R58) & Roadster Cabriolet (R59)	Front
MK360 (INCL bearings)	HONDA	07-12	CR-V 4x4 2.0, 2.2, 2.4 Gen 3 (RE) (Models with Xenon headlights - Check for rear shock bracket)	Front
MK360 (INCL bearings)	HONDA	End 12-14	CR-V 4x4 2.0, 2.2, 2.4 Gen 4 (RM)	Front
MK360 (INCL bearings)	HONDA	End 15-July17	CR-V 4x4 2.0, 2.2, 2.4 Gen 4 (RM) facelift	Front
MK361	AUDI	08-Jan 16	  A4 Sedan & Avant (EXCL Sport susp, Quattro, Elec susp & S4) B8	Front
MK361	AUDI	08-Jan 16	  A4 Sedan & Avant Sport Susp, INCL Quattro (EXCL S4 & Elec susp) B8	Front
MK361	AUDI	08-Jan '16	A5 Sportback Coupe, Cabrio & Quattro (EXCL Sport Susp, S5 & RS5) (8T, B8)	Front
MK361	AUDI	08-Jan 16	S5 Sportback Coupe & Cabrio INCL A5 Sport Susp, Quattro (EXCL RS5 4.2 V8 (8T)	Front
MK361 (EXCL bearings)	AUDI	08 - 17	Q5 4x4 Quattro (EXCL sport susp) Typ 8R	Front
MK364	FORD	07-15	Ikon sedan All	Rear
MK364	FORD	15-17	B-Max Mini MPV 1.0 (JK)	Rear
MK364	MAZDA	07-Feb'15	Mazda 2 (DE)	Rear
MK364	FORD	04-Oct'08	 Fiesta Sedan & Hatch Mk 5 JH, JD INCL 2.0ST (EXCL 2.5 ST or RS)	Rear

Key



*	See important installation information on inside front cover
!	Excluding self-levelling suspension
"..."	Special order - phone 010 900 1850, 6-12 week waiting period

~	Imported
#	Internal bump stop
⊕	Steering damper

- It is recommended that all new shock absorbers are fitted in pairs
- Do not mix gas and non-gas units on the same axle
- **Bold** part numbers indicate heavy-duty shocks
- Underlined part numbers indicate parts not immediately available
- *Italic* part numbers followed by > indicate parts to be discontinued

Mounting kits

Part number [numerical listing]

Part number	Make	Year	Application	Position
MK364	FORD	Nov'08-Oct '12	 Fiesta Sedan & Hatch Mk 6 CB1, CCN (<u>MK3</u> 1.6 ST)	Rear
MK364	FORD	Nov 12-17	 Fiesta Sedan & Hatch Mk 6 facelift (<u>EXC</u> ST)	Rear
MK364	FORD	17-22	 Fiesta Sedan & Hatch Mk 7 HJ, HF	Rear
MK364	FORD	10-Nov 15	Figo Hatch 1.4 gen 1	Rear
MK364	FORD	Dec 15-18	Figo Hatch & sedan 1.5 gen 2 (<u>EXC</u> Freestyle Cross)	Rear
MK364	FORD	18-21	Figo Hatch & sedan gen 3	Rear
MK364 (<u>EXC</u> bearings)	FORD	13-on	EcoSport cross-over SUV 1.0T, 1.5, 1.5TDCi (Gen 2)	Rear
MK366	SMART	End 04-07	ForFour 1.3 Pulse & 1.5 Passion (W454 gen 1)	Front
MK372 (<u>MK3</u> bearings)	VOLKSWAGEN	Aug'04 - 15	Type V Caravelle, Kombi, Crew bus, Transporter LCV & Van T5 <u>MK3</u> 4Motion 4WD (front engine) <u>EXC</u> front struts with bottom camber brackets	Front
MK372 (<u>MK3</u> bearings)	VOLKSWAGEN	16 - On	Type VI T6 Caravelle, California, Kombi, Transporter van, Crew bus & Van <u>MK3</u> 4Motion 4WD <u>EXC</u> elec susp	Front
MK374R & MK375L	FIAT	03-early 10	Doblo 1.3, 1.4 & 1.9 Cargo panel Van (119) (223)	Front
MK374R & MK375L	FIAT	00-03	Palio hatch Type 1X MkI	Front
MK374R & MK375L	FIAT	00-02	Palio Weekend S/Wagon Type PY & 1Y	Front
MK374R & MK375L	FIAT	02-10	Palio II Weekend S/Wagon Type 2G & 2K 1.4 (<u>EXC</u> 2K 1.6)	Front
MK374R & MK375L	FIAT	00-02	Siena sedan Type 2A	Front
MK374R & MK375L	FIAT	05-16	Strada 3/4 ton LDV Pickup: 1.2, 1.4, 1.6, 1.7TD	Front
MK374R & MK375L	FIAT	03-10	Palio II hatch Type 2H MkIV	Front
MK374R & MK375L	FIAT	01-10	Palio Expresso panel Van	Front
MK374R & MK375L	FIAT	02-10	Siena II sedan	Front
MK377->MK377A	MERCEDES-BENZ	5/07-May 14	C180, C200, C220Cdi, C230, C250, C250Cdi, C280, C300, C320Cdi, C350Cdi & C350 (<u>EXC</u> elec susp, Self level susp, AMG, Coupe, 4-Matic & Sports susp)	Rear
MK377->MK377A	MERCEDES-BENZ	Mid 09-April '16	W212 E200, E250, E250CDi, E300, E350, E400, E500 (<u>EXC</u> S/W, Coupe, Cabrio, AMG, sport susp, air susp, elec susp & AWD)	Rear
MK377->MK377A	MERCEDES-BENZ	Mid 09-April '16	W212 S/Wagon E200, E250, E300, E350, E500 (<u>EXC</u> Sedan,, Coupe, Cabrio, AMG, sport susp, air susp, elec susp & AWD)	Rear
MK378	MERCEDES-BENZ	05-12	A170, A180CDi, A200 (W169)	Front
MK378	MERCEDES-BENZ	06-March'12	B170, B200T, B200CDi (W245)	Front
MK379(*CompareMKto-photospriorordering)	BMW	March'05-12	3 series (E90 & E91) <u>MK3</u> Sport susp(<u>EXC</u> M3, Cabrio & Coupe)	Rear
MK379 (*Compare orig MK to photos prior to ordering. All <u>EXC</u> bearings)	BMW	End 04-Oct'11	1 Series Inclm Sport Susp, (<u>EXC</u> xDrive & 135i Coupe)	Rear
MK379 (*Compare orig MK to photos prior to ordering. All <u>EXC</u> bearings)	BMW	07-12	330i, 335i Cabriolet (<u>EXC</u> M3, Coupe) (E93) + 320i, 325i, 335i Coupe (<u>EXC</u> M3, Cabrio) (E92)	Rear
MK379 <u>EXC</u> bearings (Compare MK to photos prior to ordering)	BMW	10-Oct 15	X1 (E84) sDrive FWD & X1 (E84) xDrive AWD	Rear
MK380 (*Compare MK to photos prior to ordering)	BMW	March'05-12	3 series (E90 & E91) <u>MK3</u> Sport susp(<u>EXC</u> M3, Cabrio & Coupe)	Rear
MK380 (*Compare orig MK to photos prior to ordering. All <u>EXC</u> bearings)	BMW	End 04-Oct'11	1 Series Inclm Sport Susp, (<u>EXC</u> xDrive & 135i Coupe)	Rear
MK380 (*Compare orig MK to photos prior to ordering. All <u>EXC</u> bearings)	BMW	07-12	330i, 335i Cabriolet (<u>EXC</u> M3, Coupe) (E93) + 320i, 325i, 335i Coupe (<u>EXC</u> M3, Cabrio) (E92)	Rear
MK380 <u>EXC</u> bearings (Compare MK to photos prior to ordering)	BMW	10-Oct 15	X1 (E84) sDrive FWD & X1 (E84) xDrive AWD	Rear
MK381	CHEVROLET	09-18	Cruze J300 (gen one) & J400 (gen two) Sedan & Hatch <u>MK3</u> Sport susp, (<u>EXC</u> OPC)	Front
MK381	CHEVROLET	11-18	Orlando MPV (J309)	Front
MK381 (bearings only)	OPEL	15-April 22	Mokka & Mokka X cross-over SUV FWD (<u>EXC</u> AWD) [Facelift Aug '16] gen 1 (J13)	Front
MK381 (<u>EXC</u> bearings)	OPEL	18-on	Combo Cargo Panel Van & Life minibus 1,6TD (E)	Front
MK381 (<u>MK3</u> bearings)	OPEL	end 10-May 16	Astra (<u>EXC</u> OPC, GTC, Elec susp) (J)	Front
MK381 (<u>MK3</u> bearings)	OPEL	11-18	Astra GTC coupe <u>MK3</u> OPC (J)	Front

Key







*	See important installation information on inside front cover
!	Excluding self-levelling suspension
"..."	Special order - phone 010 900 1850. 6-12 week waiting period

~	Imported
#	Internal bump stop
⊕	Steering damper

- It is recommended that all new shock absorbers are fitted in pairs
- Do not mix gas and non-gas units on the same axle
- **Bold** part numbers indicate heavy-duty shocks
- Underlined part numbers indicate parts not immediately available
- *Italic* part numbers followed by > indicate parts to be discontinued

Mounting kits

Part number [numerical listing]

Part number	Make	Year	Application	Position
MK382 (EXC bearings)	PEUGEOT	Oct'12-20	208 1All gen 1 (A9)	Front
MK382 (EXC bearings)	CITROEN	13-17	C4 Cactus crossover SUV	Front
MK382 (EXC bearings)	PEUGEOT	13-19	2008 Crossover SUV 1.2T, 1.6 gen 1 (CU / A94)	Front
MK384R & MK385L	ALFA ROMEO	09-18	MiTo hatch 1.4, 1.4T, 1.6 JTD (EXC 1.4T QV sport, 1.8T GTA & Elec susp)	Rear
MK384R & MK385L	FIAT	06-16	Grand Punto 1.2, 1.3, 1.4 & 1.9 (199)	Rear
MK384R & MK385L	CHEVROLET	11-18	Sonic sedan & hatch 1.4 & 1.6 (T300) (EXC RS 1.4 Turbo)	Rear
MK384R & MK385L	FIAT	March'12-16	Punto 1.2, 1.3 JTD, 1.4 Hatch (199) (EXC sport susp (EXC turbo)	Rear
MK384R & MK385L (EXC bearings)	OPEL	Nov'07-Oct'15	Corsa Hatch (EXC Lite, OPC and Sport) (D)	Rear
MK384R & MK385L (EXC bearings)	OPEL	Nov'15-19	Corsa Hatch 1.0T, 1.4 (EXC 1.4 Turbo Sport (E)	Rear
MK384R & MK385L (EXC bearings)	OPEL	14-19	Adam 1.0T, 1.4 (EXC "S" (M13)	Rear
MK386 (oval)	AUDI	May'03-12	A3 all (EXC Sportback (EXC Quattro, Sport Susp (EXC S3) OE Strut leg bottom outer diam 50mm + 55mm	Rear
MK386 (oval) (EXC bearings)	VOLKSWAGEN	Oct'11-19	Jetta VI (EXC V5 & Sport susp) 1B (A6) OE Strut leg bottom outer diam = 55mm	Rear
MK386 (oval) (EXC bearings)	VOLKSWAGEN	Oct'11-19	Jetta VI (EXC V5 & Sport susp) 1B (A6) OE Strut leg bottom outer diam = 50mm	Rear
MK386 (oval) (EXC bearings)	VOLKSWAGEN	04-Feb'09	Golf V (EXC Gti, V5, R32 & Sport susp) 1K1. OE Strut leg bottom outer diam = 50mm	Rear
MK386 (oval) (EXC bearings)	VOLKSWAGEN	March'09-13	Golf VI (EXC Gti, V5, R32, AWD, Elec & Sport susp) OE Strut leg bottom outer diam = 50mm	Rear
MK386 (oval) (EXC bearings)	VOLKSWAGEN	04-16	Touran MPV (EXC Elec & heavy duty Susp (1T gen 1)	Rear
MK386 (oval) (EXC bearings)	VOLKSWAGEN	March'06-Sept'11	Jetta V (EXC V5 & Sport susp) 1K2 (A5) Strut leg bottom outer diam = 50mm	Rear
MK387 (round)	TOYOTA	Oct'11- 19	Yaris Hatch 1.0, 1.3 & Sedan gen 3 (XP130)	Front
MK387 (round)	TOYOTA	05 - Sept'11	Yaris Hatch & (Vios) Sedan (NBC2) gen 2 (XP90)	Front
MK388	AUDI	08-Jan 16	  A4 Sedan & Avant (EXC Sport susp, Quattro, Elec susp & S4) B8	Rear
MK388	AUDI	08-Jan 16	  A4 Sedan & Avant Sport Susp, (EXC Quattro (EXC S4 & Elec susp) B8	Rear
MK388	AUDI	08-Jan '16	A5 Sportback Coupe, Cabrio & Quattro (EXC Sport Susp, S5 & RS5) (8T, B8)	Rear
MK388	AUDI	08-Jan 16	S5 Sportback Coupe & Cabrio (EXC A5 Sport Susp, Quattro (EXC RS5 4.2 V8 (8T)	Rear
MK388 (EXC bearings)	AUDI	08 - 17	Q5 4x4 Quattro (EXC sport susp) Typ 8R	Rear
MK388 (EXC bearings)	PORSCHE	14-on	Macan 4x4 SUV (95B)	Rear
MK389 (bearing only)	VOLVO	June'99-April'00	S40 Sedan & V40 S/W (EXC T4 (EXC Sport)	Front
MK390	BMW	11-18	640i, 645i, 650i Coupe (F13), Cabrio (F12) & Gran Coupe (F06) (EXC M6)	Front
MK391	BMW	June'10-16	All F07 Gran Turismo GT 5 Series Liftback (EXC Sedan, F11 Touring S/W, xDrive & M5)	Rear
MK392	BMW	07-13	X5 (E70) 3.5i xDrive, 5.0i V8 xDrive, 3.0d xDrive, 4.0d xDrive 4x4, (EXC sport susp (EXC Mtech M5.0d, Elec or Self Leveling susp)	Front
MK392	BMW	07-13	X5 (E70) 3.5i xDrive, 5.0i V8 xDrive, 3.0d xDrive, 4.0d xDrive 4x4, (EXC Self Leveling & sport susp (EXC Mtech M5.0d or Elec susp)	Front
MK392	BMW	09-Jan'15	X6 (E71) Cross-over SUV (EXC Mtech M5.0d, X6M, Elec or Self Leveling susp)	Front
MK392	BMW	09-Jan'15	X6 (E71) Cross-over SUV (EXC Self Leveling (EXC Mtech M5.0d, X6M or Elec susp)	Front
MK393 (EXC bearings)	VOLVO	10-18	S60 Sedan, gen 2 (EXC elec susp	Rear
MK393 (EXC bearings)	VOLVO	07-10	V70 S/Wagon Gen 3 (EXC D5, T6, Four-C AWD, V70 R, Elec susp, XC 4WD	Rear
MK393 (EXC bearings)	VOLVO	09-Sept 18	XC60 AWD Cross Country SUV gen 1 (EXC elec & self leveling susp	Rear
MK393 (EXC bearings)	VOLVO	Aug'07-15	XC70 SUV AWD 3.0 T6, 3.2, 2.4 D5 gen 3 (EXC elec susp	Rear
MK394	MAZDA	04-09	Mazda 3 gen 1 (BK) (EXC MPS, sport susp or AWD	Rear
MK394	MAZDA	01-04	Premacy (Cross border) Gen 1 	Rear
MK394	MAZDA	05-10	Mazda 5 MPV Gen 2 (CR19)	Rear
MK394	MAZDA	11-15	Mazda 5 MPV Gen 3 (CW)	Rear
MK394 (EXC bearings)	FORD	13-'19	Kuga 4x2 & 4x4 SUV (gen 2) DM2, C520	Rear
MK394 (EXC bearings)	VOLVO	07-13	C30 Hatch	Rear
MK394 (EXC bearings)	VOLVO	June'04-Oct'12	S40 Sedan & V50 S/W (EXC T5 (Gen 2)	Rear
MK396	SMART	End 03-07	Roadster Passion Cabriolet & Roadster Pure & Pulse Coupe	Front
MK399	OPEL	July '05-10	Zafira 1.6, 1.8, 1.9CDTi MPV (Exc OPC, Sport & Panoramic) 	Front
MK399 (EXC bearings)	OPEL	Sept'04-09	Astra All (EXC OPC, Elec susp) (model H)	Front
MK399 (EXC bearings)	OPEL	07-10	Astra Twintop 1.8 & 2.0 	Front
MK404	TOYOTA	March'06 -12	RAV4 (XA30) gen 3	Front
MK404	TOYOTA	13-Feb 19	RAV4 (XA40) gen 4	Front

Key
 * See important installation information on inside front cover
 ! Excluding self-leveling suspension
 "... Special order - phone 010 900 1850, 6-12 week waiting period

~ Imported
 # Internal bump stop
 ⊕ Steering damper

- It is recommended that all new shock absorbers are fitted in pairs
- Do not mix gas and non-gas units on the same axle
- **Bold** part numbers indicate heavy-duty shocks
- Underlined part numbers indicate parts not immediately available
- *Italic* part numbers followed by > indicate parts to be discontinued

Mounting kits

Part number [numerical listing]

Part number	Make	Year	Application	Position
MK405 (bearing only)	HYUNDAI	Aug'11-20	Accent IV i25 (RB)	Front
MK405 (bearing only)	HYUNDAI	09-'15	i20 Hatch (PB) gen 1 facelift	Front
MK405 (bearing only)	KIA	July'11-June '17	Picanto 1.0, 1.2 Hatch (TA) gen 2	Front
MK405 (bearing only)	KIA	Nov'11-May 17	Rio 1.2, 1.4, 1.6 gen 3 (UB)	Front
MK408A bearings	HYUNDAI	10-March '16	iX35 4x4 (LM) gen 2	Front
MK408A bearings	HYUNDAI	10-March '16	iX35 4x2 (LM) gen 2	Front
MK408A bearings	KIA	Sept'10-March '16	Sportage 4x2 2.0, 2.4 Gen 3 (SL)	Front
MK408A bearings	KIA	Sept'10-March '16	Sportage 4x4 2.0, 2.4 Gen 3 (SL)	Front
MK410	CHERY	08-on	QQ3 (S11) 0.8, 1.1	Front
MK410	CHEVROLET	03-05	Spark (M100, M150)	Front
MK411	AUDI	Late '12-20	A3 all Gen 3 (8V) Sportback, Quattro, Sport Susp S3 & Elec susp). OE Strut leg outer diam = 50mm	Front
MK411	AUDI	Late '12-20	A3 all Gen 3 (8V) Sportback, Quattro, Sport Susp S3 & Elec susp). OE Strut leg outer diam = 55mm	Front
MK411	AUDI	12-on	A3 Cabriolet Quattro Gen 3 (8V)	Front
MK411	AUDI	June 18 - on	A1 Sportback Gen 2 (GB) 30TFSI (1.0), 35TFSI (1.5), 40TFSI (2.0) Sport susp	Front
MK411 bearing	VOLKSWAGEN	13-19	Golf VII Gti, V5, R, AWD & Sport susp) (5G) elec susp) OE Strut leg outer diam = 50mm	Front
MK411 bearing	VOLKSWAGEN	13-19	Golf VII Gti V5, R, AWD & Sport susp) (5G) elec susp) OE Strut leg outer diam = 55mm	Front
MK411 bearing	VOLKSWAGEN	15-17	Golf SV (Sportsvan) MPV elec susp)	Front
MK411 bearings	VOLKSWAGEN	Feb '18 - on ^(Gti from June '18)	Polo Hatch, Vivo, Sedan & Cross (mk 6, model AW)	Front
MK411 bearings	VOLKSWAGEN	20 - on	Polo 1.6 Sedan (mk 5 facelift)	Front
MK411 bearings	VOLKSWAGEN	19-on	T-Cross SUV (C11)	Front
MK411 bearings	VOLKSWAGEN	20-on	T-Roc SUV electronic susp (A11)	Front
MK411 bearings	VOLKSWAGEN	Oct 16-23	Tiguan 4-Motion AWD & FWD 1.4TSI, 2.0 Tdi, 2.0TSi gen 2 Allspace 7 seater (AD, BW) electronic suspension	Front
MK411 bearings	AUDI	17 - 23	Q2 (35) 1.0, 1.4 (GAB & GAG)	Front
MK411 bearings	AUDI	Oct 18 - on	Q3 1.4, 2.0 4x2 & 4x4 Quattro RS 2.5 sport or elec susp) F3	Front
MK411 bearings	VOLKSWAGEN	18-22	Arteon 4 door Sport coupe (3H7) Std suspension	Front
MK415	BMW	Nov'11-19	1 series 116i, 118i, 120i, 125i & 120d Sport Susp, Elec susp, x-Drive, 135i, M135i & M140i)	Front
MK415	BMW	Nov'11-19	1 series Sport Susp elec susp, x-Drive, M135i & M140i)	Front
MK415	BMW	April '14-on	2 Series 220i, 228i, 230i, 220d elec susp, 235i, M235i, M240i, M2 & Sport Susp)	Front
MK415	BMW	April '14-on	2 Series Sport Susp elec susp & M2)	Front
MK415	BMW	13- Feb 18	3 Series F30 sedan GT Gran Turismo 5 door liftback/hatch, S/W, Sport susp, Elec Susp, X-Drive and M series) Gen 6	Front
MK415	BMW	13- Feb 18	3 Series F30 sedan Sport Susp & F31 S/W std & Sport GT Gran Turismo 5 door liftback/hatch, and M series) Gen 6	Front
MK415	BMW	13-on	F34 Gran Turismo GT 3 series 5 door liftback/hatch Sedan, S/Wagon, Sport susp and M series)	Front
MK415	BMW	13-on	4 Series Coupe, Gran Coupe (liftback) & Cabriolet SDrive Sport susp, M4, Elec susp & Grand Coupe XDrive)	Front
MK415	BMW	13-on	4 Series Coupe, Gran Coupe (liftback) & Cabriolet Sport susp SDrive elec susp, XDrive & M4)	Front
MK415	BMW	13-on	M4 Coupe, Cabriolet & GTS Xdrive	Front
MK416 bearings	MERCEDES-BENZ	Aug'11-18	CLS250 CLS350d, CLS400, CLS500 (W218) AMG)	Front
MK416 bearings	MERCEDES-BENZ	Mid 09-April '16	W212 E200, E250, E250CDi, E300, E350, E400, E500 S/W, Coupe, Cabrio, AMG, sport susp, air susp, elec susp & AWD)	Front
MK416 bearings	MERCEDES-BENZ	Mid 09-April '16	W212 S/Wagon E200, E250, E300, E350, E500 Sedan,, Coupe, Cabrio, AMG, sport susp, air susp, elec susp & AWD)	Front
MK416 bearings	MERCEDES-BENZ	Mid 09-16	C207 Coupe Elec Susp Sedan, S/W, AMG, air susp)	Front
MK416 bearings	MERCEDES-BENZ	Mid 09-16	207 Cabriolet Elec Susp Sedan, S/W, AMG, air susp)	Front
MK418	SMART	14-on	ForFour 0.9 & 1.0 gen 2 Brabus (W453 gen 2)	Front
MK418 bearings	RENAULT	April'13-19	Clio 0.9, 1.2 Sport susp, RS)	Front
MK418 bearings	RENAULT	April'13-19	Clio 1.6 RS Sport	Front
MK418 bearings	RENAULT	13-19	Captur 0.9T, 1.2T, 1.5dci crossover SUV gen 1 (J87, J5, H5)	Front
MK419	BMW	11-17	X3 (F25) 2.0i, 2.8i, 3.0i, 3.5i & 2.0d, 30d Sport susp sDrive & xDrive AWD elec susp)	Front
MK419	BMW	14-Sept 18	X4 (F26) 2.0i, 2.8i, 3.5i, 2.0d & 3.0d. Sport susp xDrive AWD elec susp & M40)	Front
MK421	TOYOTA	Oct'15-21	Aygo hatch gen 2 (AB40) Agya models	Rear
MK421	SUZUKI	11-18	Swift 1.2, 1.4 gen 2 (AZG, FZ, NZ, ZC72S, ZC82S) 1.6 Sport ZC32S & 4WD	Front
MK425 (bearings only)	AUDI	11-19	A6 Sedan & Avant Quattro Air & Elec susp) C7 Typ 4G	Rear
MK426- MK426A	AUDI	07-March'15	TT 1.8T, 2.0T, 3.2 V6 Coupe & Roadster/Cabriolet, Quattro & Sport susp (8J) elec susp & 2.5RS Quattro) (8J)	Rear
MK427 (bearing only)	BMW	Nov'11-19	1 series 116i, 118i, 120i, 125i & 120d Sport Susp elec susp, x-Drive, 135i, M135i & M140i)	Rear
MK431	JAGUAR	99-08	S-Type (X200) elec susp	Front
MK431	JAGUAR	99-08	S-Type (X200) elec susp	Rear

Key





*	See important installation information on inside front cover
!	Excluding self-leveling suspension
...	Special order - phone 010 900 1850. 6-12 week waiting period

~	Imported
#	Internal bump stop
⊕	Steering damper

- It is recommended that all new shock absorbers are fitted in pairs
- Do not mix gas and non-gas units on the same axle
- **Bold** part numbers indicate heavy-duty shocks
- Underlined part numbers indicate parts not immediately available
- *Italic* part numbers followed by > indicate parts to be discontinued

Mounting kits

Part number [numerical listing]

Part number	Make	Year	Application	Position
MK431 (EXCI) bearings	MINI	01-06	Mini One, Cooper, Cooper S, One D (R50, R52, R53 Mk I)	Rear
MK431 (EXCI) bearings	MINI	07-13	Mini One, Cooper, Cooper D, Cooper S, One D (R56,R57 Mk II) (EXCI) cabriolet (R57) & sport	Rear
MK431 (EXCI) bearings	MINI	08-14	Mini Clubman S/Wagon (EXCI) sport (R55) mkl	Rear
MK431 (EXCI) bearings	MINI	11-15	Mini Coupe (R58) & Roadster Cabriolet (R59)	Rear
MK433 (EXCI) bearings	PEUGEOT	17-on	3008 MPV 1.2T, 1.6T, 2.0 Hdi Crossover gen 2 (EXCI) self leveling susp) (P84 / MC, MR, MJ, M4)	Front
MK433 (EXCI) bearings	PEUGEOT	17-on	5008 1.6T MPV gen 2 (P87, MC, MJ, MR, M4)	Front
MK433 (EXCI) bearings	PEUGEOT	14-21	 308 1.2T gen 2 (T9)	Front
MK433 (EXCI) bearings	OPEL	18-on	Grandland & Grandland X 1.6T SUV (A18)	Front
MK433 (EXCI) bearings	CITROEN	19-on	C5 Aircross SUV (A..)	Front
MK433 (EXCI) bearings	PEUGEOT	19-on	Partner panel van 1.2T, 1.5Hdi, 1.6Hdi gen 3, 1000kg payload (K9)	Front
MK434 (EXCI) bearings	NISSAN	July'14-Sept 22	Qashqai SUV 1.2T, 1.5dci, 1.6dci 4x2 and 1.6dci 4x4 (J11)	Front
MK434 (EXCI) bearings	NISSAN	Sept '14-23	X-Trail All gen 3 (T32)	Front
MK434 (EXCI) bearings	RENAULT	Sept 16-22	Megane IV Hatch 1.2T, 1.6, (EXCI) 2.0T GT & 1.8 RS)	Front
MK435 (EXCI) bearings	MERCEDES-BENZ	Sept'10-Sept '15	Vito Van 113, 115, 116, 122 RWD (EXCI) air susp (W639 Gen 2 facelift) (EXCI) AWD	Front
MK435 (EXCI) bearings	MERCEDES-BENZ	July'10-Sept '14	Viano 7 seater MPV 2.2 Cdi, 3.0 Cdi, 3.5V6 (EXCI) air susp (W639 gen 2 facelift) (EXCI) AWD	Front
MK435 (EXCI) bearings	MERCEDES-BENZ	Oct '15 - on	V Class 7 seater MPV minibus V200d, V220d, V250d, V300d (W447 Gen 3) (EXCI) AWD	Front
MK435 (EXCI) bearings	MERCEDES-BENZ	Oct '15 - on	Vito Van 111 (1.6 FWD), 114, 116, 119 (2.2 RWD) (W447 Gen 3) (EXCI) AWD	Front
MK436	AUDI	June 18 - on	A1 Sportback Gen 2 (6B) 30TFSI (1,0), 35TFSI (1,5), 40TFSI (2,0) (EXCI) Sport susp	Rear
MK436 (EXCI) bearings	VOLKSWAGEN	19-on	T-Cross SUV (C11)	Rear
MK436 (EXCI) bearings	VOLKSWAGEN	Feb '18 - on (Gti from June '18)	 Polo Hatch, (EXCI) Vivo, Sedan & Cross (mk 6, model AW)	Rear
MK436 with 11mm mounting holes (EXCI) bearings	VOLKSWAGEN	13-19	Golf VII (EXCI) Gti (EXCI) V5, R, AWD & Sport susp) (5G) (EXCI) elec susp) OE Strut leg outer diam = 55mm	Rear
MK436 with 11mm mounting holes (EXCI) bearings	VOLKSWAGEN	13-19	Golf VII (EXCI) Gti (EXCI) V5, R, AWD & Sport susp) (5G) (EXCI) elec susp) OE Strut leg outer diam = 55mm	Rear
MK436 with 11mm mounting holes (EXCI) bearings	VOLKSWAGEN	15-17	Golf SV (Sportsvan) MPV (EXCI) elec susp)	Rear
MK441	FORD	13-22	Tourneo Custom 8 seater minibus & Transit Custom van (V36X, F3, FY, FZ) FWD	Front
MK441	FORD	13-22	Tourneo Custom 8 seater minibus & Transit Custom van (V36X, F3, FY, FZ) FWD	Front
MK441	FORD	13-22	Tourneo Custom 8 seater minibus & Transit Custom van (V36X, F3, FY, FZ) FWD	Front
MK441	FORD	13-on	Transit van and Bus (EXCI) chassis cab, Gen 4 (V363, FDC, FDD, FED, FFD) RWD	Front
MK441	FORD	13-on	Transit van and Bus (EXCI) chassis cab, Gen 4 (V363, FDC, FDD, FED, FFD) RWD	Front
MK441	FORD	13-on	Transit van and Bus (EXCI) chassis cab, Gen 4 (V363, FDC, FDD, FED, FFD) RWD	Front
MK442 (EXCI) bearings	MITSUBISHI	11-23	ASX SUV gen 1 (GA, W)	Rear
MK442 (EXCI) bearings	MITSUBISHI	June '07-'12	Outlander 2.4 SUV (Gen 2, GS platform) CW5W (EXCI) '10-'12 Facelift models	Rear
MK442 (EXCI) bearings	MITSUBISHI	end'12-April 23	Outlander 2.4 SUV (Gen 3 GF/GG/ZJ/ZK) [Facelift in 2015]	Rear
MK442 (EXCI) bearings	MITSUBISHI	01-06	Lancer 1.6 (EXCI) Evo (CS3A gen 8)	Rear
MK443 (EXCI) bearings	AUDI	11-19	A6 Sedan & Avant (EXCI) Quattro (EXCI) Air & Elec susp) C7 Typ 4G	Rear
MK443 (EXCI) bearings	AUDI	11-early '18	A7 Sportback (EXCI) Quattro (EXCI) Air or elec susp, and S7 or RS7 4.0 V8) 4G8	Rear
MK444 [*Compare orig MK to photos prior to ordering. All (EXCI) bearings]	BMW	End 04-Oct'11	1 Series Inclm Sport Susp, (EXCI) xDrive & 135i Coupe)	Rear
MK444 [*Compare orig MK to photos prior to ordering. All (EXCI) bearings]	BMW	07-12	330i, 335i Cabriolet (EXCI) M3, Coupe) (E93) + 320i, 325i, 335i Coupe (EXCI) M3, Cabrio) (E92)	Rear
MK444 All (EXCI) bearings (Compare MK to photos prior to ordering)	BMW	10-Oct 15	X1 (E84) sDrive FWD & X1 (E84) xDrive AWD	Rear
MK446A	BMW	Nov 15-Oct 22	X1 (F48) sDrive FWD & xDrive AWD 1.8i, 2.0i, 2.0d (EXCI) LWB F49)	Rear
MK446A	BMW	Nov 18-on	X2 (F39) 1.8i, 2.0i sDrive FWD & 2.0d xDrive AWD	Rear
MK446A	BMW	13- Feb 18	 3 Series F30 sedan (EXCI) GT Gran Turismo 5 door liftback/hatch, S/W, Sport susp, Elec Susp, X-Drive and M series) Gen 6	Rear
MK446A	BMW	13- Feb 18	  3 Series F30 sedan Sport Susp & F31 S/W std & Sport (EXCI) GT Gran Turismo 5 door liftback/hatch, and M series) Gen 6	Rear
MK446A	BMW	13-on	4 Series Coupe, Gran Coupe (liftback) & Cabriolet SDrive (EXCI) Sport susp, M4, Elec susp & Grand Coupe XDrive)	Rear

Key



*	See important installation information on inside front cover
!	Excluding self-leveling suspension
"..."	Special order - phone 010 900 1850. 6-12 week waiting period

~	Imported
#	Internal bump stop
⊕	Steering damper

- It is recommended that all new shock absorbers are fitted in pairs
- Do not mix gas and non-gas units on the same axle
- **Bold** part numbers indicate heavy-duty shocks
- Underlined part numbers indicate parts not immediately available
- *Italic* part numbers followed by > indicate parts to be discontinued

Mounting kits

Part number [numerical listing]

Part number	Make	Year	Application	Position
MK446A	BMW	13-on	4 Series Coupe, Gran Coupe (liftback) & Cabriolet Sport susp SDrive (30) elec susp, XDrive & M4	Rear
MK446A	BMW	13-on	M4 Coupe, Cabriolet & GTS (M) Xdrive	Rear
MK446A (30) bearing)	BMW	Nov'11-19	1 series 116i, 118i, 120i, 125i & 120d (M) Sport Susp (30) elec susp, x-Drive, 135i, M135i & M140i)	Rear
MK446A (30) bearing)	BMW	April'14-on	2 Series 220i, 228i, 230i, 220d (30) elec susp, 235i, M235i, M240i, M2 & Sport Susp)	Rear
MK446A (30) bearing)	BMW	April'14-on	2 Series Sport Susp (30) elec susp & M2)	Rear
MK446A (30) bearing)	BMW	April'14-17	2 Series Active Tourer MPV 218i, 220i, 225i, 220d (30) MTech & Sport Susp)	Rear
MK446A (30) bearings)	MINI	14-24	Mini One, Cooper (F56 - 3 door, F55 - 5 door Mk III) (M) cabriolet (F57) & sport (30) JCW GP sport)	Rear
MK446A (30) bearings)	MINI	April 17-on	Mini Countryman SUV Crossover (M) AWD (F60) mklI	Rear
MK446A (30) bearings)	MINI	15-24	Mini Clubman S/Wagon (M) sport (F54) mklI	Rear
MK450	BMW	Nov 15-Oct 22	X1 (F48) sDrive FWD & xDrive AWD 1.8i, 2.0i, 2.0d (30) LWB F49)	Front
MK450	BMW	Nov 18-on	X2 (F39) 1.8i, 2.0i sDrive FWD & 2.0d xDrive AWD	Front
MK450 (M) bearings)	MINI	15-24	Mini Clubman S/Wagon (M) sport (F54) mklI	Front
MK450 (M) bearings)	MINI	April 17-on	Mini Countryman SUV Crossover (M) AWD (F60) mklI	Front
MK450 (M) bearings)	BMW	April'14-17	2 Series Active Tourer MPV 218i, 220i, 225i, 220d (30) MTech & Sport Susp)	Front
MK452 (30) bearings)	MERCEDES-BENZ	12-Aug 18	A180, A200, A200d, A220d, A250 (W176) (30) AMG & Sport susp	Front
MK452 (30) bearings)	MERCEDES-BENZ	April'12-18	B180, B200, B200d, B220d, B250 (W246)	Front
MK452 (30) bearings)	MERCEDES-BENZ	13-19	CLA200, CLA200d, CLA220d, CLA250 (C117) (M) Sport susp, (30) Incr ground clearance, AMG & Elec susp	Front
MK452 (30) bearings)	MERCEDES-BENZ	14-19	GLA200, GLA200d, GLA220d, GLA250 (30) elec susp & AMG gen 1 (X156)	Front
MK454 (M) bearings)	MINI	14-24	Mini One, Cooper (F56 - 3 door, F55 - 5 door Mk III) (M) cabriolet (F57) & sport (30) JCW GP sport)	Front
MK455	HYUNDAI	April 16-22	Tucson All (TL) gen 3	Rear
MK455 (30) bearings)	KIA	April '16 - Sept 22	Sportage 4x2 1.6Gdi Gen 4 (QL)	Rear
MK455 (30) bearings)	KIA	April '16 - Sept 22	Sportage 4x4 2.0, 2.4 Gen 4 (QL)	Rear
MK455 (30) bearings)	HYUNDAI	10-March '16	iX35 4x2 (LM) gen 2	Rear
MK455 (30) bearings)	HYUNDAI	10-March '16	iX35 4x4 (LM) gen 2	Rear
MK456	BMW	13-18	X5 (F15) 3.5i xDrive, 5.0i V8 xDrive, 3.0d xDrive, 4.0d xDrive 4x4, (M) Self Leveling & sport susp (30) Mtech M50d or Elec susp)	Front
MK456	BMW	Feb'15-on	X6 (F16) Cross-over SUV	Front
MK458 (30) bearings)	NISSAN	11-June 18	Micra (K13) gen 4	Front
MK460 (30) bearings)	KIA	July'11-June '17	Picanto 1.0, 1.2 Hatch (TA) gen 2	Front
MK460 (30) bearings)	HYUNDAI	09-'15	i20 Hatch (PB) gen 1 (M) facelift	Front
MK460 (30) bearings)	HYUNDAI	Aug'11-20	  Accent IV i25 (RB)	Front
MK460 (30) bearings)	KIA	Nov'11-May 17	Rio 1.2, 1.4, 1.6 gen 3 (UB)	Front
MK461 (M) bearings)	MAZDA	March'15-on	Mazda 2 (DJ) 1.3, 1.5	Front
MK461 (M) bearings)	MAZDA	Oct'14-June 19	Mazda 3 gen 3 (BM) (30) MPS, sport susp or AWD	Front
MK461 (M) bearings)	MAZDA	13-16	Mazda 6 (30) MPS gen 3 (GJ)	Front
MK461 (M) bearings)	MAZDA	15-on	CX-3 SUV 2.0 (DK)	Front
MK461 (M) bearings)	MAZDA	12-14	CX-5 SUV gen 1 (KE)	Front
MK461 (M) bearings)	MAZDA	14-17	CX-5 SUV gen 1 facelift (KE)	Front
MK462R & MK463L (M) bearing)	NISSAN	11-19	Juke FWD (F15)	Front
MK462R & MK463L (M) bearing)	NISSAN	11-19	Juke AWD (F15)	Front
MK462R & MK463L (M) bearing)	NISSAN	18-23	Leaf (ZE1)	Front
MK464 (M) bearing)	NISSAN	11-19	Juke FWD (F15)	Rear
MK469	HYUNDAI	08-18	i10 Hatch gen 1 (PA)	Front
MK469 (M) bearings)	KIA	04-June'11	Picanto 1.0, 1.1 Hatch (SA / BA) gen 1	Front
MK471	CITROEN	08-14	C1 1.0 & 1.4 Hdi Gen 1 (PM)	Rear
MK471	PEUGEOT	07-15	107 Hatch 1.0	Rear
MK471	TOYOTA	99-05	Yaris / Vitz Hatch (30) 1.5 T-Sport (Cross border - non RSA) gen 1 (XP10)	Rear
MK471	TOYOTA	05 - Sept'11	Yaris Hatch & (Vios) Sedan (NBC2) gen 2 (XP90)	Rear
MK471	TOYOTA	Oct'11- 19	Yaris Hatch 1.0, 1.3 & Sedan gen 3 (XP130)	Rear
MK471 (30) bearings)	TOYOTA	11-Sept'15	Aygo hatch gen 1 (AB10)	Rear
MK472	CHEVROLET	09-18	Cruze J300 (gen one) & J400 (gen two) Sedan & Hatch (M) Sport susp, (30) OPC)	Rear
MK472 (30) bearings)	OPEL	end 10-May 16	 Astra (30) OPC, GTC, Elec susp) (J)	Rear
MK472 (30) bearings)	OPEL	11-18	Astra GTC coupe (M) OPC (J)	Rear
MK475	HYUNDAI	July'12-16	i30 Hatch (GD) gen 2	Front

Key







*	See important installation information on inside front cover
!	Excluding self-leveling suspension
...	Special order - phone 010 900 1850. 6-12 week waiting period

~	Imported
#	Internal bump stop
⊕	Steering damper

- It is recommended that all new shock absorbers are fitted in pairs
- Do not mix gas and non-gas units on the same axle
- **Bold** part numbers indicate heavy-duty shocks
- Underlined part numbers indicate parts not immediately available
- *Italic* part numbers followed by > indicate parts to be discontinued

Mounting kits

Part number [numerical listing]

Part number	Make	Year	Application	Position
MK475	KIA	13-18	Cerato / Forte sedan, hatch & Koup (YD) gen 2	Front
MK475	KIA	14-18	Cerato Koup 1.6T Coupe (YD)	Front
MK476 (EXC) bearings)	MERCEDES-BENZ	12-Aug 18	A180, A200, A200d, A220d, A250 (W176) (EXC) AMG & Sport susp	Rear
MK476 (EXC) bearings)	MERCEDES-BENZ	April '12-18	B180, B200, B200d, B220d, B250 (W246)	Rear
MK478 (EXC) bearings)	FORD	17-22	 Fiesta Sedan & Hatch Mk 7 HJ, HF	Front
MK479 (EXC) bearings)	HYUNDAI	Feb'15-20	i20 Hatch (GB) gen 2 ((EXC) "Active" that has increased ground clearance)	Front
MK479 (EXC) bearings)	HYUNDAI	18-20	i20 Hatch Active Crossover 1.4 (GB) gen 2 (has incr ground clearance) (EXC) i20N	Front
MK479 (EXC) bearings)	KIA	July 17-on	Picanto 1.0, 1.2 Hatch (JA) gen 3	Front
MK483	HYUNDAI	April 16-22	Tucson All (TL) gen 3	Front
MK483 (INC) bearings)	KIA	April '16 - Sept 22	Sportage 4x2 1.6Gdi Gen 4 (QL)	Front
MK483 (EXC) 2.4 (INC) bearings)	KIA	April '16 - Sept 22	Sportage 4x4 2.0, 2.4 Gen 4 (QL)	Front
MK485 (INC) bearings)	FORD	18-21	Figgo Hatch & sedan gen 3	Front
MK485 (INC) bearings)	FORD	Nov 12-17	 Fiesta Sedan & Hatch Mk 6 facelift (EXC) ST	Front
MK485 (INC) bearings)	FORD	13-on	EcoSport cross-over SUV 1.0T, 1.5, 1.5TDCi (Gen 2)	Front
MK485 (INC) bearings)	FORD	Nov'08-Oct '12	Fiesta Sedan & Hatch Mk 6 CB1, CCN (INC) 1.6 ST	Front
MK485 (INC) bearings)	FORD	Dec 15-18	Figgo Hatch & sedan 1.5 gen 2 ((EXC) Freestyle Cross)	Front
MK485 (INC) bearings)	MAZDA	07-Feb'15	Mazda 2 (DE)	Front
MK487 (EXC) bearings)	OPEL	15-April 22	Mokka & Mokka X cross-over SUV FWD ((EXC) AWD) [Facelift Aug '16] gen 1 (J13)	Front
MK488	HYUNDAI	June'14-July '20	Grand i10 Hatch 1,25 gen 2 (BA)	Front
MK489	AUDI	Feb 16-on	 A4 Sedan (INC) Quattro (8W) ((EXC) Sport susp & S4) B9 (53mm btm mtng housing diam)	Front
MK489	AUDI	Feb 16-on	 A4 Sedan (INC) Quattro (8W) Sport susp ((EXC) S4) B9 (48mm btm mtng housing diam)	Front
MK489	AUDI	Feb '16 - on	A5 Sportback Coupe, Cabrio & Quattro ((EXC) RS5) (F5, B9)	Front
MK489	AUDI	Feb 16 - on	S5 Sportback Coupe & Cabrio (INC) A5 Sport Susp, Quattro (EXC) RS5 4.2 V8 (B9)	Front
MK493	AUDI	Feb 16-on	 A4 Sedan (INC) Quattro (8W) ((EXC) Sport susp & S4) B9 (53mm btm mtng housing diam)	Rear
MK493	AUDI	Feb 16-on	 A4 Sedan (INC) Quattro (8W) Sport susp ((EXC) S4) B9 (48mm btm mtng housing diam)	Rear
MK493	AUDI	Feb '16 - on	A5 Sportback Coupe, Cabrio & Quattro ((EXC) RS5) (F5, B9)	Rear
MK493	AUDI	Feb 16 - on	S5 Sportback Coupe & Cabrio (INC) A5 Sport Susp, Quattro (EXC) RS5 4.2 V8 (B9)	Rear
MK494 (INC) bearings)	TOYOTA	04-Oct'09	Corolla Verso MPV (AR10)	Front
MK495	KIA	Nov'09 - '11	Sorento 4x4 & 4x2 gen 2 (XM). (EXC) elec or self-levelling susp	Front
MK495	KIA	12 - Feb'15	Sorento 4x2 gen 2 facelift (XM). (EXC) elec or self-levelling susp	Front
MK495	KIA	12 - Feb'15	Sorento 4x4 gen 2 facelift (XM). (EXC) elec or self-levelling susp	Front
MK496 (INC) bearings)	RENAULT	March'14-20	Sandero 0.9 hatch ((EXC) Stepway) (B8 gen 2)	Front
MK496 (INC) bearings)	RENAULT	March'14-20	Sandero 0.9 Stepway (B8 gen 2)	Front
MK497 (INC) bearings)	SUZUKI	05-20	Grand Vitara 4x4 2.4i, 3.2i gen 3 (JT)	Front
MK498 (INC) bearings)	SUZUKI	End'08-March'14	SX4 2.0 4x2 SUV (EXC) OE raised susp (GY, EY, RW)	Front
MK498 (INC) bearings)	SUZUKI	End'08-March'14	SX4 2.0 4x4 SUV (GY, EY, RW)	Front
MK499	MERCEDES-BENZ	19-22	CLS300, CLS350, CLS5400 (W257) (EXC) AMG)	Front
MK499 (EXC) bearings)	MERCEDES-BENZ	June'14-June '21	W205 C class C180, C200, C220d, C250, C250d, C300 & C350e (EXC) S/Wagon, Elec susp, Self level susp, Coupe, 4-Matic, AMG & Sports susp)	Front
MK499 (EXC) bearings)	MERCEDES-BENZ	End '14-June '21	C Class Coupe C180, C200, C220d, C250, C250CDi, C300, C350 (EXC) Sport susp & AMG)	Front
MK499 (EXC) bearings)	MERCEDES-BENZ	End '14-June '21	C Class Cabrio C200, C220d, C300 (EXC) Sport susp & AMG)	Front
MK499 (EXC) bearings)	MERCEDES-BENZ	15-22	GLC220d, GLC250, GLC250d, GLC300, GLC350 (EXC) Coupe, Elec susp & AMG gen 1 (X253)	Front
MK499 (EXC) bearings)	MERCEDES-BENZ	15-22	 Coupe GLC220d, GLC250, GLC250d, GLC300, GLC350. (EXC) 5 door, Elec susp & AMG gen 1 (C253)	Front
MK499 (EXC) bearings)	MERCEDES-BENZ	May 16 - April 23	W213 E200, E250, E220d, E350d, E400 (EXC) S/W, Coupe, Cabrio, AMG, sport susp, air susp, elec susp)	Front
MK503	AUDI	Late '12-20	A3 all Gen 3 (8V) (INC) Sportback, Quattro, Sport Susp ((EXC) S3 & Elec susp). OE Strut leg outer diam = 50mm	Rear
MK503	AUDI	Late '12-20	A3 all Gen 3 (8V) (INC) Sportback, Quattro, Sport Susp ((EXC) S3 & Elec susp) OE Strut leg outer diam = 55mm	Rear
MK503	AUDI	12-on	A3 Cabriolet (INC) Quattro Gen 3 (8V)	Rear
MK503 (EXC) bearings)	VOLKSWAGEN	18-22	Arteon 4 door Sport coupe (3H7) Std suspension	Rear
MK503 (for OE# 500513353G) (EXC) bearings)	VOLKSWAGEN	13-19	Golf VII (EXC) Gti, V5, R, AWD & Sport susp) (5G) (EXC) elec susp) OE Strut leg outer diam = 50mm	Rear
MK503 (for OE# 500513353G) (EXC) bearings)	VOLKSWAGEN	15-17	Golf SV (Sportsvan) MPV (EXC) elec susp)	Rear
MK503 (for OE# 500513353G) (EXC) bearings)	VOLKSWAGEN	13-19	Golf VII (EXC) Gti, V5, R, AWD & Sport susp) (5G) (EXC) elec susp) OE Strut leg outer diam = 50mm	Rear

Key

*	See important installation information on inside front cover
!	Excluding self-levelling suspension
***	Special order - phone 010 900 1850. 6-12 week waiting period

~	Imported
#	Internal bump stop
⊕	Steering damper

- It is recommended that all new shock absorbers are fitted in pairs
- Do not mix gas and non-gas units on the same axle
- **Bold** part numbers indicate heavy-duty shocks
- Underlined part numbers indicate parts not immediately available
- *Italic* part numbers followed by > indicate parts to be discontinued

Mounting kits

Part number [numerical listing]

Part number	Make	Year	Application	Position
MK509 (MK) bearings)	CITROEN	19-on	C3 Aircross SUV 1,2, 1,6 (2R. 2C)	Front
MK509 (MK) bearings)	OPEL	17-on	Crossland & Crossland X 1,2T SUV (P17)	Front
MK512	KIA	Sept'10-March '16	Sportage 4x2 2.0, 2.4 Gen 3 (SL)	Rear
MK512	KIA	Sept'10-March '16	Sportage 4x4 2.0, 2.4 Gen 3 (SL)	Rear
MK513	BMW	16-on	All G30 5 Series sedan (EX) Sport susp, M-Tech, GT liftback, Touring S/W, elec susp & M5)	Rear
MK514 (MK) bearings)	HYUNDAI	17-18	i30 Hatch gen 3 (PD) (EX) 2.0T i30N performance model	Front
MK514 (MK) bearings)	HYUNDAI	18-23	Kona Cross-over SUV FWD 1.0T, 1.6T-Gdi & 2.0 gen 1 (OS)	Front
MK514 (MK) bearings)	HYUNDAI	July '16-19	Elantra Sedan gen 6 (AD)	Front
MK515 (EX) bearings)	HYUNDAI	18-23	Kona Cross-over SUV FWD 1.0T, 1.6T-Gdi & 2.0 gen 1 (OS)	Rear
MK516 (MK) bearings)	HYUNDAI	Aug'11-June '16	Elantra Sedan gen 5 (MD)	Front
MK516 (MK) bearings)	HYUNDAI	17-Oct 20	Creta SUV gen 1 (GS/GC)	Front
MK517 (EX) bearings)	AUDI	Oct 18 - on	Q3 1.4, 2.0 4x2 & 4x4 Quattro (EX) RS 2.5 sport or elec susp) F3	Rear
MK517 (EX) bearings)	VOLKSWAGEN	20-on	T-Roc SUV (EX) electronic susp (A11)	Rear
MK517 (EX) bearings)	AUDI	17 - 23	Q2 (35) 1.0, 1.4 (GAB & GAG)	Rear
MK519	BMW	16-on	All G30 5 Series sedan (EX) Sport susp, M-Tech, GT liftback, Touring S/W, elec susp & M5)	Front

Key







*	See important installation information on inside front cover
!	Excluding self-levelling suspension
"..."	Special order - phone 010 900 1850. 6-12 week waiting period

~	Imported
#	Internal bump stop
⊕	Steering damper

- It is recommended that all new shock absorbers are fitted in pairs
- Do not mix gas and non-gas units on the same axle
- **Bold** part numbers indicate heavy-duty shocks
- Underlined part numbers indicate parts not immediately available
- *Italic* part numbers followed by > indicate parts to be discontinued

Mounting kits

Part number [numerical listing]

Part number	Make	Year	Application	Position
SPECIAL ORDER				
"905902MM"  "905903MM" 	DODGE	07-11	Nitro SUV AWD	Front
"907994MM"	DODGE	06-12	Caliber 1.8, 2.0 & 2.4 cross-over hatch	Front
"MK006"	SAAB	98-'02	  9.3 2.0 & 2.2TD sedan & coupe  Turbo	Front
"MK006"	SAAB	98-'02	 9.3 Convertible	Front
"MK007"	ALFA ROMEO	94- 97	145 & 146 1.3, 1.6, 1.7 16v	Front
"MK007"	ALFA ROMEO	94- June 01	145 & 146 1.4TS, 1.6TS, 1.8TS, 1.9TDS & 2.0 TS	Front
"MK007"	ALFA ROMEO	91- 97	155  2500 V6, 2.5TD, 2.0 Turbo AWD, elec susp)	Front
"MK007"	ALFA ROMEO	91- 97	155 2500 V6, 2.5TD  elec susp)	Front
"MK012"	PEUGEOT	93-95	405 Sedan & S/Wagon  Sri, Sti, Mi16 & T16)	Front
"MK015"	FORD	98-Sept'01	 Mondeo 1.8 2.0 & 2.5 Si sedan	Front
"MK015"	FORD	98- Sept'01	(S/W) Mondeo 2.0 S/Wagon	Front
"MK032" ('78-81 only)	AUDI	75-Mid 81	80 Sedan & S/Wagon	Front
"MK032"  bearings)	VOLKSWAGEN	81-87	  Passat Sedan & S/Wagon (B2)	Front
"MK038"	OPEL	92- 98	Calibra 2.0 16v & 2.5 V6  Turbo	Front
"MK043"	AUDI	94-July'97	A6 Sedan & Avant  Quattro, Sport susp., & S6)	Front
"MK043"	AUDI	91-94	500 Quattro sport suspension sedan and Avant S/W  S4)	Front
"MK044"	AUDI	83-94	400, 500  Quattro, sport susp & S4)	Front
"MK048"	FIAT	03-10	Multipla MPV 1.6, 1.9JTD  Bi-power)	Front
"MK049"	FIAT	01-06	Seicento 1100	Front
"MK053" (bump rubber only)	FORD	95- 99	 Escort	Front
"MK053" (bump rubber only)	FORD	95- 99	(S/W) Escort S/Wagon	Front
"MK065"  bearings)	OPEL	01-06	Omega 2.2Dti, 2.5 atl, 2.6, 3.0, 3.2  S/Wagon) (V94)	Front
"MK085"	VOLVO	94-96	960 Sedan & S/Wagon (Leaf spring susp)  coil rear suspension	Front
"MK085"	VOLVO	97- 98	S90 Sedan gen 1  elec or self level susp	Front
"MK097"	CITROEN	01-05	Xsara II	Front
"MK097"	CITROEN	01-07	Xsara Picasso MPV	Front
"MK097"	CITROEN	03-April'08	Berlingo Multispace MPV & P/Van	Front
"MK097" (mounting + bearing)	PEUGEOT	99-Nov'02	Partner Grand Raid MPV 2.0 Hdi (DW10TD) gen 1 (600kg payload) (5F)	Front
"MK097" (mounting + bearing)	PEUGEOT	Nov'02-08	Partner Grand Raid MPV 1.9D (DW8B) & 2.0 Hdi (DW10TD) gen 1 (600kg payload) (5F)	Front
"MK097" (Power steering only)	PEUGEOT	98-02	306 Hatch, 1.6 Sedan and S/Wagon	Front
"MK097" (Power steering only)	PEUGEOT	93-97	 306 CC Cabrio	Front
"MK115"	PEUGEOT	95-'04	 406 Sedan  elec susp)	Front
"MK115"	PEUGEOT	96-'04	(S/W) 406 2.0 Estate S/Wagon  elec susp)	Front
"MK115"	PEUGEOT	97-Feb'06	 406 Coupe 3.0  elec susp)	Front
"MK119"	AUDI	83-94	400, 500  Quattro, sport susp & S4)	Rear
"MK119"	AUDI	94-July'97	A6 Sedan & Avant  Quattro, Sport susp., & S6)	Rear
"MK119"	AUDI	94-July'97	A6 Sedan & Avant Quattro  Sport suspension & S6)	Rear
"MK127"	FORD	95- 99	 Escort	Rear
"MK128"	FORD	98-Sept'01	 Mondeo 1.8 2.0 & 2.5 Si sedan	Rear
"MK135"	BMW	94-02	728i, 730d, 735i, 740i & 750i & Limo (E38)  Air Susp. & elec susp)	Front
"MK141"	VOLVO	94- 96	850 Sedan & S/Wagon  Lowered and Nivomat self leveling suspension)	Front
"MK141"  bearings)	VOLVO	97-'00	S70 Sedan  lowerered & Nivomat leveling suspension)	Front
"MK141"  bearings)	VOLVO	97- Feb'00	V70 S/Wagon Gen1  Elec Four-C & Nivomat rears)	Front
"MK147R" & "MK148L"  bearings)	PEUGEOT	99-06	Boxer Van 1.8 ton LWB gen 2	Front
"MK151"	FORD	Sept'01-07	  Mondeo Sedan & Coupe  18" Wheels & Sport susp	Front
"MK151"	FORD	Sept'01-07	(S/W) Mondeo S/Wagon	Front
"MK152R" + "MK153L"	RENAULT	96-'02	Espace (J66 / P52) + Grand Espace (D66) MPV  air susp	Front
"MK154"	RENAULT	99-01	Laguna Sedan (B56 / K56) Check front mounting information for correct strut Shock OE#'s 7700830490 = 11743	Front
"MK154"	RENAULT	99-01	Laguna Sedan (B56 / K56) Check front mounting information for correct strut OE#'s 7700830491 or 7700830492 = 11655	Front

Key















- * See important installation information on inside front cover
- ! Excluding self-leveling suspension
- "..." Special order - phone 010 900 1850. 6-12 week waiting period

- ~ Imported
- # Internal bump stop
- ⊕ Steering damper

- It is recommended that all new shock absorbers are fitted in pairs
- Do not mix gas and non-gas units on the same axle
- **Bold** part numbers indicate heavy-duty shocks
- Underlined part numbers indicate parts not immediately available
- *Italic* part numbers followed by > indicate parts to be discontinued

Mounting kits

Part number [numerical listing]

Part number	Make	Year	Application	Position
SPECIAL ORDER				
"MK154"	RENAULT	95- 00	Laguna S/Wagon (B56 / K56)	Front
"MK161"	TOYOTA	90-00	Previa std & GL (ABS) Rear IRS TCR 11 & 21 (gen 1 XR10, XR20)	Front
"MK185" Angled mountings (incl bearings)	RENAULT	01-07	Laguna II All, incl S/Wagon (X74)	Front
"MK186"	PEUGEOT	95-'04	 406 Sedan EXC elec susp	Rear
"MK187"	AUDI	97-Jan'99	A6 Sedan & Avant EXC 2.7 Turbo, Quattro, Allroad & 4.2 V8) Only up to -> chassis No's 4B#X#070 000	Rear
"MK187"	AUDI	97-April'00	A6 2.7 Turbo EXC Quattro, Allroad & 8 cyl) Up to -> chassis No's 4B#Y#200 000	Rear
"MK187"	AUDI	Feb'99-April'00	A6 Sedan & Avant S/W EXC Quattro, Allroad & 8cyl) INC 2.7 Turbo From chassis No's 4B#X#070 000 -> 4B#Y#200 000	Rear
"MK187"	AUDI	May'00-March'04	A6 Sedan & Avant EXC Quattro, Allroad ,8cyl & Air Susp) From Ch# : 4B#1#000 001 -on	Rear
"MK187" EXC bearings	VOLKSWAGEN	99-05	 Passat Sedan EXC S/W, Sport Susp & 4WD 4-Motion Syncro) (B5)	Rear
"MK187" EXC bearings	VOLKSWAGEN	99-05	 Passat Sedan 2.3 V5 & 2.8 4WD 4-Motion Syncro EXC Sport Susp) (B5)	Rear
"MK196"	CITROEN	April'08-18	Berlingo Multispace MPV & P/Van 800kg to 1000kg payload	Front
"MK196"	CITROEN	05-Oct'10	C4 (Gen 1) 1.6i, 2.0i, 2.0Hdi INC Coupe EXC DS4 & sport susp)	Front
"MK196"	CITROEN	08-12	C4 Picasso MPV INC air susp	Front
"MK196"	CITROEN	12-16	DS5 1.6, 2.0	Front
"MK196"	PEUGEOT	02-10	 (S/W) 307 1.6 & 2.0 hatch & 2.0 S/Wagon EXC cc)	Front
"MK196"	PEUGEOT	March'04-10	 307 CC Cabrio	Front
"MK196"	PEUGEOT	09-18	Partner 1.6, 1.6Hdi Tepee 8 seater gen 2 (B9)	Front
"MK196"	PEUGEOT	09-18	Partner 1.6, 1.6Hdi panel van gen 2, 800 - 1000kg payload (B9)	Front
"MK199"	RENAULT	02 - 14	Espace + Grand Espace 2.0, 2.2dCi, 3.5 V6 MPV	Front
"MK205"	CITROEN	05-Oct'10	C4 (Gen 1) 1.6i, 2.0i, 2.0Hdi INC Coupe EXC DS4 & sport susp)	Rear
"MK205"	PEUGEOT	02-10	 (S/W) 307 1.6 & 2.0 hatch & 2.0 S/Wagon EXC cc)	Rear
"MK205"	PEUGEOT	March'04-10	 307 CC Cabrio	Rear
"MK208" EXC bearings	FIAT	06-09	Croma (generation II)	Front
"MK208" mounting only	SAAB	03-10	  9.3 Sedan 1.9TiD, 2.0 and 2.0T INC Convertible	Front
"MK216"	KIA	03-06	Sorento 4x4 & 4x2 2.5 & 3.5 gen 1 (JC) EXC elec or self-leveling susp	Front
"MK216"	KIA	07-Oct'09	Sorento 4x4 & 4x2 2.5 & 3.8 gen 1(JC) EXC elec or self-leveling susp	Front
"MK227"	HYUNDAI	Aug'00-Oct'06	Elantra Sedan & S/W gen 3 (XD)	Front
"MK227"	HYUNDAI	96- Aug'00	Elantra Sedan & S/W gen 2 (J2)	Front
"MK227" INC bearings	HYUNDAI	02-10	Matrix Mini MPV (FC)	Front
"MK243"	VOLVO	97-05	  C70 Coupe & Cabrio	Front
"MK243"	VOLVO	94- 96	850 Sedan & S/Wagon EXC Lowered and Nivomat self leveling suspension)	Front
"MK257"	MAZDA	94- 99	Etude BH / Astina BA - J55 (RSA Mnf)	Front
"MK267"	HYUNDAI	00-08	Atos & Atos Prime (FF/MX)	Front
"MK269R" & "MK270L"	FIAT	94- Aug'97	Ulysse MPV	Front
"MK269R" & "MK270L"	FIAT	Sept'97-02	Ulysse MPV	Front
"MK269R" & "MK270L"	PEUGEOT	96- Sept'97	806 MPV	Front
"MK269R" & "MK270L"	PEUGEOT	Oct'97-'02	806 MPV	Front
"MK269R" R "MK270L" L	CITROEN	11-16	Dispatch Multispace Minibus & panel van	Front
"MK279"	BMW	Nov'03-May'10	All E60 5 Series sedan EXC Touring S/W, M5 & Sport susp)	Rear
"MK279"	BMW	Nov'03-May'10	All E60 5 Series sedan Sport susp EXC Touring S/W, & M5)	Rear
"MK279"	BMW	04-May'10	All E61 5 Series Touring EXC Sedan, M5 & Sport susp)	Rear
"MK290R" & "MK291L"	SUBARU	98 - May'02	Forester 1 AWD 2.0 & 2.5 EXC Self leveling, elec or air susp) (SF gen 1)	Rear
"MK298"	NISSAN	01 - May'06	 Almera Sedan EXC Hatch (N16) INC ABS	Rear
"MK298"	NISSAN	01-'03	 Almera / Sunny Hatch (N16E)	Rear
"MK302"	FIAT	07-15	Bravo (198 generation II) 1.4, 1.9 EXC sport susp)	Front
"MK302"	FIAT	03-10	Stilo 1.6 Hatch	Front
"MK302"	FIAT	03-10	Stilo 1.8, 1.9 JTD Hatch	Front
"MK302"	FIAT	03-10	Stilo 2.4 Abarth Hatch	Front
"MK302"	FIAT	03-10	Stilo 1.6 Multi Wagon	Front
"MK302"	FIAT	03-10	Stilo 1.9 JTD Multi Wagon	Front
"MK304A"	HYUNDAI	07-09	Santa Fe 4x2 & 4x4 Gen 2 (CM) EXC elec or self-levelling susp)	Front
"MK307"	NISSAN	01 - May'06	 Almera Sedan EXC Hatch (N16) INC ABS	Front

Key

*	See important installation information on inside front cover
!	Excluding self-levelling suspension
"..."	Special order - phone 010 900 1850. 6-12 week waiting period

~	Imported
#	Internal bump stop
⊕	Steering damper

- It is recommended that all new shock absorbers are fitted in pairs
- Do not mix gas and non-gas units on the same axle
- **Bold** part numbers indicate heavy-duty shocks
- Underlined part numbers indicate parts not immediately available
- *Italic* part numbers followed by > indicate parts to be discontinued

Mounting kits

Part number [numerical listing]

Part number	Make	Year	Application	Position
SPECIAL ORDER				
"MK307"	NISSAN	01-'03	Almera / Sunny Hatch (N16E)	Front
"MK308R" & "MK309L"	FIAT	02-June'06	Ducato 10, 14 Van 2.3JTD, 2.8JTD - 1.0 ton & 1.5 ton Gen 2	Front
"MK308R" & "MK309L"	CITROEN	11-18	Jumper Van (Check original front piston rod outer diameters, & original rear open and closed lengths for correct shock selection)	Front
"MK308R" & "MK309L"	FIAT	July'06-on	Ducato SWB & LWB Van & Minibus (Q11, Q15, Q17, Q20) Gen 3	Front
"MK308R" & "MK309L"	FIAT	July'06-on	Ducato SWB & LWB Van & Minibus (Q11, Q15, Q17, Q20) Gen 3	Front
"MK308R" & "MK309L" (incl bearings)	PEUGEOT	99-06	Boxer Van 1.4 ton SWB gen 2	Front
"MK313R" & "MK314L"	FIAT	13-21	Fiorino cargo panel van (327)	Front
"MK313R" & "MK314L"	FIAT	13-17	Qubo mini MPV	Front
"MK313R" & "MK314L"	FIAT	09-14	Linea sedan 1.4 8v T-Jet	Front
"MK315"	MAZDA	99-00	Etude (Ch # up to -> ###304194) - J39 (BJ)	Front
"MK315"	MAZDA	00-00	Etude (Ch ###304195 up to ->###400000) - J39 (BJ)	Front
"MK315"	MAZDA	00-04	Etude (Ch # 's ###400001 - on ->) front 2.0 26v (BJ)	Front
"MK316"	HYUNDAI	01-06	Santa Fe 4x2 & 4x4 Gen 1 (SM)	Rear
"MK319"	PEUGEOT	Mid 04-10	407 Sedan 2.0 ST elec susp	Front
"MK319"	PEUGEOT	Mid 04-10	407 Sedan 2.0 Hdi, 2.2 ST Sport, 3.0 ST Coupe & Elec susp	Front
"MK319"	PEUGEOT	End 04-08	407 S/Wagon 2.0 Hdi, 2.2 Sport, 3.0 Sport elec susp	Front
"MK324" 2.2)	PEUGEOT	3/06 - 10	407 Coupe 2.2, 2.7 Hdi, 3.0 elec susp	Front
"MK338"	HYUNDAI	10/05-9/10	Sonata (NF) gen 5	Front
"MK341" bearings)	PORSCHE	03-10	Cayenne 4x4 SUV (9PA)	Front
"MK341" bearings)	PORSCHE	11-17	Cayenne 4x4 SUV (92A)	Front
"MK342" (bearings only)	FIAT	06-09	Croma (generation II)	Front
"MK342" bearing only	SAAB	03-10	9.3 Sedan 1.9Tid, 2.0 and 2.0T Convertible	Front
"MK344"	SMART	03-07	ForTwo all 700cc cabrio Brabus (W450 gen 1)	Front
"MK344"	SMART	08-14	ForTwo all 1.0 cabrio Brabus (W451 gen 2)	Front
"MK349"	ALFA ROMEO	June'01-10	147 1.6TS, 1.9JTD & 2.0TS hatch	Front
"MK349"	ALFA ROMEO	97-05	156 ALL GTA, Sport susp	Front
"MK349"	ALFA ROMEO	97-05	156 GTA & Sport Susp 3.2 GTA	Front
"MK349"	ALFA ROMEO	00-06	156 Sportwagon GTA / elec susp / self leveling rears)	Front
"MK349"	ALFA ROMEO	99-07	166 3.0 V6 & 3.2 V6 2.0, 2.4, 2.5)	Front
"MK349"	ALFA ROMEO	05-10	2.0 & 1.9JTD & 3.2 V6 GTA	Front
"MK358" 2003)	MAZDA	03-07	Mazda 6 MPS gen 1 (GG)	Front
"MK362"	ALFA ROMEO	05-11	159	Front
"MK369"	SUZUKI	08-10	Swift gen 1 (RS413, RS415, MZ, EZ) AWD & Sport ZC31S	Front
"MK370R" & "MK371L"	MAZDA	94-99	Etude BH / Astina BA - J55 (RSA Mnf)	Rear
"MK376"	VOLVO	06-14	C70 Cabriolet	Rear
"MK383" bearings)	RENAULT	09-14	Laguna III Coupe (X91)	Front
"MK390"	BMW	June'10-16	All F10 5 Series sedan Sport susp & M-Tech GT liftback, F11 Touring S/W, elec susp & M5)	Front
"MK390"	BMW	June'10-16	All F07 Gran Turismo GT 5 Series Liftback Sedan, F11 Touring S/W, xDrive & M5)	Front
"MK395"	PEUGEOT	09-17	3008 MPV Crossover 1.6, 1.6 T, 2.0 Hdi gen 1 self leveling susp) (T8 / OU)	Front
"MK395"	PEUGEOT	11-14	5008 1.6 THP MPV gen 1 (T8)	Front
"MK397"	BMW	June'10-16	All F10 5 Series sedan Sport susp & M-Tech GT liftback, F11 Touring S/W, elec susp & M5)	Rear
"MK410"	DAEWOO	99-03	Matiz hatch M100	Front
"MK432"	JAGUAR	02-09	X-Type (X400) R	Front
"MK439"	MAZDA	07-12	CX-7 SUV (crossover) 4x4	Front
"MK445" bearing)	CITROEN	June'06-Nov'09	C3 (facelift) 1.4, 1.6 (FC / FN)	Front
"MK451"	FIAT	14-18	500L 1.4, 1.6 (5 door) Std 500 models, "X" models, Abarth / sport susp (351 & 352)	Front
"MK473R" & "MK474L"	ALFA ROMEO	10-20	Giulietta (940) All	Front
"MK482" bearings)	OPEL	Sept'04-09	Astra All (OPC, Elec susp) (model H)	Front
"MK482" bearings)	OPEL	07-10	Astra Twintop 1.8 & 2.0	Front
"MK505"	CHEVROLET	03-09	Optra J200	Rear
"MK514"	KIA	20-22	Soul hatch 1.6, 2.0 (SK3)	Front
"MK516"	HYUNDAI	13-17	Veloster 3 door coupe (FS)	Front
"MK639"	SUZUKI	14-16	Splash 1.2 hatch	Front

Key





*	See important installation information on inside front cover
!	Excluding self-leveling suspension
"..."	Special order - phone 010 900 1850. 6-12 week waiting period

~	Imported
#	Internal bump stop
⊕	Steering damper

- It is recommended that all new shock absorbers are fitted in pairs
- Do not mix gas and non-gas units on the same axle
- **Bold** part numbers indicate heavy-duty shocks
- Underlined part numbers indicate parts not immediately available
- *Italic* part numbers followed by > indicate parts to be discontinued

Springs

Part number [numerical listing]

Part number	Make	Year	Application	Position
RS40004	MAZDA	12-21	BT-50 4x4 & Hi-Trail 4x2 gen 2 (PN40, UP, UR) Raised 30mm	Front
RS40013	TOYOTA	June'05-Jan 16	HiLux / Vigo "D4D" 4x4 & Raised body 4x2, gen 7 Raised +-25mm	Front
<i>RS40013 ></i>	TOYOTA	03-Oct '09	Prado J120 (5 door) / J125 (3 door) Series 300 elec susp) Raised +-40mm	Front
RS40014	TOYOTA	April 16 - on	Fortuner SUV 2.4 Raised +-40mm	Front
<i>RS40016 ></i>	MINI	07-16	Triton LDV All 4x4 & 4x2 raised body Std height gen 4 (MN) Raised Susp +-20mm	Front
<i>RS40017 ></i>	NISSAN	05-March 17	Navara 4x2 & 4x4 2.5 dCi, 3.0, 4.0 V6 LDV (D40) Raised +-30mm	Front
<u>RS40019</u>	ISUZU	April '13-'21	KB / D-Max 4X4 P190 / RT50 / RT85 & 4x2 Hi-Rider raised body RT series Raised 30mm to 60mm	Front
RS40040	NISSAN	April 17-on	Navara 4x2 Raised body & 4x4 LDV (D23) 100 '21 facelift Raised +-30mm	Front
RS40041	NISSAN	April 17-on	Navara 4x2 Raised body & 4x4 LDV (D23) 100 '21 facelift Raised +-30mm	Rear
RS40051	TOYOTA	'16-on	Fortuner SUV all gen 2 (AN150/AN160) Raised +-40mm	Rear
<i>RS40054 ></i>	MINI	17-24	Triton LDV All 4x4 & 4x2 raised body Std height gen 5 (MQ) 100 2019 facelift (KJ/KK/KL) Raised Susp +-25mm	Front
SE3288	VOLKSWAGEN	04-Feb'09	Golf V 1.4 & 1.6 300 Gti, V5, R32 & Sport susp) 1K1 OE Strut leg bottom outer diam = 50mm & 55mm	Front
SE3288	VOLKSWAGEN	March'09-13	Golf VI 1.2, 1.4, 1.6 300 1.4 auto, Gti, V5, R32, AWD, Elec & Sport susp)	Front
SE3288	VOLKSWAGEN	March'06-Sept'11	Jetta V 1.6 300 V5 & Sport susp) 1K2 (A5)	Front
SE3290	VOLKSWAGEN	04-Feb'09	Golf V 1.9 & 2.0 300 V5, R32 & Sport susp) 1K1 OE Strut leg bottom outer diam = 50mm & 55mm	Front
SE3290	VOLKSWAGEN	March'09-13	Golf VI 1.4 auto, 1.6TDi, 1.8, 2.0 300 AWD, Elec & Sport susp)	Front
SE3290	VOLKSWAGEN	March'06-Sept'11	Jetta V 1.9 & 2.0 300 V5 & Sport susp) 1K2 (A5)	Front
SE3292	VOLKSWAGEN	04-Feb'09	Golf V 1.4 & 1.6 300 Gti, V5, R32 & Sport susp) 1K1 OE Strut leg bottom outer diam = 50mm	Rear
SE3292	VOLKSWAGEN	March'09-13	Golf VI 300 Gti, V5, R32, AWD, Elec & Sport susp) OE Strut leg bottom outer diam = 50mm	Rear
SE3292	VOLKSWAGEN	March'09-13	Golf VI Gti & R32 100 4-motion AWD 300 elec susp	Rear
SE3292	VOLKSWAGEN	March'09-13	Golf VI All Electronic suspension	Rear
SE3292	VOLKSWAGEN	March'06-Sept'11	Jetta V 1.6 300 V5 & Sport susp) 1K2 (A5). Strut leg bottom outer diam = 50mm	Rear
SE3463	MERCEDES-BENZ	July'10-Sept '14	Viano 7 seater MPV 2.2 Cdi, 3.0 Cdi, 3.5V6 100 air susp (W639 gen 2 facelift) 300 AWD	Front
<u>SE3581</u>	MERCEDES-BENZ	05-12	A170, A180Cdi, A200 (W169)	Rear
<u>SE3581</u>	MERCEDES-BENZ	06-March'12	B170, B200T, B200Cdi (W245)	Rear
SN3407	VOLKSWAGEN	16 - On	Type VI T6 Caravelle, California, Kombi, Transporter van, Crew bus & Van 100 4Motion 4WD 300 elec susp	Rear
SN3464	MERCEDES-BENZ	06-June'10	Viano 7 seater MPV 2.2 Cdi, 3.0 Cdi, 3.5V6 100 air susp (W639 gen 2)	Rear
SN3464	MERCEDES-BENZ	July'10-Sept '14	Viano 7 seater MPV 2.2 Cdi, 3.0 Cdi, 3.5V6 100 air susp (W639 gen 2 facelift) 300 AWD	Rear
SN3464	MERCEDES-BENZ	04-Aug'10	Vito Minibus & Van 109Cdi, 111Cdi, 115Cdi, 119, 120Cdi, 122, 123, 126 (3.5) RWD 100 air susp (W639 Gen 2)	Rear
SN3464	MERCEDES-BENZ	Sept'10-Sept '15	Vito Van 113, 115, 116, 122 RWD 100 air susp (W639 Gen 2 facelift) 300 AWD	Rear
SN3619	BMW	04-10	X3 (E83) 2.5, 3.0 & 2.0 d 100 Sport susp 300 elec susp)	Rear
SP 3579	MERCEDES-BENZ	05-12	A170 & A200 Auto + A180Cdi Manual (W169)	Front
SP0014	VOLKSWAGEN	85-93	Golf II & Jetta II 300 Gti)	Front
SP0014	VOLKSWAGEN	92-94	Golf III & Jetta III 300 Gti, VR6)	Front
SP0020	OPEL	Nov'99-Sept'04	Astra hatch & Classic sedan & S/W 1.6 (G) 300 OPC)	Front
SP0024	VOLKSWAGEN	78-92	Golf I / Jetta I & Citi 100 Fox, CTi, ShuttleTrippa & Cabriolet	Front
SP0024	VOLKSWAGEN	93-10	CITI - 300 Sonic, Life, VeloCiti & Rox (Seated Strut)	Front
SP0068	AUDI	95- Jan'99	 A4 Sedan 300 Quattro, Sport) 8D, B5	Front
SP0068	AUDI	96- Jan'99	 A4 Avant 300 Quattro, Sport) 8D, B5	Front
SP0068	AUDI	Feb'99-Nov'00	 A4 Sedan 300 Sport susp, Avant S/W & Quattro) B5, 8D	Front
SP0068	AUDI	Feb'99-Nov'00	 A4 Avant 300 Sport susp, sedan & Quattro) B5, 8D	Front
<i>SP0069 ></i>	BMW	84-91	316, 318 (E30) 300 IS & cabrio (51mm strut OD)	Front
SP0085	BMW	84-91	320, 323, 325 (E30) 300 IS & cabrio (51mm strut OD)	Front
SP0100	BMW	91-99	316, 318 100 Cabrio. 300 M. Tech. (E36)	Front
SP0100	BMW	91-92	316, 318 300 M. Tech. (E36)	Front
SP0100	BMW	93-99	316, 318 Cabriolet 300 M Tech) (E36)	Front
SP0115	TOYOTA	95-00	RAV4 (5 door) Type SXA 10 & 11 300 235/60R 16" wheels) gen 1	Front
<i>SP0135 ></i> <i>"SE0135"</i>	RENAULT	96-Feb'04	Scenic 1.4 & 1.6 Manual 300 RX4)	Front
SP0145	FIAT	90-'09	Uno 300 Turbo, 1.4 57kw Pacer & raised body "Way" version from Brazil)	Front
<i>SP0202 ></i>	OPEL	Mid 85-88	Kadett & Monza Sedan 2.0 "T car" (E) 100 Gsi & Cabriolet	Front
<i>SP0202 ></i>	OPEL	89-92	Kadett & Monza Sedan 2.0 (InclGsi 2.0) (F.W.D) "T car" (E)	Front
<i>SP0254 ></i>	OPEL	93- Oct'99	Kadett & Astra 1.4 & 1.6 300 S/W) (F)	Front
SP0256	FORD	97- Mid 99	Fiesta 300 Power steering) Mk4 (JA, JB)	Front
SP0256	FORD	Mid 99 -03	Fiesta 300 RSi) Mk4 facelift (JA, JB)	Front

Key











*	See important installation information on inside front cover
!	Excluding self-leveling suspension
"..."	Special order - phone 010 900 1850. 6-12 week waiting period

~	Imported
#	Internal bump stop
⊕	Steering damper

- It is recommended that all new shock absorbers are fitted in pairs
- Do not mix gas and non-gas units on the same axle
- **Bold** part numbers indicate heavy-duty shocks
- Underlined part numbers indicate parts not immediately available
- *Italic* part numbers followed by > indicate parts to be discontinued

Springs

Part number [numerical listing]

Part number	Make	Year	Application	Position
SP0256	FORD	00-06	Ikon sedan All	Front
SP0300	VOLVO	95- May'99	S40 Sedan & V40 S/W (EXC) Sport & T4	Front
SP0313	OPEL	01-Sept'04	Astra hatch & Classic sedan & S/W 2.0 (G) (EXC) OPC	Front
SP0335 > SE0335	AUDI	98-April'03	A3 1.8 & 1.8T turbo, 1.9TDi (EXC) Sport Susp, Quattro & S3	Front
SP0376	VOLKSWAGEN	95-99	Golf III & Jetta III – 1.4 & 1.6 (EXC) VR6, Gti & Cli	Front
SP0405 >	OPEL	Mid 85-88	  Kadett & Monza Sedan "T car" (E) (EXC) 2.0	Rear
SP0405 >	OPEL	89-92	  Kadett & Monza Sedan (M2) Cub (EXC) 2.0 (F.W.D) "T car" (E)	Rear
SP0426 > "SN0406"	VOLKSWAGEN	90- July'04	Type IV Caravelle T4 (M2) 2.5 Tdi, Transporter & Syncro 4WD (front engine)	Rear
SP0429	VOLKSWAGEN	85-93	Golf II & Jetta II (EXC) Gti	Rear
SP0429	VOLKSWAGEN	92-94	Golf III & Jetta III (EXC) Gti & VR6	Rear
SP0433	FORD	85-91	Laser & Meteor All (KC, KE)	Rear
SP0433	FORD	92 - 02	Laser & Meteor All (M2) Tracer (KF, KH)	Rear
SP0433	MAZDA	85-91	323 (M2) EGi F.W.D (BF 6th gen)	Rear
SP0433	MAZDA	92-'03	323 All InclMidge & Sting (BF 6th gen)	Rear
SP0457 >	TOYOTA	96-Oct'02	 Corolla Sedan P160 gen 7 (EXC) Rsi & Rxi (E100, AE101)	Rear
SP0480	BMW	84-91	 318i, 320i, 323i & 325i (E30) (EXC) iS & cabrio (51mm strut OD)	Rear
SP0498	BMW	91-99	316i, 318i, 318is, 318tds, 320i, 323i, 325i, 325td, 325tds, 328i Imported & Local Strut. (M2) Cabrio. (EXC) M. Tech. (E36)	Rear
SP0498	BMW	91-92	320i, 325i & 325td Imported (EXC) M. Tech. (E36)	Rear
SP0498	BMW	93-99	 323i, 325i & 328i Cabriolet (EXC) M Tech (E36)	Rear
SP0502	NISSAN	92- 7/01	Sentra 140 (B13 Sunny)	Rear
SP0502	NISSAN	92- 7/01	Sentra & Sabre 160 (B13 Sunny)	Rear
SP0502	NISSAN	92- 7/01	Sentra & Sabre 200 (EXC) ABS (B13 Sunny)	Rear
SP0509	FORD	97- Mid 99	Fiesta (EXC) Power steering) Mk4 (JA, JB)	Rear
SP0509	FORD	Mid 99 -03	Fiesta (EXC) RSi) Mk4 facelift (JA, JB)	Rear
SP0509	FORD	00-06	Ikon sedan All	Rear
SP0539	FIAT	90-'09	Uno (EXC) Turbo & 1.4 57kwPacer, & raised body "Way" version from Brazil)	Rear
SP0566	VOLVO	95- May'99	V40 S/W (EXC) Sport & T4	Rear
SP0604 > SE0604	VOLKSWAGEN	99-04 (Jetta till 2/06)	Golf IV & Jetta IV 1.6 only (EXC) Estate S/W) 20mm rod	Rear
SP0604 > SE0604	VOLKSWAGEN	99-04 (Jetta till 2/06)	Golf IV & Jetta IV 1.8, Gti Turbo, 1.9 Tdi, 2.0, 2.3 V5 (EXC) Estate S/W & 1.6) 22mm rod	Rear
SP0604 > SE0604	VOLKSWAGEN	99-05	Golf IV 1.6 Estate S/Wagon	Rear
SP0604 > SE0604	VOLKSWAGEN	00-05	Golf IV 1.9 Tdi Estate S/Wagon	Rear
SP0653	AUDI	98-April'03	A3 1.8 & 1.8T turbo, 1.9TDi (EXC) Sport Susp, Quattro & S3	Rear
SP0675	AUDI	95- Jan'99	 A4 Sedan (EXC) Quattro, Sport) 8D, B5	Rear
SP0675	AUDI	Feb'99-Nov'00	 A4 Sedan (EXC) Sport susp, Avant S/W & Quattro) B5, 8D	Rear
SP0709	VOLKSWAGEN	98-Sept'02	Polo Playa Hatch (mk 3 6N) (EXC) sport susp	Rear
SP0718 >	VOLVO	95- May'99	S40 Sedan (EXC) Sport & T4	Rear
SP0772	TOYOTA	96-June'06	Conquest / Tazz 1.3 (EE90, AE92)	Front
SP0772 >	TOYOTA	89-96	Corolla & Conquest 1.3 F.W.D P140 (EE90, AE92, CE90)	Front
SP0910	VOLKSWAGEN	95-99	Golf III & Jetta III 1.8 (EXC) VR6	Front
SP1156	FORD	04-Oct'08	 Fiesta Sedan & Hatch Mk 5 JH, JD (M2) 2.0ST (EXC) 2.5 ST or RS)	Rear
SP1156	FORD	10-Nov 15	Figo Hatch 1.4 gen 1	Rear
SP1156	FORD	07-15	Ikon sedan All	Rear
SP1228	HONDA	96- March'01	Ballade & Civic (EXC) 1.6 16v Vtec (EJ9, EK1, EK3, EK4) Mk6	Front
SP1442	MERCEDES-BENZ	94- Aug'00	C280 & C250td (EXC) Sport susp S/Wagons) (W202)	Front
SP1442	MERCEDES-BENZ	94 - Aug'01	C250td, C280 S/Wagon, (EXC) Sport susp (W202)	Front
SP1445	MERCEDES-BENZ	94- Aug'00	C180, C200, C220, C230 & C240 (EXC) C250Td, C280, Sport susp & S/Wagon) (W202)	Rear
SP1445	MERCEDES-BENZ	94- Aug'00	C250td & C280 (EXC) Sport susp S/Wagons) (W202)	Rear
SP1445	MERCEDES-BENZ	Sept'00-April'07	C180, C180K, C200, C200K, C220Cdi, C230, C230K, C240, C280, C320Cdi, C350 & C270CDI (W203) (C203) (EXC) S/Wagon, AMG, Coupe & Sports susp)	Rear
SP1448	MERCEDES-BENZ	94- Aug'00	C180, C200, C220, C230 & C240 (EXC) C250Td, C280, Sport susp & S/Wagon) (W202)	Front
SP1448	MERCEDES-BENZ	94 - Aug'01	C180, C200, C220, C230 & C240 S/Wagon, (EXC) Sport susp (W202)	Front

Key

*	See important installation information on inside front cover
!	Excluding self-levelling suspension
"..."	Special order – phone 010 900 1850. 6-12 week waiting period

~	Imported
#	Internal bump stop
⊕	Steering damper

- It is recommended that all new shock absorbers are fitted in pairs
- Do not mix gas and non-gas units on the same axle
- **Bold** part numbers indicate heavy-duty shocks
- Underlined part numbers indicate parts not immediately available
- *Italic* part numbers followed by > indicate parts to be discontinued

Springs

Part number [numerical listing]

Part number	Make	Year	Application	Position
SP1730 >	RENAULT	95-'02	Megane Hatch & '96-'03 Classic Sedan (EXC 2.0 16v)	Front
SP1730 >	RENAULT	96-May'04	Megane Coupe (EXC 2.0 16v)	Front
SP1734 SP2959	LAND ROVER	84-16	110 Defender SW & 130" Double Cab LDV (L316 & L317) H/Duty (EXC '90	Front
SP1948 >	TOYOTA	97-'02	Prado J90 series 3 door SWB S/W (EXC eye/eye rear mountings) std ht	Rear
SP1950 >	TOYOTA	97-'02	Prado J95 series 5 door LWB S/W (EXC eye/eye rear mountings) std ht	Rear
SP2090 > SE2090	VOLKSWAGEN	99-04 Jetta till 2/06	Golf IV & Jetta IV 20mm & 22mm rod (EXC Gti, Tdi and 2.3 V5)	Front
SP2186	TOYOTA	89-96	Corolla & Conquest 1.6 & 1.8 F.W.D P140 (EE90, AE92, CE90)	Front
SP2186	TOYOTA	96-June'06	Conquest / Tazz 1.6 & 1.8 (EE90, AE92)	Front
SP2201	HONDA	96- March'01	Ballade & Civic (EXC 1.6 16v Vtec (EJ9, EK1, EK3, EK4) Mk6	Rear
SP2215 >	RENAULT	95-'02	Megane Hatch 2.0 16v (EXC Sedan)	Front
SP2215 >	RENAULT	96-May'04	Megane Coupe 2.0 16v	Front
SP2229	KIA	03-06	Sorento 4x4 & 4x2 2.5 & 3.5 gen 1 (JC) (EXC elec or self-leveling susp	Rear
SP2229	KIA	07-Oct'09	Sorento 4x4 & 4x2 2.5 & 3.8 gen 1(JC) (EXC elec or self-leveling susp	Rear
SP2274	BMW	99 - Sept'01	318i (E46) (EXC M3, cabrio, coupe, & sport susp)	Front
SP2274	BMW	Sept'01- Feb'05	318i (E46) (EXC Compact, M3, cabrio, coupe, sport susp & S/W)	Front
SP2274	BMW	Nov'01-05	318ti Compact (E46) (EXC Sport susp	Front
SP2274	BMW	00- 05	318i Touring (E46) (EXC Sport susp)	Front
SP2275	BMW	99 - Sept'01	320d (E46) (EXC M3, cabrio, coupe, & sport susp)	Front
SP2275	BMW	99 - Sept'01	320i, 323i, 325i & 328i (E46) (EXC M3, cabrio, coupe & sport susp)	Front
SP2275	BMW	Sept'01- Feb'05	320i, 320d, 325i (E46) (EXC Compact, M3, cabrio, coupe & sport susp)	Front
SP2275	BMW	Nov'01-05	325ti Compact (E46) (EXC Sport susp	Front
SP2275	BMW	00-05	320i, 325i Touring (E46) (EXC Sport susp)	Front
SP2275	BMW	99-Sept'01	325Ci Coupe (EXC Sport Pac II & M3) (E46)	Front
SP2275	BMW	Oct'01-06	325Ci, 330 Ci Coupe (EXC Sport Pac II & M3) (E46)	Front
SP2277 > SN2277	BMW	99 - Sept'01	318i & 320d (E46) (EXC M3, cabrio, coupe, & sport susp)	Rear
SP2277 > SN2277	BMW	99 - Sept'01	320i, 323i, 325i & 328i (E46) (EXC M3, cabrio, coupe & sport susp)	Rear
SP2277 > SN2277	BMW	99- April'01	330i & 330d (E46) (EXC M3, cabrio, coupe & sport)	Rear
SP2277 > SN2277	BMW	Sept'01- Feb'05	318i (E46) (EXC Compact, M3, cabrio, coupe, sport susp & S/W)	Rear
SP2277 > SN2277	BMW	Sept'01- Feb'05	320i, 320d, 325i (E46) (EXC Compact, M3, cabrio, coupe & sport susp)	Rear
SP2277 > SN2277	BMW	April'01- Feb'05	330i & 330d (E46) (EXC 325ti compact (EXC M3, cabrio, coupe ,sport susp & S/W)	Rear
SP2277 > SN2277	BMW	Nov'01-05	318ti Compact (E46) (EXC Sport susp	Rear
SP2277 > SN2277	BMW	Nov'01-05	325ti Compact (E46) (EXC Sport susp	Rear
SP2277 > SN2277	BMW	00-06	330Ci Cabriolet (EXC Sport Pac II & M3) (E46)	Rear
SP2277 > SN2277	BMW	99-Sept'01	325Ci, 330Ci Coupe (EXC Sport Pac II & M3) (E46)	Rear
SP2277 > SN2277	BMW	Oct'01-06	325Ci, 330 Ci Coupe (EXC Sport Pac II & M3) (E46)	Rear
SP2282	BMW	99- April'01	330i & 330d (E46) (EXC M3, cabrio, coupe & sport)	Front
SP2282	BMW	April'01- Feb'05	330i & 330d (E46) (EXC 325ti compact (EXC M3, cabrio, coupe ,sport susp & S/W)	Front
SP2282	BMW	00-06	330Ci Cabriolet (EXC Sport Pac II & M3) (E46)	Front
SP2282	BMW	99-Sept'01	330Ci Coupe (EXC Sport Pac II & M3) (E46)	Front
SP2282	BMW	Oct'01-06	330 Ci Coupe (EXC Sport Pac II & M3) (E46)	Front
SP2347	CITROEN	02-May'06	C3 1.4i, 1.6i manual. (EXC 1.6 auto, Hdi 80kw & 82kw 51mm OD strut base (FC / FN)	Front
SP2347	CITROEN	02-May'06	C3 1.6i 16v auto & Hdi 80kw & 82kw (EXC 46mm OD strut base. (FC / FN)	Front
SP2347	CITROEN	June'06-Nov'09	C3 (facelift) 1.4, 1.6 (FC / FN)	Front
SP2351	CITROEN	02-May'06	C3 1.4i, 1.6i manual. (EXC 1.6 auto, Hdi 80kw & 82kw 51mm OD strut base (FC / FN)	Rear
SP2351	CITROEN	02-May'06	C3 1.6i 16v auto & Hdi 80kw & 82kw (EXC 46mm OD strut base. (FC / FN)	Rear
SP2351	CITROEN	June'06-Nov'09	C3 (facelift) 1.4, 1.6 (FC / FN)	Rear
SP2453	FORD	03-Oct'04	Focus 1.6 Hatch & Sedan Mkl DAW (EXC 2.0 & St170)	Rear

Key







	See important installation information on inside front cover
	Excluding self-leveling suspension
	Special order - phone 010 900 1850. 6-12 week waiting period

	Imported
	Internal bump stop
	Steering damper

- It is recommended that all new shock absorbers are fitted in pairs
- Do not mix gas and non-gas units on the same axle
- **Bold** part numbers indicate heavy-duty shocks
- Underlined part numbers indicate parts not immediately available
- *Italic* part numbers followed by > indicate parts to be discontinued

Springs

Part number [numerical listing]

Part number	Make	Year	Application	Position
SP2457	FORD	03-Oct'04	Focus 1.6 Hatch & Sedan Mk1 DAW (EXC) 2.0 & St170)	Front
SP2461 > SE2461	FORD	04-Oct'08	Fiesta Sedan & Hatch Mk 5 JH, JD (EXC) 2.5 ST or RS)	Front
SP2461 > SE2461	FORD	10-Nov 15	Figgo Hatch 1.4 gen 1	Front
SP2461 > SE2461	FORD	07-15	Ikon sedan All	Front
SP2505	HYUNDAI	July'00-05	 Accent II (LC)	Front
SP2509 >	HYUNDAI	Aug'00-Oct'06	Elantra Sedan (EXC) S/W gen 3 (XD)	Rear
SP2534 >	HYUNDAI	Aug'00-Oct'06	Elantra 1.6 & 1.8 Sedan & S/W gen 3 (XD)	Front
SP2535 >	HYUNDAI	Aug'00-Oct'06	Elantra 2.0 Sedan & S/W gen 3 (XD)	Front
SP2607	MAZDA	99- 00	Etude (Ch # up to -> ###304194) - J39 (BJ)	Rear
SP2607	MAZDA	00 - 00	Etude (Ch ###304195 up to ->###400000) - J39 (BJ)	Rear
SP2607	MAZDA	00-04	Etude (Ch # 's ###400001 - on ->) (EXC) front 2.0 26v (BJ)	Rear
SP2617	MERCEDES-BENZ	95-July'02	W210 E200, E240, E280, E320 Avantgarde, Classic & Elegance (Heavy Duty). (EXC) S/W, Sport & Elec susp)	Rear
SP2617	MERCEDES-BENZ	95-July'02	W210 E230, E270 Avantgarde, Classic & Elegance (Heavy Duty) (EXC) S/W & Elec susp)	Rear
SP2621	MERCEDES-BENZ	95-July'02	W210 E240, E280, E320 Classic & Elegance Std. Susp. (EXC) S/W, Sport & Elec susp)	Front
SP2654	MITSUBISHI	91- 99	Pajero 4x4 gen 2 V Series: V4 & 2.8TD (V46W) coil rear (NH, NJ, NK, NL) (EXC) elec susp)	Rear
SP2656	MITSUBISHI	91- 99	Pajero 4x4 gen 2 V Series: V2 2.5TD (V24C, V24W) coil rear (NH, NJ, NK, NL) (EXC) elec susp)	Rear
SP2739	NISSAN	01 - May'06	 Almera Sedan (EXC) Hatch (N16) (EXC) ABS	Rear
SP2750	NISSAN	92- 7/01	Sentra & Sabre 160 (B13 Sunny)	Front
SP2750	NISSAN	92- 7/01	Sentra & Sabre 200 (EXC) ABS (B13 Sunny)	Front
SP2755	NISSAN	01 - May'06	Almera Sedan 2.2 (EXC) Hatch (N16) (EXC) ABS	Front
SP2756	NISSAN	01 - May'06	Almera Sedan 1.6, 1.8, 1.5dCi (EXC) Hatch (N16) (EXC) ABS	Front
SP2788	OPEL	End 02-Oct'07	Corsa Hatch & Classic (sedan) (EXC) Lite, Sport & Gsi) (C)	Rear
SP2792 > "SE2792"	OPEL	End 02-Oct'07	Corsa Hatch & Classic (sedan) 1.2 (EXC) Lite) (C)	Front
SP2794	OPEL	End 02-Oct'07	Corsa Hatch & Classic (sedan) 1.4 & 1.6 (EXC) Lite) (C)	Front
SP2862	OPEL	Sept'04-09	Astra 1.4 & 1.6 (model H)	Front
SP2866	OPEL	Sept'04-09	Astra 1.9 CDTi (EXC) GTC (EXC) elec susp (model H)	Front
SP2866	OPEL	Sept'04-09	Astra 2.0 Turbo Sport (EXC) GTC  (EXC) OPC, Elec susp) (model H)	Front
SP2868	OPEL	Sept'04-09	Astra 1.4 & 1.6 (model H)	Rear
SP2868	OPEL	Sept'04-09	Astra 1.8, & 1.9 CDTi (EXC) GTC (EXC) elec susp (model H)	Rear
SP2868	OPEL	Sept'04-09	Astra 2.0 Turbo Sport (EXC) GTC  (EXC) OPC, Elec susp) (model H)	Rear
SP2918	RENAULT	03-08	Megane II Hatch All (EXC) Shake it (EXC) 2.0 T Sport, Sedan)	Rear
SP2920	RENAULT	03-08	Megane II Sedan & Hatch All (EXC) Shake it (EXC) 1.9 & 2.0, 2.0 T Sport)	Front
SP3109	TOYOTA	95-98	RAV4 Type SXA 10 & 11 (EXC) sealed struts & 235/60R 16" wheels) gen 1	Rear
SP3109	TOYOTA	98-00	RAV4 Type SXA 10 & 11 Sealed front struts (EXC) 235/60R 16" wheels) gen 1	Rear
SP3161	TOYOTA	89-96	 Corolla & Conquest (EXC) Twin Cam & 1800 F.W.D P140 (EE90, AE92, CE90)	Rear
SP3161	TOYOTA	96-June'06	 Conquest / Tazz (EE90, AE92)	Rear
SP3177	VOLKSWAGEN	98-Sept'02	Polo Playa Hatch & Classic Sedan (mk 3 6N) (EXC) sport susp	Front
SP3231	CHEVROLET	03-11	Aveo gen one & two (T200 & T250 facelift)	Front
SP3232	CHEVROLET	03-11	Aveo gen one & two (T200 & T250 facelift)	Rear
SP3271 R SP3272 I	LAND ROVER	84-16	90, 110 Defender SW & 130" Double Cab LDV (L316 & L317) H/Duty (EXC) '90	Rear
SP3287	VOLKSWAGEN	04 - May 15	Caddy All gen 3 (2K) (check front strut OD for correct part) 50mm OD strut tube	Front
SP3287	VOLKSWAGEN	04 - May 15	Caddy All gen 3 (2K) (check front strut OD for correct part) 55mm OD Strut tube	Front
SP3293	VOLKSWAGEN	04-Feb'09	Golf V 1.9 & 2.0 (EXC) Gti, V5, R32 & Sport susp) 1K1 OE Strut leg bottom outer diam = 50mm	Rear
SP3300	OPEL	Nov'99-Sept'04	Astra hatch & Classic sedan 1.8 & 2.0 (G) (EXC) OPC & S/W)	Rear
SP3314	MERCEDES-BENZ	Sept'00-April'07	C180, C180K, C200, C200K, C220Cdi, C230, C230K, C240, C280, C320Cdi, C350 & C270CDI (W203) (EXC) S/Wagon (C203) (EXC) AMG, Coupe & Sports susp)	Front
SP3339	MAZDA	99- 00	Etude (EXC) 2.0 (Ch # up to -> ###304194) - J39 (BJ)	Front
SP3339	MAZDA	00 - 00	Etude (EXC) 2.0 (Ch ###304195 up to ->###400000) - J39 (BJ)	Front
SP3339	MAZDA	00-04	Etude (EXC) 2.0 (Ch # 's ###400001 - on ->) (EXC) front 2.0 26v (BJ)	Front
SP3357	HONDA	March'01-05	Civic Vtec 4 door Sedan (ES) Mk7 (EXC) 1.3)	Front
SP3357	HONDA	March'01-05	Civic Vtec 5 door hatch (EP, EU) Mk7 1.4, 1.5, 1.6, 1.7i (EXC) 1.3)	Front
SP3357	HONDA	March'01-05	Civic Vtec 5 door hatch (EP, EU) Mk7 1.3, 1.4, 1.5, 1.6, 1.7i & 1.7D (EXC) 2.0 & Type R)	Front

Key







*	See important installation information on inside front cover
!	Excluding self-levelling suspension
"..."	Special order - phone 010 900 1850. 6-12 week waiting period

~	Imported
#	Internal bump stop
⊕	Steering damper

- It is recommended that all new shock absorbers are fitted in pairs
- Do not mix gas and non-gas units on the same axle
- **Bold** part numbers indicate heavy-duty shocks
- Underlined part numbers indicate parts not immediately available
- *Italic* part numbers followed by > indicate parts to be discontinued

Springs

Part number [numerical listing]

Part number	Make	Year	Application	Position
SP3358	HONDA	March'01-05	Civic Vtec 3 door hatch (EP, EU) Mk7 1.3, 1.4, 1.5, 1.6, 1.7i	Rear
SP3358	HONDA	March'01-05	Civic Vtec 5 door hatch (EP, EU) Mk7 1.3, 1.4, 1.5, 1.6, 1.7i (30) 2.0 & Type R) & 1.7D	Rear
SP3359	HONDA	03-04	Jazz 1.4 Dsi & 1.5 Vtec gen 1 (GD)	Front
SP3359	HONDA	05-07	Jazz 1.4 Dsi & 1.5 Vtec gen 1 (GD facelift)	Front
SP3360	HONDA	03-04	Jazz 1.4 Dsi & 1.5 Vtec gen 1 (GD)	Rear
SP3360	HONDA	05-07	Jazz 1.4 Dsi & 1.5 Vtec gen 1 (GD facelift)	Rear
SP3364	AUDI	Dec'00-04	 +  A4 Sedan & Avant (ExclQuattro, Sport Susp, S4, & RS4) B6. 8E	Front
SP3381	AUDI	Dec'00-04	 +  A4 Sedan & Avant (30) Quattro, Sport Susp, S4, & RS4) B6. 8E	Rear
<i>SP3387 > SE3387</i>	VOLKSWAGEN	Oct'02-Jan'10	Polo Hatch & Classic Sedan (30) Gti, Sport susp & CrossPolo (mk 4 9N3)	Front
<i>SP3388 ></i>	VOLKSWAGEN	Feb'10-Feb '18	Polo VIVO (30) GT) (mk 4 9N3) (30) Maxx	Rear
SP3391	CITROEN	05-Oct'10	C4 (Gen 1) 1.6i, 2.0i, 2.0HDI (30) Coupe (30) DS4 & sport susp)	Front
SP3391	CITROEN	Nov'10-16	C4 (Gen 2) 1.6i, 2.0, 2.0 HDi (30) DS4 & sport susp)	Front
SP3405	VOLKSWAGEN	Aug'04 - 15	Type V Caravelle, Kombi, Crew bus, Transporter LCV & Van T5 (30) 4Motion 4WD (front engine) (30) front struts with bottom camber brackets	Front
<u>SP3406</u>	VOLKSWAGEN	16 - 0n	Type VI T6 Caravelle, California, Kombi, Transporter van, Crew bus & Van (30) 4Motion 4WD (30) elec susp	Front
SP3408	VOLKSWAGEN	Aug'04 - 15	Type V Caravelle, Kombi, Crew bus, Transporter LCV & Van T5 (30) 4Motion 4WD (front engine) (30) front struts with bottom camber brackets	Rear
SP3422	AUDI	May'03-12	A3 2.0 Tdi (30) Quattro, Sport Susp & S3) OE Strut leg bottom outer diam = 50mm & 55mm	Front
SP3423	AUDI	May'03-12	A3 2.0 Fsi (30) Quattro, Sport Susp & S3) OE Strut leg bottom outer diam = 50mm & 55mm	Front
SP3424	AUDI	May'03-12	A3 2.0 Tdi 103kw-125kw heavy duty (30) Quattro, Sport Susp & S3) OE Strut leg bottom outer diam = 50mm & 55mm	Front
SP3425	AUDI	May'03-12	A3 2.0 Fsi all (30) Sportback (30) Quattro, Sport Susp & S3)	Rear
SP3427	AUDI	May'03-12	A3 2.0 Tdi all (30) Sportback (30) Quattro, Sport Susp & S3)	Rear
SP3430	BMW	March'05-12	3 series (E90 & E91) 318, 320, 323 (30) Sport susp, M3, Cabrio & Coupe)	Front
SP3431	BMW	End 04-Oct'11	1 Series 116i, 118i, 120i, 130i & 120d (30) Sport Susp, xDrive & 135i Coupe)	Front
<i>SP3432 > SP3431</i>	BMW	March'05-12	3 series (E90 & E91) 325, 330 (30) Sport susp, M3, Cabrio & Coupe)	Front
SP3434	BMW	End 04-Oct'11	1 Series 116i, 118i, 120i, 130i & 120d (30) Sport Susp, xDrive & 135i Coupe)	Rear
SP3446	MERCEDES-BENZ	Aug'02-09	W211 E200, E220, E270, E230, E240, E320 (30) S/Wagon, AMG & Elec & air susp)	Front
SP3451	MERCEDES-BENZ	Aug'02-09	W211 E200, E220, E230, E240 (30) S/Wagon, AMG & Elec & air susp)	Rear
SP3452	MERCEDES-BENZ	Aug'02-09	W211E270, E280, E300, E320, E350 (30) S/Wagon, AMG & Elec & air susp)	Rear
SP3460	CITROEN	05-Oct'10	C4 (Gen 1) 1.6i, 2.0i, 2.0HDI (30) Coupe (30) DS4 & sport susp)	Rear
SP3460	CITROEN	Nov'10-16	C4 (Gen 2) 1.6i, 2.0, 2.0 HDi (30) DS4 & sport susp)	Rear
<i>SP3463 > SE3463</i>	MERCEDES-BENZ	04-Aug'10	Vito Minibus & Van 109CDi, 111CDi, 115CDi, 119, 120CDi, 122, 123, 126 (3.5) RWD (30) air susp (OE: 60 red & 61 blue) (W639 Gen 2)	Front
<i>SP3463 > SE3463</i>	MERCEDES-BENZ	Sept'10-Sept '15	Vito Van 113, 115, 116, 122 RWD (30) air susp (W639 Gen 2 facelift) (30) AWD (OE: 60 red & 61 blue)	Front
SP3479	BMW	March'05-12	3 series (E90 & E91) 320i, 320d, 323i, 325i, 330d, 330i & 335i (30) S/W, Sport susp, M3, Cabrio & Coupe)	Rear
<i>SP3482 ></i>	BMW	March'05-12	3 series S/Wagon (E90 & E91) 320i, 320d, 323i, 325i, 330d, 330i & 335i (30) Sport susp, M3, Cabrio & Coupe)	Rear
SP3483	HONDA	98 - 02	CR-V 4x4 2.0 Gen 1 (RD1 - RD3)	Front
SP3484	HONDA	98 - 02	CR-V 4x4 2.0 Gen 1 (RD1 - RD3)	Rear
SP3488	VOLVO	June'99-April'00	S40 Sedan (30) Sport & T4)	Rear
SP3488	VOLVO	April'00-May'04	S40 Sedan (30) Sport & T4)	Rear
SP3489	VOLVO	June'99-April'00	V40 S/W (30) Sport & T4)	Rear
SP3489	VOLVO	April'00-May'04	V40 S/W (30) Sport & T4)	Rear
SP3490	VOLVO	June'99-April'00	S40 Sedan & V40 S/W (30) Sport & T4)	Front
SP3490	VOLVO	April'00-May'04	S40 Sedan & V40 S/W (30) Sport & T4)	Front
SP3491	FORD	Nov'04-July'11	Focus 1.6, 1.6Si, 1.8TDCi, 2.0, 2.0Si, 2.0TDCi & TDCi Si, (30) 2.5 ST front only, Hatch and Sedan MkII DA, DP (30) 2.5 ST rear & RS)	Rear
SP3493	FORD	Nov'04-July'11	Focus 1.6, 1.6Si, Hatch and Sedan MkII DA, DP (30) 2.5 ST rear & RS)	Front
SP3494	FORD	Nov'04-July'11	Focus 2.0 manual Hatch and Sedan MkII DA, DP	Front
SP3495	FORD	Nov'04-July'11	Focus 2.0 auto, 1.8TDCi, 2.0TDCi Hatch and Sedan MkII DA, DP	Front
SP3505	TOYOTA	Nov'02-Sept'07	Corolla Sedan & RunX Hatch 1.4 & 1.6 (30) Verso MPV, TRD) gen 9 (E120 & E121)	Front
SP3506	TOYOTA	Nov'02-Sept'07	Corolla Sedan & RunX Hatch (30) Verso MPV, TRD) gen 9 (E120 & E121)	Front
SP3508	TOYOTA	Nov'02-Sept'07	  Corolla Sedan & RunX Hatch (30) Verso MPV, TRD) gen 9 (E120 & E121)	Rear
SP3528	TOYOTA	01- Feb'06	RAV4 (ACA20,21 / ZCA 25, 26 / XA20) gen 2	Rear
SP3530	TOYOTA	01- Feb'06	RAV4 (ACA20,21 / ZCA 25, 26 / XA20) gen 2	Front

Key







*	See important installation information on inside front cover
!	Excluding self-levelling suspension
...	Special order - phone 010 900 1850. 6-12 week waiting period

~	Imported
#	Internal bump stop
⊕	Steering damper

- It is recommended that all new shock absorbers are fitted in pairs
- Do not mix gas and non-gas units on the same axle
- **Bold** part numbers indicate heavy-duty shocks
- Underlined part numbers indicate parts not immediately available
- *Italic* part numbers followed by > indicate parts to be discontinued

Springs

Part number [numerical listing]

Part number	Make	Year	Application	Position
SP3532	HYUNDAI	04 - 10	Tucson All (JM) gen 1 (EXCL 4x2 & 2.0 petrol)	Front
SP3532	KIA	Oct'04-Sept'10	Sportage 4x4 (EXCL 4x2 & 2.0 petrol) Gen 2 (JE / KM)	Front
SP3533	HYUNDAI	04 - 10	Tucson All (JM) gen 1 (EXCL 4x2)	Rear
SP3533	KIA	Oct'04-Sept'10	Sportage 4x4 Gen 2 (JE / KM) (EXCL 4x2)	Rear
SP3554	HYUNDAI	03-11	Getz 1.1 & 1.3 (TB)	Front
SP3555	HYUNDAI	03-11	Getz (TB)	Rear
SP3556	HONDA	02-06	CR-V 4x4 2.0 Gen 2 (RD4 - RD8) (EXCL 2.2)	Front
SP3557	HONDA	02-06	CR-V 4x4 2.0, 2.2 Gen 2 (RD4 - RD8) (Models with Xenon headlights - Check for rear shock bracket)	Rear
SP3559	MAZDA	04-09	Mazda 3 gen 1 (BK) (EXCL 2.0CD, 2.3, MPS, sport susp or AWD)	Rear
SP3560	MAZDA	04-09	Mazda 3 gen 1 (BK) (EXCL 1.6Di turbo, 2.0, 2.0CD, 2.3, MPS sport susp or AWD)	Front
SP3578	MERCEDES-BENZ	05-12	A170 & A200 Manual (W169)	Front
SP3578	MERCEDES-BENZ	06-March'12	B170 & B200 manual (W245)	Front
SP3579	MERCEDES-BENZ	06-March'12	B170 & B200 auto (W245)	Front
SP3580	MERCEDES-BENZ	05-12	A180Cdi Auto (W169)	Front
SP3584	MERCEDES-BENZ	06-March'12	B200Cdi auto (W245)	Front
SP3617	BMW	04-10	X3 (E83) 2.5, 3.0 & 2.0 d (EXCL Sport susp (EXCL elec susp)	Front
SP3714	TOYOTA	05 - Sept'11	Yaris Hatch & (Vios) Sedan (NBC2) 1.0 & 1.3 gen 2 (XP90)	Front
SP3714	TOYOTA	Oct'11- 19	Yaris Hatch 1.0, 1.3 & Sedan (EXCL 1.5, 1.8 & 1.4D) gen 3 (XP130)	Front
SP3716	TOYOTA	05 - Sept'11	Yaris 1.0 1.3 Hatch & (Vios) Sedan (NBC2) gen 2 (XP90)	Rear
SP3716	TOYOTA	Oct'11- 19	Yaris Hatch 1.0, 1.3 & Sedan gen 3 (XP130) (EXCL 1.5, 1.8)	Rear
SP3717	TOYOTA	Oct '07-13	Corolla Sedan 1.4 gen 10 (E140, E150, E152)	Front
SP3718	TOYOTA	07-March'13	Auris 1.4, 1.6, 1.8 hatch (E150 / 330N) (EXCL TRD)	Front
SP3718	TOYOTA	Oct '07-13	Corolla Sedan 1.6 gen 10 (E140, E150, E152)	Front
SP3718	TOYOTA	14-19	Corolla QUEST 1.6 gen 10 (E140, E150)	Front
SP3720	TOYOTA	07-March'13	Auris 1.4, 1.6, 1.8, 2.0 hatch (E150 / 330N) (EXCL TRD)	Rear
SP3720	TOYOTA	Oct '07-13	 Corolla Sedan 1.4, 1.6, 1.8, 2.0D gen 10 (E140, E150, E152)	Rear
SP3720	TOYOTA	Feb 14-19	 Corolla Sedan 1.3, 1.4D, 1.6, 1.8 gen 11 "Profesional" (EXCL Quest (E170 / E180)	Rear
SP3720	TOYOTA	14-19	 Corolla QUEST 1.6 gen 10 (E140, E150)	Rear
SP3720	TOYOTA	Feb 19-on	 Corolla QUEST 1.8, gen 11 (E170/ E180)	Rear
SP3741	HYUNDAI	09-June'12	i30 Hatch (FD) gen 1 (EXCL diesel)	Front
SP3743	HYUNDAI	09-June'12	i30 Hatch (FD) gen 1	Rear
SP3787	FORD	Nov'08-Oct '12	Fiesta 1.4 Sedan & Hatch Mk 6 CB1, CCN (OE paint flash green+red, or violet+red)	Front
SP3788	FORD	Nov'08-Oct '12	 Fiesta Sedan & Hatch Mk 6 CB1, CCN (EXCL 1.6 ST)	Rear
SP3788	FORD	Nov 12-17	 Fiesta Sedan & Hatch Mk 6 facelift (EXCL ST)	Rear
SP3830	TOYOTA	March'06 -12	RAV4 (XA30) gen 3	Front
SP3832	TOYOTA	March'06 -12	RAV4 (XA30) gen 3	Rear
SP3900	FORD	Aug'11-15	Focus 1.6 Hatch and Sedan MkIII C346	Front
SP3902	FORD	Aug'11-18	Focus 1.0 & 1.5, Hatch and Sedan MkIII C346 (EXCL Tdci, 1.6, 2.0ST rear, RS, & facelift models)	Rear
SP3905	RENAULT	09-Aug 16	Megane III Hatch 1.2T, (EXCL GT, RS & Sport susp)	Front
SP3906	RENAULT	09-Aug 16	Megane III Hatch 1.4T, 1.6, (EXCL GT, RS & Sport susp)	Front
SP3921	VOLKSWAGEN	Feb'10-Jan '18	Polo Hatch 1.2TSi, (EXCL Vivo, Sedan & Cross (mk 5 model, 6R, 6C)	Front
SP3921	VOLKSWAGEN	March 18-on	Polo VIVO 1.2TSi (mk 5 model, 6R, 6C) (EXCL Maxx	Front
SP3922	VOLKSWAGEN	Feb'10-Jan '18	Polo Hatch 1.2TSi & 1.4TDi, (EXCL Vivo, Sedan & Cross (mk 5 model, 6R, 6C)	Rear
SP3922	VOLKSWAGEN	March 18-on	Polo VIVO 1.2TSi & 1.4TDi (mk 5 model, 6R, 6C) (EXCL Maxx	Rear
SP3934	HYUNDAI	10-March '16	iX35 4x2 (LM) gen 2	Rear
SP3934	KIA	Sept'10-March '16	Sportage 4x2 2.0, 2.4 Gen 3 (SL)	Rear
SP3935	HYUNDAI	10-March '16	iX35 4x4 (LM) gen 2	Rear
SP3935	KIA	Sept'10-March '16	Sportage 4x4 2.0, 2.4 Gen 3 (SL)	Rear
SP3936	HYUNDAI	10-March '16	iX35 4x2 (LM) gen 2 (EXCL CRDi)	Front
SP3936	KIA	Sept'10-March '16	Sportage 4x2 (EXCL CRDi) Gen 3 (SL)	Front
SP3937	HYUNDAI	10-March '16	iX35 4x2 (LM) gen 2 (CRDi only)	Front
SP3937	HYUNDAI	10-March '16	iX35 4x4 (LM) gen 2	Front
SP3937	KIA	Sept'10-March '16	Sportage 4x2 (CRDi only) & 4X4 Gen 3 (SL)	Front
SP3939	RENAULT	13-Sept '18	Duster 4x4 1.6, 1.5dci (EXCL Auto) gen 1 (HS)	Rear
SP3940	RENAULT	13-Sept '18	Duster 4x4 1.6, 1.5dci (EXCL Auto) gen 1 (HS)	Front

Key

*	See important installation information on inside front cover
!	Excluding self-levelling suspension
"..."	Special order - phone 010 900 1850. 6-12 week waiting period

~	Imported
#	Internal bump stop
⊕	Steering damper

- It is recommended that all new shock absorbers are fitted in pairs
- Do not mix gas and non-gas units on the same axle
- **Bold** part numbers indicate heavy-duty shocks
- Underlined part numbers indicate parts not immediately available
- *Italic* part numbers followed by > indicate parts to be discontinued

Springs

Part number [numerical listing]

Part number	Make	Year	Application	Position
SP3941	HYUNDAI	09-'15	i20 Hatch (PB) gen 1 EXCI facelift (petrol only)	Front
SP3943	HYUNDAI	08-18	i10 Hatch gen 1 (PA) EXCI diesel	Front
SP3944	AUDI	08 - 17	Q5 4x4 Quattro EXCI sport susp) Typ 8R	Front
SP3945	AUDI	08 - 17	Q5 4x4 Quattro EXCI sport susp) Typ 8R	Rear
SP3957 >	CITROEN	Dec'09-16	C3 II 1.4 & 1.6 VTI 120 EXCI 1.4 HDi Auto EXCI DS3 & Sport) (SC) 46mm & 51mm OD strut base	Front
SP3958 >	CITROEN	Dec'09-16	C3 II 1.4 HDi Auto & 1.6 HDi EXCI 1.6 VTI 120 EXCI DS3 & Sport) (SC) 46mm & 51mm OD strut base	Front
SP3959 >	CITROEN	Dec'09-16	C3 II EXCI DS3 & Sport) (SC) 46mm OD strut base	Rear
SP3959 >	CITROEN	Dec'09-16	C3 II EXCI DS3 & Sport) (SC) 51mm OD strut base	Rear
SP3960	HYUNDAI	08-18	i10 Hatch gen 1 (PA)	Rear
SP3961	HYUNDAI	09-'12	i20 Hatch (PB) gen 1	Rear
SP3961	HYUNDAI	13-Jan'15	i20 Hatch (PB) gen 1 – facelift	Rear
SP3981	HONDA	08-Jan'15	Jazz 1.4 Dsi & 1.5 Vtec gen 2 (GE)	Front
SP3982	HONDA	08-Jan'15	Jazz 1.4 Dsi & 1.5 Vtec gen 2 (GE)	Rear
SP3983	AUDI	11-May 18	A1 Gen 1 (Manual) (8X) EXCI Sport susp (122 PS)	Front
SP3984	AUDI	11-May 18	A1 Gen 1 (8X) EXCI Sport susp (122 PS)	Rear
SP4007	BMW	11-17	X3 (F25) 2.0i, 2.8i, & 2.0d, 30d EXCI 3.0 & 3.5 above 150kw, EXCI Sport susp sDrive & xDrive AWD EXCI elec susp)	Front
SP4008	BMW	11-17	X3 (F25) 2.0i, 2.8i, 3.0i, 3.5i & 2.0d, 30d EXCI Sport susp sDrive & xDrive AWD EXCI elec susp)	Rear
SP4013	CHEVROLET	Aug'10-17	Spark (M300) EXCI Lite	Front
SP4014	CHEVROLET	Aug'10-17	Spark (M300) EXCI Lite	Rear
SP4036 (July '11- April '13) SP4037 May '13 – June '17)	KIA	July'11-June '17	Picanto 1.0, 1.2 Hatch (TA) gen 2	Front
SP4038	KIA	July'11-June '17	Picanto 1.0, 1.2 Hatch (TA) gen 2	Rear
SP4039	KIA	Nov'11-May 17	Rio 1.2, gen 3 (UB)	Front
SP4040	KIA	Nov'11-May 17	Rio 1.4 EXCI diesel gen 3 (UB)	Front
SP4041	KIA	Nov'11-May 17	Rio 1.2, 1.4, 1.6 gen 3 (UB)	Rear
SP4063	CHEVROLET	11-18	Sonic sedan & hatch 1.4 (T300) EXCI RS 1.6 & 1.4 Turbo	Front
SP4065	CHEVROLET	11-18	Sonic sedan & hatch 1.6 (T300) EXCI RS 1.4 & 1.4 Turbo	Front
SP4066	CHEVROLET	11-18	Sonic sedan 1.4 & 1.6 (T300) EXCI RS 1.4 Turbo	Rear
SP4067	CHEVROLET	11-18	Sonic hatch 1.4 & 1.6 (T300) EXCI RS 1.4 Turbo	Rear
SP4126	VOLKSWAGEN	13-19	Golf VII 1.4 TSi, 2.0 TDi (EXCI Gti, V5, R, AWD & Sport susp) (5G) EXCI elec susp) OE Strut leg outer diam = 50mm	Rear
SP4134	VOLKSWAGEN	13-19	Golf VII 1.0, 1.2, 1.4 TSi (EXCI Gti, V5, R, AWD & Sport susp) (5G) EXCI elec susp)	Front
SP4135	VOLKSWAGEN	13-19	Golf VII 1.5, 1.6, 2.0 Tdi (EXCI Gti, V5, R, AWD & Sport susp) (5G) EXCI elec susp)	Front
SP4138	VOLKSWAGEN	13-19	Golf VII 1.0, 1.2 Tsi (EXCI Gti, V5, R, AWD & Sport susp) (5G) EXCI elec susp) OE Strut leg outer diam = 50mm	Rear
SP4227	FORD	Nov 12-17	Fiesta 1,0 manual Sedan & Hatch Mk 6 facelift EXCI ST)	Front
SP4228	FORD	Nov 12-17	Fiesta 1,0 auto, 1.5, 1.6 Sedan & Hatch Mk 6 facelift EXCI ST)	Front
SP4232	TOYOTA	April'13-19	Auris 1,3 & 1,8 (E180)	Front
SP4239	TOYOTA	June'05-Jan 16	HiLux / Vigo "D4D" 4x4 & Raised body 4x2, gen 7 (AN10, AN20, AN30) Standard height	Front
SP4252	HYUNDAI	April 16-22	Tucson All (TL) gen 3 4x2 (EXCI 2,0 Diesel CRDi)	Front
SP4253	HYUNDAI	April 16-22	Tucson All (TL) gen 3 4x2 2,0 Diesel CRDi	Front
SP4254	HYUNDAI	April 16-22	Tucson All (TL) gen 3 4x4 Petrol	Front
SP4255	HYUNDAI	April 16-22	Tucson All (TL) gen 3 4x4 2,0 Diesel CRDi	Front
SP4256	HYUNDAI	April 16-22	Tucson 4x2 (TL) gen 3	Rear
SP4257	HYUNDAI	April 16-22	Tucson 4x4 (TL) gen 3	Rear
SP4268*	VOLKSWAGEN	June 15-Oct '21	Caddy 2.0 All gen 3, EXCI Alltrack (2K Facelift)	Front
SP4295	FORD	end 11-19	Ranger 4x4 & 4x2 Hi-Trail raised body T6 (EXCI Raptor)	Front

Key







*	See important installation information on inside front cover
!	Excluding self-leveling suspension
“...”	Special order – phone 010 900 1850. 6-12 week waiting period

~	Imported
#	Internal bump stop
⊕	Steering damper

- It is recommended that all new shock absorbers are fitted in pairs
- Do not mix gas and non-gas units on the same axle
- **Bold** part numbers indicate heavy-duty shocks
- Underlined part numbers indicate parts not immediately available
- *Italic* part numbers followed by > indicate parts to be discontinued

Springs

Part number [numerical listing]

Part number	Make	Year	Application	Position
SPECIAL ORDER				
"RS40004"	FORD	end 11-19	Ranger 4x4 & 4x2 Hi-Trail raised body T6 [30] Raptor Coil Raised (30mm lift)	Front
"RS40026"	TOYOTA	90-98	Landcruiser 80 series S/Wagon [10] certain solid axle 105 series '98-'07 models) Raised +-50mm	Front
"RS40027"	TOYOTA	90-98	Landcruiser 80 series S/Wagon [10] certain solid axle 105 series '98-'07 models) Raised +-50mm	Rear
"RS40037"	TOYOTA	99-on	Landcruiser HZJ79 series LDV Rear leaf springs, Coil front Raised +-50mm	Front
"RS40041"	FORD	end 11-22	Ranger 4x4 & 4x2 Hi-Trail raised body T6, U bolts for leaf springs [30] Raptor) Raised 40mm	Rear
"RS40085"	FORD	mid 19-22	Ranger 4x4 & 4x2 Hi-Trail raised body T6 [30] Raptor) Coil Raised (40mm lift)	Front
"RS44024"	FORD	end 11-22	Ranger 4x4 & 4x2 Hi-Trail raised body T6 Leaf springs [30] Raptor) Raised 40mm	Rear
"RS44031"	TOYOTA	99-on	Landcruiser HZJ79 series LDV Rear leaf springs, Coil front Raised +-50mm	Rear
"SE0026"	MAZDA	97-99	121 Soho 1.2 & 1.3 gen 4 (BE, JA, JB)	Front
"SE0026"	MAZDA	99-06	121 Soho 1.2 & 1.3 gen 4 facelift (BE, JA, JB)	Front
"SE0509"	MAZDA	97-99	121 Soho gen 4 (BE, JA, JB)	Rear
"SE0509"	MAZDA	99-06	121 Soho gen 4 facelift (BE, JA, JB)	Rear
"SE2837"	OPEL	03-09	Meriva 1.7CDTi MPV (A)	Front
"SE2838"	OPEL	03-09	Meriva 1.4, 1.6, 1.8 MPV (A)	Front
"SE2863"	OPEL	Sept'04-09	Astra 1.8 [30] elec susp (model H)	Front
"SE3415"	OPEL	10-17	Meriva 1.4 mini MPV (B)	Front
"SE3439"	RENAULT	End 06-March'13	Clio 1.4, 1.5dCi & 1.6 [30] 1.2, 2.0 Sport, R27, 2.0 RS) For 1.2 see Clio II above	Front
"SE3440"	RENAULT	End 06-March'13	Clio 1.4, 1.5dCi & 1.6 [30] 1.2, 2.0 Sport, R27, 2.0 RS) For 1.2 see Clio II above	Rear
"SE3543"	RENAULT	99-13	Clio 1.2 [10] Va va voom [30] 1.2 16v, 1.4 & 1.6, 2.0 & 3.0 V6)	Front
"SE3545"	RENAULT	99-06	Clio 1.2 16v, 1.4, 1.5dCi & 1.6 [30] Sport 1.6, 2.0 & 3.0)	Front
"SE3547"	OPEL	Nov'07-Oct'15	Corsa Hatch [30] Lite, OPC and Sport) (D)	Rear
"SE3548"	OPEL	Nov'07-Oct'15	Corsa Hatch [30] Lite, OPC and Sport) (D)	Front
"SN0427"	OPEL	Nov'99-Sept'04	Astra hatch & Classic sedan 1.4 & 1.6 (G) [30] OPC & S/W)	Rear
"SN0430"	RENAULT	99-13	Clio 1.2 [10] Va va voom [30] 1.2 16v, 1.4 & 1.6, 2.0 & 3.0 V6)	Rear
"SN0430"	RENAULT	99-06	Clio 1.2 16v, 1.4, 1.5dCi & 1.6 [30] Sport 1.6, 2.0 & 3.0)	Rear
"SN2783"	RENAULT	03-14	Trafic 1.9 Dci panel van gen 2 (X83)	Front
"SN3466"	OPEL	03-09	Meriva 1.4, 1.6, 1.7CDTi, 1.8 mini MPV (A)	Rear
"SN3987"	OPEL	end 10-May 16	Astra [30] OPC, GTC, Elec susp) (J)	Rear
"SP0005"	MERCEDES-BENZ	86-95	W124 [30] 200, 200E, 230E & 200D [30] Self leveling susp, S/W, Sportline & V124 limo (W124)	Front
"SP0021"	MERCEDES-BENZ	86-95	W124 [30] 260E, 280E, 300E, 250D, 300D [30] Self leveling susp, S/W, Sportline & V124 limo (W124)	Front
"SP0032"	HYUNDAI	94-May'97	 Accent I (X3)	Front
"SP0032"	HYUNDAI	June'97-June'00	 Accent I (X3) facelift (Larger rear springpan than earlier model)	Front
"SP0039"	FORD	95-99	Escort 1.6 & 1.8 [10] SW	Front
"SP0059"	MERCEDES-BENZ	77-86	W123 300D [30] S/W	Front
"SP0084"	MERCEDES-BENZ	77-86	W123 200, 230 [30] S/W	Front
"SP0139"	NISSAN	Sept '14-23	X-Trail All gen 3 (T32)	Front
"SP0150"	MERCEDES-BENZ	77-86	W123 250, 280E [30] S/W	Front
"SP0166"	BMW	91-99	320, 323, 325. [10] Cabrio. [30] M. Tech). (E36)	Front
"SP0166"	BMW	91-92	320, 323, 325 [30] M. Tech. (E36)	Front
"SP0166"	BMW	93-99	320, 323, 325 Cabriolet [30] M Tech) (E36)	Front
"SP0219"	CHEVROLET	03-09	Optra J200	Front
"SP0295"	MAZDA	94-99	Etude BH / Astina 1.5, 1.6 & 1.8 BA - J55 (RSA Mnf)	Front
"SP0324"	VOLVO	97- Feb'00	V70 S/Wagon Gen1 [30] Elec Four-C & Nivomat rears)	Rear
"SP0385"	CHEVROLET	03-05	Spark (M100, M150)	Front
"SP0405"	OPEL	93- Oct'99	  Kadett & Astra [30] S/W) (F)	Rear
"SP0422"	MERCEDES-BENZ	86-95	W124 [30] E420, E500 [10] all CE models C124 coupes, [30] Self leveling susp, S/W, Sportline & V124 limo (W124)	Rear
"SP0452"	MERCEDES-BENZ	77-86	W123 200, 230, 240D, 250, 280E, 300D [30] S/W	Rear
"SP0472"	MAZDA	94-99	Etude BH / Astina BA - J55 (RSA Mnf)	Rear
"SP0520"	FORD	95-99	Escort 1.6 & 1.8 [30] 1.3 & 1.4)	Rear
"SP0569"	HONDA	92-95	Ballade [30] 1.6 16v Vtec) Mk5 SR4, E6 & EH	Rear
"SP0582"	HYUNDAI	94-May'97	 Accent I (X3)	Rear
"SP0593"	TOYOTA	90-98	Landcruiser 80 series S/Wagon [10] certain solid axle 105 series '98-'07 models) All Standard Susp	Rear
"SP0667"	AUDI	96- Jan'99	 A4 Avant [30] Quattro, Sport) 8D, B5	Rear
"SP0667"	AUDI	Feb'99-Nov'00	 A4 Avant [30] Sport susp, sedan & Quattro) B5, 8D	Rear

Key	
*	See important installation information on inside front cover
!	Excluding self-leveling suspension
"..."	Special order - phone 010 900 1850. 6-12 week waiting period

~	Imported
#	Internal bump stop
⊕	Steering damper

- It is recommended that all new shock absorbers are fitted in pairs
- Do not mix gas and non-gas units on the same axle
- **Bold** part numbers indicate heavy-duty shocks
- Underlined part numbers indicate parts not immediately available
- *Italic* part numbers followed by > indicate parts to be discontinued

Springs

Part number [numerical listing]

Part number	Make	Year	Application	Position
SPECIAL ORDER				
"SP0711"	MERCEDES-BENZ	94 - Aug'01	S/Wagon, EXC Sport susp (W202)	Rear
"SP0723"	CHEVROLET	03-05	Spark (M100, M150)	Rear
"SP1434"	MERCEDES-BENZ	00-04	A160 (W168)	Front
"SP1436"	MERCEDES-BENZ	00-04	A170Cdi (W168)	Front
"SP1439"	MERCEDES-BENZ	95-July'02	W210 E270 Classic & Elegance, Std. Susp EXC S/W & Elec susp	Front
"SP1439"	MERCEDES-BENZ	96-July'02	T210 E320T Classic & Elegance S/Wagon, std susp	Front
"SP1440"	MERCEDES-BENZ	95-July'02	W210 E200 Classic & Elegance EXC S/W, Sport & Elec susp	Front
"SP1440"	MERCEDES-BENZ	95-July'02	W210 E230 Classic & Elegance Std. Susp EXC S/W & Elec susp	Front
"SP1451"	MERCEDES-BENZ	96-July'02	T210 S/Wagon E320T, std susp EXC self-levelling	Rear
"SP1621"	OPEL	93- Oct'99	Kadett & Astra 1.8 EXC S/W (F)	Front
"SP1621"	OPEL	93- Oct'99	Astra Estate S/Wagon 1.8 & 2.0 (F)	Front
"SP1726" >	RENAULT	96- June'98	Scenic 1.6 Automatic, 1.9dCi, 2.0 EXC RX4	Front
"SP1726" >	RENAULT	June'98-Feb'04	Scenic 1.6 Automatic, 1.9dCi, 2.0 EXC RX4	Front
"SP1953"	TOYOTA	99-05	Yaris / Vitz Hatch 1.0 & 1.3 EXC 1.5 T-Sport (Cross border – non RSA) gen 1 (XP10)	Rear
"SP2074"	VOLKSWAGEN	98-Sept'02	Polo Classic Sedan (mk 3 6N) EXC sport susp	Rear
"SP2082"	VOLKSWAGEN	99-04 (Jetta till 2/06)	Golf IV & Jetta IV Tdi, 2.0, 2.3 (20mm & 22mm rod)	Front
"SP2099"	SUZUKI	98-Sept 18	Jimny SN413 (Rear Coil spring susp) JA33, JB33	Front
"SP2100"	SUZUKI	98-Sept 18	Jimny SN413 (Rear Coil spring susp) JA33, JB33	Rear
"SP2503"	HYUNDAI	01-06	Santa Fe 4x2 & 4x4 Gen 1 (SM)	Rear
"SP2538"	HYUNDAI	01-06	Santa Fe 4x2 & 4x4 Gen 1 (SM)	Front
"SP2784"	RENAULT	03 - 14	Trafic 1.9 Dci panel van gen 2 (X83) LWB 3.5m	Rear
"SP2787"	RENAULT	03 - 14	Trafic 1.9 Dci panel van gen 2 (X83) SWB 3.0m	Rear
"SP2825"	OPEL	98-12	Movano Van Mk1 EXC pick-up rear (X70)	Front
"SP2895"	RENAULT	March'04-end 09	Scenic II 1.9dCi, 2.0	Front
"SP2895"	RENAULT	Sept'04-end 09	Grand Scenic II (LWB) 1.9dCi, 2.0	Front
"SP2896"	RENAULT	March'04-end 09	Scenic II 1.6	Front
"SP2898"	RENAULT	Sept'04-end 09	Grand Scenic II (LWB) 1.9dCi, 2.0	Rear
"SP2899"	RENAULT	March'04-end 09	Scenic II 1.6, 1.9dCi, 2.0	Rear
"SP2940"	LAND ROVER	01-March'07	Freelander All EXC 2.5 V6 (L314)	Front
"SP2963"	LAND ROVER	98-'01	Freelander 1.8 (L314)	Front
"SP2967"	LAND ROVER	98-'07	Freelander 3 door (L314)	Rear
"SP3090"	RENAULT	09-Aug 16	Megane III Hatch 1.2T, 1.4T, 1.6, 1.9dCi EXC 2.0T GT, RS & Sport susp	Rear
"SP3107"	TOYOTA	99-05	Yaris / Vitz Hatch 1.0 & 1.3 (Cross border – non RSA) gen 1 (XP10)	Front
"SP3112"	TOYOTA	95-00	RAV4 (3 door) Type SXA 10 & 11 EXC 235/60R 16" wheels gen 1	Front
"SP3257"	FORD	95- 99	Escort 1.3 & 1.4 EXC SW	Front
"SP3275"	LAND ROVER	98-'01	Freelander 2.0Tdi (L314)	Front
"SP3276"	LAND ROVER	98-'07	Freelander 5 door (L314)	Rear
"SP3281"	VOLKSWAGEN	99-04 (Jetta till 2/06)	Golf IV & Jetta IV Gti 20mm & 22mm rod	Front
"SP3294"	VOLKSWAGEN	04-Feb'09	Golf V Gti & R32 EXC 4-motion AWD	Rear
"SP3295"	VOLKSWAGEN	March'06-Sept'11	Jetta V 1.9 & 2.0 EXC V5 & Sport susp) 1K2 (A5). Strut leg bottom outer diam = 50mm	Rear
"SP3316"	MERCEDES-BENZ	Sept'00-April'07	W203 S/Wagon C180, C180K, C200, C200K, C220Cdi, C230, C230K, C240, C280, C320Cdi, C350 & C270CDI (W203) (C203) EXC AMG, Coupe & Sports susp)	Rear
"SP3316"	MERCEDES-BENZ	00-11	C180K, C200K, C230K and CLC200K, CLC350 (CLC203) EXC Sport susp & AMG	Rear
"SP3318"	MERCEDES-BENZ	00-11	C180K, C200K, C230K and CLC200K, CLC350 (CLC203) EXC Sport susp & AMG	Front
"SP3456"	CITROEN	08-14	C1 1.0 Gen 1 (PM)	Front
"SP3457"	CITROEN	08-14	C1 1.4 Hdi Gen 1 (PM)	Front
"SP3458"	CITROEN	08-14	C1 1.0 & 1.4 Hdi Gen 1 (PM)	Rear
"SP3497"	CHEVROLET	03-09	Opra J200	Rear
"SP3503"	NISSAN	04-10	Micra (K12E) gen3 EXC 1.5 & 1.6	Front
"SP3503"	NISSAN	04-10	Micra (K12E) gen3 EXC 1.5 & 1.6	Rear
"SP3552" EXC diesel	KIA	04-June'11	Picanto 1.0, 1.1 Hatch (SA / BA) gen 1	Front
"SP3553"	KIA	04-June'11	Picanto 1.0, 1.1 EXC diesel Hatch (SA / BA) gen 1	Rear
"SP3564"	VOLVO	07-13	C30 Hatch 1.8 & 2.0	Front

Key



- * See important installation information on inside front cover
- ! Excluding self-levelling suspension
- "..." Special order – phone 010 900 1850. 6-12 week waiting period

- ~ Imported
- # Internal bump stop
- ⊕ Steering damper

- It is recommended that all new shock absorbers are fitted in pairs
- Do not mix gas and non-gas units on the same axle
- **Bold** part numbers indicate heavy-duty shocks
- Underlined part numbers indicate parts not immediately available
- *Italic* part numbers followed by > indicate parts to be discontinued

Springs

Part number [numerical listing]

Part number	Make	Year	Application	Position
SPECIAL ORDER				
"SP3591"	BMW	Nov'03-May'10	All E60 5 Series Petrol sedan (EXC) 540i, 545i & 550i, Touring S/W, M5 & Sport susp)	Front
"SP3593"	BMW	Nov'03-May'10	All E60 5 Series Diesel sedan (EXC) 540i, 545i & 550i (EXC) Touring S/W, M5 & Sport susp)	Front
"SP3596"	BMW	Nov'03-May'10	All E60 5 Series sedan (EXC) Touring S/W, M5 & Sport susp)	Rear
"SP3607"	TOYOTA	04-Oct'09	Corolla Verso MPV (AR10)	Rear
"SP3621"	BMW	01-06	X5 (E53) 3.0i, 3.0d, 4.4iV8, 4.8 V8 4x4, (EXC) rear air susp (EXC) elec or self leveling susp & (EXC) front air susp)	Front
"SP3622"	BMW	01-06	X5 (E53) 3.0i, 3.0d, 4.4iV8, 4.8 V8 4x4, (EXC) rear air susp (EXC) elec or self leveling susp & (EXC) front air susp)	Rear
"SP3653"	CHEVROLET	05-July'10	Spark (M200, M250) (EXC) Lite 2010-on	Front
"SP3653"	CHEVROLET	Aug'10-17	Spark LITE (M200, M250)	Front
"SP3654"	CHEVROLET	05-July'10	Spark (M200, M250) (EXC) Lite 2010-on	Rear
"SP3654"	CHEVROLET	Aug'10-17	Spark LITE (M200, M250)	Rear
"SP3659"	HONDA	06-Aug'16	Civic 1.8 Hatch Mk8 + Mk9 (FN, FK) (EXC) 2.0, Type R & Tourer S/W	Rear
"SP3665"	NISSAN	02-March'08	X-Trail All gen1 (T30)	Rear
"SP3666"	NISSAN	02-March'08	X-Trail All gen1 (T30)	Front
"SP3673"	HYUNDAI	00-08	Atos & Atos Prime 1.1 (FF/MX)	Front
"SP3674"	HYUNDAI	00-08	Atos & Atos Prime 1.1 (FF/MX)	Rear
"SP3684"	HYUNDAI	06-July'11	Accent III (MC) (EXC) Diesel)	Front
"SP3686"	HYUNDAI	06-July'11	  Accent III (MC)	Rear
"SP3697"	NISSAN	07-09	Qashqai SUV All (J10)	Front
"SP3698"	NISSAN	10-June'14	Qashqai SUV (EXC) all +2, 1.5dci, 1.6, 2.0 (J10 facelift)	Front
"SP3699"	NISSAN	10-June'14	Qashqai SUV 2.0 dci (J10 facelift, (EXC) +2)	Front
"SP3700"	NISSAN	07-09	Qashqai SUV All (J10)	Rear
"SP3700"	NISSAN	10-June'14	Qashqai SUV (EXC) +2, (J10 facelift)	Rear
"SP3719"	TOYOTA	07-March'13	Auris 2.0 hatch (E150 / 330N) (EXC) TRD	Front
"SP3719"	TOYOTA	Oct '07-13	Corolla Sedan 2.0D gen 10 (E140, E150, E152)	Front
"SP3732"	HONDA	06-Aug'16	 Civic 1.8 Hatch Mk8 + Mk9 (FN, FK) (EXC) Type R & Tourer S/W	Front
"SP3789"	MAZDA	07-Feb'15	Mazda 2 1.3 & 1.5 (EXC) Auto (DE)	Front
"SP3790"	MAZDA	07-Feb'15	Mazda 2 1.4 & 1.6 (EXC) all Auto (DE)	Front
"SP3791"	MAZDA	07-Feb'15	Mazda 2 (DE)	Rear
"SP3807"	MITSUBISHI	99-April'07	Pajero 4x4 3.2 & 3.5 gen3 K94W, K96W, V64W, V65W, V68W, V74W, V75W & V78W (NM, NP) (EXC) elec susp) Check OE #'s	Front
"SP3809"	MITSUBISHI	99-April'07	MITSUBISHI	Rear
"SP3810"	CHEVROLET	07-18	Captiva 2.4 SUV 4x2 & 4x4 Gen 1 (EXC) facelift (C100) (EXC) Elec or air susp, or self leveling rear ie on Diesel	Front
"SP3811"	CHEVROLET	07-18	Captiva 2.0d, 3.0, 3.2 SUV 4x2 & 4x4 Gen 1 (EXC) facelift (C100) (EXC) Elec or air susp, or self leveling rear ie on Diesel	Front
"SP3812"	CHEVROLET	07-18	Captiva SUV 4x2 & 4x4 Gen 1 (EXC) facelift (C100) (EXC) Elec or air susp, or self leveling rear ie on Diesel	Rear
"SP3833"	FORD	Nov'08-Oct '12	Fiesta 1.4 Sedan & Hatch Mk 6 CB1, CCN (OE paint flash green+orange)	Front
"SP3839"	MERCEDES-BENZ	5/07-May'14	C180, C200, C220Cdi, C230, C250, C250Cdi, C280, C300, C320Cdi, C350Cdi & C350 - 1xred + 1xyellow (EXC) elec susp, Self level susp, AMG, Coupe, 4-Matic & Sports susp)	Front
"SP3839"	MERCEDES-BENZ	5/07-May'14	C180, C200, C220Cdi, C230, C250, C250Cdi, C280, C300, C320Cdi, C350Cdi & C350 2xred (EXC) elec susp, Self level susp, AMG, Coupe, 4-Matic & Sports susp)	Front
"SP3840"	MERCEDES-BENZ	5/07-May'14	C180, C200, C220Cdi, C230, C250, C250Cdi, C280, C300, C320Cdi, C350Cdi & C350 2xyellow (EXC) elec susp, Self level susp, AMG, Coupe, 4-Matic & Sports susp)	Front
"SP3841"	MERCEDES-BENZ	5/07-May'14	C180, C200, C220Cdi, C230, C250, C250Cdi, C280, C300, C320Cdi, C350Cdi & C350 3xred (EXC) elec susp, Self level susp, AMG, Coupe, 4-Matic & Sports susp)	Front
"SP3842"	MERCEDES-BENZ	5/07-May'14	C180, C200, C220Cdi, C230, C250, C250Cdi, C280, C300, C320Cdi, C350Cdi & C350 3xyellow (EXC) elec susp, Self level susp, AMG, Coupe, 4-Matic & Sports susp)	Front
"SP3846"	MERCEDES-BENZ	5/07-May'14	C180, C200, C220Cdi, C230, C250, C250Cdi, C280, C300, C320Cdi, C350Cdi & C350 (EXC) elec susp, Self level susp, AMG, Coupe, 4-Matic & Sports susp) 1xviolet	Rear
"SP3847"	MERCEDES-BENZ	5/07-May'14	C180, C200, C220Cdi, C230, C250, C250Cdi, C280, C300, C320Cdi, C350Cdi & C350 (EXC) elec susp, Self level susp, AMG, Coupe, 4-Matic & Sports susp) 2xviolet	Rear
"SP3851"	HYUNDAI	07-09	Santa Fe 4x2 2.7 only Gen 2 (CM) (EXC) elec or self-levelling susp)	Front
"SP3851"	HYUNDAI	09-12	Santa Fe 4x2 2.7 only Gen 2 (CM) (EXC) elec or self-levelling susp)	Front
"SP3853"	HYUNDAI	07-12	Santa Fe 4x2 Gen 2 (CM) (EXC) 2.0 & 2.4, elec or self-levelling susp)	Rear
"SP3854"	HYUNDAI	07-12	Santa Fe 4x4 Gen 2 (CM) (EXC) 2.0 & 2.4, elec or self-levelling susp)	Rear
"SP3894"	VOLVO	07-13	C30 Hatch 1.6, 1.8, 2.0, 2.4	Rear
"SP3908"	RENAULT	09-Aug 16	Megane III Hatch 1.9dCi (ExclGT, RS & Sport susp)	Front
"SP3923"	AUDI	08-Jan 16	A4 1.8 TFSi & 2.0 TFSi Sedan & Avant (EXC) Sport susp, Quattro, Elec susp & S4) B8	Front
"SP3924"	AUDI	08-Jan 16	A4 2.0 Tdi Sedan & Avant (EXC) Sport susp, Quattro, Elec susp & S4) B8	Front

Key





*	See important installation information on inside front cover
!	Excluding self-levelling suspension
"..."	Special order - phone 010 900 1850. 6-12 week waiting period

~	Imported
#	Internal bump stop
⊕	Steering damper

- It is recommended that all new shock absorbers are fitted in pairs
- Do not mix gas and non-gas units on the same axle
- **Bold** part numbers indicate heavy-duty shocks
- Underlined part numbers indicate parts not immediately available
- *Italic* part numbers followed by > indicate parts to be discontinued

Springs

Part number [numerical listing]

Part number	Make	Year	Application	Position
SPECIAL ORDER				
"SP3925"	AUDI	08-Jan 16	A4 Sedan (Sport susp, Quattro, Elec susp & S4) B8	Rear
"SP3926"	AUDI	08-Jan 16	A4 Avant S/W (Sport susp, Quattro, Elec susp & S4) B8	Rear
"SP3942"	HYUNDAI	09-'15	i20 Hatch (PB) gen 1 facelift (Diesel CRDi only)	Front
"SP3949"	MERCEDES-BENZ	96-July02	T210 S/Wagon E320T, self-levelling susp	Rear
"SP3969"	NISSAN	10-June'14	Qashqai +2 SUV (J10 facelift)	Rear
"SP3981"	HONDA	11-14	Ballade gen 5 (GM2, GM3)	Front
"SP3982"	HONDA	11-14	Ballade gen 5 (GM2, GM3)	Rear
"SP3987"	CHEVROLET	09-18	Cruze J300 (gen one) & J400 (gen two) Sedan & Hatch Sport susp, OPC	Rear
"SP3988"	OPEL	10-17	Meriva 1.4 mini MPV (B)	Rear
"SP4001"	SUZUKI	11-18	Swift 1.2, 1.4 gen 2 (AZG, FZ, NZ, ZC72S, ZC82S) 1.6 Sport ZC32S & 4WD	Front
"SP4002"  "SP4003" 	NISSAN	11-June 18	Micra (K13) gen 4	Front
"SP4004"	RENAULT	end 09-16	Scenic III MPV 1.9dCi	Front
"SP4004"	RENAULT	end 09-16	Grand Scenic III (LWB) 1.9dCi	Front
"SP4005"	RENAULT	end 09-16	Scenic III MPV 1.6, 1.9dCi	Rear
"SP4006"	RENAULT	end 09-16	Grand Scenic III (LWB) 1.9dCi	Rear
"SP4009"	CHEVROLET	09-18	Cruze J300 gen one 1.7 & 2.0 Sedan & Hatch Sport susp, OPC	Front
"SP4010"	OPEL	end 10-May 16	Astra 1.3 Cdti & 2.0, OPC, GTC, Elec susp) (J)	Front
"SP4010"	CHEVROLET	09-18	Cruze J300 gen one 1.4 & 1.6 Sedan & Hatch Sport susp, OPC	Front
"SP4011"	NISSAN	11-June 18	Micra (K13) gen 4	Rear
"SP4015"	SUZUKI	11-18	Swift 1.2, 1.4 gen 2 (AZG, FZ, NZ, ZC72S, ZC82S) 1.6 Sport ZC32S & 4WD	Rear
"SP4017"  "SP4018" 	ALFA ROMEO	09-18	MiTo hatch 1.4, 1.4T, 1.6JTD (1.4T QV sport, 1.8T GTA & Elec susp)	Front
"SP4019"	ALFA ROMEO	09-18	MiTo hatch 1.4, 1.4T, 1.6JTD (1.4T QV sport, 1.8T GTA & Elec susp)	Rear
"SP4023"	NISSAN	11-19	Juke 1.5 & 1.6 FWD (F15)	Front
"SP4023"	NISSAN	11-19	Juke 1.5 & 1.6 AWD (F15)	Front
"SP4052"	CITROEN	11-18	DS3 1.4 & 1.6 VTi 120 manual (1.2 & 1.4 Hdi 70 with stop/start 46mm & 51mm OD strut base	Front
"SP4053"	CITROEN	11-18	DS3 1.4Hdi 70 with stop/start & 1.6 (1.2 & 1.6 VTi 120 manual) 46mm & 51mm OD strut base	Front
"SP4054"	CITROEN	11-18	DS3 1.2 & 1.6 46mm & 51mm OD strut base	Rear
"SP4068"	VOLVO	10-18	S60 Sedan T4 & T5, gen 2 elec susp	Front
"SP4094"	NISSAN	05 - 15	Pathfinder 4x4 SUV (R51)	Front
"SP4095"	NISSAN	05 - 15	Pathfinder 4x4 SUV (R51)	Rear
"SP4100"	LAND ROVER	April'07-15	Freelander II (L359)	Front
"SP4101"	LAND ROVER	April'07-15	Freelander II (L359)	Rear
"SP4105"	MERCEDES-BENZ	Mid 09-April '16	W212 E200, E250 (S/W, Coupe, Cabrio, AMG, sport susp, air susp, elec susp & AWD)	Front
"SP4106"	MERCEDES-BENZ	Mid 09-April '16	W212 E300, E350 (S/W, Coupe, Cabrio, AMG, sport susp, air susp, elec susp & AWD)	Front
"SP4107"	MERCEDES-BENZ	Mid 09-April '16	W212 E200, E250, E250CDi, E300, E350, E400, E500 (S/W, Coupe, Cabrio, AMG, sport susp, air susp, elec susp & AWD)	Rear
"SP4114"	VOLVO	10-18	S60 Sedan D4, gen 2 elec susp	Front
"SP4115"	VOLVO	10-18	S60 Sedan, gen 2 elec susp	Rear
"SP4125"	RENAULT	13-19	Captur 0.9T, 1.2T, 1.5dci crossover SUV gen 1 (J87, J5, H5)	Front
"SP4127"	RENAULT	April'13-19	Clio 1.2 Sport susp, RS)	Rear
"SP4130"	RENAULT	13-19	Captur 0.9T, 1.2T, 1.5dci crossover SUV gen 1 (J87, J5, H5)	Rear
"SP4136"	VOLKSWAGEN	13-19	Golf VII Gti V5, R, AWD & Sport susp) (5G) elec susp) OE Strut leg outer diam = 55mm	Front
"SP4137"	VOLKSWAGEN	13-19	Golf VII 1.6 TDi (Gti, V5, R, AWD & Sport susp) (5G) elec susp) OE Strut leg outer diam = 50mm	Rear
"SP4142"	MERCEDES-BENZ	12-Aug 18	A180, A200, A200d, A220d, A250 (W176) AMG & Sport susp	Rear
"SP4143"	MERCEDES-BENZ	April'12-18	B180, B200, B200d, B220d, B250 (W246)	Rear
"SP4147"	MERCEDES-BENZ	12-Aug 18	A180, A200, A200d, A220d, A250 - Auto (W176) AMG & Sport susp	Front
"SP4147"	MERCEDES-BENZ	April'12-18	B180, B200, B200d, B220d, B250 - Auto (W246)	Front
"SP4151"	MERCEDES-BENZ	12-Aug 18	A180, A200, A200d, A220d, A250 - Manual (W176) AMG & Sport susp	Front
"SP4151"	MERCEDES-BENZ	April'12-18	B180, B200, B200d, B220d, B250 - Manual (W246)	Front
"SP4164"	NISSAN	July'14-Sept 22	Qashqai SUV 1.5dci, 4x2 (J11)	Front
"SP4165"	NISSAN	July'14-Sept 22	Qashqai SUV 1.6dci 4x2 and 1.6dci 4x4 (J11)	Front
"SP4166"	NISSAN	July'14-Sept 22	Qashqai SUV 1.2T, 4x2 (J11)	Front
"SP4167"	NISSAN	July'14-Sept 22	Qashqai SUV 1.2T, 1.5dci, 1.6dci 4x2 (J11)	Rear
"SP4178"	NISSAN	July'14-Sept 22	Qashqai SUV 1.6dci 4x4 (J11)	Rear

Key

*	See important installation information on inside front cover
!	Excluding self-levelling suspension
"..."	Special order - phone 010 900 1850. 6-12 week waiting period

~	Imported
#	Internal bump stop
⊕	Steering damper

- It is recommended that all new shock absorbers are fitted in pairs
- Do not mix gas and non-gas units on the same axle
- **Bold** part numbers indicate heavy-duty shocks
- Underlined part numbers indicate parts not immediately available
- *Italic* part numbers followed by > indicate parts to be discontinued

Springs

Part number [numerical listing]

Part number	Make	Year	Application	Position
SPECIAL ORDER				
"SP4179"	OPEL	15-April 22	Mokka & Mokka X cross-over 1.4, 1.6 SUV FWD (304 AWD) [Facelift Aug '16] gen 1 (J13)	Front
"SP4180"	OPEL	15-April 22	Mokka & Mokka X cross-over 1.7CDTi SUV FWD (304 AWD) [Facelift Aug '16] gen 1 (J13)	Front
"SP4193"	OPEL	15-April 22	Mokka & Mokka X cross-over SUV FWD (304 AWD) [Facelift Aug '16] gen 1 (J13)	Rear
"SP4214"	BMW	10-Oct 15	X1 (E84) sDrive FWD	Front
"SP4215"	BMW	10-Oct 15	X1 (E84) xDrive AWD	Front
"SP4216"	BMW	10-Oct 15	X1 (E84) sDrive FWD	Rear
"SP4216"	BMW	10-Oct 15	X1 (E84) xDrive AWD	Rear
"SP4225"	OPEL	Nov'15-19	Corsa Hatch 1.0T, 1.4 (304) 1.4 Turbo Sport (E)	Front
"SP4226"	OPEL	Nov'15-19	Corsa Hatch 1.0T, 1.4 (304) 1.4 Turbo Sport (E)	Rear
"SP4234"	FORD	13-'19	Kuga1,5 & 2,0 4x2 & 4x4 SUV (gen 2) DM2, C520	Rear
"SP4237"	RENAULT	April'13-19	Clio 1.2 (304) Sport susp, RS)	Front
"SP4240"	VOLVO	09-Sept 18	XC60 2,4 AWD Cross Country SUV gen 1 (304) elec & self leveling susp	Rear
"SP4241"	MINI	14-24	Mini One 1.2 (F56 - 3 door, F55 - 5 door Mk III) (304) cabriolet (F57) & sport (304) JCW GP sport)	Front
"SP4242"	MINI	14-24	Mini One, 1.5, 2.0, Cooper (F56 - 3 door, F55 - 5 door Mk III) (304) cabriolet (F57) & sport (304) JCW GP sport)	Front
"SP4243"	MINI	14-24	Mini One, Cabrio (F57) (304) JCW GP sport)	Front
"SP4244"	MINI	14-24	Mini One, Cooper F56 - 3 door Mk III (304) F55 5 door, JCW GP sport)	Rear
"SP4245"	MINI	14-24	Mini One, Cooper F55 - 5 door Mk III (304) F56 - 3 door, Cooper Diesel, JCW GP sport)	Rear
"SP4247"	MINI	14-24	Mini One, Cooper F57 cabriolet (304) JCW GP sport)	Rear
"SP4248"	VOLKSWAGEN	Sept'15-19	Passat sedan 1,4 & 2,0 (304) AWD, Diesel & Hybrid) (304) elec susp) (B8)	Rear
"SP4249"	VOLKSWAGEN	Sept'15-19	Passat sedan 1,8 & 2,0D (304) AWD & Hybrid) (304) elec susp) (B8)	Rear
"SP4273" OR "SP4274" OR "SP4275"	FORD	13-22	Tourneo Custom 8 seater minibus & Transit Custom van (V36X, F3, FY, FZ) FWD Check OE & VIN#s for correct ordering numbers	Front
"SP4281"	MERCEDES-BENZ	June'14-June '21	W205 C class C180, C200, C250, C300 & C350e Petrol (304) S/Wagon, Elec susp, Self level susp, Coupe, 4-Matic, AMG & Sports susp)	Front
"SP4283"	MERCEDES-BENZ	June'14-June '21	W205 C class C220d, C250d, Diesel (304) S/Wagon, Elec susp, Self level susp, Coupe, 4-Matic, AMG & Sports susp)	Front
"SP4288"	MERCEDES-BENZ	June'14-June '21	W205 C class C180, C200, C220d, C250, C250d, C300 & C350e (304) S/Wagon, Elec susp, Self level susp, Coupe, 4-Matic, AMG & Sports susp)	Rear
"SP4294"	FORD	Nov'08-Oct '12	Fiesta 1.0 Sedan & Hatch Mk 6 CB1, CCN	Front
"SP4299"	TOYOTA	Oct'15-21	Aygo hatch gen 2 with panorama roof (AB40) (304) Agya models	Front
"SP4300"	TOYOTA	Oct'15-21	Aygo hatch gen 2 without panorama roof (AB40) (304) Agya models	Front
"SP4301"	TOYOTA	Oct'15-21	Aygo hatch gen 2 with panorama roof (AB40) (304) Agya models	Rear
"SP4302"	TOYOTA	Oct'15-21	Aygo hatch gen 2 without panorama roof (AB40) (304) Agya models	Rear
"SP4312"	VOLVO	12-19	V40 T3 & T4 Hatch (304) T series	Front
"SP4313"	VOLVO	12-19	V40 Hatch (304) T5	Front
"SP4314"	VOLVO	12-19	V40 Hatch (304) T series	Front
"SP4315"	VOLVO	12-19	V40 Hatch Std, T3, T4 & T5 (304) T series	Rear
"SP4316"	VOLVO	12-19	V40 Hatch D2 (304) T series	Rear
"SP4350"	VOLKSWAGEN	20-on	T-Roc SUV (304) electronic susp (A11)	Front
"SP4351"	VOLKSWAGEN	20-on	T-Roc SUV (304) electronic susp (A11)	Rear

Key

*	See important installation information on inside front cover
!	Excluding self-levelling suspension
"..."	Special order - phone 010 900 1850. 6-12 week waiting period

~	Imported
#	Internal bump stop
⊕	Steering damper

- It is recommended that all new shock absorbers are fitted in pairs
- Do not mix gas and non-gas units on the same axle
- **Bold** part numbers indicate heavy-duty shocks
- Underlined part numbers indicate parts not immediately available
- *Italic* part numbers followed by > indicate parts to be discontinued

Identification of shock absorber mountings and matching shock absorbers

1. How to measure shock absorbers

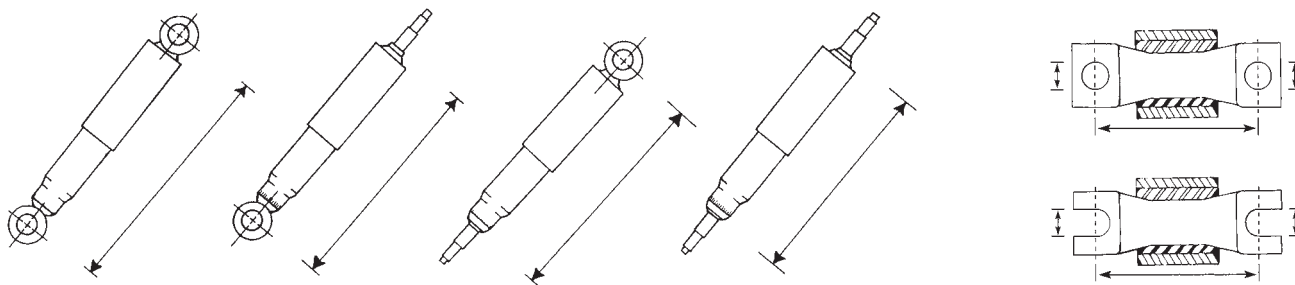

2. Mounting combinations

a. Eye combinations

All eye combinations are identified by the prefix "E" followed by one of the following:

E: Rubber fitted to eye with no metal sleeve, cross stem or bolt

S: Metal sleeve fitted in rubber

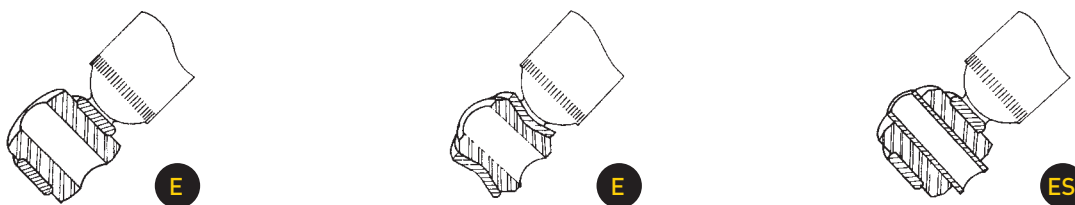

X: Cross stem fitted in rubber

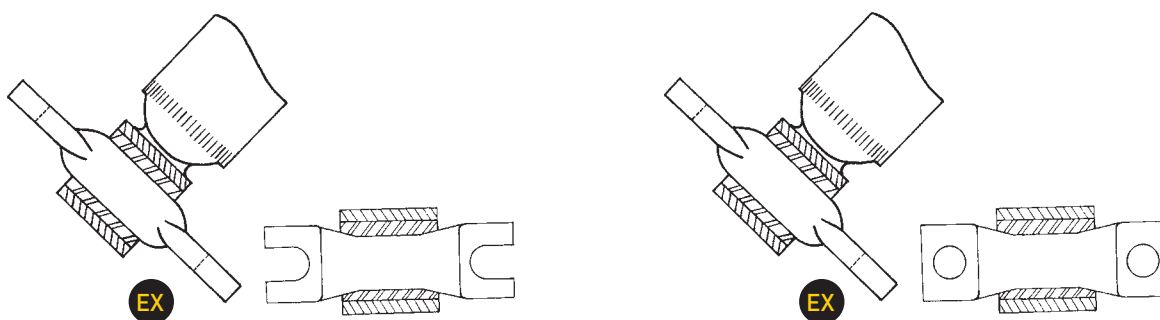

B: Bolt fitted in rubber

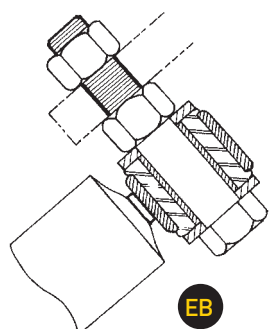

This code is followed by three digits which signifies our internal coding for the eye and the type of mounting combination.

Identification of shock absorber mountings and matching shock absorbers

b. Stud combinations

All stud combinations are identified by the prefix "S" followed by two digits signifying the nominal shank diameter, measured in millimetres.

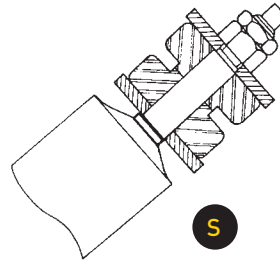
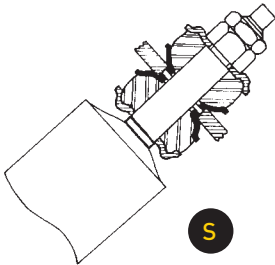

NB: All integral rods, i.e. where the stud form is machined directly on the rod, are classified as "SP" as these units are unique to each application and therefore cannot be matched.

Where the shock absorber is imported by us, no numerical coding exists and therefore, only the alphabetical code applies.

c. Special combinations

Any combination which is unique to an application has been classed as "SP" eg: Special pressings fitted to the Mercedes 108, 111, 114 and 115 front shock absorbers as well as the 116, 123 and 126 front shock absorbers.

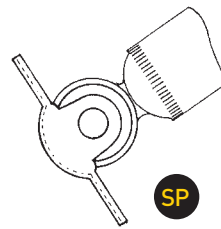
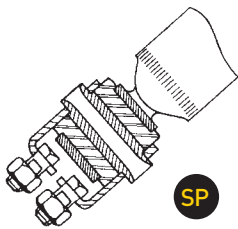

This also applies to the special plate fitted to the Peugeot 302 rear shock absorbers, and the stud plate fitted to the Ford Fairlane, Fairmont and Ranchero front shock absorbers.

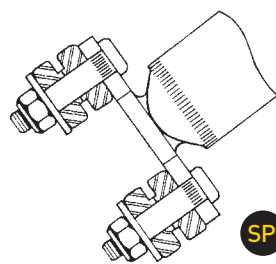
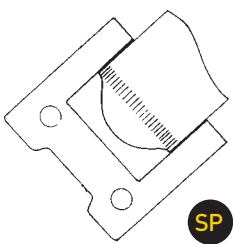

3. Matching of shock absorbers

Our warranty terms state that any units fitted to a vehicle for which they are not listed in our catalogue are not covered. Therefore the information given on open and closed lengths and mountings in the grouping section should only be used to match a unit as a last resort. This is due to the fact that whilst two units may be interchangeable from an installation point of view, the valve settings may be substantially different, resulting in poor ride and handling when fitted to a vehicle for which they have not been engineered.

Contact Tenneco Helpline on 010 900 1850

NOTE: Using a shock that is "matched up" invalidates the guarantee.

Monroe shock absorbers

Telescopic shocks – Grouping by closed length [numerical listing]

Part number	Mounting information	Top mounting	Bottom mounting	Open length (mm)	Closed length (mm)	Position
M8030	⊥ ⊕	⊥ 10 x 35	⊖ 12 x 32	297	201	Front
R3472	⊖ ⊖	⊖ 10	⊖ 10	338	208	Rear
V2065	⊥ ⊕	⊥	⊖ 14 x 50	288	211	Front
GT2021	⊥ ⊕	⊥ 10	⊖ 12	319	213	Front
GT1015	⊖ ⊖	⊖ 10	⊖ 10	324	216	Front
GT2025	⊥ ⊕	⊥ 10	⊖ 12	340	218	Front
M4462	⊥ ⊕	⊥ 10	⊖ 12	317	218	Front
V1063	⊥ ⊕	⊥	⊖ 8 x 45	341	218	Front
G1264	⊖ ⊖	⊖ 10	⊖ 12	318	222	Rear
M8046	⊥ ⊕	⊥ 10 x 55	⊖ 12 x 32	333	223	Front
25485 >	⊖ ⊖	⊖ 10,1 x 38	⊖ 12,1 x 35	323	224	Rear
V2077	⊖ T	⊖ 12 x 52	⊥	313	225	Rear
GT2028	⊥ ⊕	⊥ 10	⊖ 8,4 x 65	354	227	Front
GT2009	⊥ ⊕	⊥ 10 x 55	⊖ 12 x 32	349	228	Front
GT2010	⊥ ⊕	⊥ 10	⊖ 9	346	228	Front
<i>D8014 > D8014S</i>	⊥ ⊕	⊥	⊖ 12 x 32	341	229	Front
GT1014	⊥ ⊕	⊥ 10	⊖ 10	368	230	Rear
GT2035	⊥ ⊕	⊥ 10	⊖ 9	365	230	Front
M8047	⊥ ⊕	⊥ 10 x 55	⊖ 12 x 32	350	230	Front
M8060	⊥ ⊕	⊥ 10	⊖ 8	355	230	Front
GT2045	⊥ ⊕	⊥ 10	⊖ 16	348	231	Front
M8043	⊥ ⊕	⊥ 10 x 55	⊖ 9	353	232	Front
GT2023	⊥ ⊕	⊥ 10	⊖ 9	365	233	Front
M6432	⊥ ⊕	⊥ 10	⊖ 16	349	234	Front
M7299	⊥ ⊕	⊥	⊖ 12	343	235	Front
M8051	⊥ ⊕	⊥ 10 x 55	⊖ 12 x 32	313	235	Front
M8058	⊥ ⊕	⊥ 10	⊖ 12 x 32	372	235	Front

Key

*	See important installation information on inside front cover
!	Excluding self-levelling suspension
"..."	Special order – phone 010 900 1850. 6-12 week waiting period

~	Imported
#	Internal bump stop
⊕	Steering damper

- It is recommended that all new shock absorbers are fitted in pairs
- Do not mix gas and non-gas units on the same axle
- **Bold** part numbers indicate heavy-duty shocks
- Underlined part numbers indicate parts not immediately available
- *Italic* part numbers followed by > indicate parts to be discontinued

Monroe shock absorbers

Telescopic shocks – Grouping by closed length [numerical listing]

Part number	Mounting information	Top mounting	Bottom mounting	Open length (mm)	Closed length (mm)	Position
<i>D7704 > D7704S</i>	⊥ ⊕	⊥	⊖ 12 x 32	367	236	Front
GT2094	⊥ ⊕	⊥ 10	⊖ 12 x 32	371	236	Front
M5468	⊥ ⊕	⊥ 10	⊖ 11	362	236	Front
GT2030	⊥ ⊕	⊥ 10	⊖ 12 x 32	374	237	Front
M7366	⊥ ⊕	⊥ 10 x 50	⊖ 12 x 40	367	237	Front
42041	⊖ ⊖	⊖ 12	⊖ 14	314	238	Rear
GT2033	⊥ ⊕	⊥ 10	⊖	350	240	Front
GT2084	⊥ ⊕	⊥	⊖ 12,1 x 32	373	240	Front
M5464	⊥ ⊕	⊥ 10 x 55	⊖ 12 x 32	374	246	Front
RS999145	⊥ ⊕	⊥ 10	⊖ 16	338	247	Front
G1101A	⊥ ○	⊥	⊖ 12 x 40	552	250	Rear
G1111	○ ○	⊖ 12	⊖ 12	356	250	Rear
G1083	○ ○	⊖ 10	⊖ 12	371	251	Rear
5657ST	⊖ ⊖	⊖ 12	⊖ 12	375,666	254	Rear
GT1030	⊖ ⊖	⊖ 12	⊖ 15	386	254	Rear
GT2011	⊖ ⊖	⊖ 12	⊖ 12	387	255	Rear
GT2074	⊖ ⊖	⊖ 12	⊖ 12	387	255	Front
<i>D7029 > D7029S</i>	⊥ ○	⊥	○ 16	405	257	Front
G2223	○ ○	⊖ 12	⊖ 12	373	257	Rear
M8354	⊥ ⊕	⊥ 10 x 67	⊖ 12 x 32	394	257	Front
23977	⊖ ⊖	⊖ 11	⊖ 12	384	258	Rear
M8031	⊥ ⊕	⊥ 10	⊖ 12 x 32	378	258	Front
G2222	○ ○	⊖ 12 x 47	⊖ 12 x 40	374	260	Rear
23473	⊖ ⊖	⊖ 10	⊖ 12	394	262	Rear
43109	⊖ ⊖	⊖ 12	⊖ 14	357	262	Rear
D8068S	⊖ ⊖	⊖ 14 x 48	⊖ 14 x 48	371	262	Rear
G22709	○ ○	⊖ 12 x 36	⊖ 12 x 36	383	262	Rear

Key

*	See important installation information on inside front cover
!	Excluding self-levelling suspension
"..."	Special order – phone 010 900 1850. 6-12 week waiting period

~	Imported
#	Internal bump stop
⊕	Steering damper

- It is recommended that all new shock absorbers are fitted in pairs
- Do not mix gas and non-gas units on the same axle
- **Bold** part numbers indicate heavy-duty shocks
- Underlined part numbers indicate parts not immediately available
- *Italic* part numbers followed by > indicate parts to be discontinued

Monroe shock absorbers

Telescopic shocks – Grouping by closed length [numerical listing]

Part number	Mounting information	Top mounting	Bottom mounting	Open length (mm)	Closed length (mm)	Position
M8034	⊥ ⊕	⊥ 11	⊕ 13	410	262	Front
RS999039	⊥ ⊕	⊥ 10	○ 16	368,3	262,636	Front
RS999214	⊥ ⊕	⊥ 10	⊕ 12	368,3	262,636	Front
23869	⊥ ⊕	⊥	⊕ 12	398	264	Rear
R1643	⊕ ⊕	⊕ 12 x 32	⊕ 12 x 32	399	266	Rear
37290ST	⊕ ⊕	⊕ 12	⊕ 12	396,748	266,7	Rear
23964	⊕ ⊕	⊕ 12	⊕ 14	407	267	Rear
V5007	⊕ ⊕	⊕ 14 x 40	⊕ 14 x 40	384	267	Rear
V1034	⊕ ⊕	⊕ 12 x 40	⊕ 12 x 40	413	268	Front
23982	⊕ ⊕	⊕ 12	⊕ 14	417	272	Rear
43104	○ ○	⊕ 16	⊕ 16	377	272	Rear
43114	○ ○	○ 16	○ 16	367	272	Rear
G1061	⊕ ⊕	⊕ 12 x 47	⊕ 14 x 40	417	272	Rear
G1105	⊕ ⊕	⊕ 14 x 50	⊕ 14 x 45	397	272	Rear
AU160132	⊥ T	⊥ 10	⊥ 10	453	273	Front
M5454	⊥ ⊕	⊥ 11,7 x 51	⊕ 12 x 32	431	276	Front
<u>V1206</u>	⊕ ⊕	⊕ 16 x 64	⊕ 16 x 38	421	276	Rear
GT2082	⊕ ⊕	⊕ 12 x 48	⊕ 15 x 40	428	277	Rear
V2518	⊕ ⊕	⊕ 12 x 45	⊕ 14 x 45	407	278	Front
D7705S	⊥ ⊕	⊥	⊕ 12 x 32	398	279	Front
GT2107	⊥ ⊕	⊥ 12 x 67	⊕ 14 x 39	402	280,5	Front
V1055	⊕ ⊕	⊕ 16 x 38	⊕ 16 x 38	443	282	Front
V2130	⊕ ⊕	⊕ 16 x 40	⊕ 16 x 40	418	282	Rear
G55023	⊥ ⊕	⊥	⊕ 12 x 73,8	433	283	Rear
GT2020	⊕ ⊕	⊕ 10	⊕ 10	442	283	Rear
D8022 - D8022S	⊥ ⊕	⊥	⊕ 20 x 39	440	284	Front
M8036	○ ○	○ 19	○ 19	437	284	Front

Key

*	See important installation information on inside front cover
!	Excluding self-levelling suspension
"..."	Special order – phone 010 900 1850. 6-12 week waiting period

~	Imported
#	Internal bump stop
⊕	Steering damper

- It is recommended that all new shock absorbers are fitted in pairs
- Do not mix gas and non-gas units on the same axle
- **Bold** part numbers indicate heavy-duty shocks
- Underlined part numbers indicate parts not immediately available
- *Italic* part numbers followed by > indicate parts to be discontinued

Monroe shock absorbers

Telescopic shocks – Grouping by closed length [numerical listing]

Part number	Mounting information	Top mounting	Bottom mounting	Open length (mm)	Closed length (mm)	Position
376098SP	⊥ ⊕	⊥	⊖ 12	433	285	Rear
G1084	○ ○	○ 12	○ 12	445	285	Rear
G1118	○ ○	○ 14	○ 16	395	285	Rear
GT1021	⊖ ⊖	⊖ 10	⊖ 10	459	285	Rear
G1080	○ ○	○ 10	○ 10	369	287	Rear
GT1028	⊖ T	⊖ 10	⊥ 10	475	287	Rear
53005	⊥ ⊕	⊥ 11	⊖ 16	444	288	Rear
37289ST	⊖ ⊖	⊖ 12	⊖ 12	433	288	Rear
G2224	⊥ ⊕	⊥	⊖ 14 x 52	463	289	Rear (no dust cover)
D7644S	⊥ ⊕	⊥	⊖ 12 x 37	461	290	Rear
G2119	⊥ ○	⊥	⊖ 14	830	290	Rear
V2516	⊖ ⊖	⊖ 16 x 38	⊖ 16 x 38	446	291	Front
RS999136	⊥ ○	⊥ 10	○ 16	426,72	291,846	Front
R3469	○ ○	⊖ 12	⊖ 12	461	292	Rear
V2132	⊖ ⊖	⊖ 16 x 40	⊖ 16 x 40	443	292	Rear
D8483S	⊥ T	⊥	⊥	473	293	Front
M8039	○ ○	○ 16	○ 16	467	293	Front
G2122	⊖ ⊖	⊖ 16	⊖ 22	437	295	Rear
GT2096	○ ○	○ 16	○ 20	474	295	Rear
M8048	○ ○	○ 16	○ 20	462	295	Rear
65419MM	⊖ ⊖	⊖ 19	⊖ 19	432	295	Rear
AU160466	⊥ T	⊥ 14	⊥ 14	486	296	Front
<i>D4470 > D4470S</i>	⊥ T	⊥ 12	⊥ 12	471	296	Front
GT2006	○ ○	○ 16	○ 16	472	296	Rear
M7300	⊥ ⊕	⊥ 10 x 55	⊖ 16 x 38	457	296	Rear
23980	○ ○	⊖ 12	⊖ 12	448	298	Rear
37345ST	⊖ ⊖	⊖ 16	⊖ 16	457,962	298,958	Rear

Key

*	See important installation information on inside front cover
!	Excluding self-levelling suspension
"..."	Special order – phone 010 900 1850. 6-12 week waiting period

~	Imported
#	Internal bump stop
⊕	Steering damper

- It is recommended that all new shock absorbers are fitted in pairs
- Do not mix gas and non-gas units on the same axle
- **Bold** part numbers indicate heavy-duty shocks
- Underlined part numbers indicate parts not immediately available
- *Italic* part numbers followed by > indicate parts to be discontinued

Monroe shock absorbers

Telescopic shocks – Grouping by closed length [numerical listing]

Part number	Mounting information	Top mounting	Bottom mounting	Open length (mm)	Closed length (mm)	Position
42022	⊥ ○	⊥	○ 16	474	300	Rear
43027	⊥ ⊕	⊥	⊖ 11	466	301	Front
D7706S	⊖ ⊖	⊖ 12 x 32	⊖ 12 x 32	460	301	Rear
GT1013	⊥ ○	⊥ 12 x 59mm	⊖ 22 x 40mm	478	302	Rear
GT1026	⊥ ⊖	⊥ 10	⊖ 10	498	302	Rear
GT2001	⊖ ⊖	⊖ 10	⊖ 10	491	302	Rear
43112	○ ○	⊖ 10	⊖	346	303	Rear
V2079	⊖ ⊖	⊖ 13 x 32	⊖ 15 x 52	416	303	Front
<u>V2135</u>	⊖ ⊖	⊖ 16 x 38	⊖ 16 x 38	473	303	Rear
G1170	○ ○	⊖ 10	⊖ 12	437	304	Rear
23989	⊥ ⊖	⊥	⊖ 14	418	305	Rear
V2509	⊖ ⊖	⊖ 16 x 38	⊖ 16 x 38	462	305	Rear
<i>D7639 - D7639S</i>	○ ⊖	○ 16	⊖ 12 x 38	496	306	Rear
37310ST	⊥ ⊖	⊥ 10	⊖ 12	423,672	306,324	Rear
<i>D7021S ></i>	○ ○	⊖ 12 x 32	⊖ 12 x 36	499	307	Rear
D8021S	⊥ ○	⊥	○ 16	491	307	Rear
D8028S	⊖ ⊖	⊖ 14 x 43	⊖ 14 x 43	482	307	Rear
<i>D8645 - D8645S</i>	⊖ T	⊖ 12 x 44	⊥	483	308	Rear
G1168	○ ○	⊖ 10	⊖ 12	469	309	Rear
<u>V1207</u>	⊖ ⊖	⊖ 16 x 64	⊖ 16 x 38	456	309	Rear
RS999342	⊥ T	⊥ 13	⊥ 13	461,518	309,88	Front
23872	⊥ ⊖	⊥	⊖ 12	444	310	Front
D9004 > D9004A >	⊥ ⊖	⊥	⊖ 10 x 40	463	310	Rear
G1108A	○ ⊙	⊖ 10 x 75	⊙	466	311	Rear
37323ST	⊥ ⊖	⊥ 13	⊖	495,808	311,15	Rear
43107	⊖ ⊖	⊖ 12	⊖ 12	405	313	Rear
23990	⊖ ⊖	⊖ 14	⊖ 12	452	314	Rear

Key

*	See important installation information on inside front cover
!	Excluding self-levelling suspension
"..."	Special order – phone 010 900 1850. 6-12 week waiting period

~	Imported
#	Internal bump stop
⊕	Steering damper

- It is recommended that all new shock absorbers are fitted in pairs
- Do not mix gas and non-gas units on the same axle
- **Bold** part numbers indicate heavy-duty shocks
- Underlined part numbers indicate parts not immediately available
- *Italic* part numbers followed by > indicate parts to be discontinued

Monroe shock absorbers

Telescopic shocks – Grouping by closed length [numerical listing]

Part number	Mounting information	Top mounting	Bottom mounting	Open length (mm)	Closed length (mm)	Position
V1170	⊖ ⊖	⊖ 12 x 40	⊖ 14 x 40	472	314	Rear
23966	○ ○	⊖ 10	⊖ 14	468	315	Rear
23967	⊖ ⊖	⊖ 10	⊖ 10	481	315	Rear
G2108	○ ○	○ 10	○ 12	469	315	Rear
G43152	⊖ ⊖	⊖ 12 x 40	⊖ 12 x 34	393	315	Rear
V1177	⊖ ⊖	⊖ 14 x 40	⊖ 12 x 40	505	315	Rear
V2131	⊖ ⊖	⊖ 16 x 40	⊖ 16 x 40	475	315	Rear
F5085	⊖ ⊖	⊖ 20 x 50	⊖ 20 x 50	445	315	Rear
<u>V2136</u>	⊖ ⊖	⊖ 16 x 38	⊖ 16 x 44	478	316	Rear
V2507	⊖ ⊖	⊖ 16 x 38	⊖ 16 x 38	489	316	Rear
V1167	⊖ ⊖	⊖ 14 x 50	⊖ 14x 40	479	317	Rear
37135	⊖ ⊖	⊖ 9 x 81	⊖ 13	498,348	317,5	Rear
37272ST	⊥ ⊖	⊥ 10 x 75	⊖ 16 x 38	497	318	Rear
<i>D7640 > D7640S</i>	⊥ ○	⊥	○ 16	518	318	Rear
GT1069	⊖ ⊖	⊖ 12	⊖ 12	499	318	Rear
GT2008	○ ○	○ 16	○ 16	517	318	Rear
V1191	⊖ ⊖	⊖ 16 x 38	⊖ 16 x 38	509	318	Rear
23965	⊥ ⊖	⊥	⊖ 18	514	319	Rear
M8038	○ ○	○ 16	○ 16	515	319	Rear
V1116	⊖ ⊖	⊖ 14 x 40	⊖ 12 x 40	522	319	Rear
<i>R1568</i>	⊖ ⊖	⊖ 10	⊖ 12	493	320	Rear
<i>D7034 > D7034S</i>	⊖ ●	⊖	●	469	320	Rear
GT1029	⊥ ⊖	⊥ 11	⊖ 10	449	320	Rear
V2158	⊖ ⊖	⊖ 16 x 84	⊖ 16 x 52	402	320	Rear
<u>V2159</u>	⊖ ⊖	⊖ 16 x 84	⊖ 16 x 52	402	320	Front
<i>D8015 > D8015S</i>	⊥ ⊖	⊥	⊖ 20 x 40	509	321	Rear
V1166	⊖ ⊖	⊖ 14 x 55	⊖ 14x 40	518	321	Rear

Key

*	See important installation information on inside front cover
!	Excluding self-levelling suspension
"..."	Special order – phone 010 900 1850. 6-12 week waiting period

~	Imported
#	Internal bump stop
⊖	Steering damper

- It is recommended that all new shock absorbers are fitted in pairs
- Do not mix gas and non-gas units on the same axle
- **Bold** part numbers indicate heavy-duty shocks
- Underlined part numbers indicate parts not immediately available
- *Italic* part numbers followed by > indicate parts to be discontinued

Monroe shock absorbers

Telescopic shocks – Grouping by closed length [numerical listing]

Part number	Mounting information	Top mounting	Bottom mounting	Open length (mm)	Closed length (mm)	Position
V1502	⊖ ⊖	⊖ 16 x 38	⊖ 16 x 38	408	321	Front
F5084	⊖ ⊖	⊖ 20 x 55	⊖ 20 x 55	476	321	Rear
F5084	⊖ ⊖	⊖ 20 x 55	⊖ 20 x 55	476	321	Rear
<i>D8343</i> > D8343S	⊥ ○	⊥	○ 20 x 45	509	322	Rear
G1337	⊖ ⊙	⊖ 10 x 75	⊙	481	322	Rear
<u>V1201</u>	⊖ ⊖	⊖ 16 x 44	⊖ 16 x 44	401	322	Front
M6628	⊥ T	⊥ 38	⊥ 38	544	323	Front
M8355	○ ⊖	○ 16	⊖ 16 x 38	515	323	Rear
37027	⊖ ○	⊖ 9 x 81	○ 16	508	323,85	Rear
37083	⊥ ⊖	⊥ 9	⊖ 8 x 62	536,448	323,85	Front
M6628	⊥ T	⊥	⊥	544	324	Front
D7018S	⊖ ⊖	⊖ 12 x 64	⊖ 12 x 45	482	324	Rear
D7019S	⊖ ⊖	⊖ 12 x 64	⊖ 12 x 45	507	324	Rear
GT2034	○ ○	○ 16	○ 16	538	326	Rear
F5004	⊖ ⊖	⊖ 24 x 55	⊖ 24 x 55	496	326	Rear
F5004	⊖ ⊖	⊖ 24 x 55	⊖ 24 x 55	496	326	Rear
37026	⊥ ⊖	⊥ 9	⊖ 8 x 62	517,398	326,898	Front
<u>D4437S</u>	○ T	○ 16	⊥	523	328	Rear
V1208	⊖ ⊖	⊖ 14 x 80	⊖ 12 x 40	530	328	Rear
R2030	⊥ ○	⊥	○ 16	547	329	Rear
V1178	⊖ ⊖	⊖ 14 x 40	⊖ 14 x 40	520	330	Rear
65107	⊥ ⊖	⊥ 16	○ 25	527	330	Front
V1133	⊖ ⊖	⊖ 14 x 40	⊖ 14 x 40	538	330	Rear
G1272	⊥ ⊖	⊥	⊖	530	331	Rear
GT2031	○ ○	○ 16	○ 16	539	331	Rear
M8059	○ ○	○ 16	○ 16	537	331	Rear
GT2018	⊖ ⊖	⊖ 10	⊖ 10	541	332	Rear

Key

*	See important installation information on inside front cover
!	Excluding self-levelling suspension
"..."	Special order – phone 010 900 1850. 6-12 week waiting period

~	Imported
#	Internal bump stop
⊕	Steering damper

- It is recommended that all new shock absorbers are fitted in pairs
- Do not mix gas and non-gas units on the same axle
- **Bold** part numbers indicate heavy-duty shocks
- Underlined part numbers indicate parts not immediately available
- *Italic* part numbers followed by > indicate parts to be discontinued

Monroe shock absorbers

Telescopic shocks – Grouping by closed length [numerical listing]

Part number	Mounting information	Top mounting	Bottom mounting	Open length (mm)	Closed length (mm)	Position
V1132	⊥ ⊕	⊥	⊕ 14 x 40	569	332	Front
D7004S	⊥ ⊕	⊥	⊕ 12 x 30	545	333	Rear
<i>D7699 ></i>	⊥ ⊕	⊥	⊕ 12 x 30	545	333	Rear
GT1025	⊥ ⊕	⊥ 10	⊕ 10	558	333	Rear
AU160604	○ ⊕	○ 16	⊕ 14	538	334	Rear
GT1027	⊥ ⊕	⊥ 11	⊕ 10	552	334	Rear
GT2019	⊕ ⊕	⊕ 12 x 42	⊕ 12 x 42	529	334	Rear
RS999341	○ ○	○ 16	○ 16	509	334	Rear
GT2024	○ ○	○ 16	○ 16	558	335	Rear
23957	⊕ ⊕	⊕ 12	⊕ 14	520	336	Rear
D7020S	⊕ ⊕	⊕ 12 x 38	⊕ 12 x 38	530	336	Rear
<i>D7021S</i>	⊕ ⊕	⊕ 12 x 38	⊕ 12 x 38	530	336	Rear
<i>D8644 > D8644S</i>	⊕ T	⊕ 12 x 44	⊥	541	336	Front
M8067	⊥ ○	⊥ 10	○ 19	554	336	Rear
66639MM	⊥ ○	⊥ 10	○ 16	559	336	Front
GT2102	○ ○	○ 16	○ 19	560	337	Rear
M8032	⊕ ⊕	⊕ 16 x 36	⊕ 16 x 36	550	337	Rear
65144MM	⊕ ⊕	⊕ 16	⊕ 16	514	337	Front
RS999113	○ ○	○ 16	○ 16	509	337	Rear
M8089	○ ○	○ 16	○ 16	548	338	Rear
<i>376055SP ></i>	⊕ ⊕	⊕ 10,2 x 39,9	⊕ 14,2 x 39,4	514	339	Rear
M4434	⊥ ○	⊥ 10	○ 20	559	339	Front
RS999339	⊥ T	⊥ 10	⊥ 10	546	340	Front
376136SP	⊕ ⊕	⊕ (extended neck)	⊕	487	340	Rear
<i>D4001 ></i>	⊥ ⊕	⊥	⊕ 12 x 62	541	340	Front
<u>G1257</u>	⊕ ⊕	⊕ (extended neck)	⊕	487	340	Rear
GT1024	⊥ ⊕	⊥ 10	⊕ 10	569	340	Rear

Key

*	See important installation information on inside front cover
!	Excluding self-levelling suspension
"..."	Special order – phone 010 900 1850. 6-12 week waiting period

~	Imported
#	Internal bump stop
⊕	Steering damper

- It is recommended that all new shock absorbers are fitted in pairs
- Do not mix gas and non-gas units on the same axle
- **Bold** part numbers indicate heavy-duty shocks
- Underlined part numbers indicate parts not immediately available
- *Italic* part numbers followed by > indicate parts to be discontinued

Monroe shock absorbers

Telescopic shocks – Grouping by closed length [numerical listing]

Part number	Mounting information	Top mounting	Bottom mounting	Open length (mm)	Closed length (mm)	Position
66675MM	⊥ ○	⊥ 13	○ 19	559	340	Front
RS999128	⊥ ⊕	⊥ 10	⊕ 10	521	340	Front
GT2112	⊖ ⊖	⊖ 20	⊖ 16	541	341	Rear
M4441	○ ○	○ 16	○ 16	555	341	Rear
M8073	⊖ ⊖	⊖ 20 x 43	⊖ 16 x 48	551	341	Rear
M8074	○ ○	○ 16	○ 19	560	341	Rear
V2110	⊖ ⊖	⊖ 16 x 38	⊖ 16 x 38	543	341	Rear
RS999307	⊥ T	⊥ 13	SPEC	374	341	Front
RS999339	⊥ T	⊥	⊥	550	344	Front
M4464	⊥ ○	⊥ 10	○ 16	574	344	Front
M6629	⊖ T	⊖ 19	⊥ 14	564	344	Rear
V2514	⊖ ⊖	⊖ 12 x 32	⊖ 14 x 32	550	344	Rear
V2514	⊖ ⊖	⊖ 12 x 32	⊖ 14 x 32	550	344	Rear
D8018S	⊥ ⊖	⊥	⊖ 14 x 39	378	345	Front
RS999187	⊥ ○	⊥ 9	○ 10	523	345	Rear
T1216	⊥ ⊖	⊥	⊖ 20 x 50	554	345	Rear
911266MM	⊥ ○	⊥ 13	○ 14	527	346	Front
GT2036	○ ○	○ 16	○ 16	584	346	Rear
GT2109	⊖ ⊖	⊖ 20	⊖ 20	557	346	Rear
RS999762	⊥ ⊖	⊥ 13	⊖ 14	463	347	Front
M8029	○ ○	○ 16	○ 16	570	347	Rear
RS999241	⊕ ⊖	⊕ 10	⊖ 10	532,13	347,726	Rear
23968	⊥ ⊖	⊥	⊖ 10	510	348	Rear
GT2027	⊥ ⊖	⊥ 10	⊖ 12	546	349	Rear
376032SP	⊥ ⊖	⊥	⊖ 12	533	350	Rear
M8042	○ ○	○ 16	○ 16	575	350	Rear
<u>V2152</u>	⊖ ⊖	⊖ 16 x 38	⊖ 16 x 38	502	350	Rear

Key

*	See important installation information on inside front cover
!	Excluding self-levelling suspension
"..."	Special order – phone 010 900 1850. 6-12 week waiting period

~	Imported
#	Internal bump stop
⊕	Steering damper

- It is recommended that all new shock absorbers are fitted in pairs
- Do not mix gas and non-gas units on the same axle
- **Bold** part numbers indicate heavy-duty shocks
- Underlined part numbers indicate parts not immediately available
- *Italic* part numbers followed by > indicate parts to be discontinued

Monroe shock absorbers

Telescopic shocks – Grouping by closed length [numerical listing]

Part number	Mounting information	Top mounting	Bottom mounting	Open length (mm)	Closed length (mm)	Position
RS999354	⊥ ○	⊥ 13	○ 19	548	351	Rear
R1566	⊥ ⊕	⊥	⊖ 10	607	351	Rear
AU161704	⊥ ○	⊥ 10	○ 19	591	351	Front
V1018	⊖ ⊖	⊖ 12 x 32	⊖ 12 x 32	594	351	Rear
RS999311	○ ⊖	○ 16	⊖ 14	536	352	Rear
GT2210	⊥ ⊖	⊥	⊖ 14	585	352	Rear
<i>D4002</i> >	○ ⊖	○ 16	⊖ 13 x 38	539	353	Rear
D8079S	⊖ ⊖	⊖ 12 x 42	⊖ 12 x 42	566	353	Rear
<u>G1081</u>	⊖ ⊖	⊖ 10 x 38	⊖ 12 x 42	571	353	Rear
GT2534	○ ○	○ 19	○ 19	564	353	Rear
V2515	⊖ ⊖	⊖ 16 x 38	⊖ 16 x 38	573	353	Rear
D8019S	⊥ ○	⊥	○ 20	573	354	Rear
GT2015	⊥ ○	⊥	○ 18	601	354	Rear
GT2044	⊖ ⊖	○ 16	○ 16	598	354	Rear
GT2093	○ ○	○ 19	○ 19	545	354	Rear
AU160461	⊖ ⊖	⊖ 125	⊖ 125	565	355	Rear
<i>D7011</i> > <i>D7011S</i>	○ ⊖	○ 16	⊖ 12 x 38	537	355	Rear
G1102	⊥ ⊖	⊥	⊖ 12	565	355	Rear
37203	⊖ ⊖	⊖ 12	⊖ 12	556	356	Rear
<i>D8023</i> > <i>D8023S</i>	⊥ ⊖	⊥	⊖ 28 x 45	585	356	Rear
911536MM	⊥ ⊖	⊥ 10	⊖ 12	557	356	Front
AU150537	⊖ ⊖	⊖ 125	⊖ 145	526	357	Rear
G1067	⊥ ⊖	⊥	⊖ 12	600	357	Rear
T1359	⊥ ⊖	⊥	⊖ 16 x 50	573	357	Front
RS999326	⊥ ⊖	⊥ 13	⊖ 13	553	358	Front
G1095	⊥ ⊖	⊥	⊖ 12	605	359	Rear
T1142	⊥ T	⊥	⊥	607	359	Front

Key

*	See important installation information on inside front cover
!	Excluding self-levelling suspension
"..."	Special order – phone 010 900 1850. 6-12 week waiting period

~	Imported
#	Internal bump stop
⊕	Steering damper

- It is recommended that all new shock absorbers are fitted in pairs
- Do not mix gas and non-gas units on the same axle
- **Bold** part numbers indicate heavy-duty shocks
- Underlined part numbers indicate parts not immediately available
- *Italic* part numbers followed by > indicate parts to be discontinued

Monroe shock absorbers

Telescopic shocks – Grouping by closed length [numerical listing]

Part number	Mounting information	Top mounting	Bottom mounting	Open length (mm)	Closed length (mm)	Position
23972	⊥ ⊕	⊥	⊖ 12	600	360	Rear
376015SP	⊥ ⊕	⊥	⊖	483	360	Rear (no dust cover)
G1157	⊖ ⊖	⊖ 12	⊖ 14	540	360	Rear
G1347	⊥ ⊕	⊥	⊖	567	360	Rear (no dust cover)
<u>V2151</u>	⊖ ⊖	⊖ 16 x 38	⊖ 16 x 44	462	360	Rear
AU160499	○ ⊥	○ 19	⊥ 10	611	361	Rear
M8085	⊖ ⊖	⊖ 20 x 43	⊖ 12 x 40	578	361	Rear
RS999340	⊖ T	⊖ 19	⊥ 13	559	362	Rear
GT2022	⊥ ○	⊥ 10	○ 16	610	362	Rear
M8056	○ ○	○ 19	○ 19	568	362	Rear
<i>V2505</i>	⊖ ⊖	⊖ 12 x 42	⊖ 12 x 42	587	362	Rear
911195MM	○ ⊖	○ 16	⊖ 12	581	363	Front
RS999365	⊥ ⊕	⊥ 10	⊖ 14	576	363	Rear
<u>G1351</u>	⊥ ⊕	⊥	⊖	573	364	Rear (no dust cover)
M8353	⊥ ○	⊥ 10	○ 19	565	364	Rear
AU160460	⊖ ⊖	⊖ 125	⊖	575	365	Front
M4445	○ ○	○ 20	○ 20	595	365	Rear
5794ST	⊥ ⊕	⊥ 10	⊖	614,68	365,252	Rear
M6902	○ ○	○ 16	○ 16	606	366	Rear
M7367	⊖ ⊖	⊖ 20 x 42	⊖ 12 x 40	606	366	Rear
RS999357	⊥ ⊕	⊥ 9	○ 10	580	366	Rear
T1223	⊥ T	⊥ 14	⊥ 14	627	366	Front
RS999144	○ ○	○ 19	○ 19	556	365	Rear
<i>376027SP ></i>	⊥ ⊕	⊥	⊖ 14 x 37	582	367	Rear (no dust cover)
G1075	⊥ ⊕	⊥	⊖ 10	607	367	Rear
GT2046	○ ○	○ 20	○ 20	603	367	Rear
V1197	⊖ ⊖	⊖ 16 x 44	⊖ 16 x 44	400	368	Front

Key

*	See important installation information on inside front cover
!	Excluding self-levelling suspension
"..."	Special order – phone 010 900 1850. 6-12 week waiting period

~	Imported
#	Internal bump stop
⊕	Steering damper

- It is recommended that all new shock absorbers are fitted in pairs
- Do not mix gas and non-gas units on the same axle
- **Bold** part numbers indicate heavy-duty shocks
- Underlined part numbers indicate parts not immediately available
- *Italic* part numbers followed by > indicate parts to be discontinued

Monroe shock absorbers

Telescopic shocks – Grouping by closed length [numerical listing]

Part number	Mounting information	Top mounting	Bottom mounting	Open length (mm)	Closed length (mm)	Position
65492	⊖ ⊖	⊖ 16	⊖ 16	555	368	Rear
V1188	⊖ ⊖	⊖ 14 x 40	⊖ 14 x 40	559	369	Rear
<i>376099SP ></i>	⊥ ⊖	⊥	⊖ 14 x 36	585	370	Rear
M8075	⊥ ○	⊥ 10 x 52	○ 16	618	370	Rear
RS999305	⊥ ○	⊥ 13	○ 19	571	370	Rear
RS999239	⊥ ⊕	⊥ 10	⊕ 10	587	372	Front
65148	⊖ ⊖	⊖ 19	⊖ 19	578	372	Front
RS999207	⊥ T	⊥ 13	⊥ 13	593	373	Front
911538MM	⊕ ⊖	⊕	⊖ 12	573	373	Rear
RS999328	⊕ ⊖	⊕ 10	⊖ 13	574	373	Rear
<i>D4003 > D4003S</i>	⊥ ⊖	⊥	⊖ 15 x 66	473	375	Rear
<i>D8020 > D8020S</i>	⊥ ⊖	⊥	⊖ 16 x 38	596	375	Rear (no dust cover)
RS999208	⊥ ○	⊥ 13	○ 19	589	377	Rear
G1074	⊥ ○	⊥	⊖ 10	622	377	Rear
V1501	⊖ ⊖	⊖ 14 x 40	⊖ 14 x 40	488	377	Rear
T5052	⊥ ⊖	⊥	⊖ 20 x 50	622	377	Front
T5053	⊥ ⊖	⊥	⊖ 20 x 50	622	377	Front
376000SP	⊥ ⊖	⊥	⊖	636	378	Rear (no dust cover)
M8052	○ ○	○ 16	○ 16	635	378	Rear
T1313	⊖ ⊖	⊖ 16 x 50	⊖ 16 x 50	599	378	Rear
V1095	⊖ ⊖	⊖ 14 x 40	⊖ 14 x 40	623	378	Front
M8087	⊖ ⊖	⊖ 20 x 43	⊖ 12 x 40	617	379	Rear
M6409	○ ○	○ 20	○ 20	620	381	Rear
RS999778	⊥ ⊖	⊥	⊖	493	381	Front
65490	⊖ ⊖	⊖ 19	⊖ 19	568	381	Front
G1158	⊥ ○	⊥	⊖ 15	614	382	Rear
43071	⊥ ⊖	⊥ 10	⊖ 10	508	383	Rear

Key

*	See important installation information on inside front cover
!	Excluding self-levelling suspension
"..."	Special order – phone 010 900 1850. 6-12 week waiting period

~	Imported
#	Internal bump stop
⊕	Steering damper

- It is recommended that all new shock absorbers are fitted in pairs
- Do not mix gas and non-gas units on the same axle
- **Bold** part numbers indicate heavy-duty shocks
- Underlined part numbers indicate parts not immediately available
- *Italic* part numbers followed by > indicate parts to be discontinued

Monroe shock absorbers

Telescopic shocks – Grouping by closed length [numerical listing]

Part number	Mounting information	Top mounting	Bottom mounting	Open length (mm)	Closed length (mm)	Position
376063SP >	⊥ ⊕	⊥	⊖ 14 x 37	632	384	Rear (no dust cover)
911278MM	⊖ ⊖	⊖ 12	⊖ 13	616	384	Rear
G1364	⊥ ⊕	⊥	⊖ 14 x 37	632	384	Rear (no dust cover)
RS999116	○ ○	○ 16	○ 16	603	385	Rear
G1136	⊥ ⊕	⊥	⊖ 12	595	385	Rear
RS999321	⊖ ⊖	⊖	⊖ 12	597	385	Rear
RS999308	⊖ ⊖	⊖ 10	⊖ 14	597	3867	Rear
RS999202	○ ○	○ 19	○ 19	599	388	Rear
<i>D4484 > D4484S</i>	○ ⊖	○ 20	⊖ 19 x 44	613	388	Rear
G11072	⊥ ○	⊥	⊖ 12	567	388	Rear
M8097	○ ○	○ 19	○ 19	620	389	Rear
<u>G1350</u>	⊥ ⊕	⊥	⊖	594	390	Rear (no dust cover)
G21659	⊥ ⊕	⊥	⊖ 12	633	390	Rear
65407MM	⊖ ⊖	⊖ 25	⊖ 25	600	390	Rear
43081	⊥ ⊕	⊥	⊖ 10	500	391	Rear
376252SP	⊥ ⊕	⊥	⊖ 14	590	391	Rear
B5434	○ T	⊖ 16 x 100	⊥	646	391	Front
5621ST	⊥ ⊕	⊥ 9	⊖ 12 x 55	604	393	Rear
G2217	⊥ ⊕	⊥	⊖ 10	652	393	Rear (no dust cover)
V1195	⊖ ⊖	⊖ 16 x 38	⊖ 16 x 38	415	393	Front
T1344	⊖ ⊖	⊖ 12 x 80	⊖ 16 x 50	636	393	Rear
G1037	⊥ ⊕	⊥	⊖ 12	650	394	Rear
G1091	⊥ ⊕	⊥	⊖ 12	603	394	Rear
G1099	⊥ ⊕	⊥	⊖ 12	651	394	Rear
43095	⊖ ⊖	⊖ 15	⊖ 15	467	395	Rear
G1098	⊥ ⊕	⊥	⊖ 10	624	396	Rear
T1189	⊥ ⊕	⊥ 14	⊖ 16 x 50	647	396	Front

Key

*	See important installation information on inside front cover
!	Excluding self-leveling suspension
"..."	Special order – phone 010 900 1850. 6-12 week waiting period

~	Imported
#	Internal bump stop
⊕	Steering damper

- It is recommended that all new shock absorbers are fitted in pairs
- Do not mix gas and non-gas units on the same axle
- **Bold** part numbers indicate heavy-duty shocks
- Underlined part numbers indicate parts not immediately available
- *Italic* part numbers followed by > indicate parts to be discontinued

Monroe shock absorbers

Telescopic shocks – Grouping by closed length [numerical listing]

Part number	Mounting information	Top mounting	Bottom mounting	Open length (mm)	Closed length (mm)	Position
25504	⊥ ⊕	⊥	⊖ 10	644	397	Rear (no dust cover)
T1029	⊥ ⊕	⊥	⊖ 16 x 50	671	397	Front
GT1006	⊥ ⊕	⊥ 10	⊖ 15 x 55	598	398	Rear (no dust cover)
G1154	⊥ ⊕	⊥	⊖ 14	640	400	Rear
65409	⊖ ⊖	⊖ 16	⊖ 16	641	400	Rear
R6652	⊥ ⊕	⊥	⊖ 12	579	401	Rear
T1093	⊥ T	⊥	⊥	692	401	Front
T1093	⊥ T	⊥	⊥	692	401	Front
R6653	⊥ ⊕	⊥	⊖ 12	579	402	Rear
GT1376	⊥ ⊕	⊥ 10	⊖ 12 x 45	652	402	Rear (no dust cover)
T5183	⊥ T	⊥	⊥	694	402	Front
43130	⊥ ⊕	⊥	⊖ 10 x 40	493	403	Rear
M8358	○ ○	○ 16	○ 16	583	403	Rear
V2058	⊖ ⊖	⊖ 20 x 55	⊖ 20 x 55	667	403	Rear
T5183	⊥ T	⊥	⊥	695	403	Front
T5227	⊥ T	⊥	⊥	685	403	Front
T5269	⊖ ⊖	⊖ 20 x 55	⊖ 20 x 55	650	403	Rear
23910	⊥ ○	⊥	○ 16	666	405	Rear
23963	⊥ ⊕	⊥	⊖ 12	630	405	Rear
G1249	⊥ ⊕	⊥	⊖	636	405	Rear (no dust cover)
T1318	⊥ ⊕	⊥	⊖ 24 x 55	674	405	Front
23915	⊖ ⊖	⊖ 12,2 x 47,6	⊖ 14,1 x 40	265	406	Rear
23991	⊥ ○	⊥	⊖ 15	608	406	Rear
RS999143	○ ○	○ 19	○ 19	637	408	Rear
376039SP	⊥ ⊕	⊥	⊖ 10	590	408	Rear
G43155	⊥ ⊕	⊥	⊖	580	408	Rear (no dust cover)
T1101 > T1331	⊥ ⊕	⊥	⊖ 22 x 50	687	409	Front

Key

*	See important installation information on inside front cover
!	Excluding self-levelling suspension
“...”	Special order – phone 010 900 1850. 6-12 week waiting period

~	Imported
#	Internal bump stop
⊕	Steering damper

- It is recommended that all new shock absorbers are fitted in pairs
- Do not mix gas and non-gas units on the same axle
- **Bold** part numbers indicate heavy-duty shocks
- Underlined part numbers indicate parts not immediately available
- *Italic* part numbers followed by > indicate parts to be discontinued

Monroe shock absorbers

Telescopic shocks – Grouping by closed length [numerical listing]

Part number	Mounting information	Top mounting	Bottom mounting	Open length (mm)	Closed length (mm)	Position
T1145	⊥ ⊕	⊥	⊖ 22 x 46	691	410	Front
G55019	⊖ ⊖	⊖ 15 x 59	⊖ 12 x 63	470	411	Rear
T1255	⊖ ⊖	⊖ 14 x 50	⊖ 14 x 40	691	411	Front
376213SP	⊥ ⊖	⊥	⊖ 15	628	412	Rear
T5429	⊖ ⊖	⊖ 20 x 62	⊖ 30 x 62	648	412	Rear
37313ST	⊥ ⊖	⊥ 9	⊖ 12	546	413	Rear
T1330	⊥ ○	⊥	○ 22	687	413	Front
65103	⊖ ⊖	⊖ 25	⊖ 25	669	415	Front
74073	○ ○	○ 25	○ 25	665	415	Front
B1279	⊖ ⊖	⊖ 16 x 100	⊖ 16 x 66	656	415	Rear
5540ST	⊥ ⊖	⊥ 10	⊖ 12	654	415	Rear
<u>5515ST</u>	⊥ ⊖	⊥ 8	⊖ 20	656	415	Rear
<u>G138Z</u>	⊥ ⊖	⊥	⊖	672	416	Rear (no dust cover)
376135SP	⊖ ⊖	⊖	⊖	274	417	Rear
T1190	⊥ ⊖	⊥	⊖ 16,1 x 50	681	417	Front
T1190	⊥ ⊖	⊥	⊖ 16,1 x 50	681	417	Front
T5178	⊖ ⊖	⊖ 16 x 62	⊖ 20 x 62	668	417	Rear
G1345	⊥ ⊖	⊥	⊖	647	418	Rear (no dust cover)
GT1002	⊥ ⊖	⊥ 10	⊖	669	418	Rear (no dust cover)
T5277	⊖ ⊖	⊖ 20 x 62	⊖ 20 x 62	668	418	Rear
G1339	⊥ ⊖	⊥	⊖ 10 x 45	616	420	Rear (no dust cover)
G1339	⊥ ⊖	⊥	⊖ 10 x 45	616	420	Rear (no dust cover)
<u>G2241</u>	⊥ ⊖	⊥	⊖ 10 x 55	650	420	Rear (no dust cover)
G43142	⊥ ⊖	⊥	⊖ 10	463	420	Rear
GT1003	⊥ ⊖	⊥ 10	⊖	632	420	Rear (no dust cover)
T1273	⊖ ⊖	⊖ 16 x 62	⊖ 16 x 50	696	420	Rear
23896	⊥ ⊖	⊥	⊖ 12	567	421	Rear

Key

*	See important installation information on inside front cover
!	Excluding self-levelling suspension
"..."	Special order – phone 010 900 1850. 6-12 week waiting period

~	Imported
#	Internal bump stop
⊕	Steering damper

- It is recommended that all new shock absorbers are fitted in pairs
- Do not mix gas and non-gas units on the same axle
- **Bold** part numbers indicate heavy-duty shocks
- Underlined part numbers indicate parts not immediately available
- *Italic* part numbers followed by > indicate parts to be discontinued

Monroe shock absorbers

Telescopic shocks – Grouping by closed length [numerical listing]

Part number	Mounting information	Top mounting	Bottom mounting	Open length (mm)	Closed length (mm)	Position
T5349	⊖ ⊖	⊖ 20 x 62	⊖ 20 x 62	668	421	Rear
376113SP	⊥ ○	⊥	○ 12	626	423	Rear
T5386	⊥ ⊖	⊥	⊖ 20 x 62	672	423	Rear
G1153	⊥ ⊖	⊥	⊖ 15	688	425	Rear
<u>G2244</u>	⊥ ⊖	⊥	⊖	640	425	Rear (no dust cover)
RS999777	⊥ ⊖	⊥	⊖	559	425	Front
T1069	⊖ ⊖	⊖ 14 x 50	⊖ 14 x 40	676	425	Front
<u>5546ST</u>	⊥ ⊖	⊥ 8	⊖ 14	672	426	Rear
23904	⊥ ⊖	⊥	⊖ 12	636	426	Rear
T1321	⊖ ⊖	⊖ 20 x 105	⊖ 24 x 55	701	428	Front
<u>G1368</u>	⊥ ⊖	⊥	⊖ 10 x 45	638	429	Rear (no dust cover)
5530ST	⊥ ⊖	⊥ 10	⊖ 25	672	429	Rear
RS999782	⊥ ⊖	⊥ 13	⊖ 14	555	429	Front
T1333	⊖ ⊖	⊖ 20 x 105	⊖ 24 x 55	661	430	Front
T1256	⊖ ⊖	⊖ 14 x 62	⊖ 16 x 50	726	431	Rear
M8066	⊥ ⊖	⊥ 12 x 67	⊖ 14 x 39	552	432	Front
<i>D8080 > D8080S</i>	⊥ T	⊥	⊥	585	433	Rear (no dust cover)
T1320	⊖ ⊖	⊖ 20 x 105	⊖ 24 x 55	714	433	Front
T1320	⊖ ⊖	⊖ 20 x 105	⊖ 24 x 55	714	433	Front
376051SP	⊥ ⊖	⊥	⊖ 10	521	434	Rear
GT1231	⊥ ⊖	⊥ 10	⊖ 10 x 45	649	434	Rear
43125	⊥ ⊖	⊥	⊖ 12	671	435	Rear
D4005S	⊥ ⊖	⊥	⊖ 12 x 40	648	435	Rear (no dust cover)
F1241	⊖ ⊖	⊖ 20 x 55	⊖ 20 x 55	714	435	Rear
T1261	⊥ ⊖	⊥	⊖ 16 x 50	746	435	Front
T1353	⊖ ⊖	⊖ 20 x 105	⊖ 16 x 50	711	435	Front
T1246	⊖ ⊖	⊖ 14 x 50	⊖ 14 x 40	726	436	Front

Key

*	See important installation information on inside front cover
!	Excluding self-levelling suspension
"..."	Special order – phone 010 900 1850. 6-12 week waiting period

~	Imported
#	Internal bump stop
⊖	Steering damper

- It is recommended that all new shock absorbers are fitted in pairs
- Do not mix gas and non-gas units on the same axle
- **Bold** part numbers indicate heavy-duty shocks
- Underlined part numbers indicate parts not immediately available
- *Italic* part numbers followed by > indicate parts to be discontinued

Monroe shock absorbers

Telescopic shocks – Grouping by closed length [numerical listing]

Part number	Mounting information	Top mounting	Bottom mounting	Open length (mm)	Closed length (mm)	Position
<u>T5358</u>	⊖ ⊖	⊖ 20 x 105	⊖ 20 x 50	711	436	Rear
T5358	⊖ ⊖	⊖ 20 x 105	⊖ 20 x 50	711	436	Rear
T5358	⊖ ⊖	⊖ 20 x 105	⊖ 20 x 50	711	436	Rear
<u>T5358</u>	⊖ ⊖	⊖ 20 x 105	⊖ 20 x 50	711	436	Rear
44001	⊥ ⊖	⊥	⊖ 12 x 40	670	437	Rear
B1343	⊖ ⊖	⊖ 16 x 100	⊖ 20 x 50	706	437	Front
D4004S	⊥ ⊖	⊥	⊖ 15 x 66	616	438	Rear (no dust cover)
T1346	⊖ ⊖	⊖ 16 x 50	⊖ 16 x 50	714	438	Front
376025SP	⊥ ⊖	⊥	⊖	666	439	Rear (no dust cover)
376048SP	⊥ ⊖	⊥	⊖ 14	666	439	Rear
B5296	⊖ ⊖	⊖ 16 x 100	⊖ 20 x 50	709	441	Front
T5171	⊖ ⊖	⊖ 20 x 105	⊖ 20 x 50	724	444	Front
G1116	⊥ ⊖	⊥	⊖ 16	676	445	Rear
T5360	⊖ ⊖	⊖ 16 x 50	⊖ 16 x 50	729	446	Front
43093	⊖ ⊖	⊖ 14,6 x 58,6	⊖ 14,5 x 34	382	448	Rear
911267MM	○ ⊖	⊖ 16	⊖ 12	752	448	Rear
T5400	⊖ ⊖	⊖ 20 x 62	⊖ 30 x 62	723	449	Rear
G43141	⊥ ⊖	⊥	⊖ 10	478	450	Front
T5444	⊖ ⊥	⊖ 16 x 100	⊥	766	451	Rear
T5350	⊖ ⊖	⊖ 20 x 62	⊖ 20 x 62	733	453	Rear
T1149	⊖ ⊖	⊖ 16 x 100	⊖ 16 x 66	721	455	Front
23443	○ ○	○ 16	○ 16	293	456	Rear
T1177	⊖ ⊖	⊖ 16 x 100	⊖ 16 x 66	721	456	Front
T5403	⊖ ⊖	⊖ 20 x 62	⊖ 20 x 50	744	456	Rear
T5403	⊖ ⊖	⊖ 20 x 62	⊖ 20 x 50	744	456	Rear
65488MM	⊖ ⊖	⊖ 16	⊖ 16	660	457	Rear
65488MM	⊖ ⊖	⊖ 16	⊖ 16	660	457	Rear

Key

*	See important installation information on inside front cover
!	Excluding self-leveling suspension
"..."	Special order – phone 010 900 1850. 6-12 week waiting period

~	Imported
#	Internal bump stop
⊕	Steering damper

- It is recommended that all new shock absorbers are fitted in pairs
- Do not mix gas and non-gas units on the same axle
- **Bold** part numbers indicate heavy-duty shocks
- Underlined part numbers indicate parts not immediately available
- *Italic* part numbers followed by > indicate parts to be discontinued

Monroe shock absorbers

Telescopic shocks – Grouping by closed length [numerical listing]

Part number	Mounting information	Top mounting	Bottom mounting	Open length (mm)	Closed length (mm)	Position
65488MM	⊖ ⊖	⊖ 16	⊖ 16	660	457	Rear
T5177	⊖ ⊖	⊖ 16 x 100	⊖ 20 x 50	752	459	Rear
T5177	⊖ ⊖	⊖ 16 x 100	⊖ 20 x 50	752	459	Rear
43089	⊥ ⊖	⊥	⊖ 10	495	460	Front
T1388	⊖ ⊖	⊖ 16 x 100	⊖ 16 x 66	751	460	front
65420	⊖ ⊖	⊖ 19	⊖ 19	749	460	Rear
43080	⊥ ⊖	⊥	⊖ 10	531	461	Front
911196MM	○ ⊖	○ 16	⊖ 12	787	464	Rear
5609ST	⊥ ⊖	⊥ 9	⊖ 12	560	465	Rear
T5047	⊖ ⊖	⊖ 20 x 62	⊖ 20 x 62	750	465	Rear
376040SP	⊥ ⊖	⊥	⊖ 10	570	466	Rear
376045SP	⊥ ⊖	⊥	⊖ 10	570	466	Rear
T1210	⊖ ⊖	⊖ 16 x 105	⊖ 16 x 50	766	466	Rear
T5063	⊥ ⊖	⊥	⊖ 22 x 46	787	467	Front
43097	⊥ ⊖	⊥	⊖ 10	503	471	Rear
G43140	⊥ ⊖	⊥	⊖ 10	567	471	Rear
T5363	⊖ ⊖	⊖ 20 x 105	⊖ 20 x 50	782	472	Rear
23988	⊥ ⊖	⊥	⊖ 12	708	473	Rear
23992	⊥ ⊖	⊥	⊖ 12	717	473	Rear
T5261	⊖ ⊖	⊖ 20 x 69	⊖ 30 x 69	768	473	Rear
T5275	⊖ ⊖	⊖ 20 x 62	⊖ 30 x 62	768	473	Rear
T5137	⊖ ⊖	⊖ 20 x 105	⊖ 20 x 50	785	475	Rear
T1296	⊖ ⊖	⊖ 16 x 100	⊖ 20 x 50	804	475	Rear
T5137	⊖ ⊖	⊖ 20 x 105	⊖ 20 x 50	786	476	Rear
5607ST	⊥ ⊖	⊥	⊖ 12	670	477	Rear
T5406	⊖ ⊖	⊖ 20 x 62	⊖ 30 x 62	770	477	Rear
T5059	⊥ ⊖	⊥ 16	⊖ 20 x 50	817	477	Rear

Key

*	See important installation information on inside front cover
!	Excluding self-levelling suspension
"..."	Special order – phone 010 900 1850. 6-12 week waiting period

~	Imported
#	Internal bump stop
⊖	Steering damper

- It is recommended that all new shock absorbers are fitted in pairs
- Do not mix gas and non-gas units on the same axle
- **Bold** part numbers indicate heavy-duty shocks
- Underlined part numbers indicate parts not immediately available
- *Italic* part numbers followed by > indicate parts to be discontinued

Monroe shock absorbers

Telescopic shocks – Grouping by closed length [numerical listing]

Part number	Mounting information	Top mounting	Bottom mounting	Open length (mm)	Closed length (mm)	Position
43096	⊥ ⊕	⊥	⊖ 10	504	481	Front
T5243	⊥ ⊕	⊥	⊖ 16 x 44	819	484	Rear
376072SP	⊥ ⊕	⊥	⊖ 10	571	486	Rear
T11016	⊖ ⊖	⊖ 16 x 50	⊖ 16 x 50	804	489	Front
G1167	⊥ ⊕	⊥	⊖ 12	717	490	Rear
T1215	⊥ ⊕	⊥ 14	⊖ 20 x 50	855	490	Front
T1220	⊖ ⊖	⊖ 16 x 50	⊖ 16 x 50	806	490	Front
T1204	⊖ ⊖	⊖ 16 x 50	⊖ 16 x 50	806	491	Front
T1254	⊖ ⊖	⊖ 25 x 50	⊖ 14 x 40	820	500	Front
T1360	⊖ ⊖	⊖ 20 x 50	⊖ 20 x 50	841	500	Rear
T1207	⊖ ⊖	⊖ 16 x 50	⊖ 16 x 50	854	504	Front
<u>37161</u>	⊥ ⊕	⊥	⊖	333	514	Front
T5155	⊖ ⊖	⊖ 20 x 50	⊖ 20 x 50	840	515	Rear
T1201	⊖ ⊖	⊖ 16 x 105	⊖ 16 x 50	856	516	Rear
T5256	⊖ ⊖	⊖ 20 x 50	⊖ 20 x 50	876	521	Rear
T5266	⊖ ⊖	⊖ 20 x 62	⊖ 20 x 62	848	531	Rear
T5276	⊖ ⊖	⊖ 20 x 62	⊖ 20 x 62	893	533	Rear
T5372	⊖ ⊖	⊖ 16 x 105	⊖ 16 x 50	896	533	Rear
T5372	⊖ ⊖	⊖ 16 x 105	⊖ 16 x 50	896	533	Rear
T1308	⊖ ⊖	⊖ 20 x 105	⊖ 24 x 55	869	540	Front
T5387	⊖ ⊖	⊖ 20 x 50	⊖ 20 x 50	913	543	Rear
T5387	⊖ ⊖	⊖ 20 x 50	⊖ 20 x 50	913	543	Rear
<u>37082</u>	○ ⊕	○ 15	⊖ 12 x 36	345	544	Rear
<u>37162</u>	⊖ ⊖	⊖ 12 x 45	⊖ 12 x 36	350	554	Rear
T5144	⊖ ⊖	⊖ 20 x 50	⊖ 20 x 50	950	555	Rear
T5391	⊖ ⊖	⊖ 16 x 100	⊖ 20 x 50	949	559	Rear
<u>M8357</u>	○ ⊕	○ 16	⊖ 14 x 42	400	577	Rear
45008	⊥ ⊕	⊥	⊖ 10,2 x 59,2	386	605	Rear (no dust cover)

Key

*	See important installation information on inside front cover
!	Excluding self-levelling suspension
"..."	Special order – phone 010 900 1850. 6-12 week waiting period

~	Imported
#	Internal bump stop
⊕	Steering damper

- It is recommended that all new shock absorbers are fitted in pairs
- Do not mix gas and non-gas units on the same axle
- **Bold** part numbers indicate heavy-duty shocks
- Underlined part numbers indicate parts not immediately available
- *Italic* part numbers followed by > indicate parts to be discontinued

**BUILT
STRONGER**

**LAST
LONGER**



MONROE

DURABILITY GUARANTEED

*Limitations apply. See www.monroe.com/en-za/ for details.

TECHNICAL INFO ON GAS/OIL DISPOSAL OF OLD AND DEFECTIVE SHOCK ABSORBERS

FOR SAFETY REASONS, ALWAYS WEAR SAFETY GLASSES AND PROTECTIVE GLOVES.

- 1 Place shock absorber in a horizontal position.
- 2 Make sure the shock absorber is secure and cannot move during the drilling operation.
- 3 Before drilling, pull out the rod until fully extended.

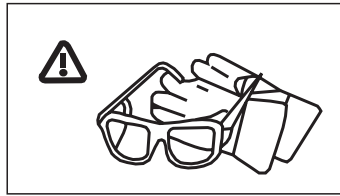

! With Ride Leveler shock absorbers, cut away the rubber sleeve and treat as twintube units.

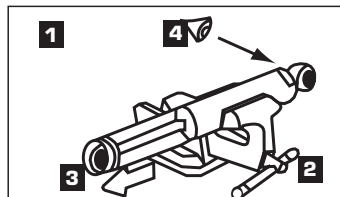

- 4 Check whether the unit is a high pressure monotube, low pressure twintube or a conventional twintube type. All high pressure monotube shock absorbers have a special marking "high pressure - do not heat or open".

FOR HIGH PRESSURE MONOTUBES (25-30 bar):

- 5 Drill a small hole of 3 to 5 mm, 2 cm from the lower body end (A) in order to remove the gas. It is quite possible that oil may be forced out of the hole whilst drilling, and therefore precaution should be taken to restrict the flow by placing a cloth

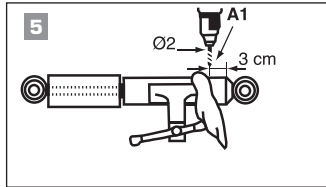
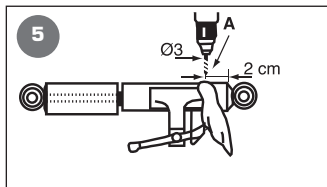

FOR LOW PRESSURE TWINTUBE (3-5 bar) or CONVENTIONAL TWINTUBE: (FIRST POINTS 1 TO 5)

- 5 Drill a hole of 2 mm, 3 cm from the lower body end in the reserve tube (A1).

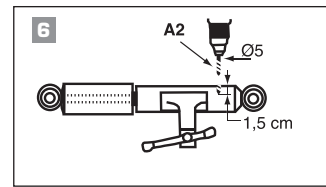
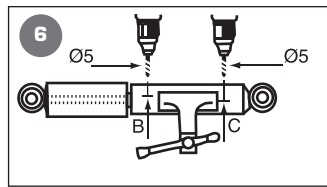

- 6 Drill two additional holes of 3 to 5 mm at (B) and (C) to remove the oil. (further at point 9)

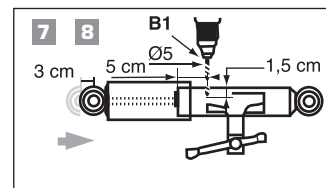

- 6 After the gas pressure is gone, drill a 1.5 cm deep hole of 5 mm at (A2).

- 9 Move piston rod up and down to accelerate oil removal.

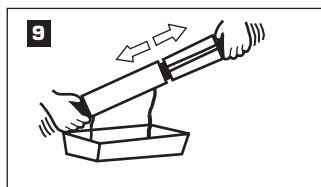

- 7 Compress the shock absorber by minimum 30 mm.



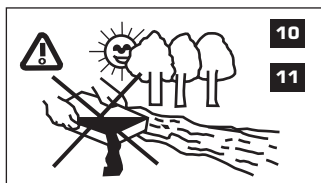

- 8 Drill another 1.5 cm deep hole of 5 mm, 5 cm from the top side (B1).

- 10 The shock absorber oil needs to be disposed of in an appropriate container (to be treated like motor oil), in accordance with the national waste disposal law.



- 11 Check with the local authorities for information about where the oil and remaining parts should be disposed of.



	Telescopic 	Sealed strut 	Strut insert/cartridge 	Spring pan unit 
OE SPECTRUM Gas + A3:B5 Now with R-Tech2® technology. Revolutionary gas-charged shocks, with built-in ultra progressive 4 speed rebound valves & helical disc. For those drivers who demand more.	37...SP (EU) AU17... (AUS) 057...->059... (USA) 37... (USA) 37...ST (USA) 57... (USA) 57...ST->059...ST (USA) 91... (USA) 92... (USA) 39... (USA) mono 911... (USA) mono	37...SP (EU) AU35... (AUS) AU37... (AUS) 71... (USA) 72... (USA) 72246 (USA) 72247 oil (USA) 72511ST (USA) 72643ST (USA) 73... (USA) 92... (USA)	71...-> 72... (USA) 71...ST (USA) 720...ST (USA) 733... (USA)	37...SP (EU) 71... (USA) 728... (USA) 73... (USA)
ORIGINAL Gas The original top quality gas pressurised or oil shocks for all passenger vehicles [includes Van-Magnum for medium commercial vehicles]	27...-> 26... (EU) 31...-> 33... (USA) GT1-> GT2... (RSA) GA... (RSA) gas adj G1...-> G2... (EU) 17... (USA) 56... (USA) 58... (USA) AU15... (AUS) 27... (ARG) 56... (USA) 94... (BRA) 83... (ARG) Mono-tube..... 40...-> 46... (EU) mono	94... (BRA & ARG) 15...-> 16... (EU) G7...-> G8... (EU) G16... (EU) AU35... (AUS) G17...-> G18... (RSA)	MG... (EU) GT0... (RSA)	23828 / 9 (EU) 23931 / 2 (EU) 233... (EU) 237... (EU) 265... (EU) GT1001 (RSA) GT2201 (RSA) G4... (IN) Mono-tube..... 55... (EU) G1...-> G2... (EU)
ORIGINAL Oil* (incl steering dampers) The original top quality gas pressurised or oil shocks for all passenger vehicles [includes Van-Magnum for medium commercial vehicles]	R1...-> R6... (EU & RSA) 14... (USA) Steering dampers..... *SA... (USA) *SC... (USA) *R3256... (RSA) *R2715 / 6... (RSA) *R1544... (EU)	10...->11... (EU) R7...->R8... (EU) R11... (EU)	MR... (EU)	R33... (EU) R37... (EU) R65... (EU) R2713... (RSA) R2714... (RSA)
GAS-MAGNUM Twin-tube gas Built off-road tough for our African conditions, specifically for LDVs and 4x4's for great off-road performance and on-road comfort at competitive pricing. + ADVENTURE Twin-tube gas Heavy duty (mainly) high pressure gas mono-tube for the connoisseur's 4x4 and SUV. Lightning fast reaction for a safer ride and better handling with reduced fade.	D1... (EU) D7...-> D9... (EU) D0031... (EU) D0032... (EU) D0033... (EU) D1102... (EU) M... (RSA) 34... (USA) 36... (EU) AU16... (AUS)	M00...-> M02... (RSA) D01...-> D05... (EU) AU36... (AUS)	M0801... (RSA) D08... (EU)	
ADVENTURE Mono-tube gas** Heavy duty (mainly) high pressure gas mono-tube for the connoisseur's 4x4 and SUV. Lightning fast reaction for a safer ride and better handling with reduced fade.	D06... (EU) Mono D2...->D6... (EU) Mono	Mono-tube D0001-> D0005... (EU) D0201 (EU)		
RANCHO Gas Ultra heavy-duty, tri-tube designs with tougher welding and mounting bushings for your 4x4. The RS9000 series is also 9-way adjustable for just the right setting for your off/on-road conditions.	RS999... (USA) adj RS5... (USA) non-adj RS55... (AUS) non-adj			
VAN-MAGNUM Oil* or gas The reliable heavy duty performer for heavy/ultra-heavy commercial vehicles that need to stay on the road.	V1...-> V2... (EU) Oil V6...-> V8... (EU) Oil V15... (EU) Twin-tube gas V25... (EU) Twin-tube gas V5... (EU) Mono-tube gas	V4... (EU) Oil V42... (EU) Oil V44... (EU) Oil V43... (EU) Twin-tube gas V45... (EU) Twin-tube gas	V3... (EU) Oil	
MAGNUM Oil* or gas The reliable heavy duty performer for heavy/ultra-heavy commercial vehicles that need to stay on the road.	65... (USA) 66... (USA) 74... (USA) T... (EU) B... (EU) F... (EU) CB... (EU) (cabin damper)			

Notes

- * Oil shock's piston rod will not automatically extend
- ** Do not fit Twin-tube (Gas-Magnum) & Mono-tube (Adventure) gas on the same axle
- *** Some AU... part numbers are twin-packed

PRODUCT WARRANTY

Monroe South Africa provides a 5-Year Limited Warranty (valid in South Africa) for the following genuine Monroe products:



MONROE® Intelligent Suspension RideSense Shock Absorbers

MONROE® OESpectrum Shock Absorbers

MONROE® Original Shock Absorbers

MONROE® Adventure Shock Absorbers

MONROE® Van-Magnum Shock Absorbers

MONROE® Gas-Magnum Shock Absorbers

MONROE® Springs

MONROE® Mounting Kits

MONROE® Protection Kits



RANCHO® Products



MONROE® MAGNUM Shock Absorbers

MONROE® MAX-LIFT Gas Springs

For Coverage Limitations, Process Requirements and specific Monroe warranty limitations visit the Monroe website.

EXCLUDED FROM WARRANTY

1. Claims where damaged mounting parts were used or reused such as rubber dirt shields, damaged bump stops, etc.
2. Monroe Ride-Levellers with air sleeve abrasion caused by incorrect mounting.
3. The warranty applies only if the original invoice for the part is provided to the dealer and the vehicle owner is the original purchaser.
4. Shock absorbers must be stored in horizontal position.
5. Cost of removal and installation is not included under warranty.
6. Normal wear and tear. All parts must be replaced in accordance with the vehicle manufacturer's recommended service schedule.
7. Any issues that occur due to the part not being fitted by a professional installer.
8. Products which have been modified or damaged by improper installation and/or use of incorrect installation tools, contrary to the specifications of the vehicle manufacturer and/or DRiV.
9. Product damage caused by accident(s).
10. Products damaged by installation on any other vehicle/ engine than indicated in the DRiV catalogue or its subsequent amendments.
11. Products that have been subject to misuse (racing and rally sport purposes, off-road usage with light vehicle (if not SUV's) unless a product it's explicitly deemed for such usage, accidental damage, incorrect installation, improper or untimely maintenance, or improper application.
12. Reconditioned or recycled products.
13. Inappropriate storage of the part: it is a requirement that parts are stored in dry and cool warehouse conditions.
14. Products that are past any expiration date that is mentioned on the product packaging.
15. Products affected by damage during transportation.
16. Prior to settlement of a claim, DRiV reserves the right to examine all related DRiV and non-DRiV parts involved.
17. This warranty does not affect your statutory rights.

ADDITIONAL 5 YEARS WARRANTY LIMITATIONS (for the regions where applicable)

1. Where shock(s) are not installed in accordance with Monroe's recommendations:
 - Both shock absorbers of one series (Original, OESpectrum) must be replaced on the same axle at the same time (except Monroe Intelligent Suspension RideSense).
 - Where applicable, Protection Kits (PK) and Mounting Kits (MK) must also be replaced at the time of the fitting. Claims against Monroe shock absorbers installed with old or previously damaged Protection Kit (PK) and Mounting Kit (MK) are excluded.

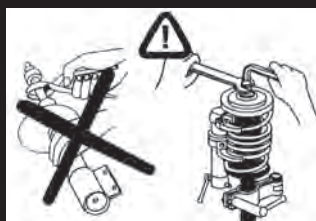

MOUNTING KIT



PROTECTION KIT



MONROE®



Product and brand information: www.monroe.com/en-za
Garage Gurus Technical Support: www.garagegurus.tech/en-eu
For email contact: support@gurusoncall.tech

Customer services Sub-Saharan Africa:

General : 080 900 1850 , or email customerservicesSSA@driv.com
Technical : +27 (0)0800 981 291

QUICK
TO MARKET

FIRST
TO MARKET



FOR WARRANTY, VISIT WWW.MONROE.COM/EN-ZA/

